

EVER BAMBOO®

A perfect replica of natural bamboo

TAKE GAKI

Natural bamboo and traditional craftsmanship

HIGHLY
AUTHENTIC

QUALITY
FROM JAPAN

*The essence
of Japan*

和
の
趣

Invite a beautiful
seasonal breeze
to the home.

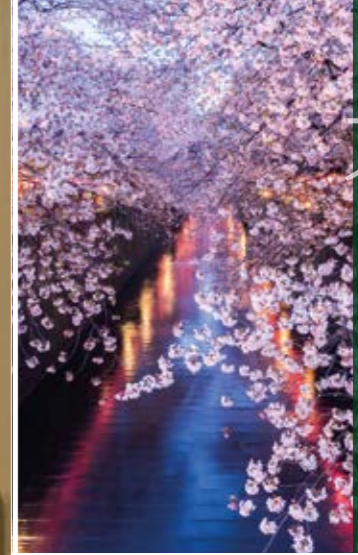

春

SPRING

The gentle fragrance of a flower beginning to open in the garden, spring is already here.



夏

SUMMER

Breeze is like peace, a swaying song it sings, drifting away in the summer wind, dancing across green fields.



秋

AUTUMN

Time is filled with a hurried dusk. The trees begin to colour and foretell the deeper seasons.



冬

WINTER

Trees spread their roots to the earth and people expand their minds to the new season.



Exterior and facades



ARTPORT® - Carports



Entrance area & front garden



Japanese garden culture



Atmospheric lighting



Terrace roofing



Garden rooms



Fences and visual protection

5th ROOM®

Concepts and products for your building and garden

There are many encounters with the environment around buildings for every person every day. People meet fellow human beings or enjoy the connection with nature in the garden. In Takasho's product world, these areas form the "5th ROOM" as an important part of the daily living space, alongside the living areas with kitchen, living room, dining room and bedroom.

Through the harmonious arrangement of the "5th ROOM", from the entrance area to façade and fence elements or rooms in the garden to the atmospheric lighting, all 5 senses of residents and guests are addressed. This creates an atmosphere that invites people to

spend time there by day and by night and fosters a state of well-being.

Inspired by Japanese garden culture with the meaning of the seasons and the elements of wind, light, water and greenery, Takasho has developed a range of matching products for this purpose, which can be ideally combined with each other, especially in the combination of building and garden design.

Takasho supports architects, planners and end customers from the very beginning in the development of suitable harmonious overall concepts to the execution of elegant solutions.





The product series

- EVER ART WOOD®**
Laminated aluminium profiles
- EVER ART BOARD®**
Laminated aluminium composite panels
- EVER BAMBOO®**
A perfect replica of natural bamboo
- TAKE GAKI**
Traditional craftsmanship & premium quality
- LEDIUS**
Extra-low-voltage lighting system for garden & exterior
- ARTPORT®**
Aluminium in wood design for the carport

... offer tailor-made solutions for

- Facade, ceiling or wall claddings
- Room solutions for terraces and garden canopies
- Fences & visual protection
- Garden & outdoor lighting
- Gates, entrance areas and enclosures
- Carports
- A wide range of accessories

Product specifications

-  Products with single-sided design
-  Products with double-sided design
-  For indoor and outdoor use
-  For indoor use only

Material labels

-  Products made from Acrylonitrile styrene acrylate
-  Products made from Styrene acrylonitrile
-  Products made of weather-resistant acrylonitrile-ethylene-styrene
-  Products made from Acrylonitrile butadiene styrene
-  Products made from natural materials
-  Products made from Polypropylene
-  Products made from polypropylene
-  Products made from Aluminium
-  Fibre-reinforced plastic
-  Products made from ceramic materials



EVER BAMBOO®

Create an atmosphere where you feel comfortable and want to spend time. Perfectly balanced concepts and elegant solutions for home and garden with the EVER series products.

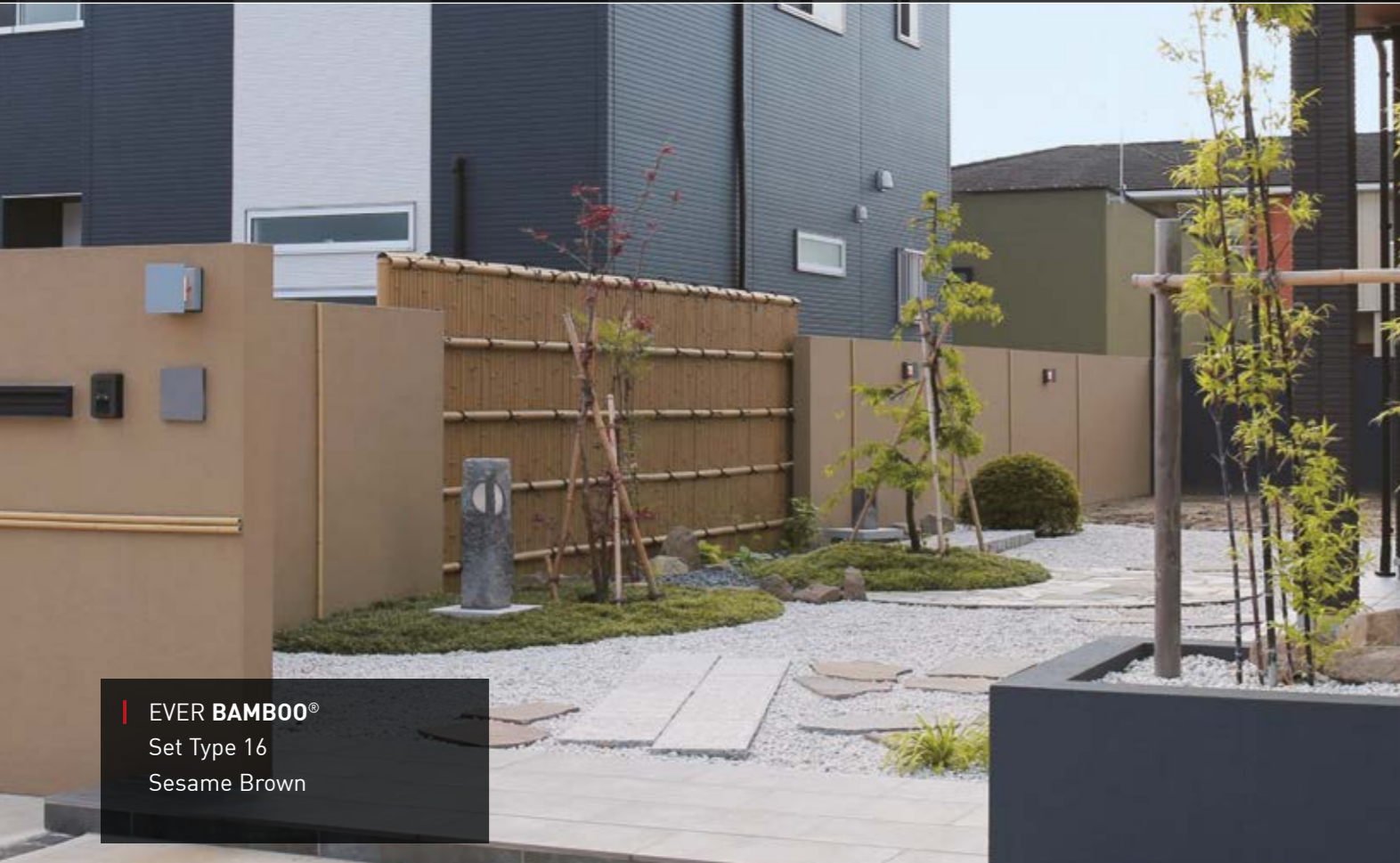

EVER BAMBOO®
Set Type 16
Sesame Brown

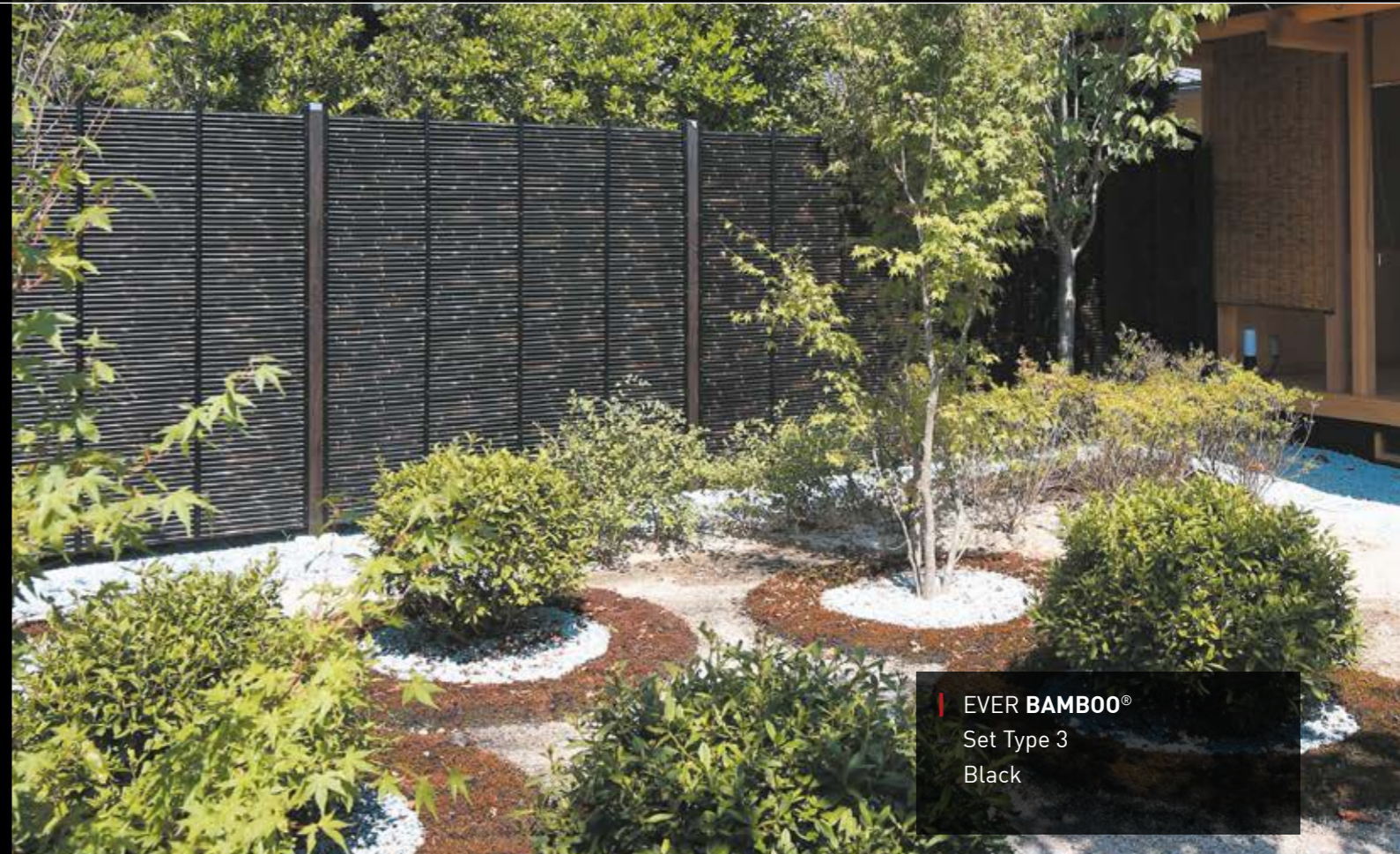

EVER BAMBOO®
Set Type 3
Black

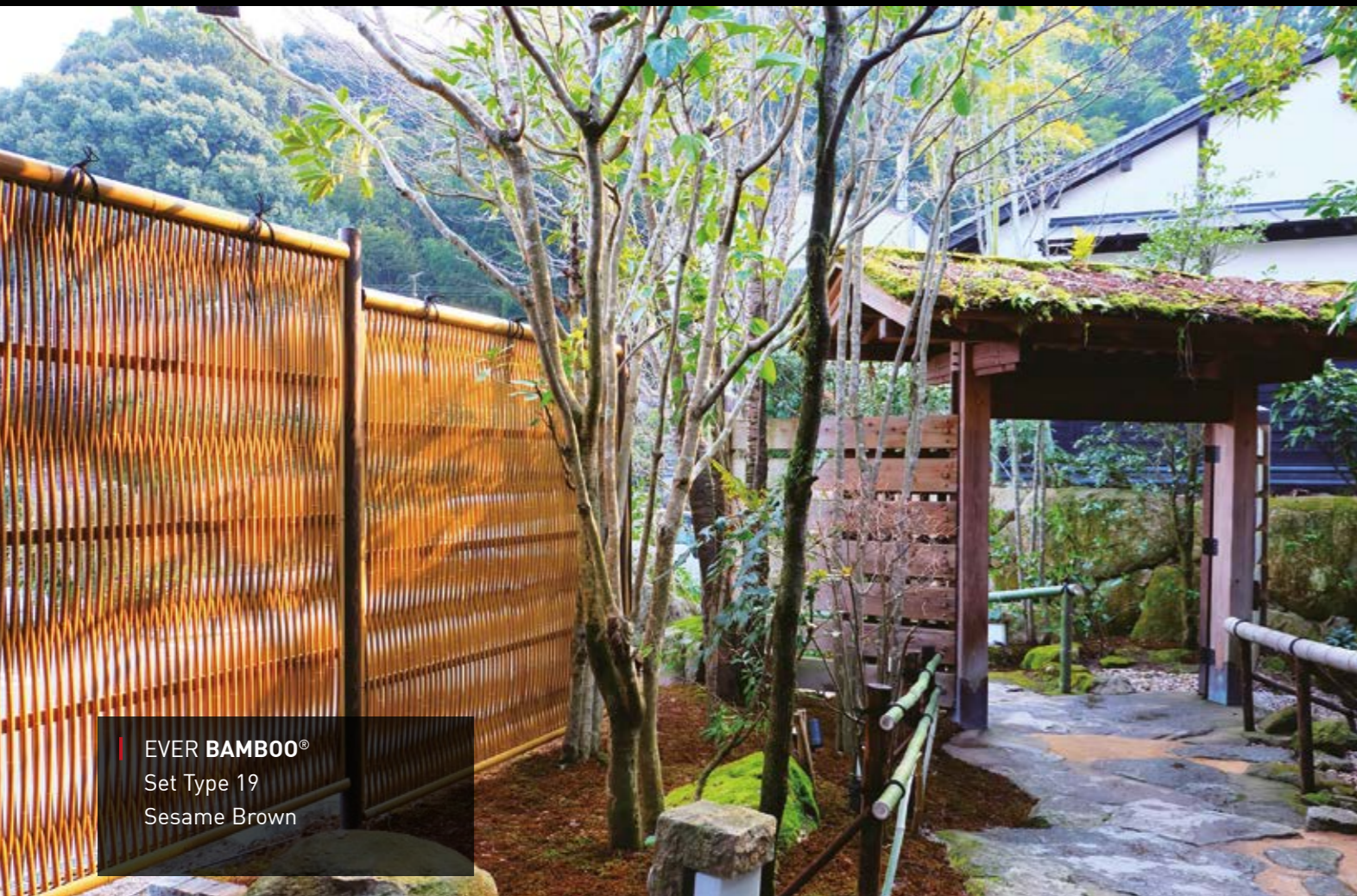

EVER BAMBOO®
Set Type 19
Sesame Brown



EVER BAMBOO®
Set Type 22
Brown

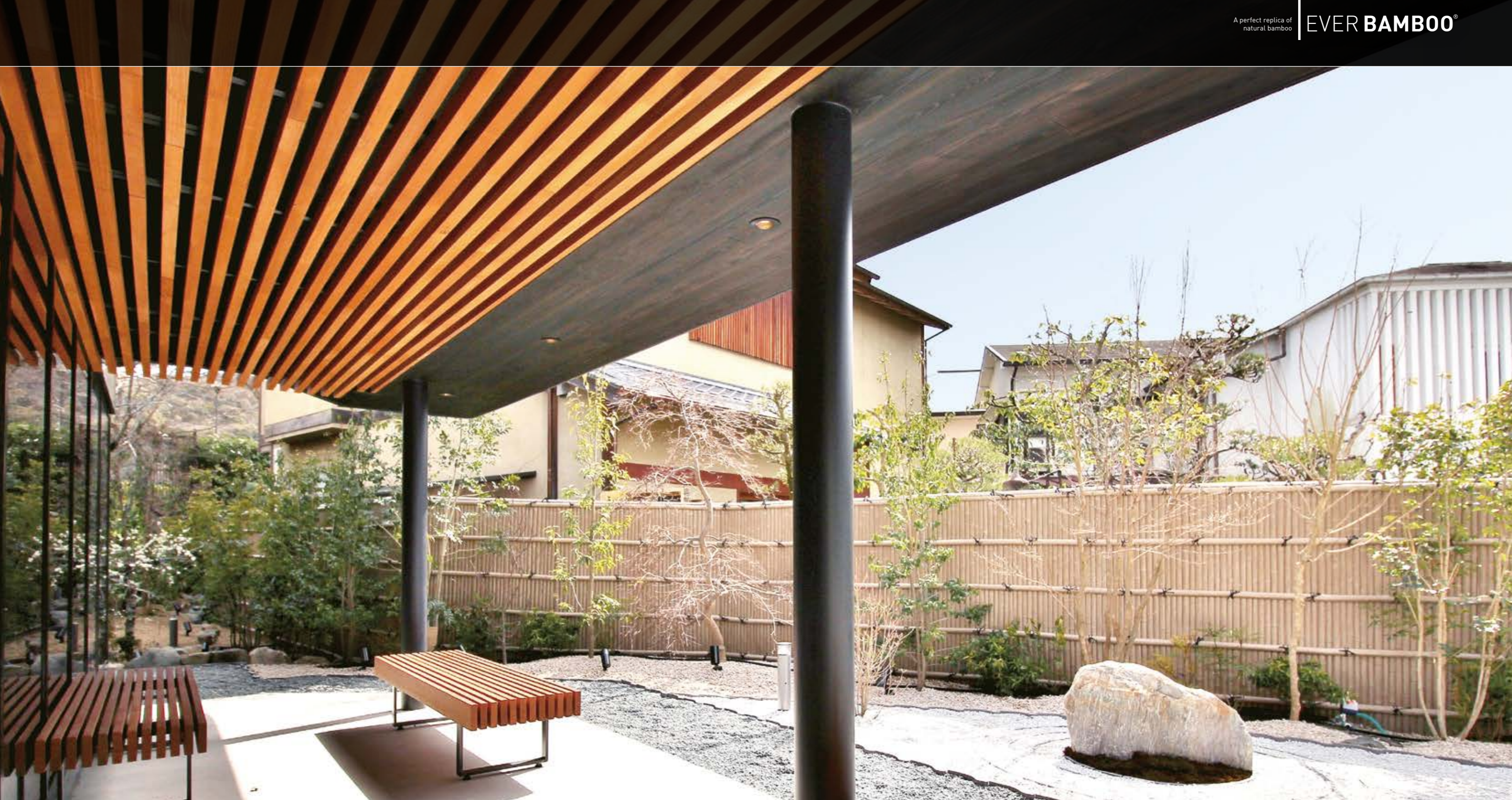

EVER BAMBOO®

Create an atmosphere where you feel comfortable and want to spend time. Perfectly balanced concepts and elegant solutions for home and garden with the EVER series products.

Emphasis and texture

Transform your garden into an environment with an impressive atmosphere in traditional Japanese style. EVER BAMBOO® was created for this purpose, following the highest quality standards.





EVER BAMBOO®
 Kenninji Standard Panel
 ECO BAMBOO Stick
 Old Yellow



EVER BAMBOO®
 ECO BAMBOO
 Transparent

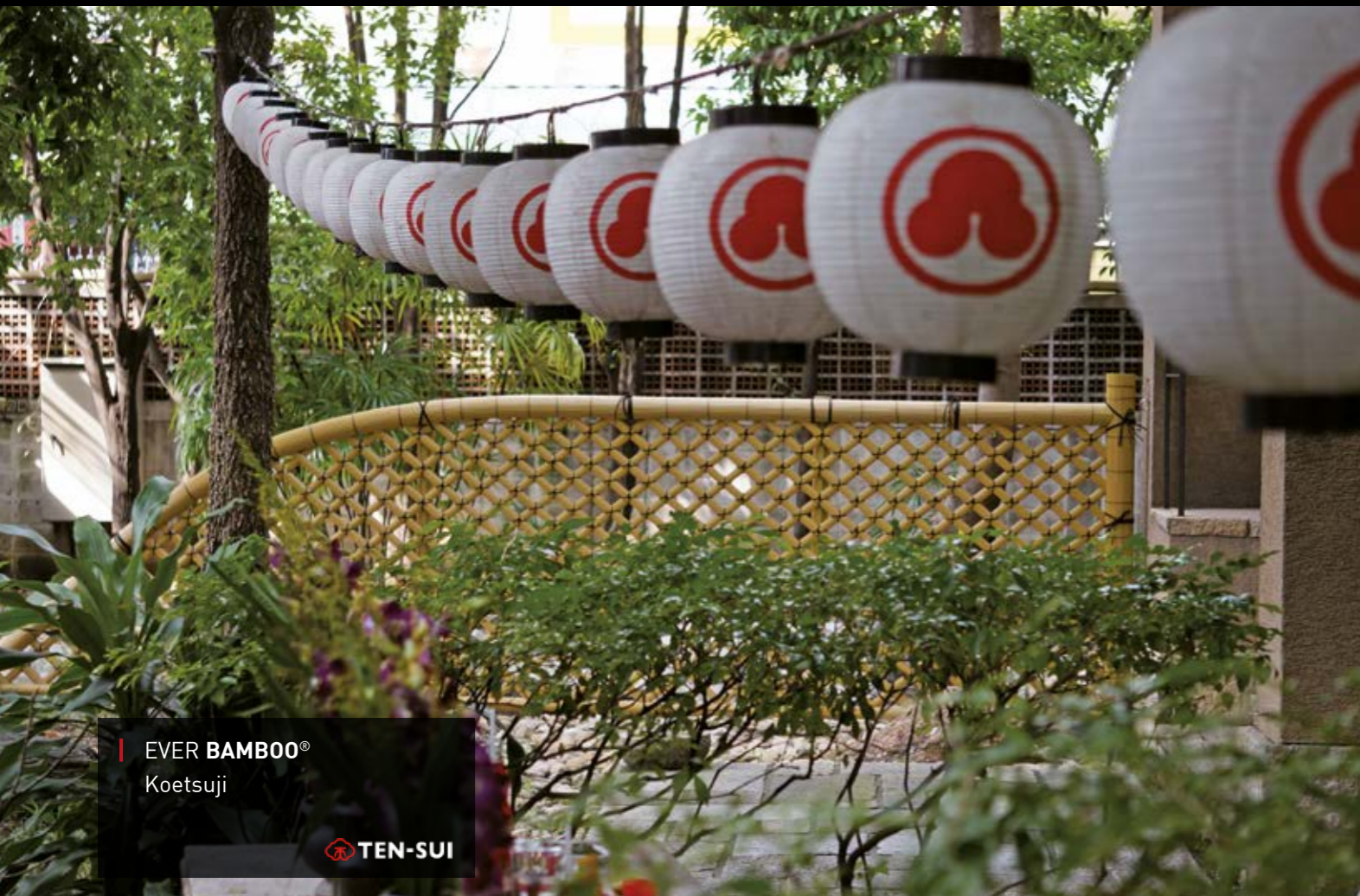

EVER BAMBOO®
 Koetsuji



EVER BAMBOO®
 Set Type 5
 Ivory Exposed

EVER BAMBOO®

Create an atmosphere where you feel comfortable and want to spend time. Perfectly balanced concepts and elegant solutions for home and garden with the EVER series products.

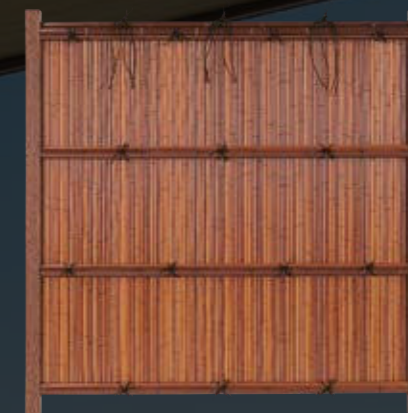

Finest details

Natural colour tones interact with three-dimensional shapes to create beautiful surfaces that convey a sense of understated sophistication and perceptible expressiveness. In this way, the meaning of the Japanese "Wabi-Sabi" concept becomes visible in the products.



EVER BAMBOO®
Antique Exposed



EVER BAMBOO®
Set Type 5
Yellow

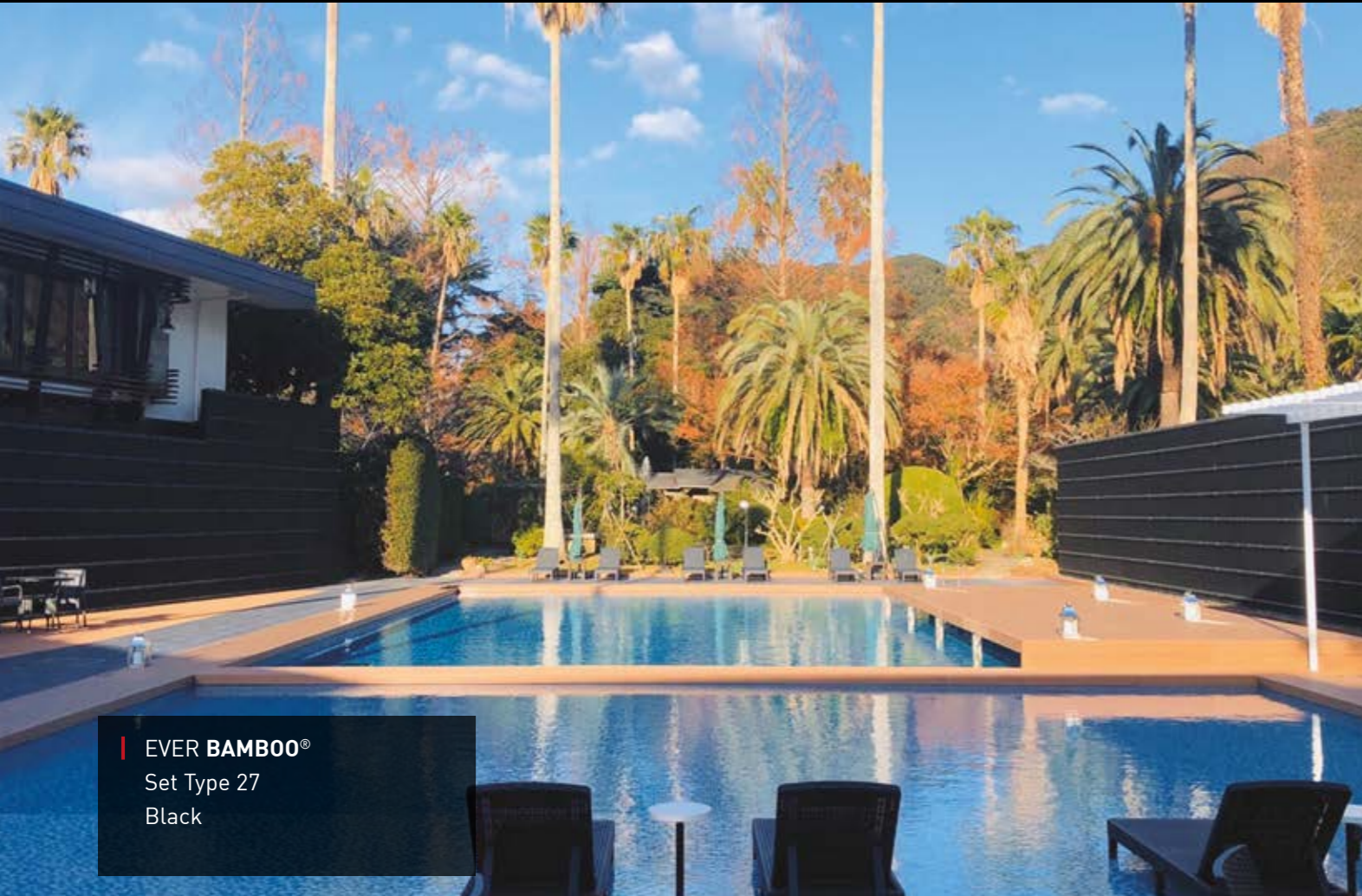

EVER BAMBOO®
Set Type 27
Black



EVER BAMBOO®
Set Type 17
Antique Exposed



EVER BAMBOO®
Set Type 5
Black



EVER BAMBOO®
Set Type 4, Koetsuji
Yellow



EVER BAMBOO®
Set Type 1
Yellow



10 YEARS WARRANTY

- on 1. the fading of the colour
- and 2. to the cracking of the panels

EVER BAMBOO®

EVER BAMBOO® combines the benefits of the latest technology and materials with the proven techniques of traditional craftsmanship. This gives the panels made of specially reinforced ASA resin numerous advantages that enable a wide range of applications. At the same time, the atmosphere of natural bamboo is preserved.

Durability

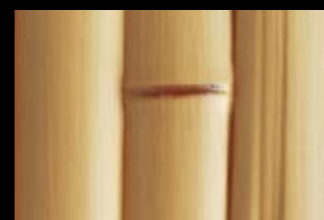

The high quality of EVER BAMBOO® ensures that the finish of the surfaces is not affected by temperature changes, rain and sunlight.

Texture



The three-dimensional structure creates subtle shadows and a surface that is close to nature.

Material



The strong material guarantees maximum stability and lasting weather resistance.

Design



The finishing touches are perfected by hand without any compromise on detail.

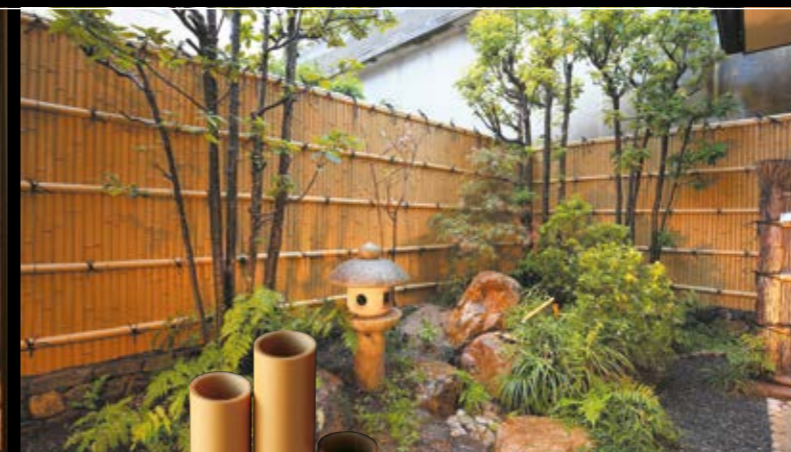

DELUXE ARTISAN BAMBOO

Like with our "ECO BAMBOO", we have faithfully recreated the expressiveness of natural bamboo while incorporating the techniques of traditional artisan craftsmen, culminating in our "DELUXE ARTISAN BAMBOO". The character of each individual bamboo section and knot is replicated here in an impressive way.



ECO BAMBOO DELUXE

The wonderful characteristics of natural bamboo are faithfully reproduced using environmentally friendly materials. The special expression of each individual section is meticulously portrayed from beginning to finish. Certain sections of the bamboo have been finished by hand by our craftsmen, to deliver a perfect replica of natural bamboo.

ECO BAMBOO



黒竹

Black

The toned black lines of Black Bamboo create a polished, crisp impression. Subdued and tasteful, yet with a contemporary, modern feel. Takasho panels deliver deep, delicate colours and rhythmical three-dimensional textures. Every beautiful detail has been carefully replicated.



Sarashi

さらし

Takasho's careful attention to detail is thoroughly demonstrated in the shape, form, and colour tones of our bamboo. In particular, the multihued colour tones of the bamboo add a sense of subdued refinement known as "Wabi-Sabi." Takasho is proud of the techniques that we have refined and perfected over many years, culminating in the most realistic bamboo reproductions available on the market.

EVER BAMBOO® will never compromise

in its commitment to detail.



Antique

古竹

Our Antique Bamboo panels have been carefully created to reproduce the seasoned appearance of aged bamboo, which would usually take many years to achieve. In comparison to Yellow Bamboo, Antique Bamboo adds an extra depth of flavour to create a highly dignified space of understated beauty.



あじろ Ajiro

Distinctive yet delicate young bamboo shoots have been woven together to create beautiful shadows that resonate with depth of colour. From whichever angle you view the panels, the three dimensional shape of the carefully wickered bamboo emits soft shadows and subtly changing colours, to create a feeling of unique elegance and luxury. Our Ajiro panels are a faithful reproduction of this ornate pattern with all its subtleties.

Entry

Standard

Premium

Kenninji Deluxe



Real Yellow Antique



Real Exposed Antique Exposed Sesame Brown Real Green

Kenninji Standard



Yellow Green



Old Yellow Yellow Exposed Green Exposed



Spot Yellow

Kenninji Traditional

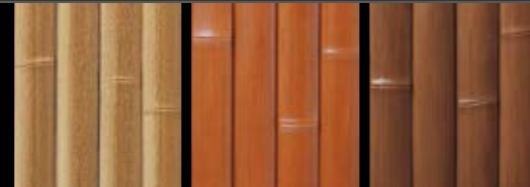

Brown Light Brown Dark Brown

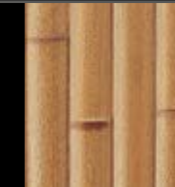

Brown Exposed

Bamboo Stick Panels

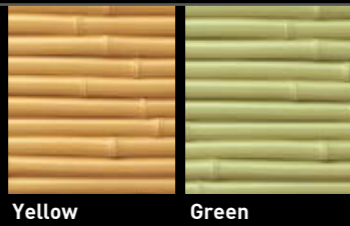

Yellow Green



Old Yellow Green Exposed Black

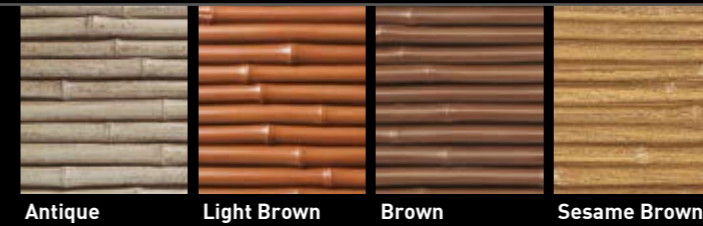

Antique Light Brown Brown Sesame Brown

Bamboo Pole



Yellow Green



Old Yellow Yellow Exposed Green Exposed



Sesame Brown Sesame Brown Exposed

Ajiro



Ajiro Yellow



Ajiro Brown Ajiro Young Ajiro Dark Brown

Kyo-an



Yellow Kyo-an Lattice Yellow



Kyo-an Exposed Kyo-an Dual Kyo-an Lattice Exposed

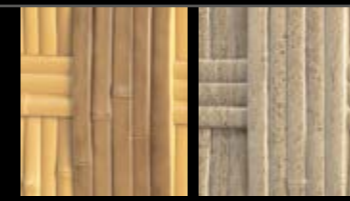

Kyo-an Lattice Dual Kyo-an Lattice Antique

Uni Bamboo



Yellow Yellow Exposed

Natural colours

The variety of colour tones is faithfully made to match different types of bamboo. Surfaces aged by wind and weather can also be reproduced, as can bamboo that has been refined using traditional methods.

Realistic surfaces

The bamboo structure is shaped with great attention to detail and precision, following nature's example. Three-dimensional and hand-painted details create the special natural impression of the EVER BAMBOO® series.

Classic themes

With a wide range of traditional patterns, EVER BAMBOO® panels offer numerous design options for classic or also modern Japanese-style gardens.

EVER BAMBOO®

EVER BAMBOO® MATERIAL

Beautiful natural appearance

A bamboo fence is an essential part of any traditional Japanese garden. However, it can be difficult to preserve the beauty of real bamboo. To overcome these difficulties, we have developed our EVER BAMBOO® product range, which meets all requirements while offering good resistance to mould, corrosion and discolouration and therefore preserves its beauty permanently.

Subtle 3D contours

The three-dimensional textures create fine contours that set beautiful accents on the surface of the bamboo fence that change with the movement of the light.

Realistic section knots

The unique texture and surface of natural bamboo is carefully reproduced to faithfully reflect the fine grain and characteristics. Each individual piece of bamboo embodies its own rich expression, representing sophisticated emotion and harmony.

Durable and sustainable



EVER BAMBOO® incorporates recyclable special reinforced ASA resin as a raw material, which is friendly to the global environment. This special material is durable against rain and sunlight, giving resistance to corrosion and discolouration, and features a proven longevity.

Highly workable

Extremely robust and at the same time pliable and flexible for easy handling and processing.

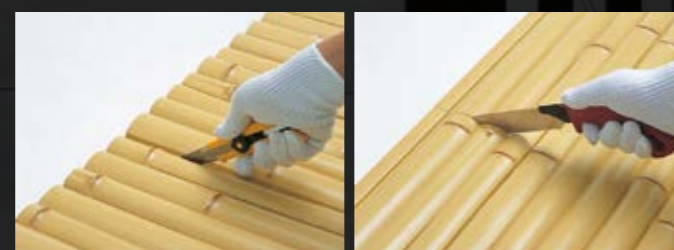

Kenninji Standard Panels



Kenninji Traditional Panels



Dimensions (mm)

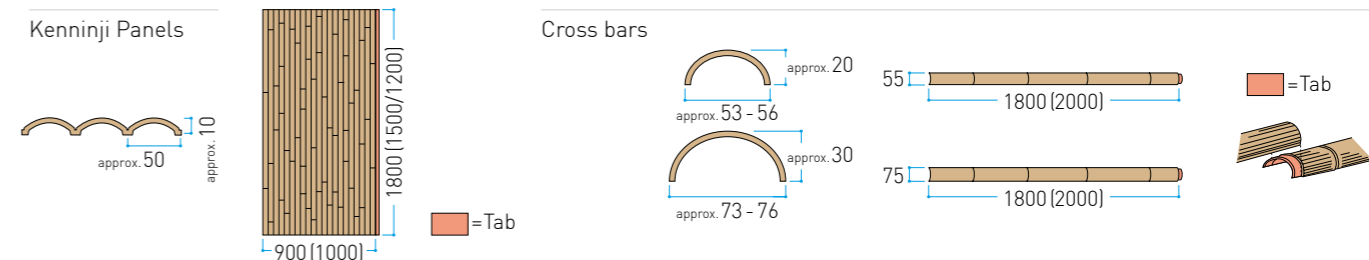

EVER BAMBOO® MATERIAL

Kenninji Deluxe Panels



Dimensions (mm)

Kenninji Panels

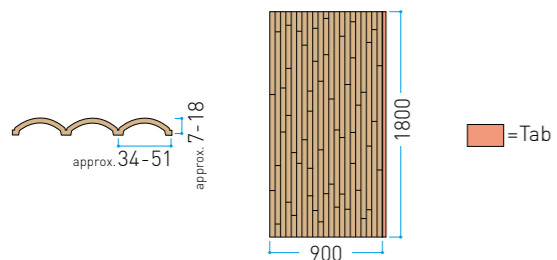

Cross bars

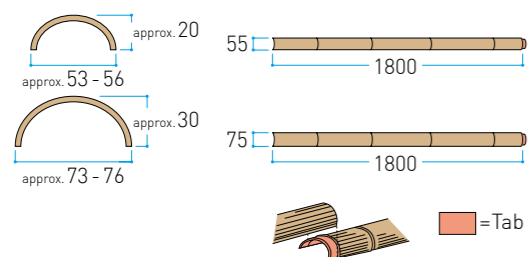

Kyo-an Panels



Dimensions (mm)

Kyo-an Panels

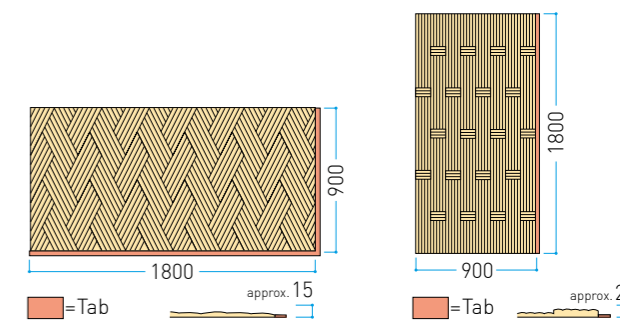

Cross bars

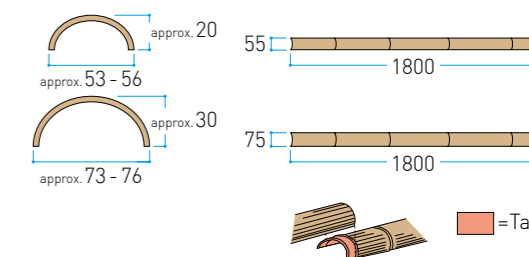

EVER BAMBOO® MATERIAL

Ajiro Panels

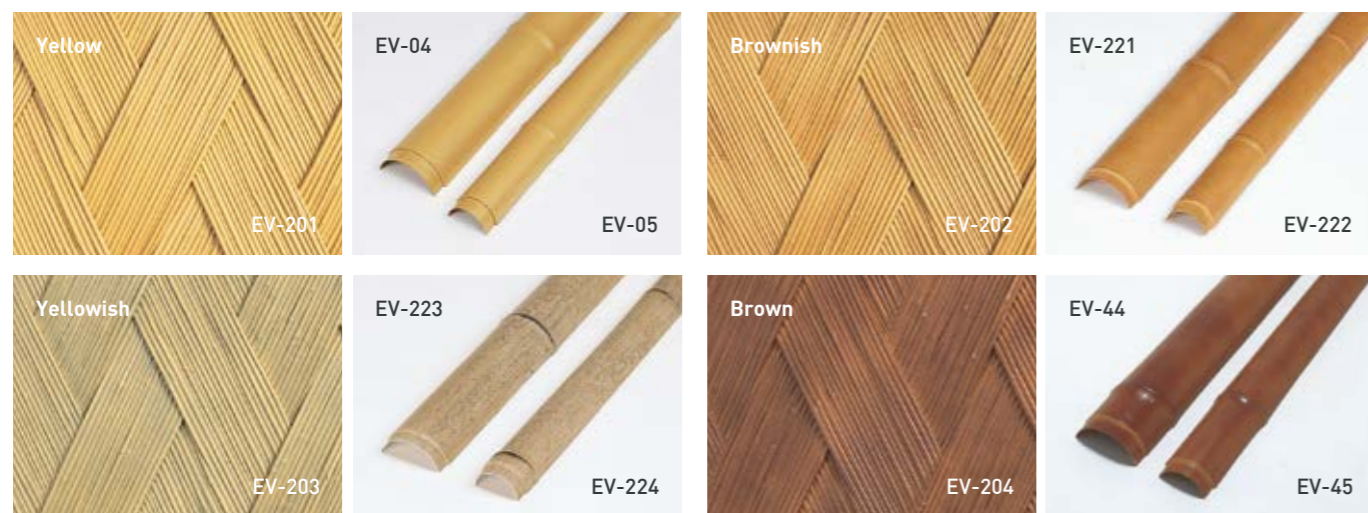

Dimensions (mm)

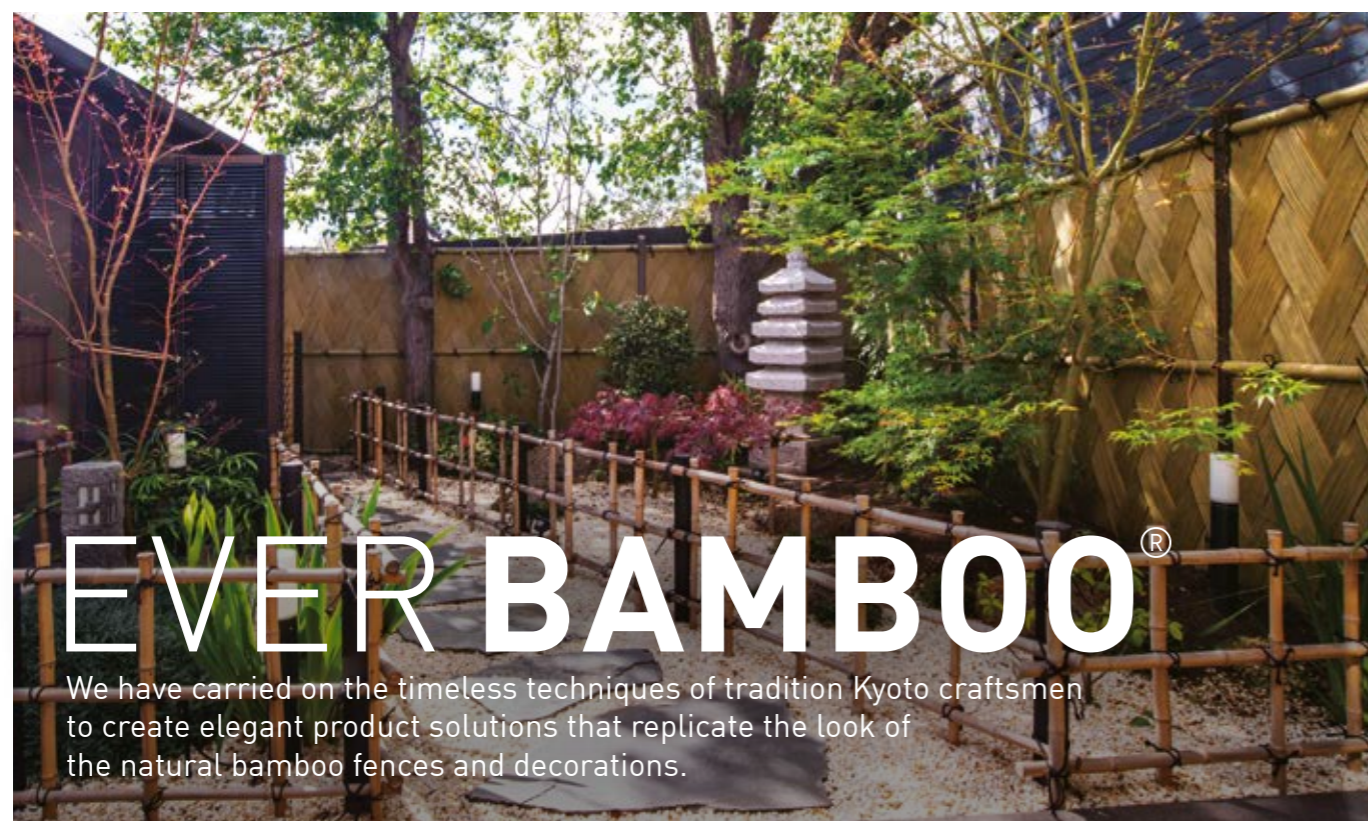
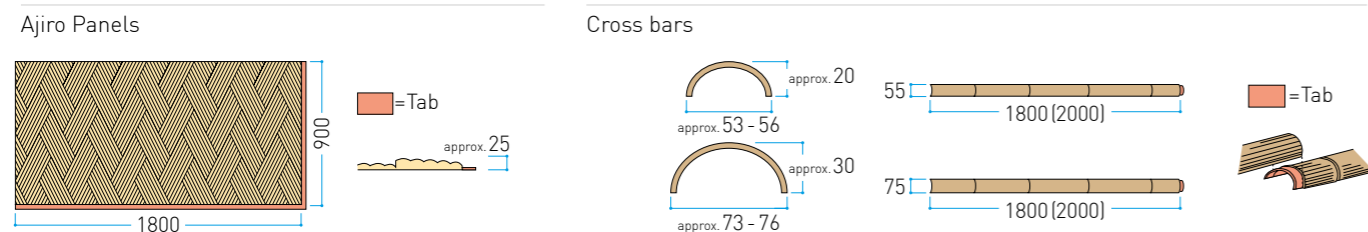

EVER BAMBOO®

We have carried on the timeless techniques of tradition Kyoto craftsmen to create elegant product solutions that replicate the look of the natural bamboo fences and decorations.

Bamboo Stick Panels

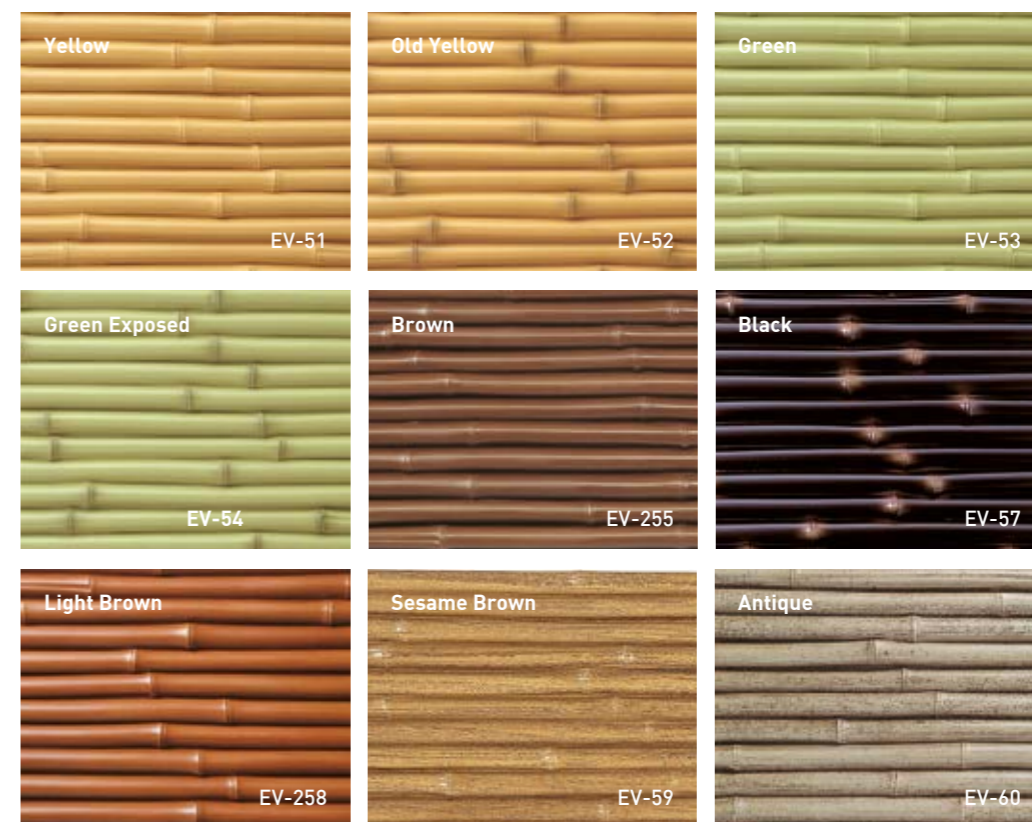

Dimensions (mm)

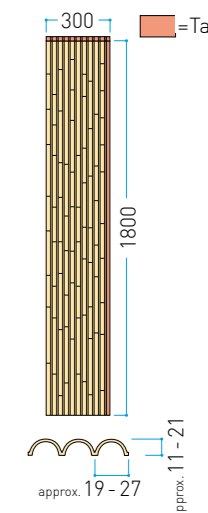

Bamboo Pole Panels



Dimensions (mm)

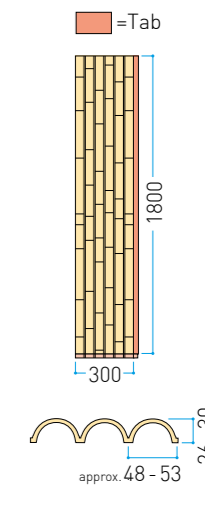

EVER BAMBOO® MATERIAL



With the excellent material properties of our sticks, unique fences are completely freely constructible, just like with natural bamboo.

Premium Details

Each sectioned knot is uniquely different to deliver a beautiful, natural appearance. Choose from our highest-quality DELUXE **ARTISAN BAMBOO** with hand-painted section joints, our DELUXE **ECO BAMBOO**, also with finely crafted section joints, or our Standard **ECO BAMBOO**, which delivers excellent cost performance.

Superior technique

Three-dimensional surfaces of the sticks create subtle shadows. The ASA and ABS resins used make the material strong, light and durable at the same time. Our products are also environmentally friendly as they contain no polyvinyl chloride (PVC).

Highly realistic

The beautiful texture and feel of natural bamboo has been carefully perfected to faithfully reproduce every fine grain and characteristic.



EVER BAMBOO®

We have carried on the timeless techniques of tradition Kyoto craftsmen to create elegant product solutions that replicate the look of the natural bamboo fences and decorations.

EVER BAMBOO® MATERIAL

ECO BAMBOO DELUXE



An environmentally-friendly, quality-oriented double structure



ABS special reinforced resin is highly resistant to mechanical impact

ASA special reinforced resin with excellent resistance to weather, heat changes and discolouration.

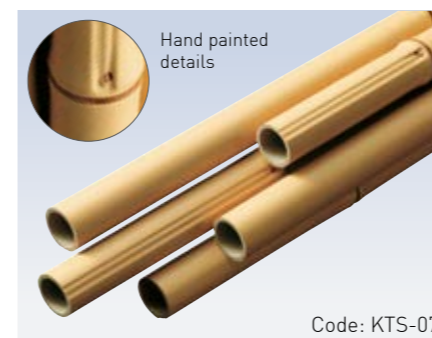

Artisan Yellow



Ivory Exposed



Olive Green



Deluxe Yellow



Ivory

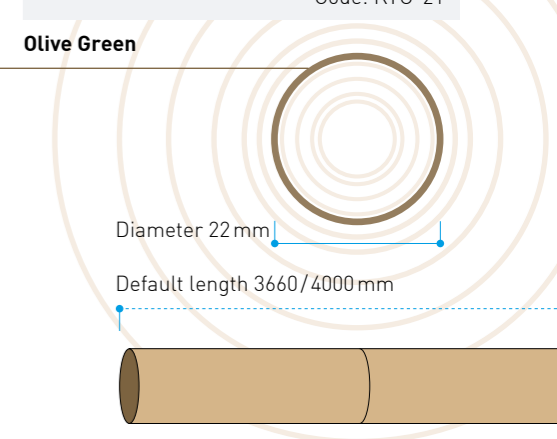

ECO BAMBOO

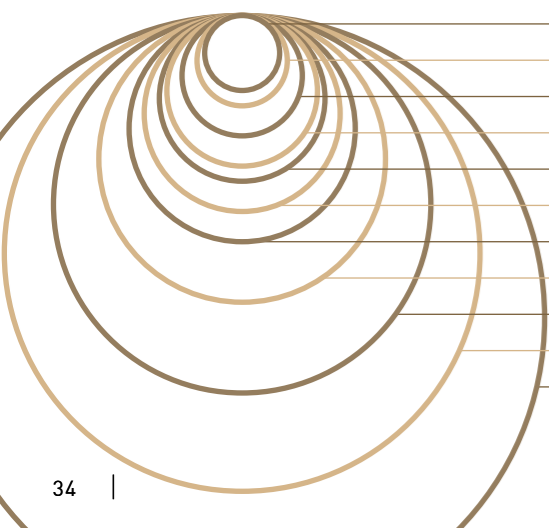
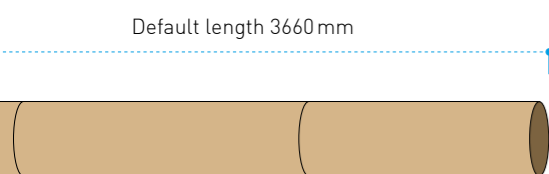

	Yellow	Green	Sesame Yellow	Light Brown	Dark Brown	Black	Transparent*
Ø 10 mm	•	•	•	•	•	•	
Ø 13 mm	•	•		•	•		
Ø 16 mm	•	•	•	•	•	•	•
Ø 20 mm	•	•	•	•	•	•	•
Ø 22 mm	•	•	•	•	•	•	•
Ø 26 mm	•	•	•	•	•	•	•
Ø 30 mm	•	•	•	•	•	•	•
Ø 38 mm	•	•	•	•	•	•	•
Ø 50 mm	•	•	•	•	•	•	•
Ø 63 mm	•	•	•	•	•	•	•
Ø 80 mm	•	•	•	•	•	•	•
	Code: ASY	Code: AIA - „Ø“B	Code: ASN	Code: ABS	Code: ABT	Code: AIA-„Ø“k	Code: AGA

*Material: Polycarbonate



EVER BAMBOO® MATERIAL

Split Bamboo Sticks



Flat profile round

Yellow Sesame Yellow Light Brown Dark Brown Green

• • • • •

ASW-40Y ASW-40N ASW-40T ASW-40S AIA-40B

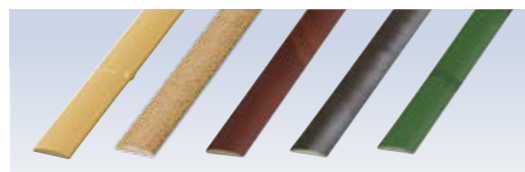

Flat profile strip

Yellow Sesame Yellow Light Brown Dark Brown Green

• • • • •

ASW-25Y ASW-25N ASW-25T ASW-25S AIA-25B

Yellow Light Brown Dark Brown Black Sesame Yellow

• • • • •

• • • • •

• • • • •

ASH-0"Y ASH-0"S ASH-0"T ASH-0"K ASH-0"N

Yellow Light Brown Dark Brown Sesame Yellow

• • • •

• • • •

• • • •

ASC-0"Y ABC-0"S ABC-0"T ASC-0"N

Half round profile



C - Profile round

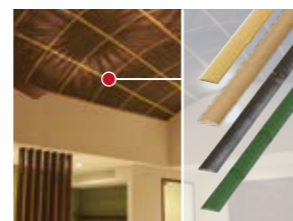
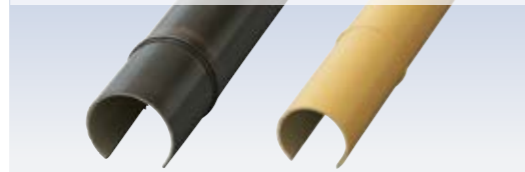

W 25 mm

W 40 mm

Ø 50 mm

Ø 63 mm

Ø 80 mm

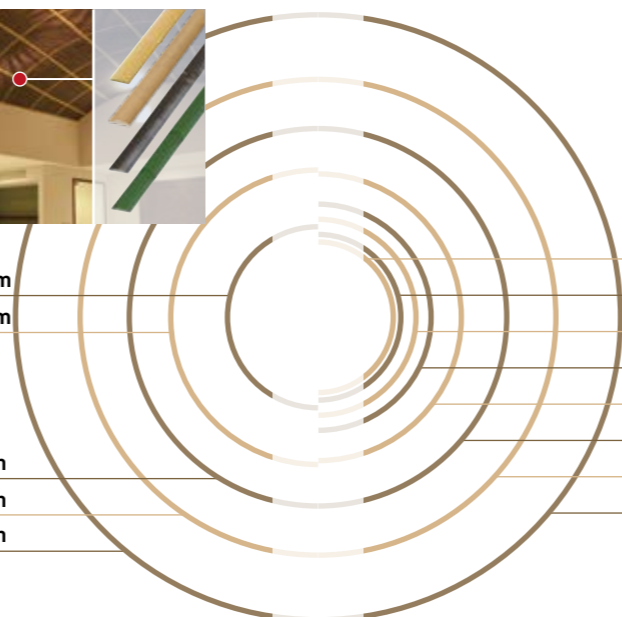

Diameter Ø 25 - 80 mm

Default length 3660 mm



End caps available for all ECO Sticks and cross bars

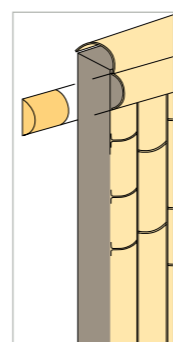
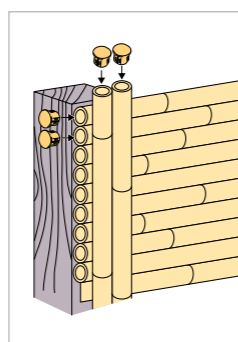

Connecting pieces

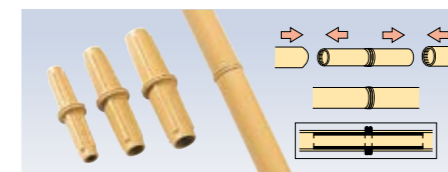

ECO BAMBOO Connector



Aluminium pipe for reinforcement

for Ø 20 mm

for Ø 22 mm

for Ø 26 mm

for Ø 30 mm

for Ø 38 mm

for Ø 50 mm

for Ø 63 mm

for Ø 80 mm

PJ-22 Ø 18 mm x L 90 mm

PJ-26 Ø 22 mm x L 100 mm

PJ-30 Ø 26 mm x L 110 mm

AMP-20S Ø 15 mm x L 3700 mm

AMP-22S Ø 17,5 mm x L 3700 mm

AMP-26S Ø 21 mm x L 3700 mm

AMP-30S Ø 24 mm x L 3700 mm

AMP-38S Ø 33 mm x L 3700 mm

AMP-50S Ø 44 mm x L 3700 mm

AMP-63S Ø 56 mm x L 3700 mm

AMP-80S Ø 72,5 mm x L 3700 mm

Shuro ropes UV-resistant and weatherproof



Roll

Code	Size
STF-32	Ø 3 mm x 340 m rope
STF-42	Ø 4 mm x 250 m rope

Bundled

Code	Size
STF-315	Ø 3 mm x 15 m rope
STF-415	Ø 4 mm x 15 m rope

Pre-tied Knots

Code	Size
OS-11	Ø 75 mm for the top cover
OS-12	Ø 55 mm for the top cover
OS-13	Ø 55 mm for the crossbars

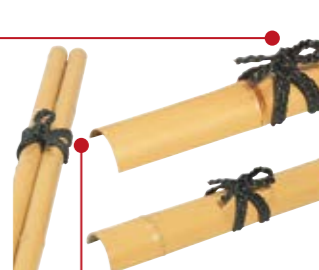
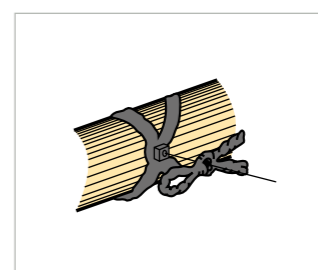
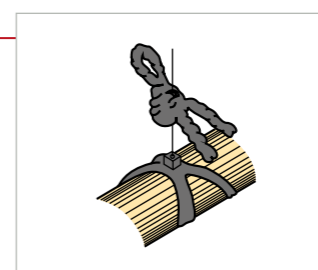

One-Touch Knots

Code	Size
OS-10	for 2 Sticks of Ø 26 mm
OS-21	for Ø 55 mm
OS-06	for Ø 63 mm
OS-05	for Ø 75 mm

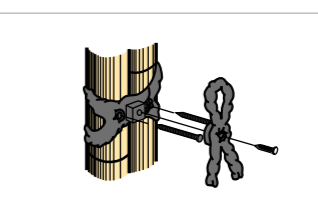

One-Touch Knots

Code	Size
OS-09	for 2 Sticks of Ø 22 mm
OS-08	for Ø 50 mm
OS-07	for Ø 55 mm

EVER BAMBOO® SET



EVER BAMBOO®

We have carried on the timeless techniques of tradition Kyoto craftsmen to create elegant product solutions that replicate the look of the natural bamboo fences and decorations.

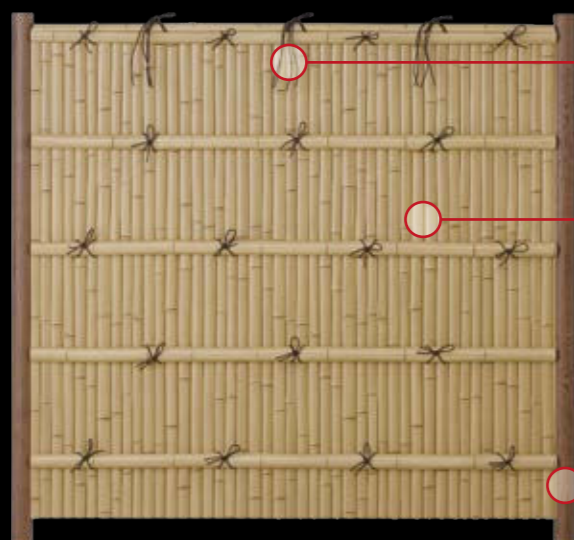

All inclusive assembly kit

All components needed to create a fantastic bamboo fence are processed and packed as a set.

Modular system

Depending on your needs, mounting sets are available for two different module types: The 'base' type, with two posts, is suitable for installation as a free stand-alone fence element, while the 'extension' type is used to expand your fence to the desired length. We offer a choice of single or double panelled versions for the modules. Select the type that best suits your design.

Visible & covered posts

Select from either visible posts or covered posts in accordance with the spatial clarity and continuity of your fence design.

System

Basic module

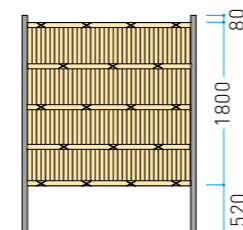

Extension module

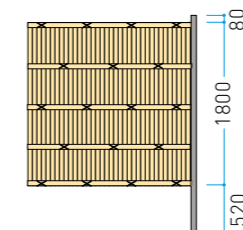

Visible posts

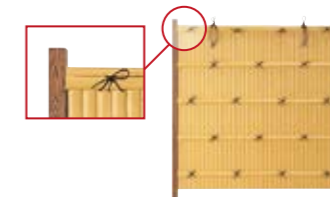

Covered posts

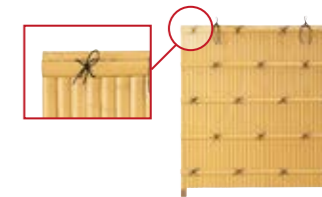

Assembly

BAMBOO Modular units

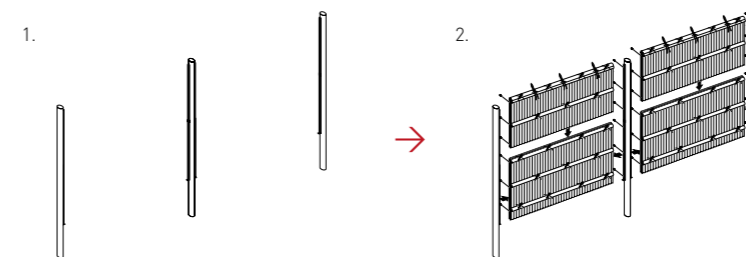

1. Positioning the posts
2. The pre-assembled bamboo panels are mounted on the posts

UNI BAMBOO

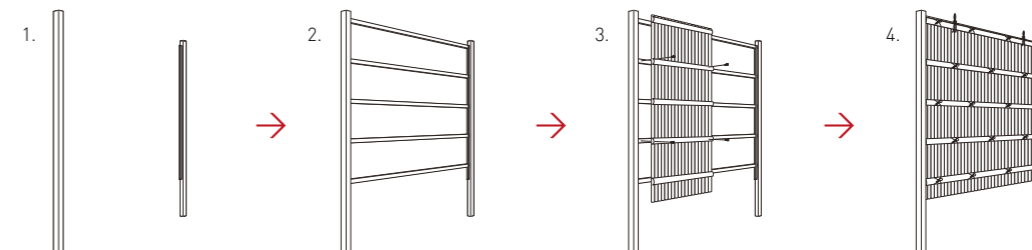

1. Positioning the posts
2. The horizontal sections build up a frame
3. The bamboo panels are mounted to the frame
4. Finally, the One-Touch Shuro knots are attached

Default Panels

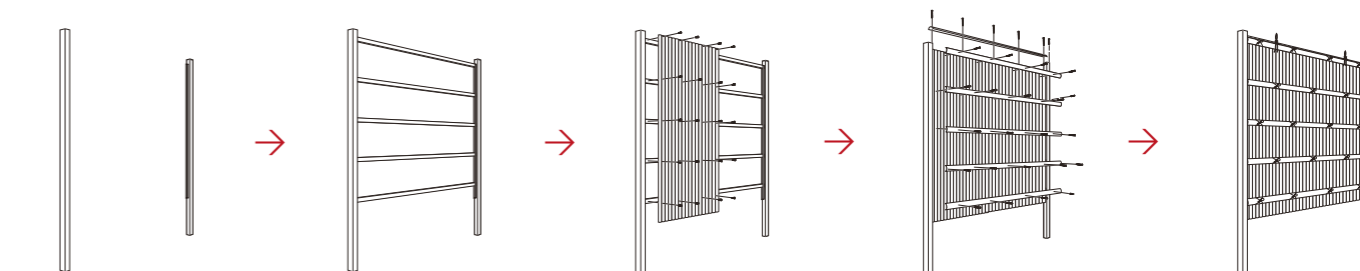

1. Positioning the posts
2. The horizontal sections build up a frame
3. The panels or sticks are mounted on the frame
4. The covers and crossbars are attached
5. Finally, the classic knots of Shuro rope are fastened

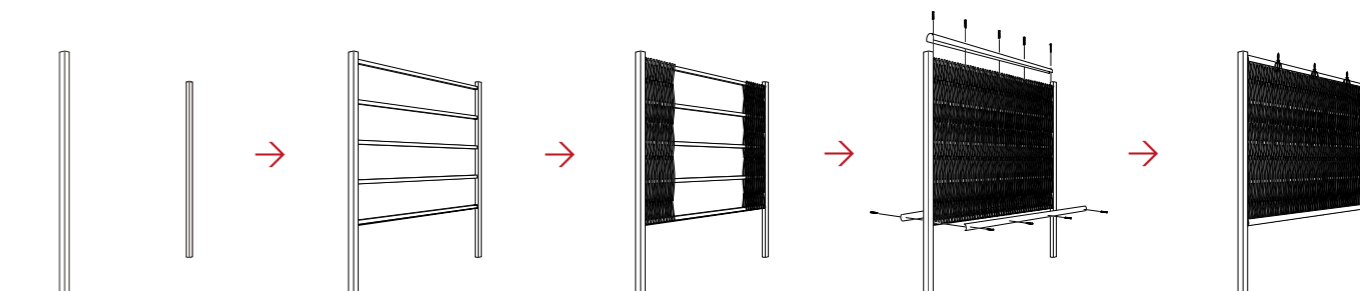

Tube panels

EVER BAMBOO® SET

Kenninji Standard Panels

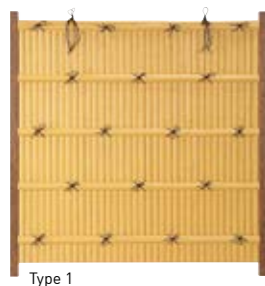

Type 1



Type 2

EVER BAMBOO® Set – Type 1
visible posts
Basic module: W 1920 x H 1800 mm
Extension: W 1860 x H 1800 mm

EVER BAMBOO® Set – Type 2
covered posts
Basic module: W 1800 x H 1800 mm
Extension: W 1800 x H 1800 mm
Bronze colour posts



Panels Colours & Designs



Yellow Old Yellow Yellow Exposed Green Green Exposed

Column choice



Square Brown Square Black Square Antique Square Bronze

Design options



Available as single or double-sided model.

Kenninji Traditional Panels

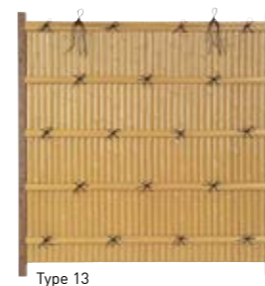

Type 13



Type 14

EVER BAMBOO® Set – Type 13
visible posts
Basic module: W 1920 x H 1800 mm
Extension: W 1860 x H 1800 mm

EVER BAMBOO® Set – Type 14
covered posts
Basic module: W 1800 x H 1800 mm
Extension: W 1800 x H 1800 mm
Bronze colour posts



Panels Colours & Designs



Brown Brown Exposed Light Brown Dark Brown

Column choice



Square Brown Square Black Square Bronze

Design options

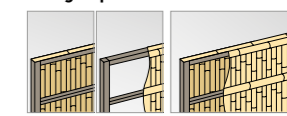

Available as single or double-sided model.

Kenninji Deluxe Panels



Type 15



Type 16

EVER BAMBOO® Set – Type 15
visible posts
Basic module: W 1920 x H 1800 mm
Extension: W 1860 x H 1800 mm

EVER BAMBOO® Set – Type 16
covered posts
Basic module: W 1800 x H 1800 mm
Extension: W 1800 x H 1800 mm
Bronze colour posts



Panels Colours & Designs



Real Yellow Real Exposed Sesame Brown Real Green

Column choice



Square Brown Square Black Square Antique Square Bronze

Design options



Available as single or double-sided model.

Ajiro Panels



Type 21



Type 22

EVER BAMBOO® Set – Type 21
visible posts
Basic module: W 1920 x H 1800 mm
Extension: W 1860 x H 1800 mm

EVER BAMBOO® Set – Type 22
covered posts
Basic module: W 1800 x H 1800 mm
Extension: W 1800 x H 1800 mm
Bronze colour posts



Panels Colours & Designs



Yellow Young Brown Dark Brown

Column choice



Square Brown Square Antique Square Yellow Square Bronze

Design options



Available as single or double-sided model.

Kyo-an Panels



Type 17



Type 18

EVER BAMBOO® Set – Type 17
visible posts
Basic module: W 1920 x H 1800 mm
Extension: W 1860 x H 1800 mm

EVER BAMBOO® Set – Type 18
covered posts
Basic module: W 1800 x H 1800 mm
Extension: W 1800 x H 1800 mm
Bronze colour posts



Panels Colours & Designs



Antique Antique Exposed

Column choice

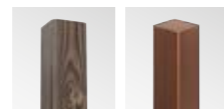

Antique 60R Square Bronze

Design options



Available as single or double-sided model.



Type 23



Type 24

EVER BAMBOO® Set – Type 23
visible posts
Basic module: W 1920 x H 1800 mm
Extension: W 1860 x H 1800 mm

EVER BAMBOO® Set – Type 24
covered posts
Basic module: W 1800 x H 1800 mm
Extension: W 1800 x H 1800 mm
Bronze colour posts



Panels Colours & Designs



Yellow Exposed Dual

Column choice



Square Brown Square Black Square Yellow Square Bronze

Design options

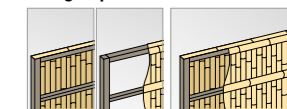

Available as single or double-sided model.

EVER BAMBOO® SET

Kyo-an Grid Panels



Type 25



Type 26

EVER BAMBOO® Set – Type 25
visible posts
Basic module: W 1920 x H 1800 mm
Extension: W 1860 x H 1800 mm

EVER BAMBOO® Set – Type 26
covered posts
Basic module: W 1800 x H 1800 mm
Extension: W 1800 x H 1800 mm
Bronze colour posts



Panels Colours & Designs



Yellow Exposed Dual Antique

Column choice



Square Brown Square Antique Square Yellow Square Bronze

Design options



Available as single or double-sided model.

Misu Deluxe Sticks



Type 5 DX



Type 6 DX

EVER BAMBOO® Set – Type 5DX
visible posts
Basic module: W 1920 x H 1800 mm
Extension: W 1860 x H 1800 mm

EVER BAMBOO® Set – Type 6DX
covered posts
Basic module: W 1800 x H 1800 mm
Extension: W 1800 x H 1800 mm
Bronze colour posts



Panels Colours & Designs

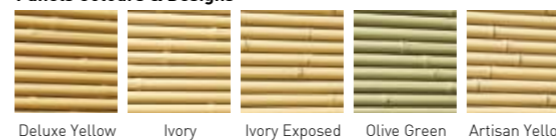

Deluxe Yellow Ivory Ivory Exposed Olive Green Artisan Yellow

Column choice

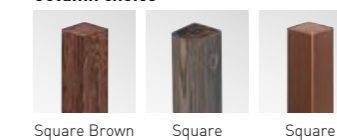

Square Brown Square Antique Square Bronze

Design options

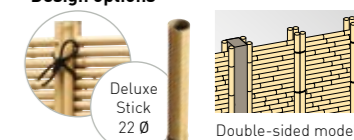

Deluxe Stick 22 Ø Double-sided model

Misu Panels



Type 3



Type 4

EVER BAMBOO® Set – Type 3
visible posts
Basic module: W 1920 x H 1800 mm
Extension: W 1860 x H 1800 mm

EVER BAMBOO® Set – Type 4
covered posts
Basic module: W 1800 x H 1800 mm
Extension: W 1800 x H 1800 mm
Bronze colour posts



Panels Colours & Designs

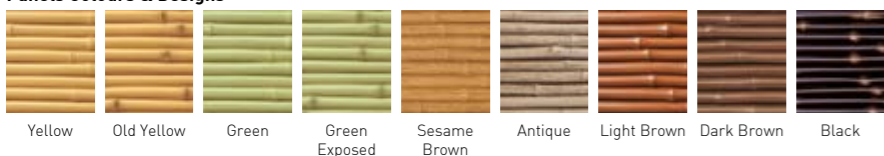

Yellow Old Yellow Green Green Exposed Sesame Brown Antique Light Brown Dark Brown Black

Column choice



Square Brown Square Black Square Antique Square Bronze

Design options

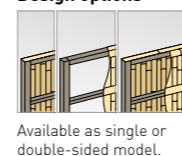

Available as single or double-sided model.

Otsu Standard Sticks



Type 19



Stick 16 Ø

EVER BAMBOO® Set – Type 19
visible posts
Basic module: W 1950 x H 1800 mm
Extension: W 1875 x H 1800 mm



Panels Colours & Designs

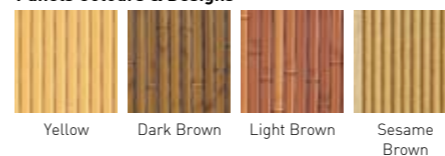

Yellow Dark Brown Light Brown Sesame Brown

Column choice

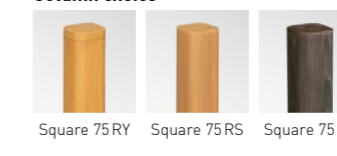

Square 75 RY Square 75 RS Square 75 RA

Design options

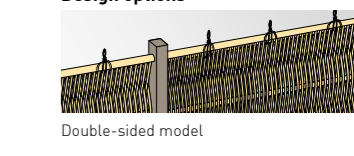

Double-sided model

Misu Standard Sticks

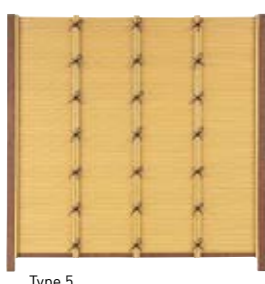

Type 5

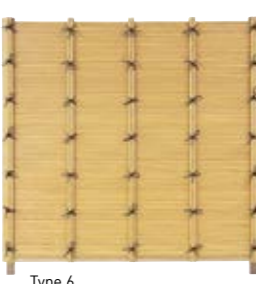

Type 6

EVER BAMBOO® Set – Type 5
visible posts
Basic module: W 1920 x H 1800 mm
Extension: W 1860 x H 1800 mm

EVER BAMBOO® Set – Type 6
covered posts
Basic module: W 1800 x H 1800 mm
Extension: W 1800 x H 1800 mm
Bronze colour posts



Panels Colours & Designs

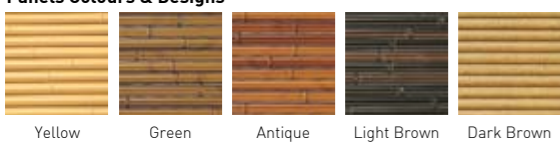

Yellow Green Antique Light Brown Dark Brown

Column choice

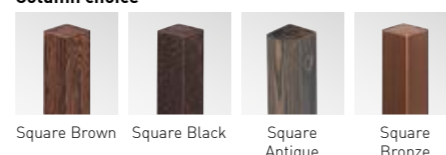

Square Brown Square Black Square Antique Square Bronze

Design options

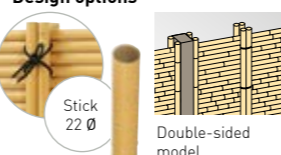

Stick 22 Ø Double-sided model

UNI BAMBOO Panels



Type 1

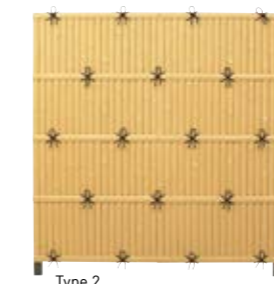

Type 2

UNI BAMBOO Set – Type 1
visible posts
Basic module: W 1920 x H 1800 mm
Extension: W 1860 x H 1800 mm

UNI BAMBOO Set – Type 2
covered posts
Basic module: W 1800 x H 1800 mm
Extension: W 1800 x H 1800 mm
Bronze colour posts



Panels Colours & Designs

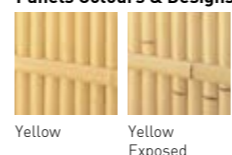

Yellow Yellow Exposed

One Touch Shuro Knots



Replica that can be installed in one step

Column choice

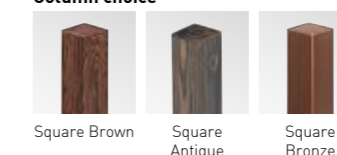

Square Brown Square Antique Square Bronze

Design options

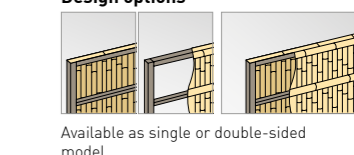

Available as single or double-sided model.

EVER BAMBOO® SET

Misugaki / Kinkakuji / Ryoanji fences



ECO BAMBOO Misugaki fence, Ivory-Exposed

Basic module: W1940 x H600/900 mm



Material: Ivory-Exposed



ECO BAMBOO Deluxe



ECO BAMBOO

ECO BAMBOO and ECO BAMBOO Deluxe are true-to-the-original reproductions of the surface texture and natural qualities of bamboo. At the same time, the materials used are environmentally friendly and long-lasting.



Yellow



Misugaki fence, Yellow

Basic module: W1940 x H600/900 mm

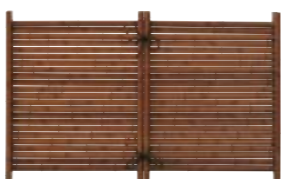

Light-Brown



Misugaki fence, Yellow, customised design

ECO BAMBOO Misugaki fence, Light-Brown

Basic module: W1940 x H600/900 mm



e-Kinkakuji fence

Basic module: W1940 x H600/900 mm



e-Ryoanji fence

Basic module: W1940 x H600/900 mm

The knots of Shuro rope show towards the front of the fence.

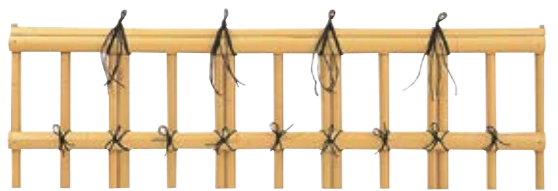

Kinkakuji fence

Basic module: W1940 x H600/900 mm



Ryoanji fence

Basic module: W1940 x H600/900 mm



Kinkakuji fence, customised design



Kinkakuji fence, Sesame Brown

Basic module: W1940 x H600/900 mm



Ryoanji fence, customised design



Ryoanji fence, Sesame Brown

Basic module: W1940 x H600/900 mm

Low fence units



EVER Lattice fence

Basic module: W1940 x H600/900 mm



e-Otsu fence

Basic module: W1940 x H600/900 mm



Yellow

Light Brown

Dark Brown

Carbon black bamboo



EVER Yamato fence

Basic module: W1940 x H600/900 mm



Shimizu fence

Basic module: W1940 x H600/900 mm



Privacy screen units

Further models available on request



GO-22 with natural dark branches

Default dimensions: W600 - 900 x H1650 mm



GO-66 Dark Brown with natural dark branches and roof

Default dimensions: W600 - 900 x H1700 mm



GO-81 Sesame Brown

Default dimensions: W600 - 900 x H1700 mm



GO-12 with bamboo sheathing

Default dimensions: W600 - 900 x H1700 mm

TAKE GAKI PRODUCT SERIES



TAKE GAKI

Traditional techniques and craftsmanship create individual products of unique beauty from natural bamboo.



The fusion of carefully selected natural materials and traditional craftsmanship produces products of unique beauty in premium quality.



The noble surface with its special expressiveness is created piece by piece in meticulous manual work by our craftsmen in Japan.



Already single modules are perfectly suitable as accents in the landscape of your garden. All TAKE GAKI products can be ordered from just one unit, while configurations according to your wishes are always possible.

Material and colours

Colour variance and deviations may occur



Modular system

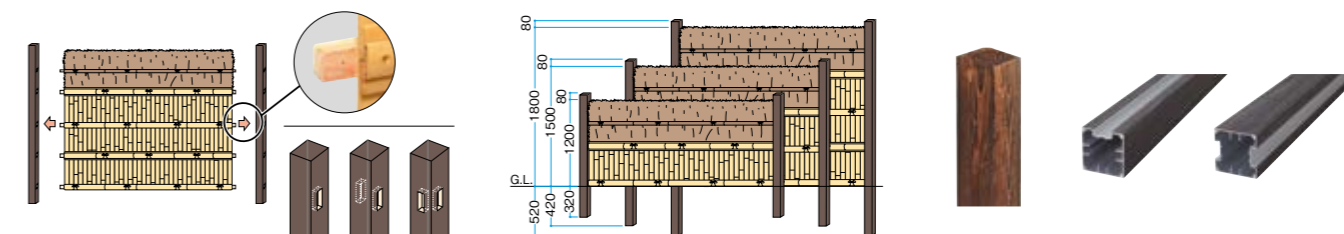

Modular construction for easy assembly

The panels, which are prefabricated by hand, can be simply attached to the end, connecting or corner posts required in each case.

Available in 3 standard heights

With the three available versions in 1200, 1500 and 1800 mm, the fence can be optimally adapted to the surroundings.

Posts made of natural wood or aluminium

The material should be chosen to complement the atmosphere of the property and the surroundings.

Kenninji Natural Bamboo Panels



Kenninji Panels

Kenninji

Default dimensions: W 1800 mm x H 1200 - 1800 mm

Available as single or double-sided model.

The single-sided version is available with or without rear cladding.

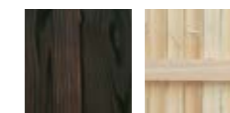

Kenninji panel with light twigs

Dark twigs

Light twigs

Single-sided models are provided with the standard rear cladding.



Misu Natural Bamboo Panels



Misu Simon Bamboo

Default dimensions: W 1800 mm x H 1200 - 1800 mm

Only available as double-sided version.



Misu Dark Bamboo

Default dimensions: W 1800 mm x H 1200 - 1800 mm

Only available as double-sided version.

TAKEGAKI PRODUCT SERIES

Roofs, garden gates and doors for fences

Available regular sizes on request



The fence canopy is attached via a connection with an L-shaped angle.

Kenninji-Garden door
SNG - 2: W700 x H1500 mm

Kuroho-Garden door
SNG - 1: W700 x H1500 mm

Well-balanced combination of modern cylinder locks with a traditional construction.

Copper post covers

The Antibacterial effect of copper protects the natural wood from rotting.



SN-CK9
W90 x D90 x H45 mm

SN-1K9
W90 x D90 x H300 mm

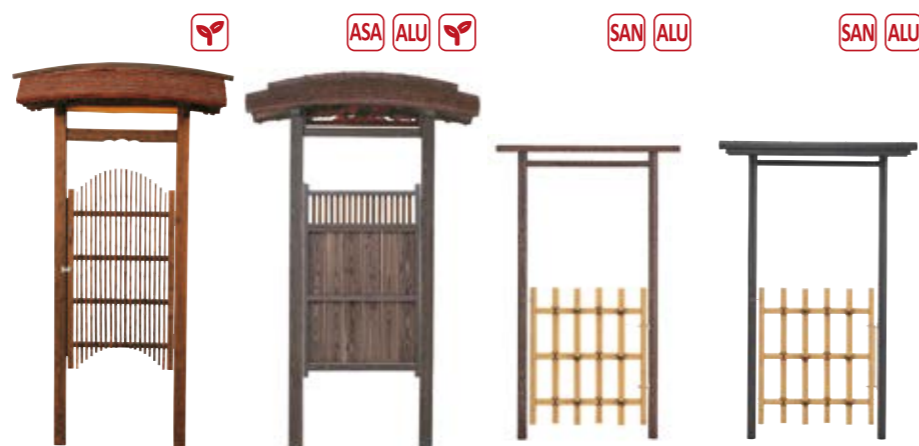

Funagata-Gates

KYH - 05, Natural material: approx.
W1515 x H2603 mm

HNM - 02, with aluminium posts: approx.
W1550 x H2610 mm

Torii-Gates

TRM - 01, with aluminium frame: W920 x H2342 mm

TRM - 02, with aluminium frame: W920 x H2370 mm

Dimensions may vary slightly



HGM - 03, double-winged:
W2130 x D700 x H2600 mm

HGM - 05, single-winged:
W1750 x D700 x H2600 mm

HGM - 01, without wings:
W1370 x D700 x H2600 mm

HGM - 01N, Gate frame:
W1370 x D700 x H2600 mm

Double-wing Fugamon gate

Fuga-Gate

Available in three designs: without wings, single-winged and double-winged. Alternatively, Fuga gates are also available in our UV-resistant and weatherproof EVER BAMBOO® material.

Privacy screen units

Available sizes on request

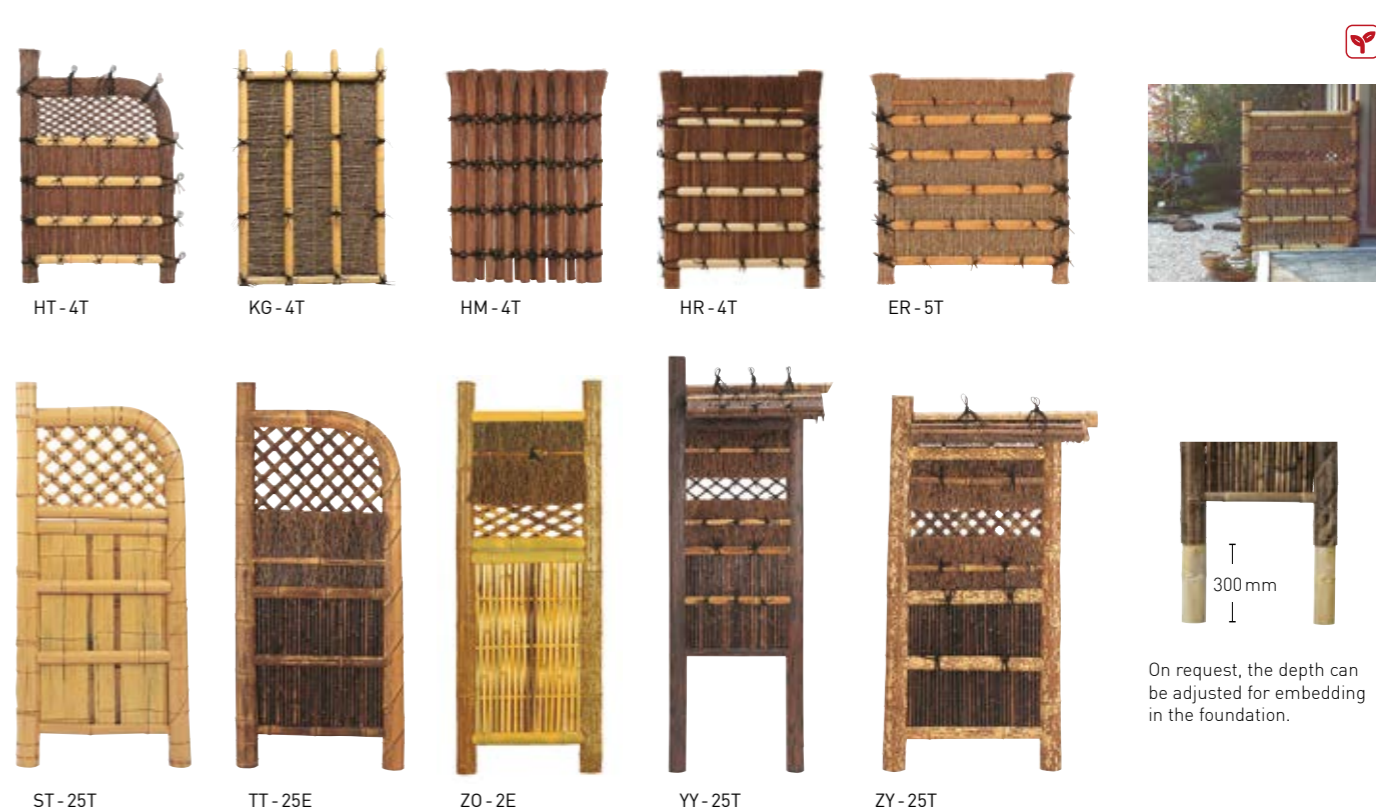

On request, the depth can be adjusted for embedding in the foundation.

Natural & Aluminium Hybrid Fence Fence modules for space division



Default dimensions for low models: W900 x H1200 mm

Default dimensions for high models: W600 - 1200 mm x H2200 mm

Individual dimensions are also possible on request.

Default dimensions: W600 - 1200 mm x H1700 mm
Individual dimensions are also possible on request.

Posts and frames are made of very durable and weather-resistant aluminium with a natural bamboo texture.

There are numerous grains and colours to choose from for the textures.



TAKE GAKI PRODUCT SERIES

Natural Koetsuji fence



Exact dimensions on request.

Natural Kuzuryu fence

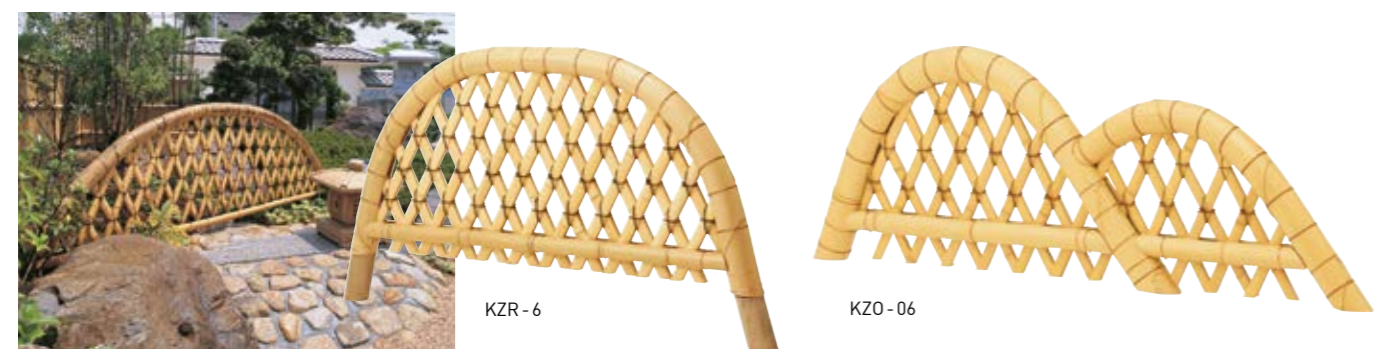

Natural Kuzuryu-fence

Default dimensions: W 1800 - 3000 x H 800 - 1300 mm
Exact dimensions and individual sizes available on request.

Kuzuryu-fence (parent and child type) with embedding

Default dimensions: W 1800 - 3000 x H 600 - 1000 mm
Exact dimensions and individual sizes available on request.

Bamboo & Wood Garden Doors



Bamboo branch garden doors

Default dimensions: W 600 - 750 x H 1050 mm
Exact dimensions and individual sizes available on request.

Bamboo and wood garden doors

Default dimensions: W 600 - 750 x H 900 - 1300 mm
Exact dimensions and individual sizes available on request.

Low garden fences

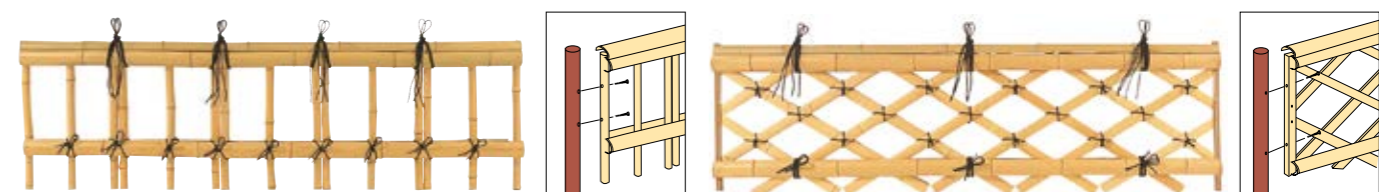

Natural Kinkakuji fence

Default dimensions: W 1800 x H 600/900 mm



Natural Ryoanji fence

Default dimensions: W 1800 x H 600/900 mm

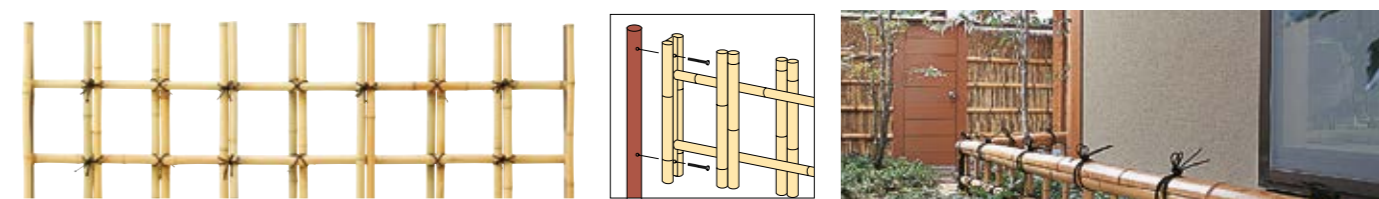

Natural Yotsume fence

Default dimensions: W 1800 x H 600/900 mm

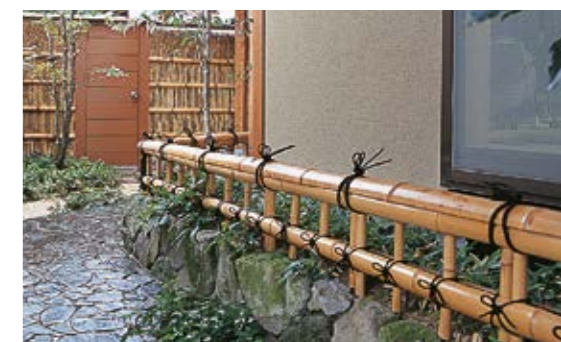

Room dividers

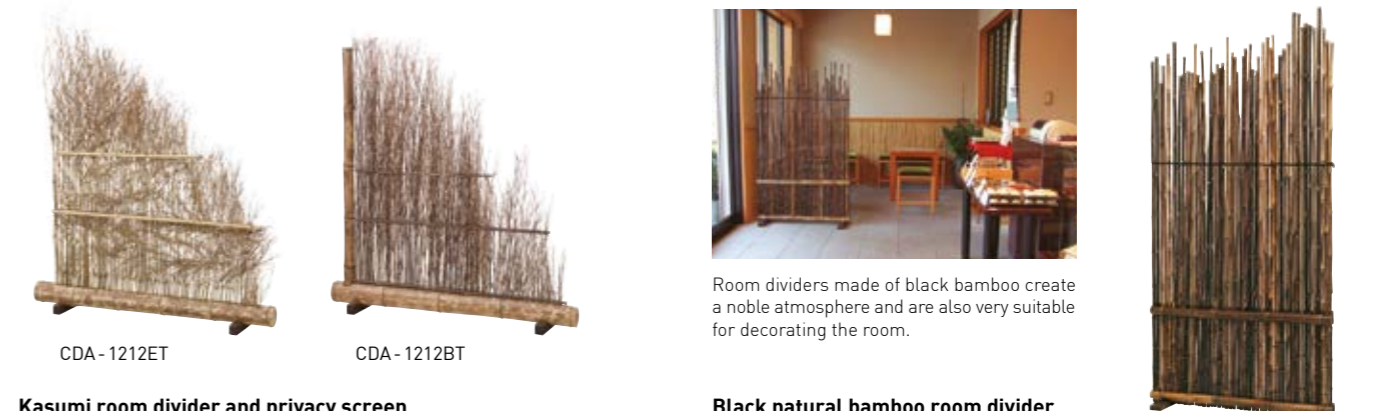

Kasumi room divider and privacy screen

Default dimensions: W 1200 x H 1200 x D 200 mm
Individual dimensions available on request.

Black natural bamboo room divider

Default dimensions: W 900 x H 1500 x D 300 mm
Individual dimensions available on request.



ECO BAMBOO realistically reproduces the structures of natural bamboo, making it ideal for interior design in the modern Japanese style.



ECO BAMBOO room divider

Default dimensions: W 900 x H 1500 x D 300 mm
Individual dimensions available on request.



WUT-30

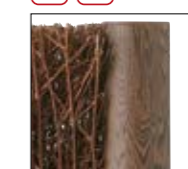

The combination of aluminium with natural products ensures durability and gives a natural impression.

Room divider made of natural bamboo twigs with aluminium frame

Default dimensions: W 900 x H 1200 x D 250 mm
Individual dimensions available on request.



WUT-31

SUKIYA MON PRODUCT SERIES



SUKIYA MON

Majestic beauty created by the finest materials and craftsmanship



Roof

Refined with copper or coloured steel sheet. Brick tops provide an elegant look.

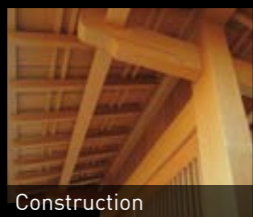

Construction

Materials of the highest quality and the design with invisible fittings give the gates their authentic character.

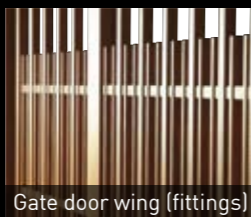

Gate door wing (fittings)

The fine latticework in particular reflects the sophisticated technique and beauty of traditional Japanese architecture.



Thresholds and pillars

Polished natural granite convey a feeling of high value and give the door a prestigious impression.

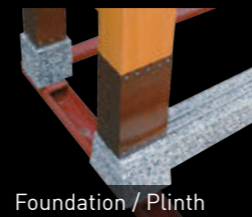

Foundation / Plinth

The height adjustment facility integrated into the foundation ensures easy installation and alignment of the base.



Sukiya Gate Type 1 Basic Version



Fabricated on client's request

To this day, the sukiya-zukuri are made from carefully selected natural wood using traditional techniques. With balanced shapes and proven methods, impressive structures are created by master craftsmen in the style of classical Japanese architecture.

The front is made in a special way so that large bolts and connecting fittings are not visible. This elaborate construction makes each gate a gem of form, function and durability.

Only red cedar wood of exquisite quality without knotholes is used for the construction of the pillars, gate wings and frames, which ensures that the material will not crack or twist. This provides each gate with a structure that is resistant to the influences of the weather.

Customised manufacturing based on your wishes



SKY-1BK-DM

Sukiya Gate, Type 1 with 2 wings

Wood: Japanese red cedar | Roof: copper sheet and tiles
Gate door wings: Kiriko bars with lattice | Pedestal: natural granite



SKY-1BK-D

Sukiya Gate Type 1 with 1 wing

Wood: Japanese red cedar
Pedestal: natural granite
Roof: copper sheet and tiles
Gate door wings: Kiriko rods with lattice



SKY-1BK-D

Sukiya Gate Type 2

Roof & ridge: coloured copper plate
Gate door wings: Senbon lattice with ribbon



Sukiya Gate Type 2

Each Sukiya gate is unique in its own way and is crafted with care and skill by the hands of a master craftsman. In the process the conditions of the location and individual wishes are taken into account. So you can choose the size, the design of the roof, the type of gate wings as well as the colour of the wood for your specimen, according to your imagination.

Dimensions and styles

Door wing options

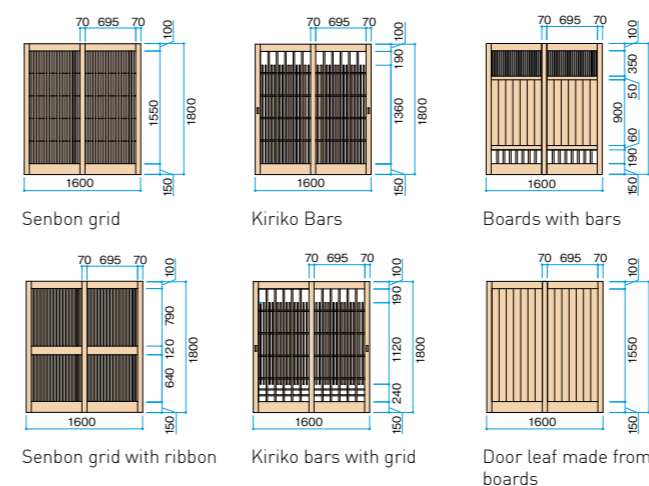

Options for roofs

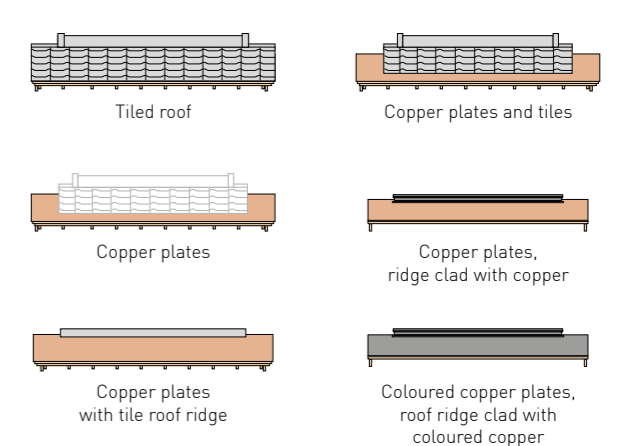

Colours

There is a choice of two colour tones for the material.

As a standard colour, red cedar brings out the original character of the wood best.

The traditional Mingei colour has a dark wood tone with a calm aura.



Default: Red cedar



Traditional: Mingei



EVER BAMBOO® DECORATION

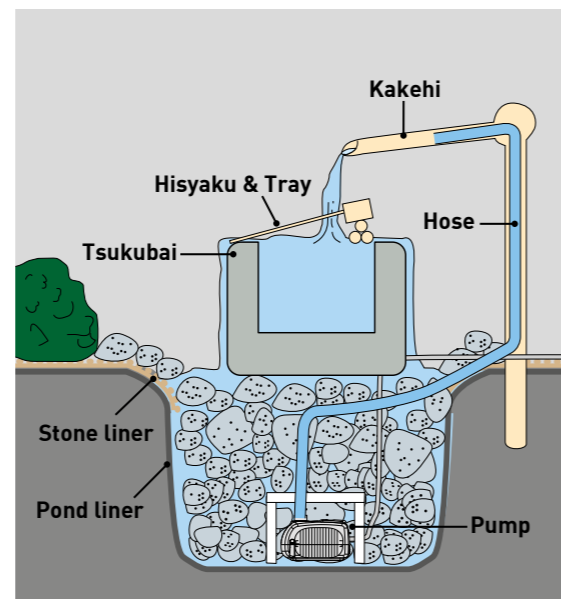
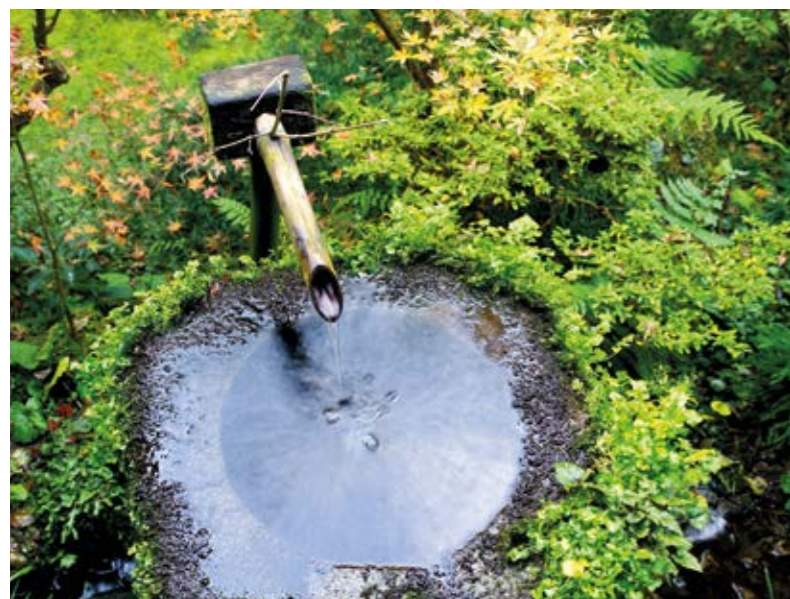

Kakehi

Just like all EVER BAMBOO® products, our Kakehi made of SAN resin are particularly durable and resistant to weathering or discolouration.

Code: KK-1
Size in mm: H 750 / H 900
Material: SAN, urethane foam

Code: KK-2
Size in mm: H 750 / H 900
Material: SAN, urethane foam

Code: KK-4
Size in mm: H 750 / H 900
Material: SAN, wood (hemlock)

Code: KK-10
Size in mm: H 540
Material: SAN, wood (hemlock)

Code: CGA-K3
Size in mm: H 1000
Material: natural bamboo

Code: BK-1
Size in mm: H 1000
Material: natural bamboo, cedar wood

Code: BK-1L
Size in mm: H 900 x W 1800
Material: natural bamboo, cedar wood

Shishiodoshi

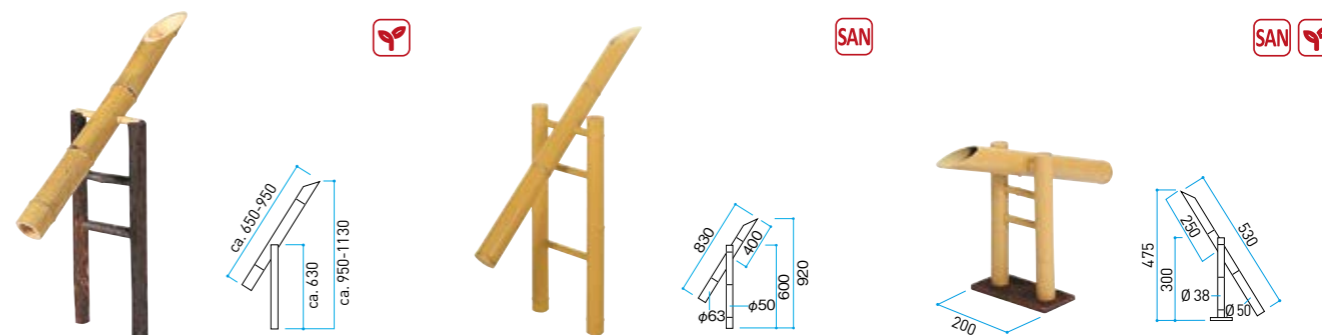

Code	Size in mm	Code	Size in mm	Code	Size in mm
BS-1	W 300 x H 630	ES-11	W 270 x H 600	ES-12	W 200 x H 475
Material: Bamboo, Hinoki (Japanese cypress)		Material: SAN		Material: SAN, wood	

Hisyaku

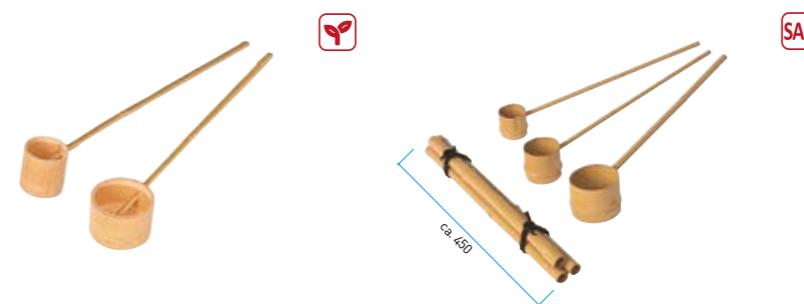

Code	Size in mm	Code	Size in mm
TH-15	L 460, Ø 60	EH-23	L 430, H 40 x Ø 50
TH-16	L 470, Ø 80	EH-22	L 440, H 45 x Ø 60
Material: natural bamboo		EH-21	L 460, H 40 x Ø 80
		EH-25	L 450
Material: SAN			



Benches



Code	Size in mm	Code	Size in mm	Code	Size in mm	Code	Size in mm
HE-02	W 1500 x H 430 x D 440	YE-150	W 1470 x H 400 x D 450	FB-4	W 1200 x H 450 x D 350	B-9	W 1200 x H 350 x D 400
Material: aluminium		Material: aluminium		Material: SAN		Material: natural bamboo	

EVER BAMBOO® DECORATION

FRP Stones & Rocks (replicas made of fibre-reinforced plastic)



Landscape stones

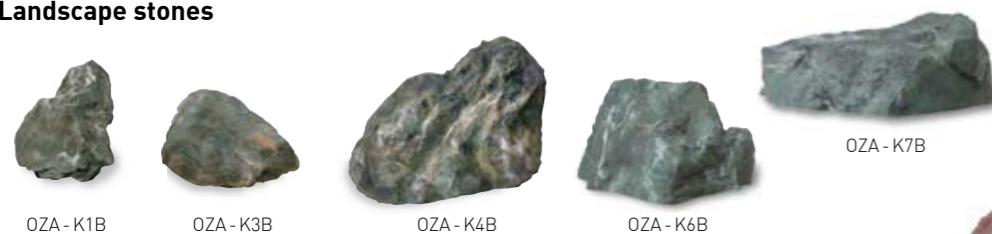

The FRP stones are particularly well suited for interiors or for green roofs, where low weight is important. Of course, they are also particularly resistant to weathering.

Code	Size (mm)	Weight (kg)
OZA-K1B	approx. W350×D300×H200	2,5
OZA-K3B	approx. W380×D320×H150	1,5
OZA-K4B	approx. W600×D400×H430	4,2
OZA-K6B	approx. W570×D450×H320	2,5
OZA-K7B	approx. W760×D510×H250	3,4
OZA-K11B	approx. W900×D800×H450	7,1

Further shapes and sizes on request



Stepping stones



Code	Size (mm)	Weight (kg)
OZA-B1R	approx. Ø350×H100	1,4
OZA-B3R	approx. Ø550×H150	4,0
OZA-B4B	approx. W450×D400×H100	2,5

Further shapes and sizes on request

Rocks



Code	Size (mm)	Weight (kg)
OZA-T1B	approx. W500×D280×H500	3,0
OZA-T3B	approx. W650×D600×H700	6,5
OZA-T4B	approx. W600×D370×H820	8,4
OZA-T7R	approx. W900×D450×H900	12,0

Further shapes and sizes on request

Shigeraki pots with lighting



The combination of light and softly rippling water supports a pleasant and friendly environment.



Code	Size (mm)	Weight (kg)
TEH-40	Ø 370 × H 175	6,0
TEH-50	Ø 475 × H 215	10,0

Accessories: lamp (10W), 1 submersible pump, number of required sockets: 1



Code	Size (mm)	Weight (kg)
TSK-13	Ø 285 × H 385	6,0
TSK-15	Ø 390 × H 510	12,0
TSK-20	Ø 470 × H 620	22,0

Accessories: lamp (10W), 1 submersible pump, number of required sockets: 1

Shigeraki water bowls



Code	Size (mm)	Weight (kg)
WK-MB90	Ø900×H165	31
WK-MB70	Ø700×H170	18
WK-MB60	Ø600×H140	12
WK-19S	Ø410×H160	5,4
WK-16S	Ø460×H190	5,7

Material: Shigeraki ceramic



Shigeraki Tsukubai sets (Kakehi/Hisyaku/Tsukubai)



Code	Size (mm)	Weight (kg)
TSU-13	Ø 400 × H 130 [Dimension of the ceramic bowl]	9,5
TSU-10	Ø 310 × H 130 [Dimension of the ceramic bowl]	6,2
TSU-8	Ø 250 × H 120 [Dimension of the ceramic bowl]	4,2

Material: Kakehi - SAN / Hisyaku - SAN / Tsukubai - Shigeraki ceramics



The gentle lapping of the water supports a pleasant, relaxed atmosphere.

Stone Tsukubai Japanese garden lanterns



Code	Size (mm)	Weight (kg)
OZA-C1	approx. W300×D270×H150	1,4 / 0,4
OZA-C2	approx. W450×D350×H330	3,5
OZA-R4	approx. W500×D500×H430	4,8
OZA-R2	approx. W600×D600×H600	7,4
OZA-R3	approx. W450×D450×H700	4,8
OZA-R1	approx. W460×D460×H1250	9,0

Material: FRP

OZA-R1

EVER ART WOOD® MATERIAL



EVER ART WOOD®

Create an atmosphere where you feel comfortable and want to spend time. Perfectly balanced concepts and elegant solutions for home and garden with the EVER series products.

Aluminium Bamboo



Connecting pieces

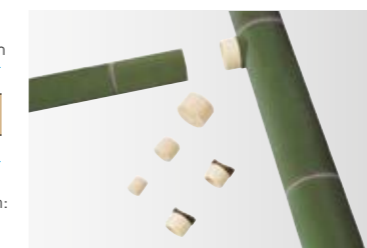
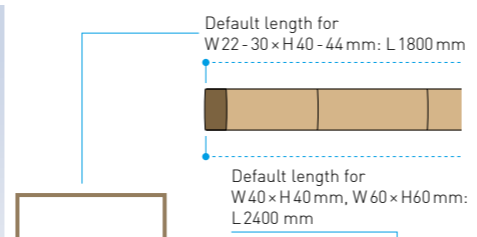
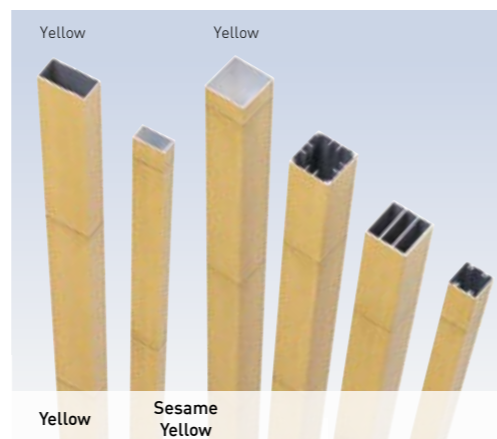
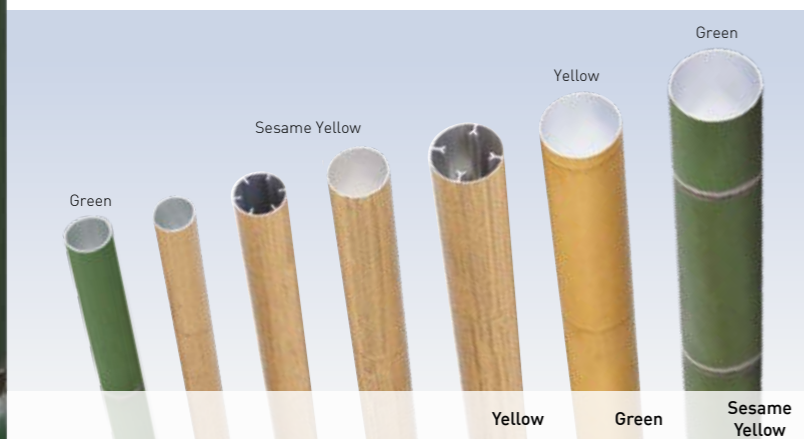

Round column connector
Column Ø 60 mm → Brace Ø 40/60 mm



Square column connector
Square column → Brace 20 x 40 mm
Square column → Brace 30 x 60 mm
Square column → Brace 60 x 60 mm



Connector ECO BAMBOO
Column Ø 60 mm → Brace Ø 22-50 mm

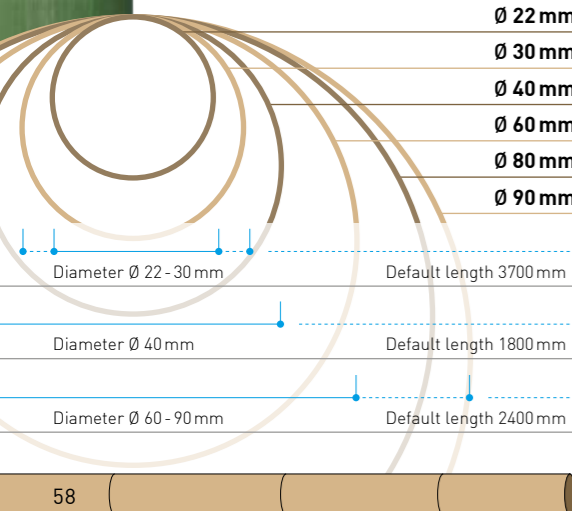

	Yellow	Green	Sesame Yellow
Ø 22 mm	•	•	•
Ø 30 mm	•	•	•
Ø 40 mm	•	•	•
Ø 60 mm	•	•	•
Ø 80 mm	•	•	•
Ø 90 mm	•	•	•

Diameter	Default length	AMM - ..Ø"1	AMW - ..Ø"2	AMG - ..Ø"3
Diameter Ø 22-30 mm	Default length 3700 mm			
Diameter Ø 40 mm	Default length 1800 mm	AMN - 408	AMW - 408	AMG - 408
Diameter Ø 60-90 mm	Default length 2400 mm	AMN - ..Ø"8	AMW - ..Ø"8	AMG - ..Ø"8

	Yellow	Sesame Yellow	
20 x 40 mm	•	•	ATD - 204
22 x 40 mm	•	•	ATD - 224
22 x 44 mm	•	•	RMD - 244
			RGD - 244
26 x 40 mm	•	•	ATD - 260
30 x 60 mm	•	•	ATD - 306

40 x 40 mm	•	•	AMH - 408*
			AGH - 408*
60 x 60 mm	•	•	ATH - 608
			MHT - 608**
			HMR - 608***

* incl. Screw holes
** with guide rails
*** three-chamber reinforcement

End cap

Matching end caps are available for all profile sizes, décors and colours.



True to original, material: ABS

Bamboo leaves

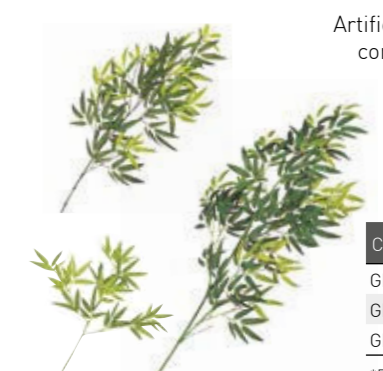

Artificial bamboo leaves complete the realistic atmosphere of a bamboo forest.

Code	Size in mm
GN - 14 G	L 800
GN - 08 G	L 1200
GN 11	L 400

*For indoor use only

EVER ART BOARD® MATERIAL



EVER ART BOARD®

Create an atmosphere where you feel comfortable and want to spend time. Perfectly balanced concepts and elegant solutions for home and garden with the EVER series products.

Aluminium composite panels with Japanese textures

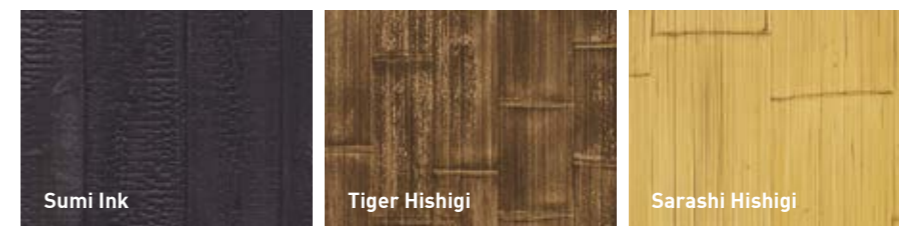
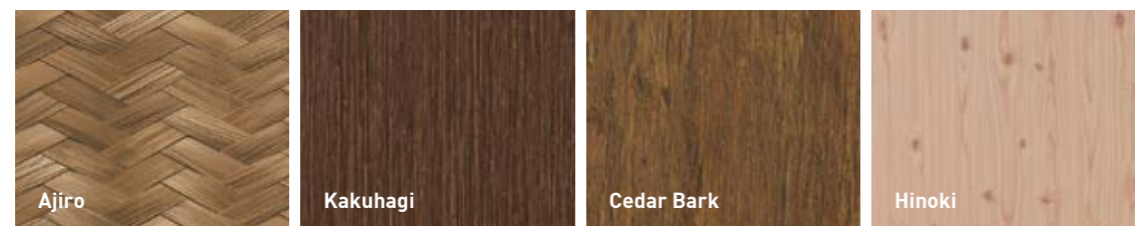

Our EVER ART BOARD® is made with a high quality laminate that ensures high weather resistance to rain and sun, preventing corrosion or fading of colours. The easy handling during processing and assembly make the aluminium composite panels the ideal material for flexible and individual projects indoors and outdoors.

Natural touch surface (embossing texture)

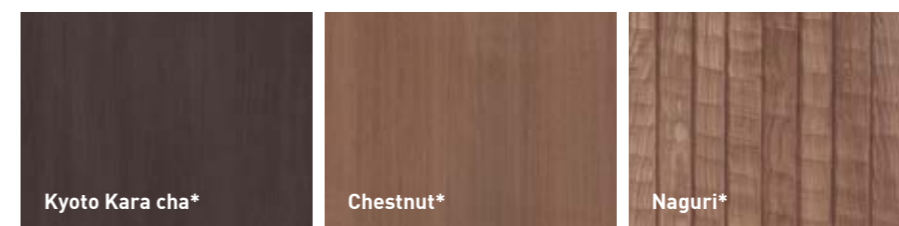
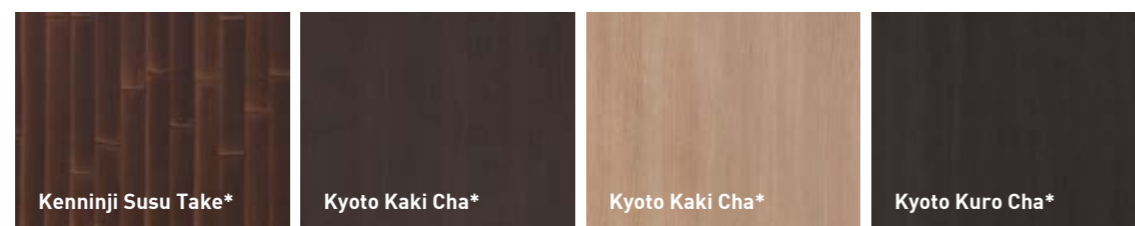

*With their detailed surface texture, the décors of the product series with natural touch coating are particularly close to nature.

Default Dimensions

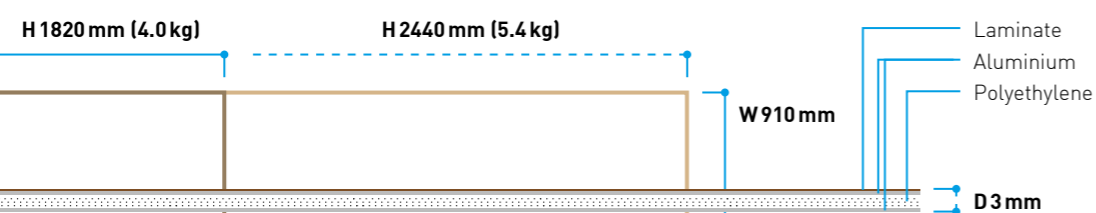

End cover strip 22 × 15 × 3650 mm



Centre cover strip 22 × 15 × 3650 mm

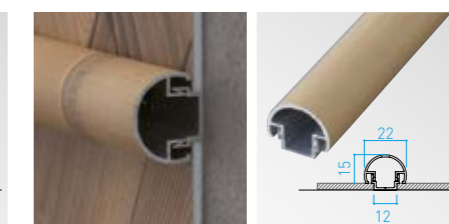

Available profile types



An overview of all profile types and décors can be found in the EVER ART BOARD® product catalogue.

PHOTOREALISTIC LAMINATED ALUMINIUM PROFILES

Nature-like décors replicate wood surfaces true to the original and offer numerous design options for elegant projects in and around the building.

JAPANESE LIGHTING

Materials and designs that harmonize with nature and soft light create a comfortable rhythm in the darkness, by creating a taste of the oriental garden.

EVER ART WOOD®

Examples of modular systems with aluminium frames and panels

Otsu fence Seimizu fence Narrow grid Yamato fence

Default dimensions: H 2000 / 2400 mm Default dimensions: H 2000 / 2400 mm

ALU ASA SAN ABS ALU

Grid fence elements - examples from the Kyoto series

Narrow Grid Masu Grid Oboro Grid Itoya Grid Kasumi Grid

Colours: Kyoto Kara Cha, Kyoto Kare Iro, Kyoto Kuro Cha, Kyoto Kaki Cha

Default dimensions: W 900 x D 30 x H 1800 mm, W 1800 x D 30 x H 1800 mm, W 900 x D 68 x H 1800 mm

ALU

*Further models and colours in the EVER ART WOOD catalogue or on request

LEDIUS EXTRA-LOW VOLTAGE LIGHTING

MODERN*

•12V •24V

HONO-AKARI ATMOSPHERIC LIGHTS (2000 K)

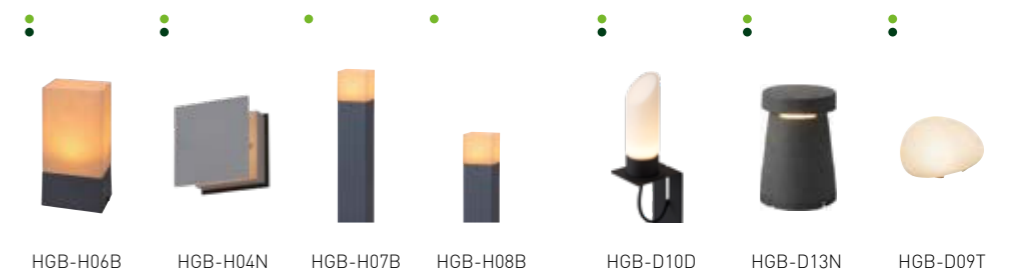

Dimensions: W 70 - 133 x D 70 - 92 x H 140 - 600 mm
Luminosity: 91 - 165lm
Watts: 2,5W
Colour temperature: 2000 K

Dimensions: W 100 - 205 x D 120 - 191 x H 120 - 495 mm
Luminosity: 70 - 120lm
Watts: 1,2 - 4,0W
Colour temperature: 2700 - 3000 K

TRADITIONAL*

•12V •24V

FLICKERING LANTERN LIGHT



Dimensions: W 135 - 296 x D 130 - 296 x H 720 mm
Luminosity: 91 - 165lm
Watts: 1,2 - 1,8W
Colour temperature: 3200 K

NATURAL CANDLELIGHT

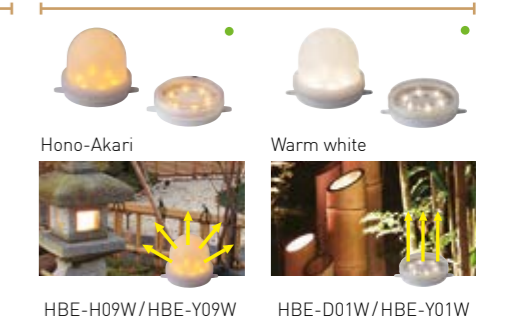

Dimensions: B 103 x T 85 x H 80 mm
Luminosity: 108 - 120lm
Watts: 1,2 - 1,8W
Colour temperature: 2000 K

Dimensions: B 103 x T 85 x H 80 mm
Luminosity: 58 - 90lm
Watts: 1,2 - 1,3W
Colour temperature: 3200 K

*Further models in the LEDIUS catalogue or on request



Takasho Co.,Ltd.

20-1, Minami-akasaka, Kainan, Wakayama, 642-0017, Japan
phone: +81-(0)73-486-2533
fax: +81-(0)73-486-2563
e-mail: takasho-global@takasho.co.jp
web: https://takasho.co.jp



Takasho Co., Ltd. Zweigniederlassung EU

Sulzbacher Str. 199, 71522 Backnang, Germany
Tel: +49 (0)7191-96933-0
Fax: +49 (0)7191-96933-20
E-Mail: contact@takasho.eu
Web: https://takasho.eu
https://alu-artport.de



Takasho Garden Living India Pte. Ltd.

E-17, Siddhi Vinayak Towers, Behind DCP Office, Off. S. G.
Highway, Makarba, Ahmedabad 380 051 Gujarat, India
phone: +91-79-4898-251
e-mail: customerservice@takasho.in
web: https://takasho.in



Takasho Vietnam Office

The 4C floor of 86 Xuan Thuy St. Thao Dien Ward,
District 2, HCMC, Vietnam
phone: +84-(0)8-6656-1648
fax: +84-(0)8-6656-1648



Takasho Shanghai Office

Flat 25G, No379, Pudong(S) Rd., Shanghai China, 200120
phone: +86-21-3383-1280
fax: +86-21-3383-1279



VegTrug Limited

2B Wyncolls Road
Colchester Business Park
Colchester, Essex, CO4 9HU, United Kingdom
phone: +44-1206-230025
web: https://www.vegtrug.com



Takasho Australasia Pty. Ltd.

32, Mickle Street Dandenong South Victoria 3175, Australia
phone: +61-3-9706-4438
fax: +61-3-9706-4439
e-mail: ahogg@takasho.com.au
web: https://takasho.com.au



Takasho Korea Branch Office

19-66 Kyodonggil, Yangseung-myeon Anseong-si, Gyeonggi-do, Korea
phone: +82-31-674-6150
fax: +82-31-674-6152
e-mail: takasho-global@takasho.co.jp
web: http://takasho.co.kr



Hongkong Takasho Holdings Co., Ltd.

8/F., Richmond Comm. Bldg. 109 Argyle St., Mong Kok,
Kowloon, Hong Kong
phone: +86 792-481-5673



Jiangxi Takasho Import-Export Trade Co.,Ltd.

Jiujiang Takasho Gardening Product Co.,Ltd.

South Garden, Gold Industry Garden, Ruichang City,
Jiangxi Province, China, 332200
phone: +86-(0)792-4815788
fax: +86-(0)792-4815675



VegTrug USA Inc.

208 Progress Drive
Montgomeryville
PA 18936 United States of America
phone: +1-(888)-908-2008