



# CONDAIR HP

In-duct high-pressure  
spray humidifier



# Low energy humidification and evaporative cooling

## Water pump and RO treatment station

Removes minerals from the supply water and pressurises it directly to the nozzle grid.

## Control panel

The user interface panel, controlled by a Siemens Programmable Logic Controller (PLC), has a clear and easy to use touch screen.

## Integrated RO system

An optional reverse osmosis system to remove minerals from the supply water, ensuring dust-free, hygienic humidification.

## Energy-efficient RO pump

A high-quality Grundfos electric motor provides low power consumption and reliable operation.

## Stainless steel high-pressure pump

A high-pressure, water lubricated, oil-free pump provides water at around 70bar.

## Stage valve block

The valve block provides up to 15 stages of output for +/-4%RH control.

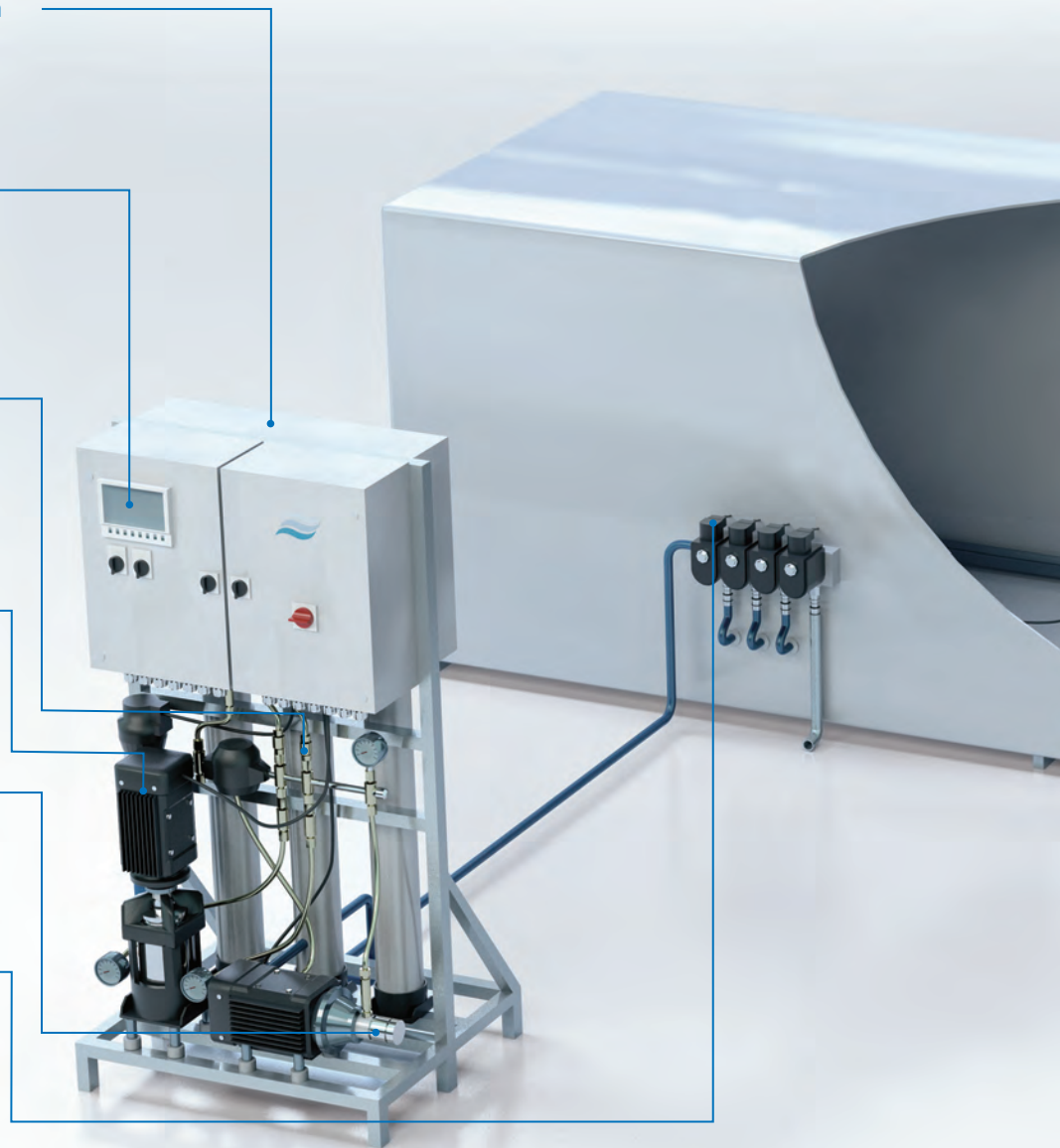

# CONDAIR HP

In-duct high-pressure spray humidifier

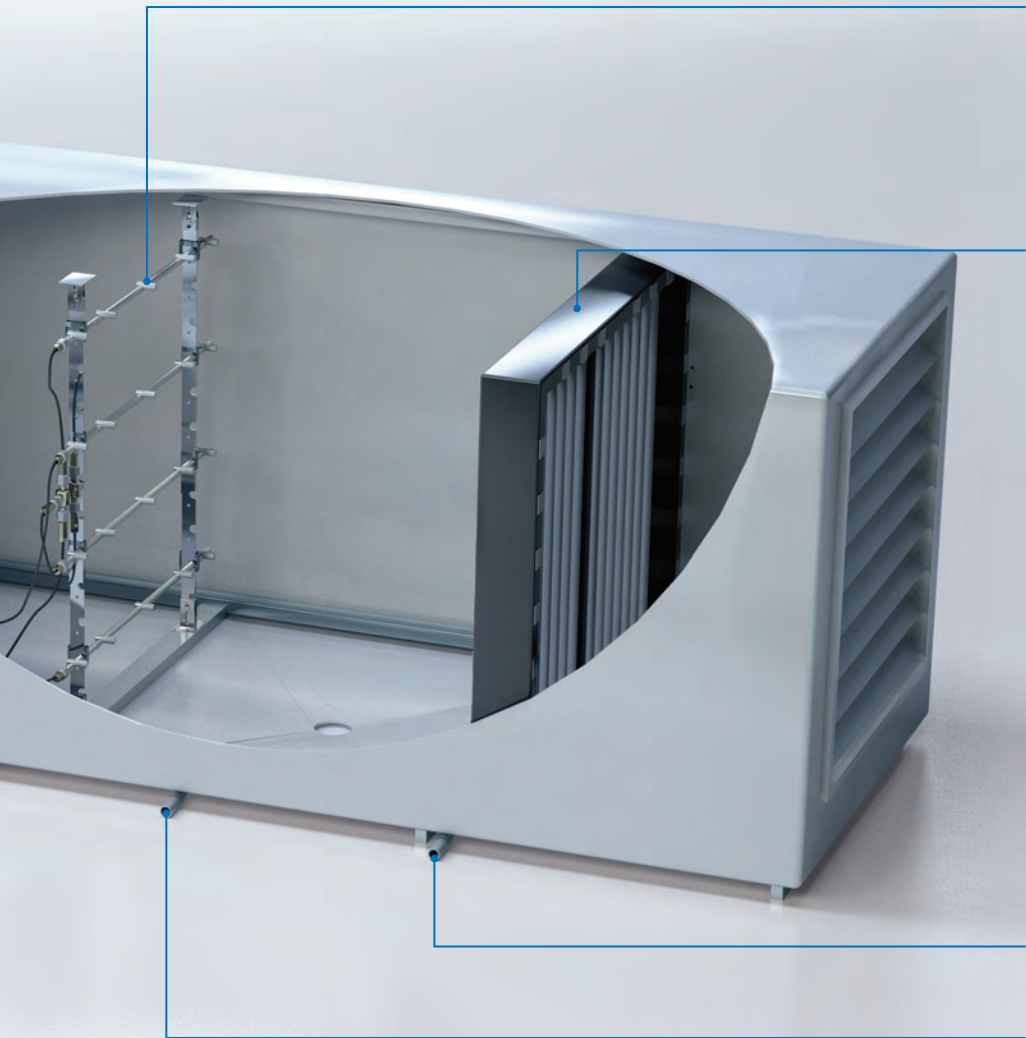

**Spray nozzle grid**

Precision manufactured high-quality, stainless steel nozzles atomise water into a fine mist, evenly spread across the duct to provide uniform humidification.



**Droplet separator**

Removes unevaporated water droplets from the air stream.

**Droplet separator drain**

**Humidification section drain**

The Condair HP is a high-pressure, low energy, in-duct spray humidifier delivering adiabatic humidification and cooling to air handling units (AHU) and ducts.

A single high-pressure pump station is capable of supplying spray nozzles in multiple AHUs with up to 1,300kg/hr of humidity.

As well as a large humidification capacity the system can provide up to

884kW of adiabatic cooling from just 2.2kW of consumed electricity.

A control accuracy of  $\pm 4\%RH$  is achievable with up to 15 stages of output across the nozzle grid, making the Condair HP suitable for a wide range of applications.

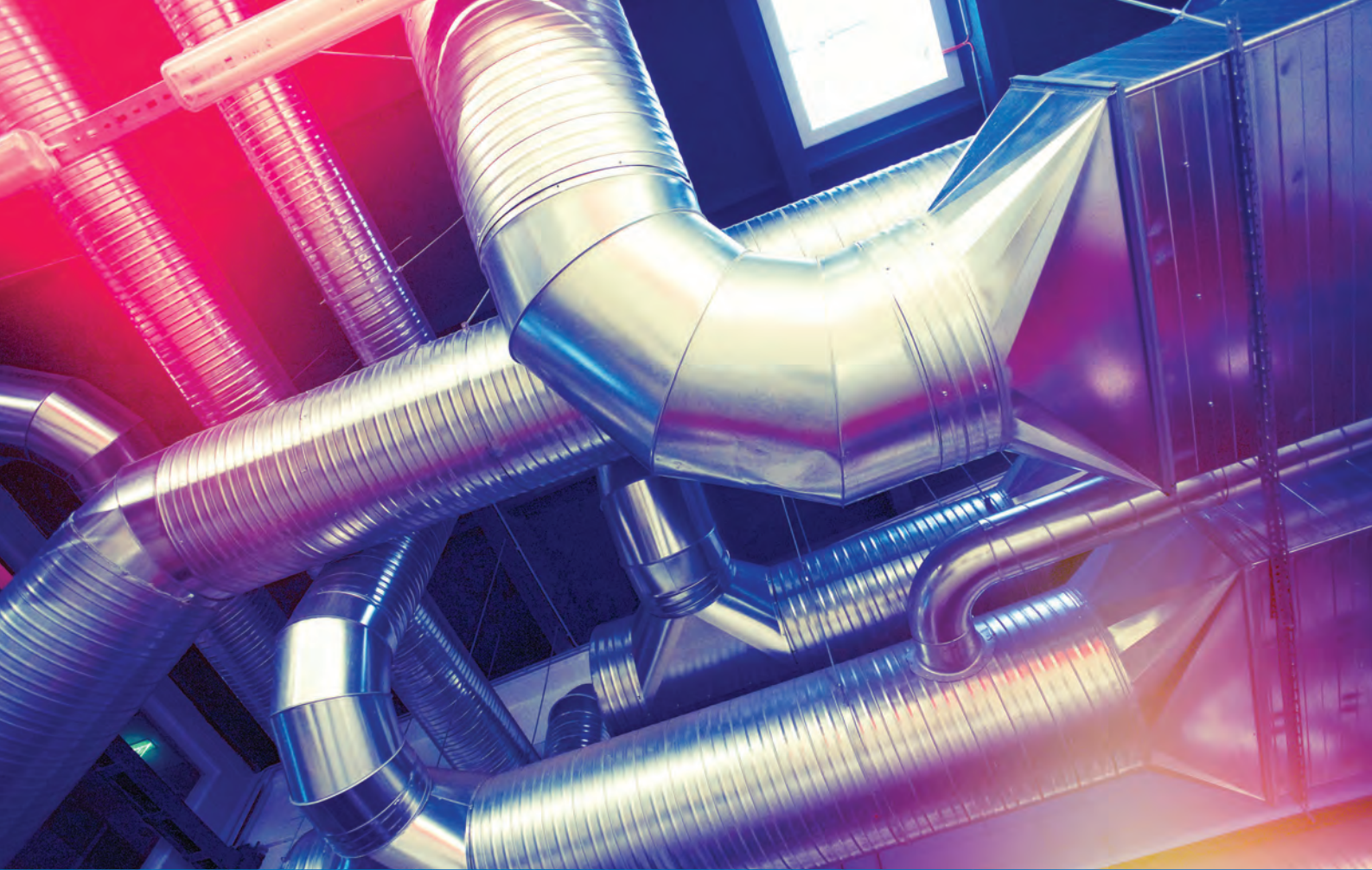

Humidify up to four AHUs from one pump station with up to 1,300kg/h of moisture

## One humidifier, multiple AHUs

The Condair HP can offer humidity control to multiple AHUs or ducts, from a single high-pressure pump station, with local regulation to each nozzle grid.

### Flexible capacities

This master/slave configuration can be used in a wide range of applications

where up to 1,300kg/hr of humidification is required.

The master control unit is built into the pump station and consists of an easy to operate Siemens PLC, which regulates the stage valves and adjusts outputs to the required levels.

### Separate control

With multiple zones, each slave is equipped with a separate controller, although all the operating parameters can be viewed or edited from the master control.

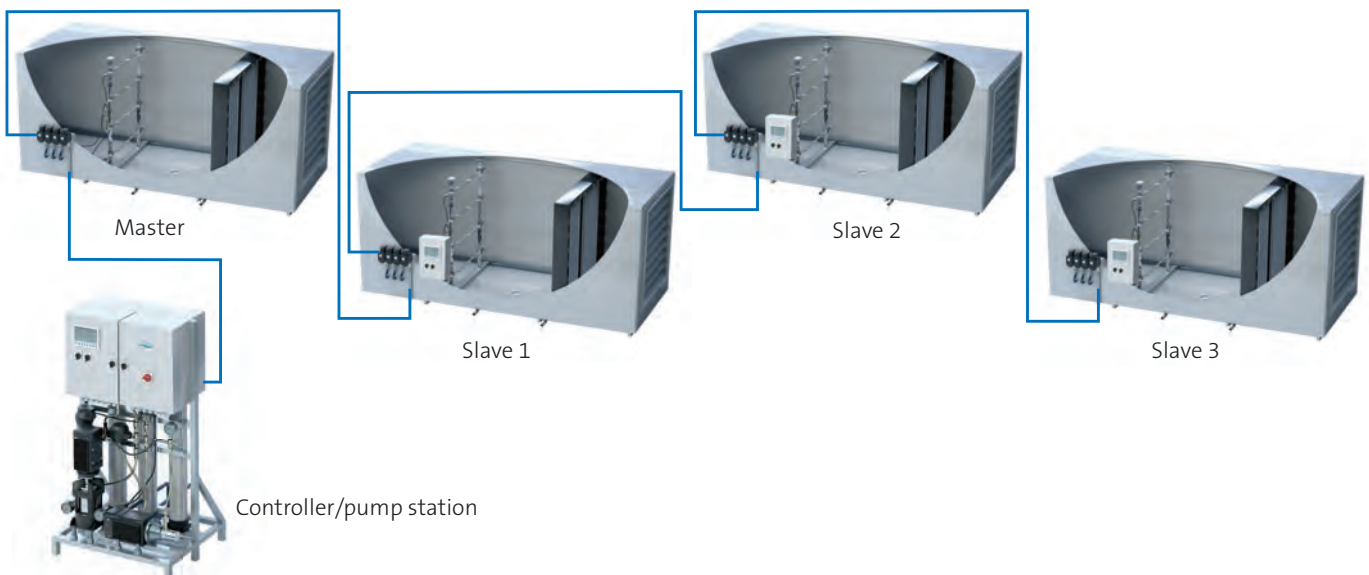



Precision manufactured, impeller type high pressure nozzles generate an extremely fine spray

## Premium quality components

The Condair HP is manufactured in high-quality materials to provide long lasting and reliable operation.

### **Uniform distribution**

An innovative nozzle manifold design ensures that the spray is uniform across the duct and is largely absorbed within a short distance up to 1.3m. The water evaporates quickly and efficiently into the air-stream and avoids the need for long humidifier duct sections.

### **No compressed air**

Precision manufactured stainless steel, high-pressure nozzles deliver an extremely fine spray of water droplets, without the need for compressed air.

### **Low maintenance pump**

The water-lubricated, high-pressure stainless steel pump requires no oil or belt changes and is guaranteed for 8,000 hours, ensuring years of trouble-free operation. It is mounted directly onto a high quality, energy efficient Grundfos electric motor.

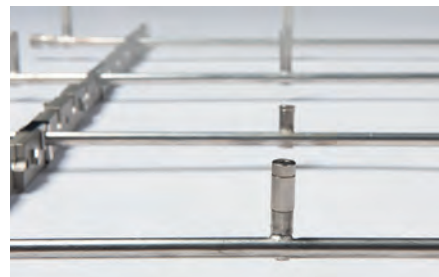

**GRUNDFOS** 



Running costs can be 65% cheaper than an electric steam humidifier

## Low energy humidification and adiabatic cooling

In-duct adiabatic humidifiers can significantly reduce the operating cost of a building's humidity control when compared to traditional electric steam humidifiers.

As moisture is absorbed using heat from the air, rather than by electrically heating water to create steam, the main energy source can be shifted from electricity to gas. By warming the air prior to the humidifier with gas-fired heating, the exact same amount of energy is consumed but as gas is much cheaper, the humidification system's overall operating cost is reduced.

If it is possible to recover waste heat from the building to pre-heat the air stream prior to the humidifier, the energy cost of Condair HP humidification is a tiny fraction in comparison to using electric steam humidifiers.

### Adiabatic cooling

The Condair HP can also be used in the summertime to provide low energy adiabatic cooling to an air handling unit. For every 1kg of humidity absorbed by the air around 0.68kW of cooling is also delivered. As a single Condair HP can provide up to 1,300kg/h, the system can supply approximately 884kW of adiabatic cooling per hour, while operating on around just 2.2kW of electricity.

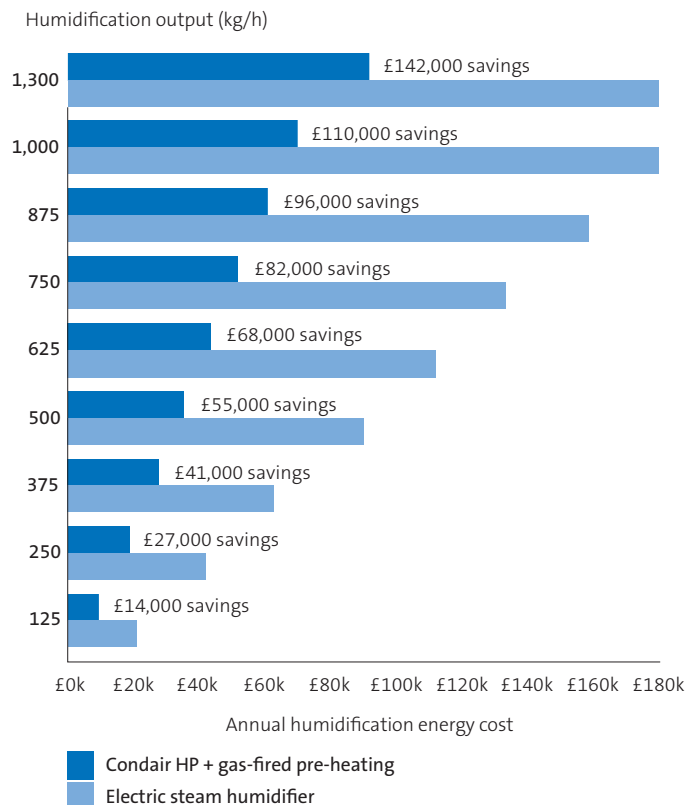

Based on full humidifier output for 2,500 hours per year, gas at 3p/kWh and 80% efficient pre-heating, and electricity at 9p/kWh and a 94% efficient electric steam humidifier.



Hygiene is ensured with regular flush cycles to reduce bacterial growth in the water

## Safe and hygienic operation

The Condair HP operates on pure reverse osmosis (RO) water, ensuring the water being introduced to the air is hygienic.

Regular automatic flush and drain cycles prevent water from remaining in the pipelines of the humidifier long enough to stagnate.

An optional ultra-violet sterilisation system on the water pump station offers additional safeguards against microbial growth.

Condair HP pump stations are manufactured according to HACCP principles.



## Options

- Reverse osmosis water treatment system
- Conductivity sensor
- Integrated water meter
- UV water treatment
- Self-regenerating ion exchange softener
- Activated carbon pre-filters
- BMS gateway board (LonWorks or BACnet IP/BACnet MSTP)
- High capacity variable frequency drive (VFD)

## System overview with RO option

- 1 RO water storage tank
- 2 Control panel
- 3 RO membrane
- 4 High-pressure pump
- 5 RO pump
- 6 Stage valve block
- 7 Nozzle grid
- 8 Droplet separator

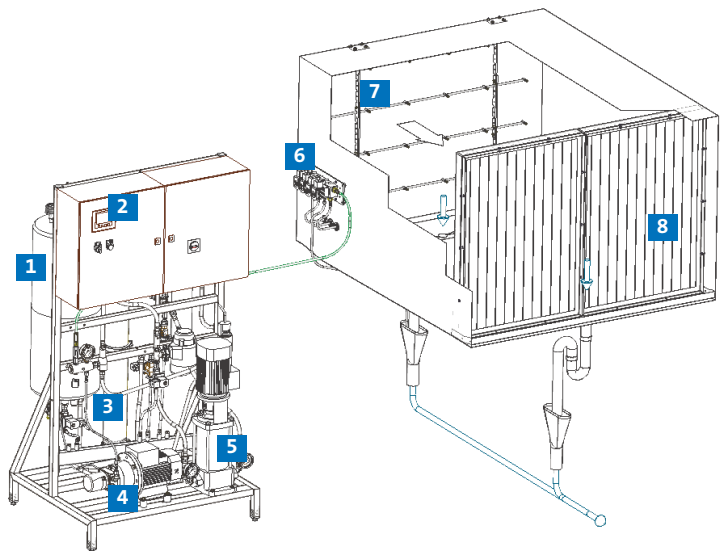

## Technical data HP

Model reference	HP100	HP200 VFD	HP300	HP500 VFD	HP500	HP800 VFD	HP800	HP1300 VFD
Capacity	100l/h	200l/h	265l/h	500l/h	440l/h	850l/h	790l/h	1300l/h
Width AHU/duct (min - max)	850mm x 4900mm							
Height AHU/duct (min - max)	300mm x 3000mm							
AHU/duct air velocity	0.5-4m/s							
Control accuracy	7 stages +/-5%RH or 15 stages +/-4%RH							
Power supply	400V 3Ph 16A							
Power consumption	0.5kW	0.8kW	0.75kW	1.5kW	1.2kW	2.2kW	2.4kW	3.5kW
Pump station weight	50-65kg		55-70kg		65-80kg		75-90kg	
Pump station dimensions HxWxD	1300 x 660 x 500mm							
Water quality required	5-30µS/cm							
Water pressure required	1-4 bar							
Pump station IP rating	IP54							

## Technical data HPRO

Model reference	HPRO 100	HPRO 300	HPRO 500	HPRO 800
Capacity	100l/h	265l/h	440l/h	750l/h
Width AHU/duct (min - max)	850mm x 4900mm			
Height AHU/duct (min - max)	300mm x 3000mm			
AHU/duct air velocity	0.5-4m/s			
Control accuracy	7 stages: ±5%RH or 15 stages: +/-4%RH			
Power supply	400V 3Ph 16A			
Power consumption	0.87kW	1.5kW	2.2kW	3.77kW
Pump station weight	125kg	130kg	240kg	270kg
Pump station dimensions HxWxD	1600 x 860 x 700mm			1600 x 1400 x 700mm
Dimensions external RO tank HxWxD	Integrated		955 x 600 x 600mm	1250 x 800 x 800mm
RO water tank capacity	50l		200l	500l
Water quality required	250-1000µS/cm			
Water pressure required	2.5 - 7.0 bar			
Pump station IP rating	IP54			