

EFJohnson®

5100 ES Models II/III Portable Radio

700 / 800 MHz

Operating Manual



- Project 25
 - Conventional
 - Trunked

- Analog FM Conventional
- SMARTNET® / SmartZone®

Part of Part Number 002-5100-72000CD
December 2006

EFJohnson[®]

5100 ES Models II/III Portable Radio Operating Manual

700 / 800 MHz

Project 25 Conventional and Trunked
Analog and Digital Conventional
SMARTNET[®] / SmartZone[®]

7.2 VDC
2.5 Watt (700 MHz), 3 Watt (800 MHz)

Part of Part Number 002-5100-72000CD
December 2006

Copyright © 2006 by EFJohnson

The EFJohnson logo, PC Configure™, Trunked IP25™, and Call Guard® are trademarks of EFJohnson. All other company and/or product names used in this manual are trademarks and/or registered trademarks of their respective manufacturers.

Information in this manual is subject to change without notice.

5100 ES Model II/III Portable Radio Operating Manual

December 2006

EFJohnson®

5100 ES Models II/III Portable Radio Operating Manual

December 2006

Table of Contents

1	Features	1-1
	General Features	1-1
	Conventional Features	1-2
	SMARTNET/SmartZone Features	1-3
	Project 25 Trunked Features	1-3
2	Controls and Display	2-1
	Front Panel Controls	2-1
	Top Panel Controls	2-3
	Side Controls	2-4
	Display	2-5
3	General Operation	3-1
	Turning Power On and Setting Volume	3-1
	Power Up	3-1
	Standard and Soft Power Down	3-1
	Setting Volume Level	3-3
	Power-Up Password	3-4
	Zone and Channel Select	3-4
	Zone Select	3-4
	Channel Select	3-5
	Direct Zone/Channel Selection	3-5
	Combined Zone and Channel	3-7
	Dynamic Zone	3-7
	Battery and Accessory Connector	3-8
	Battery Removal/Installation	3-8
	Low Battery Indication	3-9
	Battery Charging	3-9
	Beltclip Installation	3-10
	Connecting an Accessory	3-10

Table of Contents (continued)

Backlight	3-11
Keypad Lock	3-11
Setting Squelch	3-12
Transmit Disable	3-12
Radio Operating Modes	3-12
Conventional Mode	3-13
SMARTNET/SmartZone Mode	3-13
P25 Trunked Mode	3-14
Systems, Channels, and Zones	3-14
Systems	3-14
Channels	3-15
Zones	3-15
Radio Tune Test Mode	3-15
RF Test Mode	3-16
Control Top and Keypad Test Mode	3-18
4 Radio-wide Features	4-1
<hr/>	
Option Switches	4-1
Feature Enable/Disable	4-2
Menu Mode	4-3
Time-Out Timer	4-4
Home Zone/Channel Select	4-4
Power Output Select	4-5
Alert Tone Select	4-5
Surveillance Mode	4-6
Scanning	4-6
Priority Scanning	4-6
Radio Wide Scanning	4-7
Scan Hold Time	4-7
Transmitting in the Scan Mode	4-8
Priority Scan Mode:	4-8
Radio Wide Scan Mode:	4-8
Nuisance Channel Add/Delete	4-8
Scan Lists	4-9
Priority Scan Lists	4-9
Determining Channels in Priority Scan List	4-9
Selecting a Priority Scan List	4-9
Editing a Priority Scan List	4-10
Radio Wide Scan Lists	4-11
Determining Channels in Radio Wide Scan List	4-11
Editing a Radio Wide Scan List	4-11

Table of Contents (continued)

5 Conventional Mode Features	5-1
Monitoring Before Transmitting	5-1
Automatic Channel Monitoring	5-1
Manual Channel Monitoring	5-2
Monitor Mode	5-2
Busy Channel Lockout	5-3
Call Guard Squelch	5-3
Call Guard Squelch Enable/Disable	5-4
Tone Call Guard Squelch	5-4
Digital Call Guard Squelch	5-4
Selective Squelch Code Select (CTCSS/DCS/NAC)	5-5
Penalty Timer	5-6
Conversation Timer	5-6
Repeater Talkaround	5-6
Displaying Transmit/Receive Frequency	5-7
Emergency Alarm and Call	5-7
Emergency Alarms	5-7
Emergency Calls	5-8
Emergency Hot Mic	5-9
Placing an Emergency Call	5-9
External Emergency Switch	5-9
Conventional Mode Scanning	5-10
Transmitting in Scan Mode	5-10
Priority Channel Sampling	5-10
Changing the Priority Channel	5-11
Standard Conventional Calls	5-12
Placing a Standard Conventional Call	5-12
Receiving a Standard Conventional Call	5-12
ANI Signaling Options	5-12
DTMF/ANI Signaling	5-13
Single Tone Encoder	5-13
MDC1200 Compatibility	5-13
Five-Tone Signaling	5-14
Clone Mode	5-14
Wireless Cloning	5-15
Cloning Procedure	5-15
Project 25 Mode Features	5-16
Unit ID Code	5-16
Group ID Code	5-16
Network Access Code	5-16
P25 Group Calls	5-16
Changing a Channel Talk Group	5-17
P25 Unit Calls	5-17
P25 Conventional Telephone Calls	5-18
Access/De-Access Codes	5-19
Placing a Telephone Call	5-19

Table of Contents (continued)

Answering a Telephone Call	5-20
Call Alert	5-20
Messaging	5-21
Status Messaging	5-21
P25 Packet Data	5-22
Keypad Programming	5-22
Menu Description	5-23
Zone Password	5-24
Zone Change Parameter	5-24
Channel Change Parameter	5-24
System Parameters	5-25
Channel Parameters	5-25
CTCSS/DCS Squelch Control (Analog Channel)	5-26
NAC Squelch Control (Project 25 Channel)	5-27
6 SMARTNET/SmartZone/P25 Trunked Features	6-1
<hr/>	
Analog and Digital Operation	6-1
Viewing Unit ID	6-1
Standard Group Calls	6-2
Placing a Standard Group Call	6-2
Receiving a Standard Group Call	6-3
Private (Unit-To-Unit) Calls	6-3
Placing an Enhanced Private Conversation Call	6-4
Placing a Standard Private Conversation Call	6-5
Receiving a Private Call (All Types)	6-6
Telephone Calls	6-6
Placing a Telephone Call	6-7
Answering a Telephone Call	6-8
Call Alert	6-8
Answering a Page	6-8
Enhanced Private Conversation Mode	6-9
Standard Private Conversation Mode	6-9
Initiating a Page	6-9
Messaging	6-9
Sending Status Conditions	6-10
Emergency Alarm and Call	6-10
Emergency Alarms	6-11
Emergency Calls	6-12
Emergency Hot Mic	6-12
Placing an Emergency Call	6-12
External Emergency Feature	6-13
Failsoft Operation	6-13
SMARTNET/SmartZone/P25 Trunked Scanning Features	6-13
Priority Talk Group Sampling	6-14
Dynamic Regrouping	6-14

Table of Contents (continued)

SmartZone and P25 Trunked Unique Features	6-15
Busy Override	6-15
Site Trunking	6-15
Determining Current Site and Searching For New Site	6-16
Locking/Unlocking a Site	6-16
Auto Site Search	6-16
ZoneFail Site Lock	6-16
P25 Wide Area Scan	6-17
Normal P25 and SmartZone Control Channel Hunt	6-17
Talkgroup Steering Via System Access Permissions	6-17
P25 Wide Area Scan	6-17
7 Miscellaneous	7-1
<hr/>	
Signaling Tones	7-1
Error Messages	7-4
System Operator Programming	7-7
Speaking Into Microphone	7-7
Operation At Extended Range	7-7
Licensing	7-7
Radio Service	7-7
8 Determining Available Options	8-1
<hr/>	
Upgrading A Radio With New Options	8-2
Using PC Configure To Determine Options	8-3
9 Password Description	9-1
<hr/>	
Programming Passwords	9-1
Lost Passwords	9-1
Changing Password	9-2
Password Entry Procedure	9-2
Password Description	9-2
User (Power-On) Passwords	9-2
Download/Upload Passwords	9-3
Master Password	9-3
Zone Password	9-3
10 Secure Communication (Encryption)	10-1
<hr/>	
Encryption Algorithms	10-1

Table of Contents (continued)

SecureNet™	10-1
AES (Advanced Encryption Standard)	10-2
Encryption Available With Various Channel Types	10-2
FIPS and Non-FIPS Modes	10-2
Encryption Keys	10-2
Key and Algorithm IDs	10-3
PID/SLN Key Management Modes	10-3
Maintaining Keys in Memory	10-4
Encryption Key Select	10-4
Encryption Key Erase	10-5
Encryption Icon Operation	10-5
Clear/Secure Strapping	10-5
Transmit Mode Options	10-5
Receive Mode Options	10-6
Talk Group Encryption Override	10-6
OTAR (Over-The-Air Rekeying)	10-6
Encryption Key Types	10-7
Keysets	10-7
Key Management Facility	10-8
Message Number Period (MNP)	10-9
Definitions	10-9
Radio Setup For Encryption	10-11
General Encryption Setup	10-11
Additional Setup For OTAR	10-12
Additional PC Configure Programming For OTAR	10-12
Motorola Third-Party RNC Registration	10-13
Programming By Keyloader	10-13
Radio OTAR Capabilities	10-14
SEM 5100 ES	10-14
OTAR Messages That Are Supported	10-14
OTAR Option Switches	10-15
Additional Functions Selectable by 5100 ES Menu	10-15

List of Figures

Figure		Page
2.1	Front Panel Controls	2-1
2.2	Top Panel Controls	2-3
2.3	Side Controls and Jacks	2-4
2.4	Graphical Display	2-5
3.1	Enhanced Soft Power feature	3-2
3.2	Battery Removal	3-8
3.3	Beltclip Installation	3-10
3.4	Accessory Connector	3-11
4.1	Menu Mode Buttons	4-3
5.1	Keypad Programming Menu Flowchart	5-23
8.1	PC Configure Radio Options Screen	8-2
10.1	Key Selection Example	10-3
10.2	Keypad Diagram	10-8

List of Tables

Table		Page
2.1	LED Indicators	2-3
3.1	Initial Messages	3-16
3.2	RF Test Mode Frequencies (MHz)	3-17
3.3	RF Test Mode Environments	3-17
3.4	Control Top and Keypad Test Mode Display Messages	3-18
4.1	Programmable Functions	4-1
4.2	Features which May Be Enabled/Disabled using the Function Button	4-2
7.1	Tones for the 5100 ES Radios	7-1
7.2	LED Indicators	7-4

Safety Requirements

RF Energy Exposure Awareness and Control Information, and Operational Instructions for FCC Occupational Use Requirements

Before Using Your Portable Two-Way Radio, Read This Important RF Energy Awareness And Control Information And Operational Instructions To Ensure Compliance With The FCC's RF Exposure Guidelines.

Note *This radio is intended for use in occupational/controlled conditions where users have full knowledge of their exposure and can exercise control over their exposure to meet FCC limits. This radio device is NOT authorized for general population, consumer, or any other use.*

This two-way radio uses electromagnetic energy in the radio frequency (RF) spectrum to provide communications between two or more users over a distance. It uses radio frequency (RF) energy or radio waves to send and receive calls. RF energy is one form of electromagnetic energy. Other forms include, but are not limited to, electric power, sunlight and x-rays. RF energy, however, should not be confused with these other forms of electromagnetic energy, which when used improperly can cause biological damage. Very high levels of x-rays, for example, can damage tissues and genetic material.

Experts in science, engineering, medicine, health and industry work with organizations to develop standards for exposure to RF energy. These standards provide recommended levels of RF exposure for both workers and the general public. These recommended RF exposure levels include substantial margins of protection. All two-way radios marketed in North America are designed, manufactured and tested to ensure they meet government established RF exposure levels. In addition, manufacturers also recommend specific operating instructions to users of two-way radios. These instructions are important because they inform users about RF energy exposure and provide simple procedures on how to control it. Please refer to the following web sites for more information on what RF energy exposure is and how to control your exposure to assure compliance with established RF exposure limits.

- <http://www.fcc.gov/oet/rfsafety/ef-faqs.html>
- <http://www.osha.gov/SLTC/radiofrequencyradiation/index.html>

Federal Communications Commission Regulations

The FCC rules require manufacturers to comply with the FCC RF energy exposure limits for portable two-way radios before they can be marketed in the U.S. When two-way radios are used as a consequence of employment, the FCC requires users to be fully aware of and able to control their exposure to meet occupational requirements. Exposure awareness can be facilitated by the use of a product label directing users to specific user awareness

information. Your EFJohnson two-way radio has a RF exposure product label. Also, your EFJohnson user manual, or product manual, or separate safety booklet includes information and operating instructions required to control your RF exposure and to satisfy compliance requirements.

Compliance with RF Exposure Standards

Your EFJohnson two-way radio is designed and tested to comply with a number of national and international standards and guidelines (listed below) for human exposure to radio frequency electromagnetic energy. This radio complies with the IEEE and ICNIRP exposure limits for occupational/controlled RF exposure environment at operating duty factors of up to 50% transmitting and is authorized by the FCC for occupational use only. In terms of measuring RF energy for compliance with the FCC exposure guidelines, your radio radiates measurable RF energy only while it is transmitting (during talking), not when it is receiving (listening) or in standby mode.

Note *The approved batteries supplied with this radio are rated for a 5-5-90 duty factor (5% talk-5% listen - 90% standby), even though this radio complies with the FCC occupational RF exposure limits and may operate at duty factors of up to 50% talk.*

Your EFJohnson two-way radio complies with the following RF energy exposure standards and guidelines:

- United States Federal Communications Commission, Code of Federal Regulations; 47 CFR §§ 1.1307, 1.1310, 2.1091 and 2.1093
- American National Standards Institute (ANSI) / Institute of Electrical and Electronic Engineers (IEEE) C95. 1-1992
- Institute of Electrical and Electronic Engineers (IEEE) C95.1-1999 Edition

RF Exposure Compliance and Control Guidelines and Operating Instructions

To control your exposure and ensure compliance with the occupational/controlled environment exposure limits, always adhere to the following procedures.

Guidelines

- Do not remove the RF Exposure Label from the device.
- User awareness instructions should accompany the device when it is transferred to other users.
- Do not use this device if the operational requirements described herein are not met.

Operating Instructions

- Transmit no more than the rated duty factor of 50% of the time. To transmit (talk), push the Push-To-Talk (PTT) button. To receive calls, release the PTT button. Transmitting 50% of the time, or less, is important because this radio generates measurable RF energy exposure only when transmitting (in terms of measuring for standards compliance).
- Hold the radio in a vertical position in front of face with the microphone (and the other parts of the radio, including the antenna) at least one inch (2.5 cm) away from the nose. Keeping the radio at the proper distance is important because RF exposures decrease with distance from the antenna. The antenna should be kept away from eyes.
- When worn on the body, always place the radio in an EFJohnson approved clip, holder, holster, case, or body harness for this product. Using approved body-worn accessories is important because the use of EFJohnson or other manufacturer's non-approved accessories may result in exposure levels which exceed the FCC's occupational/controlled environment RF exposure limits.
- If you are not using a body-worn accessory and are not using the radio in the intended use position in front of the face, then ensure the antenna and the radio are kept at least one inch (2.5 cm) from the body when transmitting. Keeping the radio at the proper distance is important because RF exposures decrease with increasing distance from the antenna.
- Use only EFJohnson approved supplied or replacement antennas, batteries, and accessories. Use of non-EFJohnson approved antennas, batteries, and accessories may exceed the FCC RF exposure guidelines.
- For a list of EFJohnson approved accessories, see the service manual or marketing accessory lists or contact the E.F. Johnson Company.

Contact Information

Toll-Free: 1-800-328-3911

FAX: 972-818-0639

E-Mail: customerservice@efjohnson.com. You can also e-mail a person directly if you know their first initial/last name (example: jsmith@efjohnson.com).

You may also contact the Customer Service Department by mail. Please include all information that may be helpful in solving your problem. The mailing address is as follows:

E.F. Johnson Company
Customer Service Department
1440 Corporate Drive
Irving, TX 75038-2401

Electromagnetic Interference

This device complies with Part 15 of the FCC rules. Operation is subject to the condition that this device does not cause harmful interference. In addition, changes or modification to this equipment not expressly approved by the E.F. Johnson Company could void the user's authority to operate this equipment (FCC Rules, 47CFR Part 15.19).

Usage Compatibility

Do NOT operate it in areas that are sensitive to RF energy such as aircraft, hospitals, blasting sites, and fuel storage sites. Areas with potentially flammable atmospheres are usually, but not always, clearly posted. These may include gas stations, fuel and chemical storage and transfer stations, below deck on boats, and areas where the air contains flammable chemicals or particles such as grain dust or metal powders.

Battery Disposal

Dispose of the nickel metal-hydride (NiMH) battery used by this radio in accordance with local regulations. Do NOT dispose of it in fire because it can explode. Also, do not short the terminals because it may become very hot.

Features

Note *The availability of many of the following features is controlled by the model of your radio, factory coding of your radio, installed options, firmware version, and field programming. Refer to Sections 8 for more information.*

1.1 General Features

- The following operating modes are programmable:
 - Conventional analog
 - Conventional APCO Project 25 (digital)
 - Trunked APCO Project 25 (digital)
 - SMARTNET™/SmartZone® trunked (analog or digital)
- Up to 32 zones with 16 channels each (512 channels total) are standard.
- Large graphic display with backlight
- 16-position channel select switch
- Three-position rotary option switch
- Up to nine (limited keypad) or 21 (DTMF keypad) programmable option switches
- Each option button programmable with a different function for each operating mode (Conventional, SMARTNET/SmartZone, Trunked P25)
- Menu mode
- AES 256-bit FIPS 140-2 approved encryption available on P25/digital channels
- DES 64-bit encryption available on analog channels, DES-OFB on digital channels (see Section 10)
- Emergency calls for high priority system access
- Priority (standard) and Radio Wide scan modes with user programmable scan lists

- User selectable high and low power output
- Surveillance mode
- Time-out timer
- Keypad lock to prevent accidental key presses
- Power up password to prevent unauthorized use.
- Programmable and user adjustable tone volume
- Programmable minimum volume level
- Soft power down to prevent accidental power off
- Operates on both wide and narrow band channels
- Adjust Contrast values of LCD display

1.2 Conventional Features

- Up to 512 channels or talk groups programmable
- Repeater talk-around
- Carrier or Call Guard® (CTCSS/DCS) controlled squelch on analog channels, NAC and talk group IDs on P25 channels
- Normal/selective squelch selectable by option switch or menu
- Monitor mode selectable by option switch or menu
- Time out timer penalty and conversation timers
- Dual priority channel sampling when scanning (analog and digital channels)
- Busy channel lockout (transmit disable on busy)
- Unit calls on P25 channels
- Telephone calls on P25 channels with over dialing.
- Cloning capability using a cable or wireless connection (see Section 5.13)
- Emergency alarms and calls to alert a dispatcher of an emergency condition
- Single tone encoder controllable by user on analog channels
- ANI (Automatic Number Identification) on analog channels
- MDC1200 ANI and Emergency Alert support
- Call Alert™ on P25 channels (send and receive pages)
- Predefined messages (up to 16) can be sent to a dispatcher (P25 mode)
- Predefined status conditions (up to eight) can be sent to a dispatcher (P25 mode)
- OTAR (Over-The-Air-Rekeying) compatible (P25 channels).
- Keypad programming with password access (Federal Government users only)

1.3 SMARTNET/SmartZone Features

- Up to 512 talk groups programmable (channels select talk groups)
- Group, Enhanced Private Conversation™, standard Private Conversation, and Telephone calls
- Emergency alarms to alert a dispatcher of emergency conditions
- Emergency calls for high priority system access
- Failsoft operation on a predefined conventional channel if trunked system fails
- Priority group calls detected while listening to other group calls when scanning
- Call Alert™ (send and receive pages)
- Predefined messages (up to 16) can be sent to a dispatcher
- Predefined status conditions (up to 8) can be sent to a dispatcher
- Dynamic regrouping (dispatcher can automatically gather users on a channel to receive a message)
- Roaming (SmartZone only)

1.4 Project 25 Trunked Features

- Up to 512 talk groups programmable (channels select talk groups)
- Group and Unit Calls
- Telephone calls with over dialing
- Emergency alarms to alert a dispatcher of emergency conditions
- Emergency calls for high priority system access
- Failsoft operation on a predefined conventional channel if trunked system fails
- Priority group calls detected while listening to other group calls when scanning
- Call Alert™ (send and receive pages)
- Predefined status conditions (up to eight) can be sent to a dispatcher
- Dynamic regrouping (dispatcher can automatically gather users on a channel to receive a message)
- Roaming

Features

Controls and Display

2.1 Front Panel Controls

Note The location of these controls is shown in Figure 2.1.

Figure 2.1 Front Panel Controls



Microphone - The microphone is located behind the small opening shown in Figure 2.1. For best results, hold the radio 2-3 inches from your mouth and speak at a normal conversational level. Do not shout since it distorts your voice and does not increase range.

Display - This is a graphical LCD (Liquid Crystal Display). The display backlight can be programmed to turn on when any key is pressed or when the Backlight option switch is pressed or menu parameter selected (see Section 3.5).

Up/Down Switch - Selects zones when multiple zones are programmed (see Section 3.3). Pressing the upper part of the switch selects the next higher number and pressing the lower part selects the next lower number. This control also provides up/down select in the menu mode and in other modes when up/down select is required.

<F1> - In menu mode (see Section 4.3), functions as a step back and exit switch. If menu mode is not used, it is a programmable option switch.

<F2> - Selects the menu mode when that mode is enabled by programming. Also functions as an Enter or Select switch in the menu and other modes. If menu mode is not used, it is a programmable option switch.

<F3>, <F4> - Programmable option switches.

DTMF Keypad - The full keypad DTMF models include the 12 keys required to dial telephone and unit ID numbers.

Speaker - The radio speaker is located near the bottom of the front panel. When a speaker/microphone is used, it is automatically detected when the Opt Sel 1 line of the accessory connector is pulled low. The logic then automatically disables the internal speaker.

2.2 Top Panel Controls

Figure 2.2 Top Panel Controls

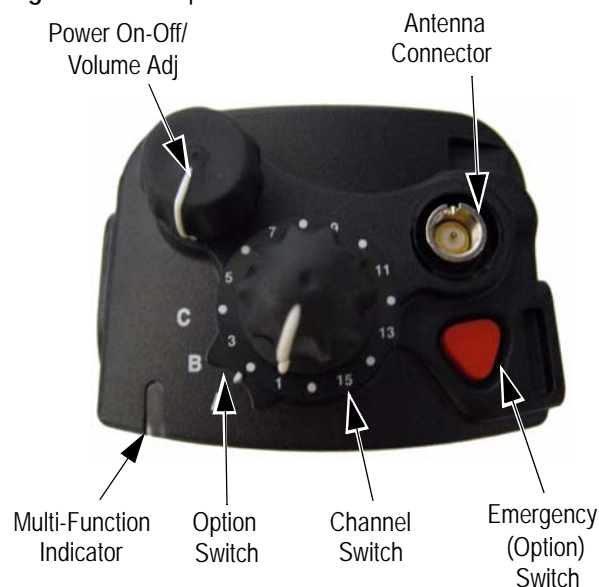

Multi-Function Indicator - Indicates the following conditions:

Table 2.1 LED Indicators

LED Color	LED Duration	Description
Red	On	Tx: clear
Red	125 ms ON 125 ms OFF	Tx: CLEAR with low battery Tx: trunking system busy
Red	125 ms ON 125 ms OFF 125 ms ON 750 ms OFF	Rx: Secure Group
Red	750 ms ON 125 ms OFF	Rx: Secure individual call
Green	ON	Rx: clear conventional or trunking
Green	750 ms ON 125 ms OFF	Rx: clear individual call
Orange	Continuous until Self Test complete	Self Test state
Orange	ON	Tx: Secure
Orange	125 ms ON 125 ms OFF	Tx: SECURE with low battery

Note *This indicator is disabled if the Surveillance mode is programmed (see Section 4.8).*

On-Off/Volume - Turning the knob clockwise turns power on and sets the volume level. Turning it counterclockwise to the detent turns power off. The minimum volume level can be set by programming. Soft power down can be programmed as described in Section 3.1.2, and the volume control can be disabled as described in Section 3.1.3.

Channel Switch - This 16-position switch selects up to 16 channels in the current zone. Additional zones can be programmed to allow up to 512 channels to be selected by this switch. This control can be disabled as described in Section 3.3.

Rotary Option Switch - This is a three-position switch that can be programmed to control various options. The “A” position is “on” and the “B” and “C” positions are “off” (see Section 4.1). When this switch is programmed to select zones, “A” selects Zone 1, “B” Zone 2, and “C” Zone 3 if applicable.

Antenna Connector - This is the connection point for the antenna. Make sure the antenna is tight before using the radio.

Emergency Switch - This switch or some other option switch can be programmed as an Emergency switch to alert a dispatcher of an emergency condition. Refer to Sections 5.9 and 6.9 for more information. This switch can also be programmed for other functions.

2.3 Side Controls

Figure 2.3 Side Controls and Jacks



PTT (Push-To-Talk) Switch - This switch is pressed to turn the transmitter on to transmit a message. It is then released to listen. Transmitting is indicated when the top panel indicator is constant red or  is displayed (surveillance mode only, see Section 4.8).

Option Switches 1, 2, and 3 - Each of these switches can be programmed to control a specific function (see Section 4.1). In addition, they can be programmed for soft power down (see Section 3.1.2). These switches can also be temporarily disabled by the keypad lock feature (see Section 3.6) or permanently disabled.

Battery - To remove the battery, press the release button on the bottom and pivot the bottom of the battery outward.

Accessory Connector - This is the connection point for optional accessories such as a speaker/microphone or earphone. It is also the connection point for the computer when programming the radio or for data equipment when the P25 Packet Data feature is used (see Section 5.14.10).

2.4 Display

Figure 2.4 Graphical Display



The front panel display is shown above. Icons are typically shown in the upper part of the display and text messages in the lower part. The icons are as follows:

- When the scan or the scan list edit mode is enabled, indicates that the displayed channel is in the scan list and scanned (see Section 4.9).
- When the scan or the scan list edit mode is enabled, indicates that the displayed channel is a priority channel. If dual priority is used, **F₂** indicates that it is a second priority channel.
- Low battery indication (see Section 3.4.2).
- Voice encryption is enabled or an encrypted call is being received. This indication flashes when an encrypted call is received on a digital channel (see Section 10.2.6).
- Priority or radio wide scanning is enabled (see Section 4.9).
- In the surveillance mode only (see Section 4.8), indicates that the transmitter is keyed. This icon is displayed in the preceding scan icon location, and they do not conflict because the scan icon is never displayed in the transmit mode.
- Repeater talk-around is enabled (see Section 5.7).
- The Monitor mode is enabled by the Monitor option switch or menu parameter (see Section 5.2). The radio can also be programmed so this icon is displayed when the Normal mode is selected by the Normal/Selective function (see Section 5.4.1).
- Keypad programming or another mode is enabled which allows the user to edit radio parameters.



An interconnect (telephone) call is in progress (see Section 6.5).



A Project 25 or SMARTNET/SmartZone private (unit-to-unit) call is in progress.

General Operation

3.1 Turning Power On and Setting Volume

3.1.1 Power Up

Power is turned on and off by the top panel On-Off/Volume switch. When power is initially turned on, the following events occur:

- The EFJohnson logo is displayed
- The firmware version number is displayed.
- A self test is performed.
- The currently selected zone is displayed.
- The Individual (Unit/Unique) ID programmed for the currently selected system is displayed.
- A tone sounds (if tones are enabled) and the alias of the selected talk group is displayed continuously.

Programming determines if the radio powers up on the last selected zone or the pre-programmed home zone. Refer to Section 3.3 for information on the channel that is selected. The minimum volume level may be set by programming. This can prevent missed messages resulting from inadvertently turning the volume to an inaudible level.

3.1.2 Standard and Soft Power Down

To turn power off, rotate the On-Off/Volume control counterclockwise until a click occurs. Power may remain on for an instant after turn-off occurs.

The soft power down feature prevents users from accidentally powering off the radio. A soft power down feature can be programmed to prevent radio power from being turned off by accidentally turning the on-off/volume control. Any side button can be programmed for this function in addition to its normal function. To turn power off, press this button during or after power is turned off in the normal manner (there is no time out).

The soft power down feature prevents users from accidentally powering off the radio. Any side option button could be programmed to protect the power/volume knob. To power off the radio, the side button had to be pressed during or just after the knob was turned to the off position.

The enhanced soft power down feature adds a “standby” mode which mutes audio, turns off lights, and can block a combination of buttons and switches. Settings for the new functionality are on the second page of the **Global** tab in PC Configure™.

Figure 3.1 Enhanced Soft Power feature

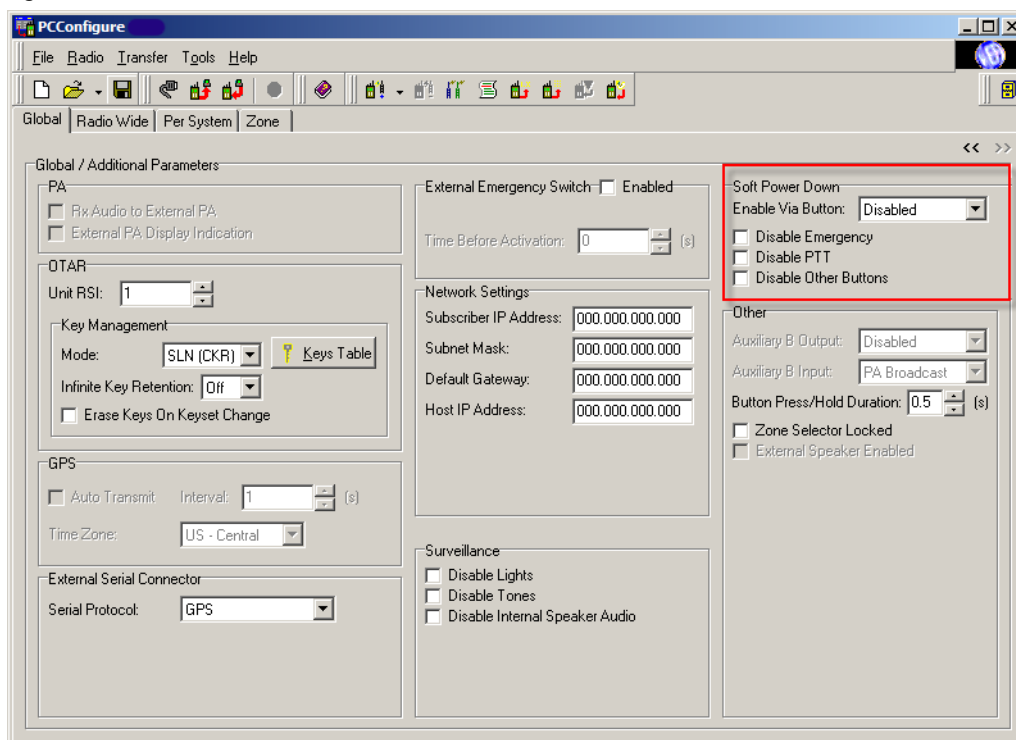

Enhanced Soft Power Down has two modes of operation:

The Normal Mode is enabled when no “disable” check boxes are selected. If the power/volume knob is turned off nothing happens until the programmed side button is pressed.

The Standby Mode is enabled when any combination of the “disable” check boxes is selected. When the power/volume knob is turned off, the radio displays “Standby”, audio is muted, and the indicator lights are turned off. The radio remains in “standby” until the power knob is turned back on or the user presses a button that has not been disabled.

The following fields must be completed in PC Configure (on the second page of the **Global** tab).

Enable Via Button - This combo box allows the user to choose which side button protects the power knob. Pressing this side button while the power/volume knob is in the off position will power down the radio.

Disable Emergency - Checking this check box disables the programmed emergency button when the radio is in standby mode.

Disable PTT - Checking this check box causes the radio to ignore the PTT button while in standby.

Disable Other Buttons - Checking this check box disables the other buttons (and the channel selector) when the radio is in standby mode.

Note *No hardware is shut down during standby. This means that power savings while in standby are negligible allowing the user to have immediate access to the system since they do not have to power components back up. The volume is set to half of maximum when the radio exits standby due to a button press or switch change.*

3.1.3 Setting Volume Level

The volume level is adjusted by the top panel volume control knob or by option buttons programmed for the Up/Down volume function. When the buttons are used, the volume control function of the knob is disabled (it is still used to switch power). Volume buttons may be used instead of the knob, for example, if accidental turning of the volume knob is a problem.

When the volume control buttons are used, the number of steps (ticks) required to change the volume from the minimum level to maximum level is programmable for 1-50. For example, if "20" is programmed, there are 20 adjustment steps from minimum to maximum volume. Only one volume control button can be programmed if desired and wrap-around then occurs after the maximum or minimum level is selected.

The radio can also be programmed so that volume control is also be disabled by the Keypad Lock feature.

The relative volume level can be determined by the position of the index on the volume knob or by a reference signal as follows:

- If a key press tone is enabled, a short tone sounds when a key is pressed.
- If a conventional channel is selected and the Monitor option switch or menu parameter is programmed, pressing that switch unscelches the receiver and either voice or background noise is heard (see Section 5.2). If a SMARTNET/SmartZone or P25 Trunked channel is selected, the receiver cannot be manually unscelched.

3.2 Power-Up Password

The power-up password feature prevents unauthorized use of the radio by disabling it when power is turned on until the proper password is entered. This feature is enabled or disabled by programming.

When this feature is enabled, “Enter Pswd” is briefly displayed when power is turned on. The password can be 1-8 digits in length, and consists of digits 0-9. It is entered as follows. If an incorrect password is entered, “Incorrect” is displayed and it must be re-entered.

DTMF Keypad Models - Enter the password using the 1-8 keys and then press the Enter <F2> key when finished. If a mistake is made, the last digit can be erased by pressing the <F1> (Clear) key.

Limited Keypad Models - Select the proper number for each position by pressing the Up/Down switch. When the proper number for a position is displayed, select it and move on to the next position by pressing the <F2> (Enter) key. If the password is less than eight digits, press <F2> twice after the last digit.

An enhanced password scheme allows up to four power-on (user) passwords, download and upload passwords, and a master password to be programmed.

The current User password can be changed if the “Set User Password” option switch or menu parameter is programmed. Selecting this function displays prompts for entering and confirming a new password. It is recommended that a number key not be used for this function because the password mode is exited if that key is pressed to enter a number. Refer to Section 9 for more information on passwords.

3.3 Zone and Channel Select

The selected zone and channel are selected and displayed as follows. For more information on zones and channels, refer to Section 3.9.4.

3.3.1 Zone Select

The front panel Up/Down switch briefly displays and changes the alias of the current zone. When not in special modes such as the menu mode, pressing either the top or bottom part of this switch once displays the alias of the current zone. Then quickly pressing it again changes the selected zone up or down. The rotary A/B/C switch on the top panel can also be programmed for zone select. The “A” position then selects Zone 1, “B” Zone 2, and “C” Zone 3 (if applicable).

After the highest programmed zone is displayed, wrap-around to the lowest programmed zone occurs and vice versa. The selected zone is also displayed briefly on power up. If the selected zone alias needs to be displayed continuously, it must be programmed as part of the channel alias.

The Up/Down switch on the front of the 5100 ES portable are typically used to scroll through the various Zones that a user needs to access. To eliminate inadvertently switching Zones if the radio is accidentally bumped and the Up/Down switch is pressed, a Zone Lock function is implemented. The Up/Down switch will not scroll through zones unless the Zone Lock switch is first pressed. If the Zone Lock switch is pressed, the Up/Down switch is available for scrolling. Upon five-ten seconds of inactivity, the Up/Down switch again is not usable for selecting a Zone. The Zone Lock function is programmable for any programmable button on the radio.

3.3.2 Channel Select

Channels are selected by the rotary 16-position switch on the top panel. The alias (identification) for the selected channel/group is displayed continuously during normal operation.

When an unprogrammed channel is selected, “Unprogramd” is displayed and a tone sounds (if tones are enabled). When conventional channels are selected and the Display Information option key or menu parameter is programmed, either the channel frequency or alias can be displayed (see Section 5.8).

The channel selector knob can also be disabled by programming. Channels must then be directly selected as described next (if applicable). It may be desirable to disable the channel select knob when direct selection is used in order to prevent confusion since the channel knob then may not indicate the selected channel.

The radio can also be programmed so that the channel select control is also be disabled by the Keypad Lock feature (Section 3.6) similar to the volume control described in Section 3.1.3.

3.3.3 Direct Zone/Channel Selection

The Direct Channel Select feature is available if the Channel Select option switch or menu parameter is programmed. This feature allows channels to be directly selected using the DTMF keypad numeric keys (DTMF models only) or Up/Down switch (all models).

For direct selection purposes, channels are numbered sequentially starting with the lowest zone. Each zone can be programmed with up to 16 channels, so Zone 1 channels are numbered 1-16, Zone 2 channels 17-32, and so on as shown below. For example, Zone 1/Channel 16 is selected by Channel 16, and Zone 2/Channel 16 is selected by Channel 32.

Seq. Ch. No.	Zone	Channel
1 ↓ 16	1	1 ↓ 16
17 ↓ 32	2	1 ↓ 16
33 ↓	3	1 ↓

Proceed as follows to select channels using this mode:

- 1 Enable the direct Channel Select mode by pressing the Channel Select option switch or selecting the “Chan Selct” menu parameter. The alias and sequential number of the current channel are alternately displayed.
- 2 Select the desired channel using the Up/Down keys or directly enter it using the 0-9 keys (if available). If using the 0-9 keys, the radio attempts to display the entered number after the 3rd digit is entered or approximately 2 seconds after the last key is pressed.
- 3 To exit the this mode and select the entered channel, press the Channel Select switch again or the <F2> key. To exit without changing the channel, press the <F1> key. This mode is also exited automatically without changing the channel after approximately one minute of no activity.

Note *The Channel Select function should probably not be assigned to a number key because pressing that key to select a channel then exits the select mode.*

Other features of this mode are as follows:

- When using the Up/Down keys, wrap-around to the lowest zone/channel occurs after the last channel in the highest programmed zone is displayed and vice versa. For example, if Zone 1/Channel 5 is the highest programmed channel, wrap-around occurs after Zone 1/Channel 16 is displayed.
- When an unprogrammed channel is displayed, the sequential channel number and “Unprogramd” are alternately displayed.
- If an invalid channel number is entered using the 0-9 keys, or the <F2> or Channel Select option switch is pressed with “Unprogrammed” displayed, an error tones sounds, “Invalid” is briefly displayed, and the displayed channel does not change.
- The rotary Channel Select switch may not correctly indicate the selected channel after direct channel selection is used. However, if this switch is enabled and rotated, it selects the channel it is indicating. For example, if the switch index is pointing to channel 3 and

channel 15 of the current zone is being displayed, rotating it to channel 4 selects channel 4 of the current zone.

- If the rotary Channel Select switch is enabled, the radio always powers up on the channel it is selecting.

If it is disabled, the radio can be programmed to power-up on the last selected or home channel number of the last selected or home zone. With the “Last Zone”/“Home Channel” configuration, the programmed home channel number of the last active zone is selected. If it is not programmed, “Unprogramm’d” is displayed. With earlier models, the last selected channel is displayed when powering up on the last selected zone, and channel 1 is displayed when powering up on the home zone.

3.3.4 Combined Zone and Channel

If the Combined Zone/Channel option is enabled, the flexibility to accommodate different number of character combinations for Zone and Talkgroup is implemented. The implementation for Combined Zone/Channel Display is as follows:

- Characters to Display Zone - (1-7)
- Space Between Zone / Talkgroup (optional)
- Characters to Display Talkgroup - This is a calculated field. (10 minus the number of Zone Chars minus 1 (if Space) or 0 (if No Space)).

The radios use the specified number of characters from the Zone and Talkgroup Alias fields to create the combined display text. If the Zone or Talkgroup Alias is larger than the number of characters specified, the radio truncates the alias to the specified number of characters so that both the Zone and the Talkgroup fit into the display.

3.3.5 Dynamic Zone

The Dynamic Zone feature provides users the ability to setup “Favorite Channels” in one dynamic zone, and allows the user to edit the channels without impacting any of the channels already programmed to the Dynamic Zone.

A menu item in the 5100 ES allows the user to add channels to the favorite Zone. The “Favorite” zone was added to the list of choices in PC Configure in the pull-down menu for Home Zone and Home 2 Zone. If The Favorite Zone is enabled in PC Configure, the user has the ability to change the channels that are in his favorites list, as follows:

- 1 Select the zone / channel to be placed into Favorites, using the zone/channel selectors.
- 2 Press the “Favorites” button or menu item for the 5100 ES (the radio remembers the current zone/channel).

- 3 Turn the up/down button to the location (1-16) where you want to store this favorite. The radio will automatically start at the first unprogrammed channel and if all channels are programmed, the radio will start at Channel 1.
- 4 To store the new channel in to the favorite zone, press the Select button which is <F2> on the portables. The radio will then return to its previous zone/channel.
- 5 To exit without saving, press the programmed Favorite button (the button you pressed to enter this mode). On the 5100 ES, you can also press the Cancel <F1> button.
- 6 Upon exit, the radio will return to its previous zone/channel.

3.4 Battery and Accessory Connector

3.4.1 Battery Removal/Installation

To remove the battery from the radio for recharging or replacement, press the release button (see Figure 3.2) and then rotate it upward to the approximate point shown and remove it from the radio.

Figure 3.2 Battery Removal



3.4.2 Low Battery Indication

Note *If the radio contains encryption keys and is not programmed for infinite key retention, be sure to reattach a battery within approximately 30 seconds to prevent the loss of these keys (see following).*

A low-battery condition is indicated by the  icon in the display. The battery should be recharged or replaced as soon after this indication appears. Once this indication appears, it stays on until power is cycled.

The following additional low battery indications and conditions may be enabled by programming:

- A chirp sounds once a minute in the receive standby and transmit modes.
- A chirp sounds each time the PTT switch is pressed.
- The top panel LED indicator flashes red every 30 seconds in the receive mode.
- Low power is selected when transmitting.

As indicated in the preceding note, the radio may need to be connected to a constant power source to preserve the encryption keys in memory. This is required if “infinite key retention” is not programmed. To allow the battery to be changed without losing the keys with this feature disabled, storage capacitors maintain the supply voltage to memory for approximately 30 seconds without a battery attached. Therefore, be sure to reattach a battery within that time. Refer to Section 8 for more information on encryption keys.

There is a battery saver feature that can be enabled by programming. This feature functions on trunked channels, and it automatically selects low transmit power when the receive signal strength (RSSI) indicates that the site is nearby.

3.4.3 Battery Charging

Note *When a battery is charged while attached to the radio, make sure radio power is off (see following).*

The battery can be charged separately or while attached to the radio. When it is charged while attached to the radio, radio power should be turned off. If it is not, the battery begins slowly discharging when the charger enters the trickle charge mode. This mode is indicated by a green Ready indication, and it is entered automatically when the battery is nearly fully charged. Gradual discharging occurs in the trickle mode because the charge current of approximately 50 mA is less than the radio standby current of approximately 200 mA.



Do not transmit in close proximity to the charger base (see following).

Do not expose the charger base to high level RF signals while a battery is being charged because this may cause a charger fuse to blow (especially in the UHF range). Radios programmed for SMARTNET/SmartZone operation, for example, may affiliate while in the charger which causes them to automatically key. Therefore, do not leave radio power on while charging as described above.

3.4.4 Beltclip Installation

Remove the battery and slide the belt clip into the slot on the battery as shown below. To remove the clip, simply slide it out. It is held in place by the chassis when the battery is installed on the radio.

Figure 3.3 Beltclip Installation



3.4.5 Connecting an Accessory

To connect an accessory to the transceiver, proceed as follows:

- 1 Remove the protective cover over the accessory jack on the side of the transceiver.
- 2 Insert the hook on the lower end of the accessory connector into the slot on the side of the transceiver.
- 3 Rotate the latch open, press the connector against the transceiver, and then release the latch to lock the connector in place.

- 4 Install the included locking screw in the latch tab in the location shown.

Figure 3.4 Accessory Connector



3.5 Backlight

The backlight for the display and option keys can be programmed to automatically turn on when any key is pressed. It then automatically turns off after a programmed delay of 0-7.5 seconds so that battery drain is minimized. If the Backlight option switch or menu parameter is programmed, the user can manually turn the backlight on and off (it then stays on). If the Surveillance mode is programmed, the backlight is disabled (see Section 4.8). The radio can be programmed so that the backlight turns on in the keypad lock mode when a key is pressed (see next section).

3.6 Keypad Lock

The Keypad Lock feature temporarily disables the front panel keys to prevent keys from being accidentally pressed. This feature is available if the Keypad Lock option switch is programmed. To lock the keypad, simply press the Keypad Lock option switch. Then to unlock the keypad again, press and hold this switch until a tone sounds (approximately one second).

Permanent Keypad Lockout can also be programmed. The keypad is then permanently disabled and cannot be enabled by the user. Additional information on this feature follows.

- A global “Front Keypad Lockout Only” function can be selected by programming. The front panel keys but not the side panel option keys are then disabled by the preceding

Keypad Lock and Permanent Lock functions. If this function is not selected, both the front and side panel keys are disabled. The PTT switch is never disabled.

- The Channel Selector and Volume controls can be programmed so that they are locked by the Keypad Lock function.
- The “Channel Selector Enabled” function can be programmed globally. If this is not selected, the channel selector is always disabled regardless of the Permanent Lockout or Keypad Lock status. Channels can then be selected only by direct channel select (see Section 3.3).
- The volume control is permanently disabled if a Volume Up/Down option switch is programmed regardless of the Permanent Lockout or Keypad Lock status. Refer to Section 3.1.3 for more information.
- There is the option to enable the backlight when a key is pressed in the Keypad Lock mode. There is also the option when programming conventional channels to disable DTMF dialing.

3.7 Setting Squelch

This radio does not have a squelch control. The squelch level is preset during alignment. If the keypad programming feature is available (see Section 5.15), the squelch level can be changed by the user on each conventional analog channel.

3.8 Transmit Disable

Transmitting can be disabled on each conventional, SMARTNET, SmartZone, and P25 Trunked channel so that the channel is monitor-only. When transmitting is attempted on a receive-only channel, “Rx Only” is displayed and an error tone sounds.

3.9 Radio Operating Modes

Each selectable channel can be programmed for the conventional (analog or APCO Project 25 digital), SMARTNET/SmartZone, or APCO Project 25 digital trunked operating mode. For example, Zone 1/Channel 1 could be a conventional channel, Zone 1/Channel 2 a SMARTNET channel, and so on. More information on these modes follows.

3.9.1 Conventional Mode

This is a non-trunked operating mode which accesses independent radio channels. There is no automatic access to several channels. Selecting a conventional channel selects a transmit and receive frequency and other channel parameters such as squelch control coding.

Conventional channels can be either standard (analog) or Project 25 (digital). With digital operation, the DSP (Digital Signal Processor) converts the audio signal to digital data which is sent over the air as complex tones. Another difference is that analog channels use Call Guard (CTCSS/DCS) squelch control and Project 25 channels use a NAC (Network Access Code) and talk group ID codes.

With Project 25 operation, a NAC is transmitted and it must match the NAC programmed in the base equipment and the radio(s) being called for communication to occur. In addition, to receive standard group calls, the receiving radio must be programmed to detect the transmitted talk group ID code.

With conventional operation, a busy channel condition is detected automatically if the busy channel lockout (transmit disable on busy) feature is programmed. Otherwise, it must be detected manually. An out-of-range condition is not indicated by special tones or messages as with SMARTNET operation because there is no initial data exchange with the repeater that allows this condition to be detected. Operating features unique to conventional channels are described in Section 5.

3.9.2 SMARTNET/SmartZone Mode

This is a trunked operating mode in which automatic access is provided to several RF channels. ID codes are used to select what radios are being called and what calls are received. Monitoring is performed automatically and special messages and tones indicate busy and out-of-range conditions.

SMARTNET and SmartZone operation and programming is very similar. Basically, SMARTNET operation is limited to a single repeater site and SmartZone operation allows automatic roaming between sites. Enhanced SMARTNET/SmartZone features include roaming (SmartZone only), telephone, private, and emergency calls, Call Alert™, and messaging. Either analog or digital signaling may be used (digital is optional).

When a SMARTNET or SmartZone channel is selected or the radio is powered up on one of those channels, it searches for a control channel. Once a control channel is found, the alias (name) of the selected channel is displayed and the radio attempts to register on the radio system. If a control channel could not be found (because of an out of range condition or the system ID is not correct, for example), “No Sys” (early units) or “Out Rnge” (later units) is displayed and the radio continues to search for a control channel.

The control channel transmits and receives system information to and from all radios registered on the system. Therefore, once a control channel is found, it is continuously monitored for incoming call information and is used to make call requests. The radio automatically changes to a traffic channel to place and receive calls and then returns to the control channel when the call is complete. Operating features unique to SMARTNET/SmartZone channels are described in Section 6.

3.9.3 P25 Trunked Mode

The P25 Trunked operating features are very similar to the SmartZone type just described. Since SmartZone features are also similar to SMARTNET features, all three modes are described in the Section 6. Some differences between the P25 Trunking and SmartZone modes are as follows:

- Digital signaling is always used with P25 calls. Either analog or digital signaling may be used for SmartZone calls.
- Calls made to a specific radio in the P25 mode are called Unit Calls. In the SMARTNET/SmartZone mode they are called Private Calls.
- Messaging is not available with P25 calls.
- Telephone calls are available.
- The P25 control channel data rate is 9600 baud and the digital voice data rate is also 9600 baud. With SmartZone operation, the control channel data rate is 3600 baud (both digital and analog calls) and the narrowband digital voice data rate is 9600 baud.
- The P25 mode uses a system ID, Wide Area Communications Network (WACN) ID, and RF Subsystem ID (RFSS). The SmartZone mode does not use the WACN and RFSS IDs.
- P25 Unit IDs can be 1-16,777,215 (000001-FFFFFF hex) and SmartZone Unit IDs can be 1-65,535 (0001-FFFF hex).

3.9.4 Systems, Channels, and Zones

A zone and channel are selected to place and receive calls. The following describes the relationship between systems, channels, and zones.

3.9.4.1 Systems

A system is a collection of channels or talk groups belonging to the same repeater site. It defines all the parameters and protocol information required to access a site. Up to 16 systems of any type can be programmed.

The maximum number of channels assignable to a system is limited to 512. Channels may also be limited by available memory space as described in the following information.

3.9.4.2 Channels

A channel selects a radio (RF) channel or talk group as follows:

Conventional Analog Mode - A channel selects a specific radio channel, Call Guard (CTCSS/DCS) squelch coding, and other parameters unique to that channel.

Conventional Project 25 Mode - A channel selects a specific radio channel, NAC squelch coding, talk group ID, and other parameters unique to that channel.

SMARTNET/SmartZone and Trunked Project 25 Modes - A channel selects a specific talk group, announcement group, emergency group, and other parameters unique to that talk group.

A maximum of up to 512 channels can be programmed with the preceding modes. These channels can belong to a single system or multiple systems. The maximum number is also limited by the available memory. For example, since more memory is required to program a SMARTNET system than a conventional system, the total number of channels decreases as the number of SMARTNET channels increases. The programming software displays a bar graph which shows the amount of available memory space that is used by the current data.

3.9.4.3 Zones

A zone is a collection of up to 16 channels of any type. For example, a zone could include 12 conventional channels and four SMARTNET channels. One use of zones may be to program the channels used for operation in a different geographical areas. The maximum number of zones is 32.

3.10 Radio Tune Test Mode

Radio Tune Test Mode is entered by pressing Side Button 2 during the interval between the initial display and the completion of the self test. Pressing Side Button 2 after the self test has completed has no noticeable effect on the radio other than its programmed functionality. I.e., if Side Button 2 is pressed after the self test has completed, the radio operates normally and Radio Tune Test Mode cannot be entered while the radio remains powered.

After pressing Side Button 2 during the self test, the radio completes the self test and displays the message “Service”. The radio cycles through several informational displays, which are summarized in Table 3.1.

Table 3.1 Initial Messages

5100 ES	Description
Service	Test Tune Mode initial message
Firmware	Firmware display message
V x.y.z	Firmware version number
DSP	DSP display message
V x.y.z	DSP version number
SEM	SEM display message
V x.y	SEM version number
File Form.	File format display message
V x.y	File format version number
Bootload	Bootload display message
V x.y	Bootload version number
ESN	ESN display message
xx-xx-xx-xx-xx-xx-xx-xx*	ESN of the radio (in hexadecimal)
Band	Band display message
[VHF, UHF, UHF High, UHF 380, 700/800, 800, 900]	Band of the radio
* Scrolling Message	

To stop a display, press the **Up** Button. To continue displays, press the **Down** Button. To quickly cycle through the displays, continue to press the **Down** button. You cannot go back to displays that have already been shown.

Upon completion of the information displays, the radio enters a menu mode. The default option is the RF Test Mode, and the message “RF Test” is displayed. Press Side Button 1 to cycle between the two modes, RF Test Mode and the Control Top and Keypad Test Mode (displaying “CH Test”), Press the Emergency Button to enter into the test mode that is currently displayed.

3.10.1 RF Test Mode

In RF Test Mode, the radio has a set number of frequencies and tests that can be run depending on the radio’s band. The frequencies that can be tested are summarized in Table 3.2 and the test environments are summarized in Table 3.3. Press Side Button 2 to advance to a different test channel, and press Side Button 1 to advance to the next test. In this mode, the display shows the current environment and frequency, “SSSSS: x”. SSSSS is the display string as given in Table 3.3, and x is the test channel number assigned in Table 3.2

Table 3.2 summarizes frequencies that can be tested.

Table 3.2 RF Test Mode Frequencies (MHz)

Test Channel	VHF Rx *	VHF Tx *	UHF Rx *	UHF Tx *	700/800 MHz Rx	700/800 MHz Tx
	136.075	136.025	380.075	380.025	764.0625	764.0125
	142.075	142.125	390.075	390.025	769.0625	769.0125
	154.275	154.225	400.075	400.025	775.9375	775.9875
	160.175	160.125	411.075	411.025	851.0625	794.0125
	168.125	168.075	424.975	424.925	860.0625	809.0125
	173.925	173.975	425.075	425.025	869.9375	823.9875
			435.075	435.025	851.0625	851.0125
			445.075	445.025	860.0625	860.0125
			457.075	457.025	869.9375	869.8875
10			469.975	469.925		
* Future band for 5100 ES radios						

Test environments are summarized in Table 3.3.

Table 3.3 RF Test Mode Environments

Display String	Description	Function
ANA	Carrier Squelch	Normal radio operation: Rx – unsquelch if carrier detected Tx – mic audio
CTCSS	Tone Private-Line	CTCSS operation: Rx – unsquelch if carrier and 192.8 Hz tone detected, always show carrier with green LED. Tx – mic audio plus 192.8 Hz tone
DIG	P25 Digital Conventional	Tone operation: (equivalent to high deviation test in PCTune) Rx – none Tx – 1200 Hz tone
MON	Carrier Unsquelch	Monitor operation: Rx – always unsquelch Tx – mic audio

3.10.2 Control Top and Keypad Test Mode

Once Control Top and Keypad Test Mode is selected from the menu, all icons are displayed and the LED lights red. Upon release of the emergency button, the radio is in Control Top and Keypad Mode. In this mode, all of the buttons, switches, and knobs on the radio can be tested to determine if they are operating correctly. Performing any event with the radio results in a tone as well as a display of what action took place. A summary of the displays is included as Table 3.4. If the radio is in Control Top and Keypad Test Mode but no action is taking place, the message “CH Test” continues to display.

Table 3.4 Control Top and Keypad Test Mode Display Messages

Action	Display
Emergency button pressed/released	Emer: 1/Emer: 0
Channel selector switch moved	Chan: x, where x is the current position of the switch
Toggle switch moved	Toggle: x, where x is the current position of the switch
Volume knob turned	Vol: x, where x is the current position of the knob from 0 – 255 (this will vary at the boundaries)
Side button 1 pressed/released	SB1: 1/SB1: 0
Side button 2 pressed/released	SB2: 1/SB2: 0
Side button 3 pressed/released	SB3: 1/SB3: 0
PTT button pressed/released	PTT: 1/PTT: 0
F1 button pressed/released	F1: 1/F1: 0
F2 button pressed/released	F2: 1/F2: 0
F3 button pressed/released	F3: 1/F3: 0
F4 button pressed/released	F4: 1/F4: 0
Up button pressed/released	Up: 1/Up: 0
Down button pressed/released	Down: 1/Down: 0
“1” button pressed/released	Btn 1: 1/Btn 1: 0
“2” button pressed/released	Btn 2: 1/Btn 2: 0
“3” button pressed/released	Btn 3: 1/Btn 3: 0
“4” button pressed/released	Btn 4: 1/Btn 4: 0
“5” button pressed/released	Btn 5: 1/Btn 5: 0
“6” button pressed/released	Btn 6: 1/Btn 6: 0
“7” button pressed/released	Btn 7: 1/Btn 7: 0
“8” button pressed/released	Btn 8: 1/Btn 8: 0
“9” button pressed/released	Btn 9: 1/Btn 9: 0
“0” button pressed/released	Btn 0: 1/Btn 0: 0
“*” button pressed/released	Btn *: 1/Btn *: 0
“#” button pressed/released	Btn #: 1/Btn #: 0

Radio-wide Features

4.1 Option Switches

Most all the buttons on this radio are programmable as follows:

- On the side panel, the three buttons above the PTT switch (see Figure 2.3).
- On the top panel, the rotary three-position switch and the orange button (see Figure 2.2).

Note *For descriptions of the functions controlled by these switches, refer to the section of this manual referenced in the last column of Table 4.1.*

The functions that can be controlled by option switches are shown in Table 4.1. Each option switch can be programmed to control a different function in each of the three operating modes. For example, <F3> can control one function when a conventional channel is selected, another when a SMARTNET/SmartZone channel is selected, and still another when a Project 25 trunked channel is selected.

Table 4.1 Programmable Functions

Function	Function
Alert Tone Volume Adjust	Request To Talk
Audio Mute Toggle	Rw Scan List Edit
Backlight	Scan
Call Alert	Scan List Edit
Channel Select	Scan List Select
Clone	Second Home Channel
Contrast Level Adjust	Security Mode
Display Mode	Set User Password
EMERGENCY	Single Tone Encoder
Home	Status
Home Channel	Surveillance Mode Toggle

Table 4.1 Programmable Functions

Function	Function
Interconnect	Talk Group Select
Keypad Lockout	Tones Toggle
Keypad Programming	Tx Power
Keypad Squelch	Unit Call
Keypress Tone Volume Adjust	Unused Function Index 0f
Key Select	Unused Function Index 10
Menu	Unused Function Index 17
Message	Unused Function Index 1e
Monitor	Unused Function Index 25
Normal Selective Squelch	Unused Function Index 2e
OTAR Hello (PCC Re-Key Request)	Unused Function Index 30
OTAR Keypad Select	Volume Down
Packet Data	Volume Up
Priority Channel	Zeroize
Radio Info	Zone Edit
Radio Wide Scan	Zone Lock
Repeater Talk Around	Zone Select

4.2 Feature Enable/Disable

One of the function buttons may be programmed to enable/disable certain features. These features have binary On/Off states, and the programmed button toggles the feature to the alternate state. Figure 4.2 identifies features that may be enabled or disabled using the programmed button. One short beep indicates the feature is On; Two short beeps indicate the feature is Off.

Table 4.2 Features which May Be Enabled/Disabled using the Function Button

Function	Conventional	SMARTNET/ SmartZone	P25 Trunking
Alert Tones	x	x	x
Backlight	x	x	x
Clear / Secure	x	x	x
High / Low Power	x	x	x
Keypad Lock	x	x	x
Monitor	x		
Mute / Unmute	x	x	x
Radio Wide Scan	x	x	x
Repeater Talk Around	x		

Table 4.2 Features which May Be Enabled/Disabled using the Function Button

Function	Conventional	SMARTNET/ SmartZone	P25 Trunking
Scan	X	X	X
Selective Squelch (ON) / Normal Squelch (OFF)	X		
Site Lock		X	X
Surveillance Mode	X	X	X
Zone Lock	X	X	X

4.3 Menu Mode

Note For descriptions of the functions controlled by the menu mode parameters, refer to the section of this manual referenced in the last column of Table 4.1.

Most functions that can be controlled by an option switch can also be controlled by the menu mode. The functions that can be controlled by the menu mode are shown in Table 4.1. Functions can be controlled by both an option switch and a menu parameter if desired.

When the menu mode is used, the <F1> and <F2> switches become dedicated menu mode control switches (see following illustration). The <F1> switch is Back/Clear, and the <F2> switch is Menu Select/Enter. If the menu mode is disabled, these switches can be programmed for other functions.

Figure 4.1 Menu Mode Buttons

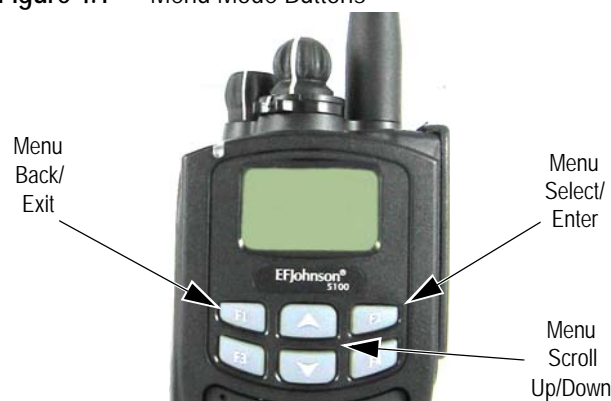

Only the enabled menu items which apply to the selected channel type are displayed. For example, if a conventional channel is selected, only the enabled functions for conventional channels are displayed.

When in the menu mode, messages continue to be received on the selected channel. However, the display does not indicate who is calling. Pressing the PTT switch exits the menu mode and keys the transmitter.

The menu mode operates as follows:

- 1 To select the menu mode, press the <F2> key. Up to three menu parameters are then displayed as shown in the preceding illustration.
- 2 To scroll up or down through the menu parameter list, press the Up/Down switch. The selected parameter is indicated by a dark bar.
- 3 To display the available modes for a highlighted parameter, press the <F2> switch. The currently selected mode is indicated by an asterisk.
- 4 Press the Up/Down switch to highlight the desired mode. Then press the <F2> key to select that mode.
- 5 To step back to the previous level or exit the menu mode, press the <F1> (Back) key.

4.4 Time-Out Timer

The time-out timer disables the transmitter if it is keyed continuously for longer than the programmed time. It can be programmed for 15-225 seconds or it can be disabled by programming 0 seconds.

If the transmitter is keyed for longer than the programmed time, the transmitter is disabled, a continuous tone sounds, and “TX Timeout” is displayed. Five seconds before time-out occurs, a warning beep sounds to indicate that time-out is approaching. The timer and tone are reset by releasing the PTT switch.

A different time can be programmed for each system, and the timer can be enabled or disabled on each conventional channel. With conventional channels, a penalty time may also be programmed that prevents transmissions for a certain time after the transmitter is disabled (see Section 5.5).

One use of this feature is to prevent a channel from being kept busy for an extended period by an accidentally keyed transmitter. It can also prevent possible transmitter damage caused by transmitting for an excessively long period.

4.5 Home Zone/Channel Select

If the Home Zone option switch or menu parameter is programmed, it selects the pre programmed home zone. The selected channel is displayed if the channel switch is enabled, and the pre programmed home channel is selected if it is disabled. A secondary Home Zone, Home2, may also be programmed.

Pressing and holding the Home Zone option switch until a tone sounds makes the currently selected zone the new Home zone. The radio is also programmed so that either the home or last selected zone is selected when power is turned on. Refer to Section 3.3 for more information.

4.6 Power Output Select

Each conventional channel and SMARTNET/SmartZone and P25 Trunked system can be programmed for high, low, or switchable power. If the High/Low Power option switch or menu parameter is programmed and selectable power is programmed on the current channel or system, high and low transmitter power can be selected. All models support high and low power. The low power level is typically 1 watt and the high power level the rated power output of the radio (2.5 - 5 watts, depending on frequency band).

The new level is flashed in the display as either “Hi Power” or “Low Power”. If selectable power is not permitted on the current channel, “Fixed Low” or “Fixed High” is flashed and no change occurs. The selected power level for a channel or system is permanent until it is manually changed again. The low power mode may be automatically selected during a low battery condition (see Section 3.4.2).

4.7 Alert Tone Select

The various alert tones that sound are described in Section 7.1. These tones can be turned on and off if the Alert Tone option switch or Tones menu parameter is programmed. When all tones are off, “Tone Off” is momentarily displayed, and when all tones are on, “Tone On” is momentarily displayed. If this switch or menu parameter is not programmed, tones are fixed in the on or off mode by programming. If the Surveillance mode is programmed (see following), tones are totally disabled.

The Alert Tone volume can be adjusted relative to the volume control setting. This is done by programming and also by the user if the Tone Volume Adjust option button or menu parameter is programmed. Relative levels of -170 to +170 can be set with “0” the default setting. A minus value decreases the tone volume and a plus value increases it. The user adjusted level permanently overrides the programmed level if applicable.

4.8 Surveillance Mode

The Surveillance mode totally disables the backlight, all alert tones, and front panel LED indicator in all operating modes. The radio can be fixed in this mode by programming or it can be turned on and off by the user if the Surveillance Mode option button or menu parameter is programmed. The user selected mode permanently overrides the programmed mode if applicable. To provide a transmit indication when the front panel LED is disabled, the  icon is displayed (see Section 2.4). This icon is displayed only in the surveillance mode.

4.9 Scanning



Scanning monitors the channels in the scan list for messages that the radio is programmed to receive. When a message is detected, scanning stops and the message is received. Shortly after the message is complete, scanning resumes (unless it has been disabled). When a call is received in the scan mode, the alias of the channel on which a call is received (and any other display parameters that may be programmed) are displayed until scanning resumes. The selected channel alias is then displayed if applicable.

There are two basic scan modes available: Priority (Standard) and Radio Wide. The operation of the priority type is unique to the type of channel selected, and the operation of Radio Wide type is the same regardless of the type of channel selected. Only one type can be enabled at a time. For example, if priority scanning is enabled and radio wide scanning is selected, priority scanning is automatically disabled and vice versa. More information on these types of scanning follows.

4.9.1 Priority Scanning

Priority scanning (also referred to as standard scan) monitors only channels that are the same type as that currently selected. For example, if a conventional channel is selected, only conventional channels are scanned and likewise for SMARTNET/SmartZone and Project 25 Trunked channels.

More information on how priority scanning operates in the Conventional Mode is located in Section 5.10, and for the other modes in Section 6.11. Priority scanning is turned on and off by the Scan option switch or menu parameter as follows. If this switch or menu parameter is not programmed, Priority scanning is not available.

- Enable scanning using the Scan option switch or menu parameter. Scanning is enabled when “Scan On” is briefly displayed and the  icon is indicated.
- To turn scanning off, press the Scan option switch again or select “Off” in the scan menu. Scanning is disabled when “Scan Off” is briefly displayed and the  icon is no longer indicated.

- If the zone or channel is changed while scanning is selected, scanning continues on the same or a different scan list (see Section 4.10.1).

Note *Each SMARTNET/SmartZone and P25 trunked channel can be programmed so that scanning is automatically enabled when the channel is selected.*

4.9.2 Radio Wide Scanning

Note *Use radio wide scanning only if two different channel types need to be scanned at the same time such as conventional and SMARTNET/SmartZone. Otherwise, use the more efficient priority scanning because there is less chance of missed calls.*

Radio wide scanning monitors the channels in the pre programmed radio-wide scan list. This scan list can include up to 16 channels of any type and assigned to any zone (see Section 4.10.2). Radio wide scanning is turned on and off by the Radio Wide Scan option switch or menu parameter as follows. If this switch or menu parameter is not programmed, radio wide scanning is not available.

- Enable Radio Wide Scanning using the Radio Wide Scan option switch or menu parameter. Radio wide scanning is enabled when “RW Scn On” is briefly displayed and the **Z** icon is indicated.
- To turn radio wide scanning off, press the Radio Wide Scan option switch again or select “Off” in the menu. Scanning is disabled when “RW Scn Off” is briefly displayed and the **Z** icon is no longer indicated.
- If the zone or channel is changed while radio wide scanning, scanning continues normally.

4.9.3 Scan Hold Time

When a message is received or transmitted while scanning, there is a delay before scanning resumes. The delay after receiving a call prevents another message from being received before a response can be made. The delay after transmitting ensures that a response is heard instead of another message occurring on some other channel.

Separate delay times are programmable for Radio Wide and Priority scanning. With radio wide and conventional priority scanning, delays of 0-7.5 seconds are programmable in 0.5-second steps. With SMARTNET/SmartZone and P25 Trunked priority scanning, a scan delay of 2-10 seconds can be programmed in 0.5-second steps. The radio wide time is programmed on the Radio Wide screen and the Priority time is programmed on the applicable Per System screen.

4.9.4 Transmitting in the Scan Mode

4.9.4.1 Priority Scan Mode:

When the transmitter is keyed while scanning is enabled, the transmission may occur on various channels as follows.

Conventional Operation - Transmissions can be programmed to always occur on the priority, selected, or receive channel (if applicable). Refer to Section 5.10 for more information.

SMARTNET/SmartZone/P25 Trunked Operation - If scanning is halted to receive a message, programming determines if transmissions occur on the selected or active channel. Transmissions at other times occur on the selected channel.

4.9.4.2 Radio Wide Scan Mode:

The radio can be programmed to transmit on the selected or active channel similar to SMARTNET/SmartZone and P25 trunked operation just described.

4.9.5 Nuisance Channel Add/Delete

With priority scanning, channels can be temporarily deleted from the scan list, for example, if messages become annoying. This feature is not available with radio wide scanning. Channels can also be permanently added or deleted from a scan list as described in the next sections. Use the following steps to temporarily delete a nuisance channel:

Note *The selected channel and also priority channels cannot be deleted from the scan list.*

- 1 While receiving a message on the channel to be deleted, press and hold the Scan option switch until a tone sounds (about one second).
- 2 The channel is deleted and scanning of the remaining channels in the scan list resumes.
- 3 Deleted channels are added back into the scan list if any of the following occur:
 - Scanning is turned off and then on again using the Scan option switch or menu parameter.
 - Radio power is turned off and then on again.

The selected channel is changed.

4.10 Scan Lists

4.10.1 Priority Scan Lists

Note *The selected channel is always scanned.*

A scan list is simply the channels that are scanned when scanning is enabled. With all operating modes, as many priority scan lists as are required can usually be programmed (up to 256). The only limitation is the available memory. Each scan list can include up to 512 channels/talk groups. More information on selecting and editing priority scan lists follows.

4.10.1.1 Determining Channels in Priority Scan List

The channels in conventional priority scan lists are indicated by selecting the scan mode as follows. Channels in SMARTNET/SmartZone/P25 Trunked priority scan lists are indicated only when editing a scan list (see “Editing a Priority Scan List” which follows).

- 1 Enable priority scanning using the Scan switch or menu parameter. Also select the scan list if applicable as described in the following “Selecting a Priority Scan List” description.
- 2 Select the desired zone and then scroll through the channels by rotating the channel switch. When the displayed channel is in the scan list (scanned normally), the  icon is displayed.

4.10.1.2 Selecting a Priority Scan List

Note *Only priority scan lists are selectable.*

Conventional Channels - Conventional systems are programmed with a default scan list that is normally selected by all channels in that system. However, there is a programmable option to slave a particular conventional scan list to a zone. This then becomes the default list for all conventional channels in that zone (it overrides the system programming). This slave feature is programmed on the Edit Zone screen.

If the Scan (List) Select option switch or menu parameter is programmed, the default list selected by all conventional channels (even those belonging to slaved zones) is temporarily changed. The preceding default scan lists are automatically reselected whenever radio power is cycled.

SMARTNET/SmartZone and Project 25 Trunked Channels - Each channel (talk group) can be programmed so that one of the programmed lists is selected or scanning is disabled (No List). In addition, channels can be programmed so that scanning is automatically enabled (Auto Scan) when they are selected.



If the Scan (List) Select option switch or menu parameter is programmed, the list that is selected by all talk and announcement groups in the current system can be temporarily changed by the user as follows. “No List” (scanning disabled) or “Programmed” (default list) can also be selected if desired. The programmed default scan list is automatically reselected on power up.

To change the currently selected scan list (all channel types), proceed as follows:

- 1 With scanning disabled ( icon not displayed), press the Scan List option switch or select the Scan Select menu parameter.
- 2 The currently selected list is displayed as “List x”, where “x” is the currently selected list. To exit without changing the selected list, simply press the Scan List option switch again or the <F1> key.
- 3 To select another list, press the Up/Down switch. When the desired list is displayed, select it and exit this mode by pressing the Scan List option switch again or the <F1> or <F2> key.

4.10.1.3 Editing a Priority Scan List

If the Scan Edit option switch or menu parameter is programmed, conventional, SMARTNET/SmartZone, and P25 Trunked priority (standard) scan lists can be user programmed. Changes are permanent (cycling power does not reselect a default condition). Proceed as follows:

- 1 Make sure that both priority and radio wide scanning are off ( icon not displayed). Select a conventional or SMARTNET/SmartZone/P25 Trunked channel corresponding to the scan list being programmed.
- 2 Select the scan edit mode using the Scan Edit option switch or menu parameter. This mode is indicated by  in the display.
- 3 If applicable, select the list to be edited by pressing the Up/Down switch. Select the desired list by pressing the <F2> key. The selected list is indicated as “List x”. If user programming is disabled on a list, (conventional only) “No Edit” is momentarily displayed and it cannot be edited.
- 4 Select the channel you want to add or delete by pressing the Up/Down switch. After the last channel in the current zone is displayed, the first valid channel in the next zone is displayed and vice versa. Lists are limited to 512. If an attempt is made to add more than 512, “List Full” is displayed and a channel must be deleted before another can be added.

Note *Priority channels can be deleted.*

- 5 If the selected channel is in the scan list (scanned), the  icon is displayed. To change the status of the displayed channel, press the <F2> (Enter) switch.
 With conventional channels only, if the selected scan list is programmed with fixed priority channel(s), the next press of <F2> makes the current channel the priority channel indicated by **P**. If dual priority channels are used, pressing <F2> again makes it the second priority channel indicated by **P₂**. Then pressing <F2> again takes the channel out of the scan list. Refer to Sections 5.10.2 and 6.11.1 for more information on priority channel sampling.
- 6 To exit this mode and save the changes, press the <F1> (Exit) key or the Scan Edit option switch again.

4.10.2 Radio Wide Scan Lists



With radio wide scanning, there is only one scan list available regardless of the type of channel selected. This list is user programmable, and can contain up to 16 channels of any type. For example, it could include six conventional channels and ten SMARTNET/SmartZone channels. More information on selecting and editing radio wide scan lists follows.

4.10.2.1 Determining Channels in Radio Wide Scan List

The channels in model radio wide scan lists are determined by selecting the scan list edit mode (see “Editing Radio Wide Scan List” which follows). When the displayed channel is in the radio wide scan list (scanned normally), the  icon is displayed.

4.10.2.2 Editing a Radio Wide Scan List

If the RWS Edit option switch or menu parameter is programmed, the radio wide scan list can be edited. Changes are permanent (cycling power does not reselect a default condition). Proceed as follows:

- 1 Make sure that both priority and radio wide scanning are off ( icon not displayed). Select the scan edit mode using the RWS Edit option switch or menu parameter. This mode is indicated by  in the display.
- 2 Select the channel you want to add or delete by pressing the Up/Down switch. After the last channel in the current zone is displayed, the first valid channel in the next zone is displayed and vice versa. Lists are limited to 16 channels. If an attempt is made to add more than 16, “List Full” is displayed and a channel must be deleted before another can be added.

Radio-wide Features

- 3 If the selected channel is in the scan list (scanned), the  icon is displayed. To change the status of the displayed channel, press the <F2> (Enter) switch.
- 4 To exit this mode and save the changes, press the <F1> (Exit) key or the RWS Edit option switch again.

Conventional Mode Features

An overview of the conventional operating mode is located in Section 3.9.1. The following information describes the features unique to analog and digital (Project 25) conventional operation. Refer to the preceding “Radio Wide Features” (Section 4) for information on features common to all operating modes.

5.1 Monitoring Before Transmitting

With conventional operation, you may need to manually monitor the channel before transmitting to make sure that it is not being used by someone else. If you transmit while someone else is using the channel, you will disrupt their conversation. With SMARTNET/SmartZone and P25 Trunked operation, monitoring is performed automatically. You can monitor conventional channels automatically or manually.

5.1.1 Automatic Channel Monitoring

If the selected channel is programmed for Busy Channel Lockout (also called Transmit Disable On Busy), monitoring is automatic. Refer to Section 5.3 for more information on this feature.

5.1.2 Manual Channel Monitoring

The automatic monitoring just described may occasionally disable the transmitter when the channel is not in use, such as if the repeater has extended hang time. In this case, you may not want to use automatic monitoring, but monitor the channel manually as follows:

Busy Indicator - With scanning disabled, note if the multi-function indicator on the front panel is steady green. If it is not, the channel is not being used and a call can be transmitted. If it is green, a carrier is being detected, so the channel may be busy (see following).

Monitor Mode - There may be times when a busy condition is indicated even though no one is using the channel. Monitoring should then be performed by disabling Call Guard squelch (or group ID detect on Project 25 channels). This is usually done by selecting the Monitor Mode (see following) or by the Normal/Selective option switch or menu parameter (see Section 5.4.4).

5.2 Monitor Mode

The monitor mode unsquelches the receiver and monitors the channel even if a carrier is not detected. Other features of this mode are as follows:

- Call Guard (CTCSS/DCS) squelch is disabled on analog channels and NAC and group ID detect are disabled on P25 (conventional) channels.
- Busy Channel Lockout is overridden (see next section)
- Scanning temporarily halts

The Monitor Mode operates as follows:

- 1 To monitor the transmit frequency for activity before transmitting, briefly press the Monitor option switch or select the Monitor menu “Tx Channel” parameter. The  icon is then displayed to indicate the monitor mode and the receiver unsquelches.
- 2 To monitor the receive frequency instead, press and hold the Monitor option switch until a tone sounds or approximately two seconds, or select the Monitor menu “Sqlch Ovrđ” parameter. This can be used, for example, to improve reception if intermittent squelching is making a weak message difficult to understand.
- 3 To disable the monitor mode and return to normal operation, press the Monitor option switch again or select the Monitor menu “Off” parameter.

The Normal/Selective function disables Call Guard squelch and P25 group ID detect but not scanning and P25 NAC detect (see Section 5.4.4).

5.3 Busy Channel Lockout

The Busy Channel Lockout feature (also called Transmit Disable on Busy) automatically disables the transmitter if the channel is busy when the PTT switch is pressed. When the transmitter is disabled by this feature, “Busy” is displayed, a busy tone sounds, and the transmitter is disabled.

The Busy Channel Lockout feature can be programmed to operate as follows. Each conventional channel can be programmed differently.

“Off” - Busy channel lockout is disabled and the transmitter keys even if the channel is busy.

“Noise” - If a carrier is detected on the channel, the transmitter is disabled when the PTT switch is pressed.

“Tone (NAC)” - If an incorrect Call Guard (CTCSS/DCS) or NAC code (see Section 5.14) is detected, the transmitter is disabled when the PTT switch is pressed. An incorrect code is any code other than the one programmed for the current channel.

“Status (P25 Conv Only)” – Radio will monitor the outgoing status symbols of the repeater tx channel. The radio is allowed to transmit if the idle symbol is detected.

If Busy Channel Override is permitted by programming, it is possible to transmit even when the transmitter is disabled by this feature. Simply release the PTT switch and then quickly press it again.

5.4 Call Guard Squelch

Tone or digital Call Guard squelch (also called CTCSS/DCS signaling) can be programmed on each conventional analog transmit and receive channel in any order desired. The reverse burst and turn-off code are always transmitted and also detected on channels programmed with Call Guard squelch.

The Call Guard squelch feature eliminates distracting messages intended for others using the channel. This is done by using a subaudible tone or digital code to control the squelch. This tone or code is unique to a user or a group on that channel. This tone or code is transmitted with the voice signal but is not heard because it is in the subaudible range and is attenuated by a filter. Call Guard squelch must be used in both the transmitting and receiving radio to be functional.

5.4.1 Call Guard Squelch Enable/Disable

The Normal/Selective option switch or menu parameter (if programmed) can be used to disable receive Call Guard squelch on analog channels or group ID code detection on P25 channels. When selective squelch is disabled, “Sq Normal” is flashed in the display, and when it is enabled, “Sq Select” is flashed.

When “Normal” is selected, the receiver unsquelches only if a carrier is detected. Scanning and Project 25 NAC detection are not disabled with this mode selected. The selected mode is in effect until it is manually changed again. Selecting another channel or cycling power does not reselect a default condition. There is a programmable option to display the monitor  icon when the “Normal” mode is selected.

5.4.2 Tone Call Guard Squelch

Tone-type Call Guard squelch utilizes subaudible CTCSS tones from 67-254.1 Hz. Although there are 42 tones assigned, those above 33 (210.7 Hz) are normally not used because of their close proximity to the voice band which starts at 300 Hz. In addition, tones 11 (97.4 Hz), 39 (69.3 Hz), 40 (206.5 Hz), 41 (229.1 Hz), and 42 (254.1 Hz) are normally not used because they may cause interference with adjacent tones.

A reverse burst is transmitted when the push-to-talk switch is released and also detected when calls are received. It is a 180-degree phase reversal for a period of time determined by the tone frequency, and it eliminates the squelch tail (noise burst) in the receiving radio. Both the transmitting and receiving radio must be equipped with this feature for it to be utilized.

If the user would like to hear the squelch tail, then the reverse burst transmission can be disabled by checking the “Disable Squelch Tail Elimination” checkbox.

5.4.3 Digital Call Guard Squelch

Digital Call Guard squelch (DCS) uses digital data instead of subaudible tones to control the squelch. This data consists of continuous repetitions of 23-bit words. No bit or word synchronization information is used. When the push-to-talk switch is released, a turn-off code is transmitted which eliminates the squelch tail similar to the reverse burst.

Although there are thousands of possible code combinations with 23 bits, only 83 are unique with the data scheme used. The number specified when the code is programmed is actually a seed for a special algorithm used to generate the 23-bit data word. The data is transmitted at a rate of 134.4 bits per second. Therefore, approximately six words are transmitted each second. When the data is decoded, 23-bit samples are taken and then the bits are rotated to determine if a valid code was received.

5.4.4 Selective Squelch Code Select (CTCSS/DCS/NAC)

Note *Call Guard codes can be permanently reprogrammed by keypad programming described in Section 5.15.*

This feature allows the normal transmit and receive Call Guard (CTCSS/DCS/NAC) programming to be temporarily overridden with a code selected from a pre programmed list. It is available if the Squelch Select List option switch or menu parameter and a CTCSS/NAC code list have been programmed.

In addition, conventional systems can be programmed for the Keypad CTCSS/DSC feature. Codes can then be selected directly from the table by pressing the key for the code. For example, to select code 3 from the table, simply press the “3” key. No other conventional mode functions can then be assigned to these keys.

The CTCSS/DCS/NAC list is programmed with up to 64 tone (CTCSS) or digital (DCS) Call Guard codes. Different codes can be programmed for the transmit and receive modes, and carrier squelch (selective squelch disabled) can be programmed if desired. In addition, each position can be programmed with an NAC code for use with P25 operation.

When the Call Guard code is changed using this feature, it remains selected even if other channels are selected. However, if radio power is cycled or a talk-around channel is selected, the normal codes are reselected. When scanning, the selected code also applies to all scanned channels. Each channel can also be programmed to always ignore the code selected from this list and use the default code instead.

If both analog and digital (Project 25) channels can be selected or scanned, the CTCSS/DCS code for the selected position is used for analog channels and the NAC code for the selected position is used for P25 channels. If a channel is programmed for mixed mode operation, the selective squelch type (analog or digital) programmed for the transmit mode determines the selective squelch type used.

Proceed as follows to select a code using the Squelch Select List option button or menu parameter:

- 1 Press the Squelch Select List option switch or select the Squelch Code menu mode parameter. Then press the Up/Down switch to select the desired code. The display indicates “SEL SQ xx” where, “xx” is the selected code from 1-64. The code number and actual code are alternately displayed (NACs are displayed in hexadecimal).
- 2 To select the displayed code and return to the normal display, press the <F2> (Select) key or the Squelch Select List switch again.
- 3 To check which code is selected, press the Squelch Select List switch once to display the current selection and then again to return to normal operation.
- 4 To return to the normal selective squelch codes, select “Default” in this mode. As previously described, the normal codes are also automatically reselected whenever radio power is cycled or a talk-around channel is selected.

5.5 Penalty Timer

A penalty timer may be programmed on conventional systems to prevent transmissions for the programmed time after the time-out timer disables the transmitter (see Section 4.4). The penalty timer can be programmed for the same times as the time-out timer, and timing starts when the PTT switch is released. If the PTT switch is pressed during the penalty time, the time-out indication occurs again and the transmitter remains disabled. When the penalty timer expires, a beep sounds and the transmitter can be keyed.

5.6 Conversation Timer

A conversation timer can be programmed on conventional systems in addition to the time-out timer (see Section 4.4). This timer limits the total length of a conversation rather than just the length of each transmission as with the time-out timer. The following is more information on this timer.

- It can be programmed for times up to 7.5 minutes.
- It is reset when the time between transmissions exceeds the time programmed for the penalty timer.
- A warning beep sounds five seconds before this timer disables the transmitter.
- When this timer disables the transmitter, a continuous tone sounds and the red transmit indicator turns off. The PTT switch must then be released until the penalty timer expires (indicated by a beep).

5.7 Repeater Talkaround

Normally, all transmissions go through a repeater which usually increases range. However, there may be times when a user is out of range of the repeater and therefore unable to talk to anyone even though the user being called is only a short distance away. To allow communication in this situation, repeater talk-around can be selected. Transmissions then occur on the receive frequency which permits direct radio-to-radio communication.

Repeater talkaround can be selected if the RTA option switch or menu parameter is programmed. When talk-around is enabled by this switch, **T_A** is displayed. This feature remains enabled during scanning, and changing channels or turning power off does not change the selected condition. Talkaround is available on conventional channels only, and power output is reduced in this mode.

In the PC Configure **Radio Wide** screen, you can program one of the function buttons to the “Repeater Talkaround” function. With a button programmed as “Repeater Talkaround”, the user can press this button while on any conventional frequency, shifting the radio from operation through a repeater, to simplex operation on the repeater transmit frequency.

With a “Repeater Talkaround” button enabled, there is no restriction as to which channels the user can transmit (in simplex mode) on the repeater transmit frequency. A user can switch to talkaround mode on a busy dispatch channel, and his transmissions could prevent nearby users from hearing the repeater transmissions.

5.8 Displaying Transmit/Receive Frequency

If the Displayed Information option switch or menu parameter is programmed (see Section 4.1), it can be used to display the channel frequency in megahertz. Pressing this switch toggles between displaying the standard channel alias and the channel frequency. The receive frequency is displayed when receiving and the transmit frequency is displayed when transmitting. This feature is available on conventional channels only.

5.9 Emergency Alarm and Call

Emergency Alarms and Calls are separate functions that can be individually enabled or disabled on each analog and P25 conventional system. The Emergency option switch or menu parameter is required for these functions. Emergency Alarms and Calls are transmitted on the global (radio wide) emergency zone/channel if one is programmed. If it is not programmed, the emergency is transmitted on the selected channel. The emergency programming of the system to which that channel is linked controls the emergency operation.

5.9.1 Emergency Alarms

An emergency alarm is a special transmission that alerts a dispatcher of an emergency situation. It is sent automatically by pressing the Emergency option switch or selecting the Emergency menu parameter. The system to which the emergency channel is linked must have Emergency Alarms enabled.

In the P25 conventional mode, a special P25 emergency data transmission is sent, and in the conventional analog mode, an DTMF emergency ID is sent. This ID is programmed on the Conventional **Per System** screen. Refer to Section 5.12.3 for information on MDC1200 Emergency Alert.

For an Emergency Alarm:

- The DTMF Emergency ID is sent.
- The MDC ID is sent with the emergency bit set.
- The Five Tone ID is sent with the fifth tone being status type emergency.
- No special action is done with the single tone.

Proceed as follows to send an emergency alarm:

- 1 If required, select a channel of a system on which Emergency Alarms are enabled and then press the Emergency option switch or select that menu parameter. The radio then automatically transmits the emergency alarm.
- 2 Either Normal or Silent operation can be programmed. With Normal operation, the red LED lights, the emergency tone sounds, and “EMERGENCY” flashes in the display. “EMERGENCY” continues to flash until the alarm ends. If “Silent” is programmed, none of these indications occur. If “No Receive Activity During Emergency” is programmed, receive audio, the front panel LED, and receive icons are disabled in the receive mode.

- 3 When the emergency alarm is acknowledged by the dispatcher, “Ack Rcvd” is briefly displayed and the emergency acknowledge tone (two beeps) sounds. This alert tone can be disabled if desired, and does not occur if Silent operation is programmed.

Retries will only occur for P25 Conventional and MDC as these are the two types of signaling where radios have the ability to decode a systems response.

- 4 The emergency alarm mode is exited when radio power is cycled or by pressing and holding* the Emergency option switch.

5.9.2 Emergency Calls

The Emergency Call feature allows a user to place an emergency voice call by pressing the PTT switch after pressing the Emergency option button or selecting the Emergency menu parameter. If the Emergency Hot Mic feature is enabled, the emergency call is automatically transmitted without having to press the PTT switch (see following description). The system to which the emergency channel is linked must have Emergency Calls enabled. Analog and Digital (P25) calls can be individually enabled.

If the emergency call is sent on a P25 channel, an emergency indication is sent according to the P25 standard (the emergency bit is set in the Common Air Interface). If it is sent on an analog channel, the DTMF Emergency ID is sent in place of the ANI DTMF PTT ID if applicable.

Note *The DTMF Emergency ID is sent only if pre- or post- DTMF ANI is enabled on the channel by programming.*

MDC, Five Tone Signaling, or Single Tone Signaling are sent for Analog Emergency Calls, depending on the setting of the Emergency Analog Signaling field in PC Configure.

5.9.2.1 Emergency Hot Mic

If Emergency Hot Mic has been enabled for emergency calls, automatic transmitting occurs with microphone audio unmuted without having to manually press the PTT switch. The automatic transmit period is programmed for 10-120 seconds in 10-second steps. If this feature or emergency calls are not enabled by programming, automatic transmitting does not occur. This feature is initiated only on the first press of the Emergency switch. Subsequent presses do not trigger automatic transmissions. To reset this function, the channel must be changed or power cycled.

5.9.2.2 Placing an Emergency Call

- 1 If required, select a channel of a system on which Emergency Calls are enabled and press the Emergency option switch or select that menu parameter. The Emergency Alarm is then sent as described in Section 5.9.1 if applicable.
- 2 If the preceding Emergency Hot Mic feature is enabled, the call is automatically transmitted without pressing the PTT switch. If it is disabled, press the PTT switch and begin speaking as with a standard call. If the channel is changed, operation continues on the new channel in the emergency mode.
- 3 With analog calls, subsequent presses of the PTT switch cause the DTMF emergency ID to be sent according to the ANI programming (if DTMF ANI is enabled on the channel). With digital calls, the calls continue to have the emergency bit set.
- 4 If the Surveillance Mode is enabled (see Section 4.8), all indicators, lights, and tones are disabled. If “No Receive Activity During Emergency” is programmed, receive audio, the front panel LED, and receive icons are disabled in the receive mode.
- 5 To exit this mode, cycle radio power or press and hold the Emergency switch.

5.9.3 External Emergency Switch

5100 ES radio models support the External Emergency feature. A special man-down switch (currently available only from third-party vendors) is attached to the accessory connector of the radio. Then if this feature is enabled by programming and the radio is in a horizontal position for longer than the programmed time (0-63 seconds), an emergency condition is triggered the same as if the Emergency switch was pressed. The emergency can be canceled by a press and release of the Emergency switch.

Note *Accessories, such as speaker-microphones, cannot be used with this feature.*

5.10 Conventional Mode Scanning

Channel scanning features common to all operating modes are described in Sections 4.9 and 4.10. The following information describes features unique to conventional operation.

5.10.1 Transmitting in Scan Mode

Each conventional scan list can be programmed for one of the following modes. These modes determine if priority sampling occurs and also the channel on which transmissions occur while scanning. Refer to the next section for more information on priority sampling.

No Priority - No priority channel sampling occurs when the list is selected. The radio transmits on the selected channel.

Priority/Tx Selected - Priority sampling occurs and the priority channel or channels are those programmed in the selected scan list. The radio transmits on the selected channel.

Priority/Tx Priority (1) - Priority sampling occurs and the priority channel or channels are those programmed in the selected scan list. The radio transmits on the priority (1) channel.

Priority (1) on Selected - The priority (1) channel is always the selected channel. The radio transmits on the selected channel.

Talkback - No priority sampling occurs. The radio transmits on the channel of a call while scanning is halted. Then once scanning resumes, it transmits on the selected channel.

5.10.2 Priority Channel Sampling

Note *The following describes priority sampling when scanning conventional channels. Priority sampling when scanning SMARTNET/SmartZone/P25 Trunked channels is described in Section 6.11.*

The priority channel sampling feature ensures that when priority scanning, messages on the priority channel are not missed while listening to a message on some other channel. The radio can be programmed as just described so that the priority channel is a fixed channel programmed in the current scan list, the currently selected channel, or not used.

Note *Priority channel sampling is not available when receiving analog encrypted (DES) calls, nor when receiving unit calls. In addition, the priority channel is not scanned if the active channel is an analog channel on the same frequency as the priority channel and is programmed with CTCSS/DCS squelch control.*

Either a single or dual priority channels can be programmed if desired. With dual priority, a call on the second priority channel is interrupted by a call on the first priority channel but not vice versa. When scanning and the selected channel is a single or first priority channel, **F** is indicated in the display. This indication is displayed regardless of whether the priority channel is fixed or always the selected channel. When it is a second priority channel, **F₂** is displayed.

The priority channel sampling frequency is determined by the programmed Priority Lookback Time A (see description which follows). For example, if 2.0 seconds is programmed, the priority channel is sampled every 2.0 seconds when listening to a message on a non-priority channel. When not listening to a message, the priority channels are scanned in the normal scan sequence. With dual priority, the first and second priority channels are alternately sampled at the Lookback Time.

Priority channel sampling occurs only with conventional priority scanning. It does not occur with radio wide scanning, when listening to any type of SMARTNET/SmartZone/P25 trunked call, encrypted call, or when transmitting (see preceding note). A series of “ticks” may be heard when the priority channel is sampled while listening to a message on some other conventional channel.

The priority sampling times are programmed by the following parameters:

Lookback Time A - This time determines how often the priority channel is checked for activity. Times of 0.25-4.00 seconds in 0.25-second steps can be programmed.

Lookback Time B - This time determines how often the priority channel is checked once an incorrect Call Guard (CTCSS/DCS) or NAC code is detected. Since it takes much longer to detect an incorrect Call Guard signal than a carrier, this time should be relatively long to prevent the interruptions from making a message difficult to understand. Times of 0.5-8.0 seconds can be programmed in 0.5-second steps.

5.10.2.1 Changing the Priority Channel

If a fixed priority channel is associated with the current scan list, it can be changed if the Priority option switch or menu parameter is programmed. With dual priority, this function changes only the first priority channel. To change both priority channels, use the Scan List Edit function described in Section 4.10.1.

Proceed as follows to change the priority channel using the Priority option switch/menu parameter:

- 1 Make sure scanning is disabled (**Z** icon not displayed) and the desired scan list is selected (see Section 4.10).
- 2 Select the channel you want to be the priority channel and then press the Priority option switch or select that menu parameter. “Priority” is then flashed to indicate that the current channel is now the priority channel when scanning that list. Other indications that may occur are as follows:
 - If “No Priority” is displayed, priority sampling may not be enabled on the scan list.

- If “Sel Chan” is displayed, the priority channel is always the selected channel and cannot be changed.
- If no indication displayed, the scan list may not be user editable or the channel may not be in the scan list.

5.11 Standard Conventional Calls

Standard conventional calls are placed to other radio units monitoring the selected channel. The proper coded Call Guard squelch tone or code or P25 NAC may need to be transmitted by your radio for them to receive a call (see Sections 5.4 and 5.14.3).

5.11.1 Placing a Standard Conventional Call

- 1 Turn power on and set the volume as described in Section 3.1. Select the channel programmed for the radio you want to call as described in Section 3.3.
- 2 Monitor the channel automatically or manually as described in Section 5.1.
- 3 Press the PTT switch and if the Busy Channel Lockout feature is programmed on the channel (see Section 5.3), the transmitter is automatically disabled if the channel is busy. Otherwise, busy and out-of-range conditions are not indicated.
- 4 Press (and hold) the PTT switch to talk and release it to listen.

5.11.2 Receiving a Standard Conventional Call

- 1 Select or scan the channel programmed for the call you want to receive (refer to Sections 4.9 and 4.10 for more scanning information).
- 2 When the call is received, press the PTT switch to talk and release it to listen. If scanning, responses may occur on the priority, selected, or receive channel as described in Section 5.10.1.

5.12 ANI Signaling Options

Four types of analog signaling are offered:

- Single Tone Encoding
- Five Tone Encoding
- DTMF

- MDC

Three features use analog signaling:

- Pre and Post ANI
- Emergency Alarm
- RTT

5.12.1 DTMF/ANI Signaling

DTMF (Dual Tone Multi-Frequency) tones can be generated for ANI (Automatic Number Identification) and other purposes on conventional analog channels. One of the following options may be enabled on each channel:

Pre-Tx ANI - A pre programmed ANI sequence is automatically sent each time the PTT switch is pressed.

Post-Tx ANI - A pre programmed ANI sequence is automatically sent each time the PTT switch is released.

When an emergency alarm or call is placed, this ANI signaling is replaced by the Emergency DTMF ID (see Section 5.9). Refer to Section 5.12.3 for information on MDC1200 ANI.

5.12.2 Single Tone Encoder

This feature allows the user to transmit a single tone by pressing the Single Tone Encoder option switch or selecting that menu parameter. Each conventional system can be programmed for a tone of 500-2500 Hz in 1 Hz increments with a duration of 0.5-2.5 seconds in 0.1 second increments.

This feature can be activated with a button press or can be used for Pre and Post ANI, Emergency Alarm, or RTT.

5.12.3 MDC1200 Compatibility

MDC1200 is a signaling protocol designed and implemented by Motorola for analog channels only. The following features of this protocol are supported. Either MDC1200 or standard DTMF ANI/Emergency signaling can be programmed on each conventional system.

Note *This feature is hardware dependent and therefore cannot be added to others by upgrading firmware).*

MDC1200 ANI - Both pre and post ANI are supported.

MDC1200 Decode - MDC1200 decode functionality is supported so that the radio can handle the following MDC1200 features:

- Process the system acknowledgement of emergency transmissions – so that the user knows that the emergency has been received
- PTT ID Decode - Display the ID / Alias of a calling radio on all other radios
- Selective Radio Inhibit – Allow the dispatcher to inhibit a radio
- Call Alert – Alert the user to call the dispatcher
- Radio Check – Verify that the unit is within the operating area

MDC1200 Emergency Alarm - The radio continues trying its emergency transmission until the emergency is acknowledged by the system. The radio will retry for the programmed number of retries.

5.12.4 Five-Tone Signaling

A single transmission consists of five separate tones transmitted sequentially with an optional inter-tone pause between tones. If Five-Tone is selected as the RTT type, then Five-tone shall also be used as the signaling type for conventional analog emergencies. The first four tones are used for unit identification and the fifth tone is used for status.

No two adjacent tones shall be the same frequency. When two identical digits follow each other, the second shall be transmitted as the “Repeat” tone.

Five Tone signaling can also be used for Pre Post ANI and Emergency Alarm Signaling. Fifth Tone Status values are:

Tone 1 – Normal Call

Tone 9 – Emergency Call

Tone 2 – Normal Secure Call

Tone 8 – Emergency Secure Call

5.13 Clone Mode

The Clone feature enables one radio to program another with identical information. The PC Configure programming software is not required. Other requirements are as follows:

- The Clone menu parameter must be enabled in the master (sending) radio. This parameter is not required with the slave (receiving) radio.
- The master and slave radios must be identical models (same frequency range and options).

Only zones with conventional analog and P25 channels can be transferred using this function. Any SMARTNET/SmartZone and P25 trunked information is not transferred. In addition, the P25 Unit ID, encryption keys, and the RSI ID and other OTAR information are not transferred. Cloned zones are indicated in the slave radio by an asterisk in the first character position of the zone alias (the first character is replaced by this asterisk).

5.13.1 Wireless Cloning

A new wireless cloning feature is available that allows one radio to program another using an RF link instead of having to be physically connected by a cloning cable. This feature is available on P25 conventional channels only.

The wireless cloning feature utilizes the P25 data functionality of the radio. Therefore, a conventional P25 channel must be programmed in both radios and the slave radio must have been programmed with a P25 Unit ID. In addition, Data Registration must be enabled in both radios. If it is not programmed, “Disabled” is displayed. Radios with wireless cloning capability have a new selection in the cloning menu to select either Clone N (Normal) or Clone W (Wireless). If Wireless is selected, an additional menu is displayed for entering the P25 Unit ID of the destination radio (slave). The Zone/Complete mode is then selected.

5.13.2 Cloning Procedure

- 1 With normal (non-wireless) cloning, connect the master (sending) radio to the slave (receiving) radio using Cloning Cable, Part No. 023-5100-930.
- 2 On the master radio, select the Clone menu parameter and press the <F2> key. If applicable, select either “Clone W” (Wireless) or “Clone N” (Normal). If normal cloning was selected or if this is not selectable, proceed to step 4.
- 3 With wireless cloning, a screen is then displayed for entering the P25 Unit ID of the destination (slave) radio. Enter this ID using the keypad (or the Up/Down keys) and <F2>.
- 4 The clone mode “Zone” or “Complete” is then selected. Select the desired mode. Operation is as follows:

Zone - This mode allows channel information for only the selected zone to be transferred. Information programmed on the **Global**, **Radio Wide**, and **Per System** screens is not changed. A list of the current conventional zones is displayed. Select the desired zone by highlighting it and pressing the <F2> key. A selected zone is indicated by an asterisk (*). Scroll to “OK” and press <F2> to begin the data transfer. The selected zone in the slave radio is overwritten. Previously, multiple zones could be selected and they were appended to those in the slave radio.

Complete - This mode transfers all conventional programming information. This includes information on the **Global**, **Radio Wide**, and **Per System** screens. Simply

highlight “Complete” and press the <F2> key to begin the data transfer. This mode overwrites all this information currently in the slave radio. None of the previous information is retained except for the IDs as described in Section 5.13.

5.14 Project 25 Mode Features

Note *The following features are unique to conventional P25 channels.*

5.14.1 Unit ID Code

Each radio that operates on Project 25 (digital) channels is programmed with an eight-digit unit ID. This ID is unique for each radio and can be any number from 1-16,777,216. When power is turned on with a Project 25 channel selected, this ID is briefly displayed.

5.14.2 Group ID Code

Each Project 25 channel is programmed with a group ID that determines which group of radios will receive the call. A call is received on a channel if a selected or scanned channel is programmed with that ID and the correct NAC is detected (see following). Group IDs can be any number from 0-65,535. Group ID detect can be disabled by the Normal/Selective squelch function described in Section 5.4.1 or the monitor mode described in Section 5.2

5.14.3 Network Access Code

Project 25 conventional channels also use a NAC (Network Access Code) to control which calls are received on a channel. The NAC can be 0-4095, and each transmit and receive channel can be programmed for a different code. Other operation, such as monitoring before transmitting, is similar to that of analog channels. NAC (and group ID) detect can be disabled by the monitor mode described in Section 5.2.

5.14.4 P25 Group Calls

P25 group calls are placed by simply selecting the channel programmed for the desired group, monitoring the channel if required, and transmitting.

When a P25 group call is received, the alias (or frequency) of the selected channel is displayed. The radio can be programmed so that the following are also displayed for 0.5-7.0 seconds or continuously during the call.

P25 PTT ID- The unit ID of the radio placing the call is displayed.

P25 Talk Group - The alias of the talk group on which the call is being received is displayed.

User Group ID - If the group ID of the call being received is included in a pre-programmed User Group ID list, the alias programmed in that list for that group is displayed.

5.14.4.1 Changing a Channel Talk Group

If the Digital Talk Group Select option switch or Select TG menu parameter is programmed, the talk group assigned to a channel can be changed by the user. The new talk group continues to be assigned to the channel until it is manually changed again (cycling radio power or selecting another channel does not reselect a default talk group). Change the talk group assigned to a channel as follows:

- 1 Select the channel to be changed.
- 2 To select the talk group from the list of programmed talk groups, briefly press the Talk Group Select option switch or select the **Select TG > ID List** menu parameter. Then press the Up/Down switch until the alias of the desired talk group is displayed. If talk group selection has been disabled on the channel by programming, "NO LIST" is displayed, a tone sounds, and no change occurs. Press the <F2> switch to select the talk group and return to normal operation.
- 3 To enter a new talk group number from 1-65,535, press and hold the Talk Group Select option switch or select the **Select TG > Enter ID** menu parameter. Enter the desired talk group directly using the keypad. If less than five digits are entered, press the <F2> switch to select the talk group and return to normal operation.

5.14.5 P25 Unit Calls

Unit Calls (also called Individual Calls) can be placed to a specific radio on a Project 25 channel if the Unit Call option switch or menu parameter is programmed. Only the individual ID of the target radio is sent (a talk group ID is not sent). The radios that can be called are pre-programmed in the Unit Call list.

To receive a Unit Call, the RF channel of the call must be selected or scanned and the correct NAC and unit ID must be detected. The ID of the calling radio is then transmitted back. To respond to the call, the radio must be programmed with the Unit ID option switch or menu parameter, and have a Unit Call programmed for the ID of the calling radio.

Place and receive a Unit Call as follows:

- 1 To transmit a Unit Call, press the Unit Call option switch or select the Unit Call menu parameter. The alias (tag) of the last Unit Call is displayed.
- 2 If required, press the Up/Down switch to display the desired call. The alias and ID of the calls that have been programmed are alternately displayed.
- 3 Press and release the PTT switch. The display indicates the Unit Call ID. If no answer, the system times out after 20 seconds.
- 4 When a Unit Call is received, two beeps sound (if tones are enabled), and “Call Rcvd” and the alias of the unit ID are alternately flashed.
- 5 To respond, select the Unit Call mode by pressing the Unit Call option switch or selecting the menu parameter. The following operation then occurs:
 - If a unit call has been programmed with the ID of the calling radio, it is automatically selected. A response can then be made without changing the selected channel.

If no Unit Call has been programmed with the ID of the calling radio, a response cannot be made in this mode.
 - If the call timer times out (set by programming) or the channel is changed before a response is made, the unit call mode is exited.

5.14.6 P25 Conventional Telephone Calls

Telephone calls can be placed and received on P25 conventional channels. This feature allows telephone calls to be placed and received over the public telephone system using your radio. Telephone calls are programmed to operate in one of the following modes:

- Disabled
- Answer-only capability
- List only - Telephone numbers can be selected from a pre programmed list only (direct entry using the keypad is not allowed)
- Unlimited - Telephone numbers can be selected from a list and also dialed directly using the keypad.

Both limited and DTMF keypad models can place telephone calls by recalling the telephone number from a pre programmed list as just described. However, only DTMF keypad models can directly dial telephone numbers using the keypad.

5.14.6.1 Access/De-Access Codes

P25 conventional telephone calls utilize an access to access the system when placing a telephone call, and a de-access code to terminate the call when it is finished. These codes are pre programmed in pairs by the Access/De-Access Code list selected on the conventional **Per System** screen, and up to 16 pair can be programmed. Each conventional P25 channel can be programmed to automatically select one of these code pairs. They must match the system codes, and the default code is *1P# (the P represents a pause).

5.14.6.2 Placing a Telephone Call

To recall from a list:

- 1 Select the conventional channel that is programmed to select the desired access and de-access codes.
- 2 Momentarily press the Phone option key or select the **Phone > Num List** menu parameter. The display indicates the last number dialed by alternately displaying “Last Num” and the telephone number. In addition, the phone mode is indicated by the  icon.
- 3 If required, press the Up/Down switch to display the desired number. The alias and telephone number are alternately displayed.
- 4 Briefly press the PTT switch to send the access code. A dial tone sound should then be heard. Briefly press the PTT switch again to send the digits. Proceed to step 5.

To make a direct entry using DTMF keypad:

- 1 Select the conventional channel that is programmed to select the desired access and de-access codes.
- 2 Press and hold the Phone option key until a tone sounds (approximately one second) or select the **Phone > Enter Num** menu parameter. The alias of the last called telephone number is displayed if it is in the phone number list. Otherwise, only the last eight digits are displayed. In addition, the phone mode is indicated by the  icon.
- 3 Enter the telephone number using the 0-9, *, and # keys. To enter a pause (indicated by “P”), press *#. The number scrolls to the left in the display so that the eight right-most digits are always displayed. Numbers up to sixteen digits (including pauses) can be entered.
- 4 Briefly press the PTT switch to send the access code. A dial tone sound then be heard. Briefly press the PTT switch again to send the digits.
- 5 Press the PTT switch to talk and release it to listen. Since the radio operates half duplex, it is not possible to talk and listen at the same time.

- 6 When the telephone call is finished or if it could not be completed for some reason, end it by pressing the Phone option key or <FI> key. This sends the de-access code which tells the system that the call is finished and that the repeater can be released.

5.14.6.3 Answering a Telephone Call

- 1 When a telephone call is received, “ringing” similar to a standard telephone is heard and “Phone” is displayed.
- 2 To answer the call, press the Phone option switch or select that menu parameter and press the PTT switch to talk and release it to listen.
- 3 When the call is finished, end it as in the preceding step 6.

5.14.7 Call Alert

The Call Alert™ feature allows pages to be sent and received on P25 conventional channels. Operation is similar to SMARTNET/SmartZone and P25 Trunked channels.

To answer a page:

- 1 When a page is received, five beeps sound and “PAGE” is displayed. The ID of the radio paging you is stored as the last ID received.
- 2 To clear or ignore the page, press any option switch. If the PTT switch is pressed, a group call is placed on the selected channel.
- 3 To answer the page as a unit call (see Section 5.14.5), press the Unit Call option switch or select that menu parameter and the alias of the radio paging you is displayed. Press the PTT switch and respond. One of the following conditions then occur:
 - If the radio being called is on the air, ringing is heard until the called party answers or for 20 seconds, whichever occurs first. If no answer occurs within 20 seconds, a continuous tone sounds and “No Ans” is displayed.
 - If the radio being called is not on the air, a continuous tone is heard instead of ringing and “No Ack” is displayed.
- 4 When the call is finished or if it could not be completed for some reason, end it by pressing the Unit Call option switch or the <FI> (Exit) key.

To initiate a page:

- 1 With a P25 conventional channel selected, momentarily press the Call Alert option switch or select that menu parameter. The alias of the last ID called is displayed.
- 2 If required, press the Up/Down switch to display the desired radio. The alias of each number is displayed.

- 3 Press the PTT switch or the <F2> key and one of the following occur:
 - If five beeps sound, the system received the page and the paged radio is on the air and received it. The page mode is automatically exited.
 - If the system received the page but the called radio is not on the air, a single beep sounds and “No Ack” is displayed after six attempts after the PTT switch is pressed.

5.14.8 Messaging

The messaging feature allows pre programmed messages to be sent to a dispatcher on P25 channels. Up to 16 messages can be pre programmed, and they are identified by an alias. If a Message option switch or menu parameter is programmed, messages are sent as follows:

- 1 Momentarily press the Message option switch or select that menu parameter. The alias of the last message sent is displayed.
- 2 If required, press the Up/Down switch to display the desired message. Then send the message by pressing the <F2> key or momentarily pressing the PTT switch. One of the following events then occurs:
 - If five beeps sound and “Ack Recvd” is displayed, the message was received and automatically acknowledged by the system.
 - If after five tries the message is not acknowledged, a tone sounds and “No Ack” is displayed.

5.14.9 Status Messaging

The status messaging feature allows you to manually or automatically send your current status to your dispatcher on P25 channels. Up to eight status conditions can be pre programmed, and they are identified by an alias. If the Status option switch or menu parameter is programmed, status conditions are sent as follows:

- 1 Momentarily press the Status option switch or select that menu parameter. The alias of the current status condition is displayed.
- 2 To change the current status, press the Up/Down switch until the desired status is displayed. Then to send the status, press the <F2> (Select) switch or momentarily press the PTT switch. One of the following events then occurs:
 - If five beeps sound and “Ack Rcvd” is displayed, the status was received and acknowledged by the system.
 - If after five tries the message is not acknowledged, a tone sounds and “No Ack” is displayed.

5.14.10 P25 Packet Data

P25 packet data transmission capability is available with model 5100 ES portables. A P25 Packet Data option button or menu parameter must be programmed to toggle the data mode on and off.

The P25 Packet Data mode allows a subscriber unit to act as a packet data modem for a remote application connected to the subscriber unit via an RS-232 or SLIP (Serial Line Internet Protocol) connection. The SLIP connection requires an Ethernet port which is currently not available. The standard PC Configure programming cable provides the RS-232 port (female DB9 connector) for connecting the external data equipment to a 5100 ES portable.

5.15 Keypad Programming

Note *The Keypad programming feature is available to Federal Government users only. Users regulated by the Federal Communications Commission are not allowed to have this feature.*

Keypad programming can be enabled only if it has been enabled at the factory and a conventional mode option switch or menu parameter is programmed for the Keypad Programming function. The keypad programming mode is indicated by “Chng Zone” and  in the display.

Keypad programming allows conventional channel parameters such as the transmit and receive frequency, Call Guard squelch code, and encryption key to be changed. In addition, several conventional mode timers can be changed. It cannot be used to reprogram disabled channels or any SMARTNET/SmartZone/P25 Trunked information.

Figure 5.1 Keypad Programming Menu Flowchart

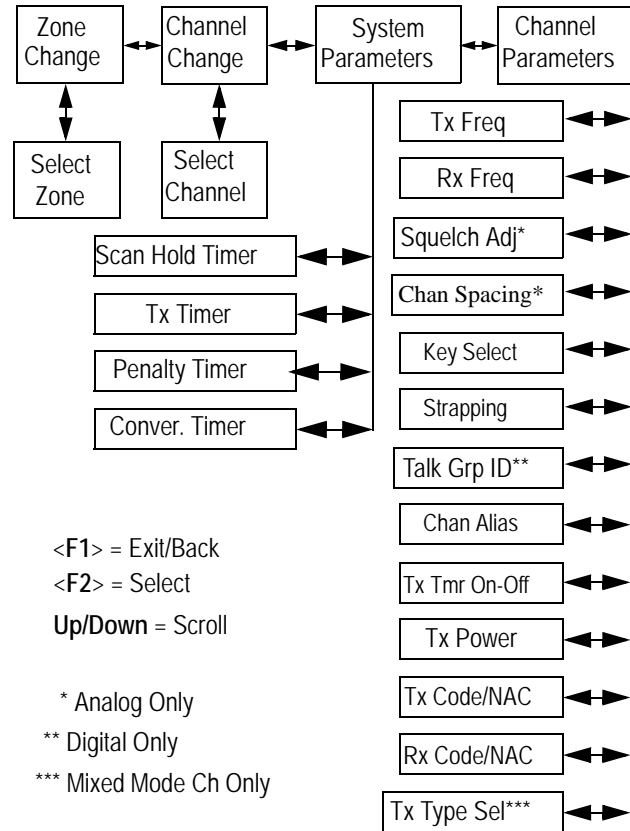

5.15.1 Menu Description

A menu system is used to select parameters in the keypad programming mode. A flowchart showing the keypad programming mode menu structure is located in Figure 5.1. When the keypad programming mode is selected by the Keypad Programming option switch or menu parameter, the first menu parameter “Chng Zone” is displayed as just described. Press the Up/Down switch to scroll through the available parameters which are as follows.

- CHNG ZONE
- CHNG CHAN
- SYS PARMS
- CHAN PARMS

Press the <F2> (Select) key to select a highlighted parameter, and press the <F1> key from one of the main menus to exit keypad programming. Pressing it in the other menus returns to the previous menu. The Up/Down switch is also used in several menus to scroll through available selections. Additional information on this parameters is located in the following sections.

5.15.2 Zone Password

Note *Ensure that the zone password(s) are not lost because they cannot be overridden in the field. The PC Configure software must be used to display the lost password or program a new password.*

Each zone can be programmed with a password by the PC Configure software to prevent unauthorized reprogramming of zone by keypad programming. When this password is programmed, it must be entered before system or channel parameters in that zone can be changed by keypad programming. The zone password is programmed in the **Zones > Edit Zone** screen of the PC Configure programmer. This screen is displayed by clicking the **Edit Zone** button. A different password can be programmed for each zone.

When an attempt is made to select a system or channel parameter in a password protected zone, “Password” is flashed. The password is always eight digits long and is entered using the same procedure as used for the power-up password described in Section 3.2. After the password is entered, system and channel parameters for that zone can be reprogrammed normally.

5.15.3 Zone Change Parameter

The “Chng Zone” menu parameter selects the zone containing the conventional channel to be reprogrammed. It does not change the zone selected for normal operation.

Press the <F2> switch to select the “Zone Chg” parameter and then scroll through the programmed zones by pressing the Up/Down switch. When the desired zone is displayed, select it by pressing the <F2> switch.

5.15.4 Channel Change Parameter

The “Chng Chan” menu parameter selects the conventional channel to be reprogrammed. Disabled or SMARTNET/SmartZone/P25 Trunked channels cannot be selected. This does not change the channel selected for normal operation.

Press the Select switch to select the “Chng Chan” parameter and then scroll through the programmed channels by pressing the Up/Down switch. When the desired channel is displayed, select it by pressing <F2> switch.

5.15.5 System Parameters

Note *If “Password” is briefly displayed when attempting to select a parameter, see Section 5.15.2.*

The “Sys ParmS” menu parameter selects the conventional mode timers to be reprogrammed (see following). Press the <F2> switch to select the “Sys ParmS” parameter and then press the Up/Down switch to display the desired parameter. Then press the <F2> switch again to select it.

Scan Timer - Selects the Scan Hold timer. Press the Up/Down switch to increment/decrement the timer in 0.5-second steps from 0-7.5 or set it to 0 seconds to disable it. When the desired value is displayed, store it by pressing the <F2> switch.

Tx Timer - Selects the transmit time-out timer. Press the Up/Down switch to increment/decrement the timer in 15-second steps from 0-225 or disable it by selecting 0 seconds. When the desired value is displayed, store it by pressing the <F2> switch.

Pen Timer - Selects the penalty timer. Press the Up/Down switch to increment/decrement the timer in 15-second steps from 0-225 or disable it by selecting 0 seconds. When the desired value is displayed, store it by pressing the <F2> switch.

Conv Timer - Selects the conversation timer. Press the Up/Down switch to increment/decrement the timer in 30-second steps from 0-450 or disable it by selecting 0 seconds. When the desired value is displayed, store it by pressing the <F2> switch.

5.15.6 Channel Parameters

Note *If “PASSWORD” is briefly displayed when attempting to select a parameter, see Section 5.15.2.*

The “CHAN PARMS” menu parameter selects the following conventional channel parameters that can be reprogrammed. Press <F2> switch to select the “Chan ParmS” parameter and then press the Up/Down switch to display the desired parameter. Then press the <F2> switch to select it. The squelch control parameters are unique to the type of conventional channel selected (analog or Project 25).

Note *If a mixed mode channel is selected, both the Rx Code (analog) and Rx NAC (P25) can be programmed. In addition, if the Tx Type is Analog, a Tx Code is programmed, and if it is Digital (P25), a Tx NAC is programmed.*

Tx Freq - Programs the transmit channel frequency. The digit being changed flashes, and press the Up/Down switch to select the desired number for that digit or enter it using the keypad. Then press the <F2> switch to move to the next digit if applicable. If an invalid frequency is entered, a beep sounds, “Invalid” is briefly displayed, and the number must be re-entered.

Rx Freq - Programs the receive frequency the same as the preceding Tx Freq.

Sq Adj (Analog Only) - Changes the preset squelch setting on that channel. The default setting is “0” and values of -7 to +7 can be selected. Increasing this setting toward +7 causes the squelch to open sooner so that weaker signals can be received, and decreasing it toward -7 causes the opposite to occur.

Note *The channel spacing is not set with P25 channels because it is always narrow, and the squelch cannot be changed because the setting is critical for proper receiver operation.*

Chan Spc (Analog Only) - Selects either wide or narrow band channel spacing on analog channels only. Press the Up/Down switch to select “Wide” or “Narrow”, and when the desired setting is displayed, store it by pressing the <F2> switch.

Note *The next two parameters are programmed only if the radio is programmed for encryption.*

Key Select - Selects the encryption key for the channel if applicable. The key storage location of 0-15 or 1-16 is displayed. If no keys are programmed, “No Keys” is displayed. Refer to Section 10.2 for more information.

Strapping - Selects the encryption strapping mode for the channel as Clear, Secure, or Switched. Refer to Section 10.3 for more information.

TG ID (P25 Only) - Selects the talk group for the selected channel. Press <F2> to display the current talk group ID and then press <F2> again to enter a different ID from 1-65,535. This number must be entered directly using the DTMF keypad.

Channel Alias - Programs the alias for the channel (DTMF keypad models only). Up to ten characters can be entered. Press <F2> once to display the current alias and then press it again to program a new alias. Alphanumeric characters are programmed using the 0-9 keys. Pressing a key once enters the first letter on the key and then pressing it successive times enters the letters and the number on the key. For example, press the “2” key twice to enter “B”. Press the <F2> key to move to the next position or press it twice to enter a space.

Tx Timer - Enables or disables the time-out timer on the current channel. Press the Up/Down switch to select the on and off mode, and when the desired setting is displayed, store it by pressing the <F2> switch.

Tx Power - Selects the desired power output level. Press the Up/Down switch to scroll through the following choices. When the desired setting is displayed, store it by pressing the <F2> switch.

- Power High - High transmit power
- Power Low - Low transmit power
- Power SW - Switchable power selectable by the High/Low power switch. This choice is not available if that switch is not programmed.

5.15.6.1 CTCSS/DCS Squelch Control (Analog Channel)

Tx Code - Programs the transmit Call Guard (CTCSS/DCS) code. The currently selected code and is initially displayed. Press the Up/Down switch to select the desired

code type (CTCSS analog or DCS digital). Then press <F2> to select it and enter the code number similar to programming a channel frequency as just described.

Rx Code - Selects the receive codes the same as Tx Code above.

5.15.6.2 NAC Squelch Control (Project 25 Channel)

TX NAC - Programs the transmit Network Access Code (NAC) which can be any number from 0-4095. With later models, this number is displayed in hexadecimal from 000-FFF. The procedure is similar to programming a TX FREQ just described. If an invalid code is entered, a beep sounds, "Invalid" is briefly displayed, and the code must be re-entered.

RX NAC - Selects the receive NAC the same as RX NAC above.

Transmit Type (P25 Mixed Mode Only) - If the selected channel is a mixed mode, analog and P25 channel, this selects the transmit type. Either Analog or Digital (P25) can be selected. This then determines if a Tx Code or Tx NAC is programmed above.

SMARTNET/SmartZone/P25 Trunked Features

An overview of the SMARTNET[®]/SmartZone[®] and P25 Trunked operating modes is located in Section 3.9. The following information describes the features unique to these modes of operation. Refer to the “Radio Wide Features” section starting on page 1 for information on features common to all operating modes.

6.1 Analog and Digital Operation

Either analog or digital operation can be selected for communication on traffic channels. Each talk group can be programmed for either type of operation. Digital operation may be an optional feature.

6.2 Viewing Unit ID

The 5100 ES has function button “Radio Info”. When this button is pressed, the following information is displayed.

- Unit ID (which is tied to the system that is currently active.)
- Software version
- Encryption key information
- Band

6.3 Standard Group Calls

Standard group calls may be placed to another radio, group of radios, or a dispatcher, depending on programming. Most calls are probably this type. Proceed as follows to place and receive group calls.

6.3.1 Placing a Standard Group Call

- 1 Turn power on and set the volume as described in Section 3.1. Select the channel programmed for the talk group you want to call (see Section 3.3).
- 2 If the talk group is programmed for encryption and is not strapped to Clear or Coded, select the desired mode by pressing the Clear/Secure option switch or selecting that menu parameter. The status cannot be changed if the talk group is strapped to Clear or Coded. Refer to Section 10.3 for more information.
- 3 Press the PTT switch and begin talking. An optional talk permit tone may sound to indicate when talking can begin. Events that may occur are as follows:
 - If in the secure mode and your radio is not programmed with the proper encryption key, “Keyfail” is displayed and the call must be made in the clear mode or the proper key must be programmed.

The user hears the key fail tone, and will not be allowed to transmit until secure mode is disabled or the proper key is loaded to the radio.
 - If the busy tone sounds and “Busy” is displayed, the system is busy. Release the PTT switch and wait for the call back tone to sound. Then press the PTT switch within three seconds.
 - If a continuous tone sounds and “No Sys” is displayed, you may be out-of-range. Drive closer or away from shielding objects and try again.
 - If your unit ID is invalid, the radio will not affiliate and is denied system access if the Unit ID is not displayed on system.
 - If an attempt is made to change an analog call from the clear to secure mode and there is no available secure channel, “No Sec” is flashed, an error tone sounds, and the call is terminated.
 - If an attempt is made to change an analog channel from the secure to clear mode, “SEC ONLY” is displayed, an error tone sounds, and the call is terminated. (Calls on digital channels can be changed if not strapped to clear or secure.)
 - If the secure mode is selected by the Secure/Clear option switch or menu parameter and an attempt is made to transmit on a channel strapped as clear, “Clear Only” is displayed and the transmitter is disabled. Likewise, if the clear mode is selected and the channel is strapped as secure, “Secure Only” is displayed and the transmitter is disabled.

6.3.2 Receiving a Standard Group Call

Calls are received on only the talk group and/or announcement group programmed for the selected channel (with scanning disabled). When the selected channel is programmed with both Talk and Announcement groups, only the Talk and Announcement group IDs are detected. Other IDs in the Announcement group are detected only if no talk group is programmed.

When a group call is received, the alias of the selected channel is displayed. The radio can be programmed so that the following are also displayed for 0.5-7.0 seconds or continuously during the call.

PTT ID- The unit ID of the radio placing the call is displayed.

TG on Rx - The alias of the talk group on which the call is being received is displayed.

User Group ID - If the group ID of the call being received is included in a pre programmed User Group ID list, the alias programmed in that list for that group is displayed.

6.4 Private (Unit-To-Unit) Calls

Note *With P25 Trunked operation, these calls are called Unit Calls, and they function the same as Enhanced Private Conversation calls described in the following information.*

Private calls allow calls to be placed to a specific radio unit. Either the Enhanced Private Conversation™ or standard Private Conversation modes may be programmed depending on the capabilities of the radio system. One difference between these call types is that the Enhanced type provides an indication that the called radio is not on the air and the standard version does not. Operation in each of these modes is described in the following information.

The Private Call option key is required to place these calls, and either that key or the Call Response option key is required to receive them. Private calls are programmed to operate in one of the following modes:

- Disabled
- Answer-only capability
- List only - Unit IDs can be selected from a preprogrammed list only (direct entry using the keypad is not allowed)
- Unlimited - Unit IDs can be selected from a list and also dialed directly using the keypad.

Both limited and DTMF keypad models can be programmed to recall the unit IDs from a preprogrammed list. However, only DTMF keypad models can be programmed to directly dial unit IDs.

6.4.1 Placing an Enhanced Private Conversation Call

To recall from a list:

- 1 Momentarily press the Private Call option key or select that menu parameter and the alias of the last called radio is displayed. The private call mode is indicated by  in the display.
- 2 If required, select another radio by pressing the Up/Down switch until the alias of the desired radio is displayed.
- 3 Press the PTT switch of the <F2> key to initiate the call.

(Proceed to the bulleted list which follows Item 3 in the next section for events that may occur next.)

To make a direct entry using the DTMF keypad:

- 1 Press and hold the Private Call option key until a tone sounds (approximately one second). The last ID called is displayed, and the private call mode is indicated by  in the display.
- 2 Using the 0-9 keys, dial the ID of the radio you are calling (five digits must be entered). To erase the last digit, press the Down key, and to cancel the call, press the Private Call Option key again.
- 3 Press the PTT switch to initiate the call. If the entered number is valid, the display indicates the alias of the ID if it matches an ID in the call list. Otherwise, the ID you entered continues to be displayed.

Events that may then occur are as follows:

- If the radio being called is on the air, “Wait” is displayed and ringing is heard until the called party answers or for 20 seconds, whichever occurs first. Pressing the PTT switch or an option key stops the ringing but not the call. When the call is answered, the voice of the called party is heard.
- If the called radio does not answer within 20 seconds, a continuous tone sounds and “No Ans” is displayed.
- If the called radio is not on the air, a continuous tone sounds instead of the ringing tone and “No Ack” is displayed.
- If the busy tone sounds and “Busy” is displayed, the called radio has answered the call but the system is busy. When the system is no longer busy, the call back tone sounds.
- If your radio or the called radio is inhibited or not programmed to make this type of call or for the requested secure mode, “Rspns Only” is displayed and an alert tone sounds.

- If your radio does not have the proper encryption key, “Keyfail” is displayed and the call must be made in the clear mode by pressing the Clear/Secure option key (if strapped to switchable). Otherwise, load the correct key.
- 4 When the call is finished or is not answered, end it by pressing the Private Call option key or the <F1> (Exit) key.

6.4.2 Placing a Standard Private Conversation Call

To recall from a list:

- 1 Momentarily press the Private Call option key or select that menu parameter. The alias of the last called radio is displayed, and the private call mode is indicated by  in the display.
- 2 If required, select another radio by pressing the Up/Down switch until the alias of the desired radio is displayed.
- 3 Press the PTT sw or the <F2> key to initiate the call.

(Proceed to the bulleted list which follows Item 3 in the next section for events that may occur next.)

To make a direct entry using DTMF keypad:

- 1 Press and hold the Private Call option key until a tone sounds (approximately one second). The last ID called is displayed, and the private call mode is indicated by  in the display.
- 2 Using the 0-9 keys, dial the ID of the radio you are calling (all six digits). To erase the last digit, press the Down key, and to cancel the call, press the Private Call Option key again.
- 3 Press the PTT switch to initiate the call. If the entered number is valid, the display indicates the alias of the ID if it matches an ID in the call list. Otherwise, the ID you entered continues to be displayed.

Events that may then occur are as follows:

- The called party answers the call.
- The called party does not answer. Press the Private Call option key or <F1> (Exit) to end the call.
- If the selected radio ID is not valid, “Invalid ID” is displayed and an alert tone sounds.
- If the radio system is busy, four low tones sound and “Busy” is displayed. When the system is no longer busy, the call back tone (four beeps) is heard and the channel is automatically acquired. Press the PTT switch to continue the call.

- If the call is in the secure mode and the radio does not have the proper encryption key, “KEYFAIL” is displayed and the call must be made in the clear mode by pressing the Clear/Secure option key or selecting that menu parameter (if strapped to switchable). Otherwise, load the correct key.
- 4 When the call is finished or if it is not answered, end it by pressing the Private Call option key or the <FI> (Exit) key.

6.4.3 Receiving a Private Call (All Types)

- 1 When a private call is received, “Call Rcvd” is displayed and the call tone sounds once.
- 2 To answer the call, press the Private Call option key or select that menu parameter and then press the PTT switch and begin speaking. The unit ID of the calling radio is displayed. More information follows:
 - If the PTT switch is pressed before the Private Call option key, the call is transmitted as a group call.
 - If private calls are not permitted (the Private Call option key/menu parameter is not programmed), press the Call Response option key or select that menu parameter to answer the call.
 - The call must be answered within 20 seconds or it is automatically terminated.
 - Ring times for both Tx and Rx radios are programmable in P25 Trunking (Individual Call Maximum Target Ring field), which sets the maximum ring time of the target mobile when receiving phone and unit-to-unit calls. When this time expires, the call is automatically discontinued. Times of 61-120 seconds can be programmed with 61 seconds the default.
 - The Private Call Maximum Int Ring parameter sets the maximum time the initiating mobile rings when placing a unit call (phone calls not included). Ringing stops if the target mobile answers before this timer expires. Times of 1-255 seconds or infinite can be programmed with 30 seconds the default. If infinite is programmed, ringing occurs until the target mobile answers.)
 - If the system is busy when a response is made, the busy tone sounds.

6.5 Telephone Calls

The telephone call feature allows telephone calls to be placed and received over the public telephone system using your radio. Telephone calls are programmed to operate in one of the following modes:

- Disabled
- Answer-only capability

- List only - Telephone numbers can be selected from a pre programmed list only (direct entry using the keypad is not allowed).
- Unlimited - Telephone numbers can be selected from a list and also dialed directly using the keypad.

Both limited and DTMF keypad models can place telephone calls by recalling the telephone number from a pre programmed list as just described. However, only DTMF keypad models can directly dial telephone numbers using the keypad. The keypad remains active during a call for over dialing DTMF digits.

6.5.1 Placing a Telephone Call

To recall from a list:

- 1 Momentarily press the Phone option key or select that menu parameter. The alias of the last called telephone number is displayed. The interconnect call mode is indicated by  in the display.
- 2 If required, press the Up/Down switch to display the desired number. The alias of each number is displayed.
- 3 Press and release the PTT switch and “Dialing” is displayed. Refer to the bulleted list following step 3 below for events that may then occur.

To make direct entry using DTMF keypad:

- 1 Press and hold the Phone option key until a tone sounds (approximately one second). The alias of the last called telephone number is displayed if it is in the phone number list. Otherwise, the last eight digits of the last called telephone number are displayed. The interconnect call mode is indicated by  in the display.
- 2 Enter the telephone number using the 0-9, *, and # keys. To enter a pause (indicated by “P”), press * and then #. To erase the last digit, press the <FI> key. The number scrolls to the left in the display so that the eight right-most digits are always displayed. Numbers up to sixteen digits (including pauses) can be entered. Press the Phone option key to cancel the call.
- 3 Press and release the PTT switch and “Dialing” is displayed. Events that may occur are as follows:
 - If the access is successful, a dial tone sounds and the dialed number is displayed and sent. Either ringing or a busy signal is then heard as with a standard telephone call. When the called party answers, press the PTT switch to talk and release it to listen (since the radio is half-duplex, it is not possible to talk and listen at the same time). Each time the PTT switch is released, a go-ahead tone is sent to the landside party to indicate when they can respond. To dial a number after the connection is made, press the PTT switch and dial the number using the microphone keypad.

- If the selected telephone number is not valid, “Invalid” is displayed and an alert tone sounds. Select a valid number.
 - If the system is busy, “Busy” is displayed and the busy tone sounds. The call will automatically proceed when the system becomes available.
 - If you are out-of-range or the radio cannot be accessed for some reason, “No Phone” is displayed and an alert tone sounds.
 - If the interconnect call you are making or the selected secure mode is not authorized, “Reject” is displayed and an alert tone sounds.
 - If your radio does not have the proper encryption key, “Keyfail” is displayed and the call must be made in the clear mode using the Clear/Secure option key or menu parameter (if encryption is selectable on the channel). Otherwise, load the proper encryption key.
- 4 When the telephone call is finished or if it could not be completed for some reason, end it by pressing the Phone option key or <FI> (Exit) key.

6.5.2 Answering a Telephone Call

- 1 When a telephone call is received, “ringing” similar to a standard telephone is heard and “Phone” is displayed.
- 2 To answer the call, press the Phone option switch or select that menu parameter and press the PTT switch to talk and release it to listen. Since the radio operates half duplex, it is not possible to talk and listen at the same time.
- 3 When the call is finished, end it by pressing the Phone option switch or <FI> (Exit) key.

6.6 Call Alert

The Call Alert™ feature allows pages to be sent and received. With SMARTNET/SmartZone operation, either the Enhanced Private Conversation™ or Standard Private Conversation mode may be programmed depending on the capabilities of the radio system. With P25 Trunked operation, operation is similar to the enhanced mode.

6.6.1 Answering a Page

- 1 When a page is received, five beeps sound and “Page” is displayed. The ID of the radio paging you is stored as the last ID received.
- 2 To clear or ignore the page, press any option switch.

- 3 To answer the page as a private call (see Section 6.4), press the Private Call option switch or select that menu parameter and the alias of the radio paging you is displayed. Press the PTT switch and respond.

6.6.1.1 Enhanced Private Conversation Mode

- If the radio being called is on the air, ringing is heard until the called party answers or for 20 seconds, whichever occurs first. If no answer occurs within 20 seconds, a continuous tone sounds and “No Ans” is displayed.
- If the radio being called is not on the air, a continuous tone is heard instead of ringing and “No Ack” is displayed.

6.6.1.2 Standard Private Conversation Mode

- If the radio being called is not on the air or does not answer, you will simply not hear a response.
- 4 When the call is finished or it could not be completed for some reason, end it by pressing the Private Call option switch or the <F1> (Exit) key.

6.6.2 Initiating a Page

- 1 With a SMARTNET/SmartZone or P25 Trunked channel selected, momentarily press the Call Alert option switch or select that menu parameter. The alias of the last ID called is displayed.
- 2 If required, press the Up/Down switch to display the desired radio. The alias of each number is displayed.
- 3 Press the PTT switch or the <F2> key and one of the following occur:
 - If five beeps sound, the system received the page and the paged radio is on the air and received it. The page mode is automatically exited.
 - If the system received the page but the called radio is not on the air, a single beep sounds and “No Ack” is displayed 6 seconds after the PTT switch is pressed. Auto exit then occurs.

6.7 Messaging

Note *This feature is not available with P25 trunked operation.*

The messaging feature allows preprogrammed messages to be sent to a dispatcher. Up to 16 messages can be preprogrammed, and they are identified by an alias. If a Message option switch or menu parameter is programmed, messages are sent as follows:

- 1 Momentarily press the Message option switch or select that menu parameter. The alias of the last message sent is displayed.
- 2 If required, press the Up/Down switch to display the desired message. Then send the message by pressing the <F2> key or momentarily pressing the PTT switch. One of the following events then occurs:
 - If five beeps sound and “Ack Rcvd” is displayed, the message was received and automatically acknowledged by the system.
 - If after five tries the message is not acknowledged, a tone sounds and “No Ack” is displayed.

6.8 Sending Status Conditions

The status feature allows you to manually or automatically send your current status to your dispatcher. Up to eight status conditions can be preprogrammed, and they are identified by an alias. If the Status option switch or menu parameter is programmed, status conditions are sent as follows:

- 1 Momentarily press the Status option switch or select that menu parameter. The alias of the current status condition is displayed.
- 2 To change the current status, press the Up/Down switch until the desired status is displayed. Then to send the status, press the <F2> (Select) switch or momentarily press the PTT switch. One of the following events then occurs:
 - If five beeps sound and “Ack Rcvd” is displayed, the status was received and acknowledged by the system.
 - If after five tries the message is not acknowledged, a tone sounds and “No Ack” is displayed.

6.9 Emergency Alarm and Call

Emergency Alarms and Calls are separate functions that can be individually enabled or disabled on each SMARTNET/SmartZone and P25 Trunked system. The Emergency option switch (or menu parameter) is required for these functions. Other emergency features are as follows:

- Emergency Alarms are transmitted on the selected talk group if emergency calls are disabled, and on the emergency talk group if emergency calls are enabled.

- Emergency Alarms are transmitted on the Control Channel. If the emergency call checkbox is checked, the radio will transmit an emergency call on the selected talkgroup if no emergency talkgroup is programmed. If an emergency talkgroup is programmed, the call will be transmitted on the emergency talkgroup
- Emergency Call talk group selection priority is as follows. For example, if a global emergency channel is not programmed, the emergency talk group of the selected channel is used and so on.
 - a Global (radio wide) emergency channel
 - b Emergency group of the selected channel
 - c Talk group of the selected channel
 - d Announcement group of the selected channel

6.9.1 Emergency Alarms

An emergency alarm is a special transmission that alerts a dispatcher of an emergency situation. It is sent automatically by simply pressing Emergency option switch or selecting the Emergency menu parameter. The system to which the emergency channel is linked must have Emergency Alarms enabled. If not, Emergency Alarms are disabled. The alarm is sent on the control channel.

Proceed as follows to send an emergency alarm:

- 1 If required, select a channel of a system on which Emergency Alarms are enabled and then press the Emergency option switch or select that menu parameter. The radio then automatically transmits the emergency alarm.
- 2 Either Normal or Silent operation can be programmed. With the Normal mode, the red LED lights, the emergency tone sounds, and “EMERGENCY” flashes in the display. This indication continues to flash until the alarm mode is ended (see step 4). If silent programmed or the Surveillance mode is selected (see Section 4.8), none of these indications occur. If “No Receive Activity During Emergency” is programmed, receive audio, the front panel LED, and receive icons are disabled in the receive mode.
- 3 When the emergency alarm is acknowledged, “Ack Rcvd” is briefly displayed and the emergency acknowledge tone (five beeps) sounds. Silent operation may also be programmed in which case no tone sounds and there is no indication that an acknowledgment occurred.
- 4 The radio continues to transmit this message until an acknowledgment is received or the programmed number of attempts have been made. The emergency alarm mode is exited when radio power is cycled or by pressing and holding the Emergency option switch.

6.9.2 Emergency Calls

An emergency call urgently requests access to a voice channel (an emergency tone usually does not sound at the console). An emergency call is placed by pressing the PTT switch after pressing the Emergency option button or selecting the Emergency menu parameter. If the Emergency Hot Mic feature is enabled, the emergency call is automatically transmitted without having to press the PTT switch (see following description).

6.9.2.1 Emergency Hot Mic

If Emergency Hot Mic has been enabled for emergency calls, automatic transmitting occurs with microphone audio unmuted without having to manually press the PTT switch. The automatic transmit period is programmed for 10-120 seconds in ten-second intervals. If this feature or emergency calls are not enabled by programming, automatic transmitting does not occur. This feature is initiated only on the first press of the Emergency switch. Subsequent presses do not trigger automatic transmissions. To reset this function, the channel must be changed or power cycled.

6.9.2.2 Placing an Emergency Call

- 1 If required, select a channel of a system on which Emergency Calls are enabled and press the Emergency option switch or select that menu parameter. The Emergency Alarm is then sent as described in Section 5.9.1 if applicable.
- 2 Emergency alarm entry is played upon the pressing of the Emergency button. Console Ack is played when we get an ack back from the console for an emergency Alarm. Emergency Exit is played when you press and hold the emergency button. Below are the tones for Emergency.

Console Acknowledgement	Emergency Alarm Ack	Emergency Alarm Acknowledged Successful	Two 1000 Hz 175 ms tones with 50 ms spacing followed by Three 1000 Hz 175 ms tones with 150 ms spacing
Emergency Alarm Entry	Emergency Button Press	Emergency button has been Pressed	1000 Hz continuous tone for 175 ms.
Emergency Exit	Emergency Canceled	Emergency is Canceled	1000 Hz continuous tone for 1 sec.

- 3 If the preceding Emergency Hot Mic feature is enabled, the call is automatically transmitted without pressing the PTT switch. If it is disabled, press the PTT switch and begin speaking as with a standard call.
- 4 All group calls which follow are then emergency calls (private, telephone, and call alert calls are not allowed). If the channel is changed, the call is made on the emergency talk group programmed for the new channel. If the Surveillance Mode is enabled (see Section 4.8), the radio will behave in accordance to the individual surveillance mode

options. If “No Receive Activity During Emergency” is programmed, receive audio and the front panel LED are disabled in the receive mode.

- 5 To exit this mode, cycle radio power or press and hold the Emergency switch.

6.9.3 External Emergency Feature

A special man-down switch (currently available only from third-party vendors) is attached to the accessory connector of the radio. Then if this feature is enabled by programming and the radio is in a horizontal position for longer than the programmed time (0-63 seconds), an emergency condition is triggered the same as if the Emergency switch was pressed. The emergency can be canceled by a press and release of the Emergency switch. Note that accessories such as speaker-microphones cannot be used with this feature.

6.10 Failsoft Operation

If a failure occurs in the SMARTNET/SmartZone or P25 Trunked system so that it cannot be used, the system directs the radio to automatically enter the failsoft mode. When in this mode, “Failsoft” and the alias of the selected channel are alternately displayed. A failsoft tone may also be heard, depending on how the repeater is programmed.

When in the failsoft mode, operation is in the conventional mode on the preprogramming failsoft channel (a different failsoft channel can be programmed on each talk group). If a transmission is attempted before a failsoft channel is located, a continuous tones sounds until the PTT switch is released. When the radio system returns to normal operation, this is automatically detected and normal operation resumes.

6.11 SMARTNET/SmartZone/P25 Trunked Scanning Features

Scanning on a SMARTNET/SmartZone and P25 Trunked systems is called Priority Monitor Scan. The following are unique features of this type of scanning. For general scanning information applicable to all operating modes, refer to Sections 4.9 and 4.10.

- Scanning is turned on and off by the Scan option switch or menu parameter. Talk groups (channels) can be programmed so that scanning automatically starts when the talk group is selected (Autoscan).
- When responding to calls in the scan mode, the programming of the Talkback Scan parameter determines if a response always occurs on the talk group of the call (Active Group) or the Selected Group if they are different. Transmissions at other times always occur on the selected talk group.
- Each talk group can be programmed to select one of the programmed scan lists or “No List” (scanning is disabled). If scanning is enabled and the selected channel does not

permit scanning, it is automatically enabled again when a channel is selected that permits scanning.

- Up to 256 scan lists, each with up to 512 talk groups from the same system can be programmed. The selected scan list can be temporarily changed and edited as described in Section 4.10.1.
- In addition to calls on channels in the scan list, pages, private/unit calls, and telephone calls are received while scanning. Private and telephone calls are not interrupted by priority messages.

6.11.1 Priority Talk Group Sampling

The 5100 ES radio supports Dual Priority talk groups in all trunking and conventional formats. When scanning, messages on a non-priority talk group are interrupted by messages on the priority talk group. Priority scanning must also be supported at the system level for it to occur as programmed in the radio.

6.12 Dynamic Regrouping

The dynamic regrouping feature allows a dispatcher to change the current talk group or switch radios to a predefined regrouping channel to receive an important message. When the console issues a regroup order, the radio switches to the pre programmed regroup talk group.

If the Cancel Dynamic Regrouping option switch or menu parameter is programmed, it can be used to exit the dynamic regrouping mode if desired.

Otherwise, if the lock mode was not specified, the selected talk group can be manually changed and the previous talk group is reselected. If a locked regroup command is received, the displayed talk group cannot be changed manually or by cycling power. It can be changed only after a clear order is received from the console.

Dynamic regrouping operates as follows:

- 1 When this command is received, a 765 Hz tone sounds every 25 ms for 300 ms and the radio automatically changes to the regrouping channel. “Dyn Regrp” is displayed.
- 2 Talk and listen as usual. When dynamic regrouping is canceled by the dispatcher, a short tone sounds. If a standard channel is not selected after this occurs, transmission is not allowed if the talk group is assigned as a dynamic regrouping talk group only. If it is assigned as a normal talk group, normal transmissions are allowed.

6.13 SmartZone and P25 Trunked Unique Features

P25 Trunked and SmartZone modes can provide access to single or multi-site systems. The P25 Trunked mode can provide access to a single trunked site or roaming between several trunked sites.

6.13.1 Busy Override

The busy override feature is enabled at the system level by the system manager and is not a programmable radio feature. It allows a call to be placed even if not all sites you are calling have a free traffic channel. The only sites guaranteed to be included are the Critical Sites and the sites where a Critical User is located. This feature operates as follows:

- 1 Assume that you have attempted to place a call and the system was busy (“Busy” displayed and busy tone sounded).
- 2 Release the PTT switch and then press it for five seconds or more. If a chirp tone sounds with the PTT switch pressed, busy override is occurring.

Note *Remember that not all members of the talk group are receiving your message. Missing members will start receiving your message as channels become available.*

6.13.2 Site Trunking

Site trunking occurs when a site can no longer participate in wide area trunking. It is disconnected from other sites and only supports calls with other radios on that site and cannot route audio to other sites. When site trunking is occurring, the radio searches for other sites that may provide wide area coverage.

Site trunking ends when a wide area coverage site is located, the current site is operating again as a wide area coverage site, an out-of-range condition occurs, or the failsoft mode is entered. The radio can be programmed so that “Site Trunking” is displayed and/or an alert tone sounds when site trunking occurs.

SmartZone and P25 trunked systems can be programmed for “Disable Site Trunking Operation”. The radio is then not allowed to start or operate on a site trunking site. If a site goes into site trunking, the radio leaves that site’s control channel and attempts to find another valid wide area site. If no wide area site is available, the radio will continue searching for another wide area control channel for check for failsoft if failsoft is enabled and displays “Out-of-Range”. If a site adjacent to the current Home Site was in site trunking but then enters wide area trunking, it is evaluated to determine if it should move to that site as a better site.

6.13.3 Determining Current Site and Searching For New Site

To display the RSSI level of the current site, press the Site Search option switch or select that menu parameter. The display then indicates the current site number as “Site xx” and the RSSI level as “RSSI xx”. This mode is then automatically exited.

To scroll through the other programmed sites, press and hold the Site Search option switch while “Site xx” or “RSSI xx” is displayed. If site lock is on when site search is entered (see following), the radio will be locked on the new site when this function is exited.

6.13.4 Locking/Unlocking a Site

It is sometimes desirable to stay on a site. To prevent the radio from searching for a new site, lock it on the current site by pressing the Site Lock option switch or selecting that menu parameter. The display then momentarily indicates the site alias to indicate that the current site is locked (“x” is the current site number). To unlock the site, press the Site Lock switch again or the <F2> (Select) key and “Unlock” is momentarily displayed.

6.13.5 Auto Site Search

Auto site search automatically searches and selects the best site available. Site Search is set normally set to OFF. When the option button is pressed, the user can scroll through the list of available sites and the select a site on which to operate.

6.13.6 ZoneFail Site Lock

This is an optional feature that can be enabled only by factory programmed. It is not programmed by the PC Configure software, and does not require any special inputs from the infrastructure to operate. This feature is intended to prevent some of the confusion resulting from a site controller failure. When this occurs, all sites go into the Site Trunking mode and radios continue to roam normally according to RSSI level. The result is that the various radios selected by a particular talk group may be operating on different sites and are unable to talk to each other (see Section 6.13.2 for more Site Trunking information).

With the Zone Fail Site Lock feature enabled, the radio continues to roam normally when the system zone controller is active. However, if the zone controller fails, this is detected and the Zone Fail Site Lock mode is entered. The only site the radio is then allowed to operate on is its home site. If its home site is not available, “Out-of-Range” is displayed. A zone controller failure is detected by determining that every site in the dynamic site list is in Site Trunking. Currently, this condition must be detected for at least one minute for the Zone Fail Site Lock mode to be selected.

The result of this operation is that all radios with the same programmed home site are forced to the home site to communicate which ensures that they can continue to communicate. If the home site is not available, the Out-of-Range condition tells the user to attempt communication on another system or by some other means.

6.13.7 P25 Wide Area Scan

This feature is intended to enhance roaming performance, especially when system level steering via radio or talk group permissions is used.

6.13.7.1 Normal P25 and SmartZone Control Channel Hunt

The following control channel search methods are normally used to find a control channel:

Short Hunt - The dynamic array of 7 (or 15) adjacent sites is searched. This list is saved on power down and loaded again at power up. It is erased whenever parameters are downloaded to the radio by the PC Configure programmer.

Long Hunt - If no valid control channel is located by the preceding short hunt method, the radio searches the list of control channels programmed into the radio by the PC Configure programmer.

Full Spectrum CC Scan - If the two preceding methods do not locate a control channel, every channel available to the radio is searched.

6.13.7.2 Talkgroup Steering Via System Access Permissions

To use system channel resources more efficiently, some system operators are using system access permissions to steer certain talkgroups to particular sites. For example, a police department may be allowed to use only Site 1, and a public works department may be allowed to use only Site 2.

The problem with this operation is that every time a different talk group is selected, the access permission may be different and a different site may need to be accessed. This could result, in a worst case, in a delay of up to 30 seconds in finding a new site. This could occur if there are no valid sites for the new talk group in the dynamic site list.

6.13.7.3 P25 Wide Area Scan

A feature called Wide Area Scan can be programmed to minimize the problem just outlined. This feature is programmed on the Talk Group list screen selected on the P25 System screen. When Wide Area Scan is selected, talk group site preferences are no longer available. However, System Site Preference lists can still be used. The Wide Area Scan feature functions as follows:

- 1 Assume TG1 is selected. If it is the first time this talk group is selected, normal searching for a control channel occurs according to the hunt methods previously described.
- 2 When another talk group is selected, the active valid site for TG1 is stored in EEPROM memory.
- 3 The next time TG1 is selected, the following procedure is performed before performing the normal hunt methods previously described.
 - a The last valid site ID and its receive and transmit channel numbers are loaded from EEPROM memory.
 - b The dynamic site list is checked to see if any newer receive/transmit channel information is available for the last site ID.
 - c The best receive/transmit information is used and the radio checks to see if this control channel is available.

The result of the preceding operation is that the radio has a reasonable chance of finding a valid site, usually on the first try. This greatly reduces access time, even on systems which have highly restricted talk group based access.

Miscellaneous

7.1 Signaling Tones











Information is communicated to users of the 5100 ES radio using signal tones and alerts and by LED signaling. Table 7.1 shows the information and signaling tones supported by the 5100 ES radio. If you are viewing a PDF of this manual on a computer equipped with a sound card, double-click on the Horn icon () next to the Message Name to hear the tone.

Table 7.1 Tones for the 5100 ES Radios

Message Name		Message Description	Audible Description	Tone Category
Action Performed		An action has been performed such as selecting an item in List	One high pitched beep, one medium pitched beep and one high pitched beep	Keypress
Alert		TX Warning Timer for Group, Unit, and Interconnect Calls	High Pitched Beep	Action
Alert Site Trunking		Radio is in Site Trunking	High pitched beep	Action
Alert Tone Adjust		Used when adjusting the Volume for Alert Tones	Medium pitched tone	Keypress
Analog Signaling Side Tone		Occurs during Conventional Analog Pre ANI Signaling	Medium pitched continuous tone	Action
Automatic Call Back		A Voice Channel is available from a previous request	One high pitched beep, one medium pitched beep and one high pitched beep	Action
Bad		Invalid Key Presses, Inadequate Permissions / Self Test Fail	Short Low Pitched Tone	Action
Call Alert ACK		Call Alert Acknowledgement has been Received	Six medium pitched beeps	Action
Call Alert Received		Call Alert Page has been Received	Six medium pitched beeps repeated every 6 seconds	Action
Channel Busy		System is currently busy	Group of 4 Low Pitched Tones	Action

Miscellaneous

Table 7.1 Tones for the 5100 ES Radios (Continued)















Message Name	Message Description	Audible Description	Tone Category
Clear Alert Tone	 Radio receives a Secure call while in a Clear Mode - PCC Option	Medium Pitched Beep	Action
DTMF Keypress	 DTMF Keypress	Medium pitched continuous tone	Action
Dynamic Regrouping	 <ul style="list-style-type: none"> • Dynamically Regrouping Command has been received • Talk Permit Tone while Dynamic Regrouped 	Gurgle	Action
Emergency Alarm ACK	 Emergency Alarm Acknowledged Successful	A group of 5 medium pitched tones	Action
Emergency Button Press	 Emergency button has been Pressed	Medium pitched long tone	Action
Emergency Canceled	 Emergency is Canceled	Medium pitched very long tone	Action
Enhanced Unit Call	 Enhanced Unit Call is Received	Three medium pitched tones repeated 4 times every 6 seconds	Action
Error	 Timeout States, Change Keypad Fail, TX Timeout, Attempt to TX Clear when Strapped Secure and vice versa	Low Pitched Continuous Tone	Action
Failsoft	 Trunking System has Failed	Two medium pitched beeps repeated continuously	Action
Feature Off	 Binary Feature has been Turned Off	Medium pitched beep followed by a lower pitched beep	Keypress
Key Fail	 After channel change, Radio does not have the assigned key	Six medium pitched long tones	Action
Key Fail PTT	 After PTT, Radio is in Secure mode but does not have the assigned key	Continuous medium pitched long tones	Action
Keyloader/Menu Enter Mode	 Enter Menu Mode, Keyloader Attached	Medium Pitched Beep followed by a higher pitched beep	Keypress
Keyloader/Menu Exit Mode	 Exit Menu Mode, Keyloader Detached	High pitched beep followed by a medium pitched beep	Keypress
Low Battery	 The battery strength is getting low. Charge or replace the battery immediately	Two medium pitched beeps	Action
Message / Status ACK	 Message / Status Acknowledgement has been Received	Six medium pitched beeps	Action
Non-Enhanced Unit Call	 Non Enhanced Unit Call is Received	Two medium pitched beeps repeated every 6 seconds	Action
OTAR Acknowledgement	 OTAR Hello Acknowledgement Received	High Pitched Beep	Action
Out of Range	 Trunking Radio is in an Out of Range State	Low pitched, very long tone repeated	Action
Priority Call Received	 Radio has received a Priority Call	Two low pitched beeps	Action
Radio Self-Test Pass	 Self Test has Passed	Medium Pitched Beep followed by a higher pitched beep	Keypress

Table 7.1 Tones for the 5100 ES Radios (Continued)

Message Name	Message Description	Audible Description	Tone Category
Return to Normal	 <ul style="list-style-type: none"> Dynamic Regrouping has been Canceled Voltage has returned to Normal Temperature has returned to Normal Conventional: TX Penalty Timer has Expired 	Medium Pitched Beep followed by a higher pitched beep	Action
Ring	 Radio has received an interconnect and is waiting for Unit Call target subscriber to respond	Telephone Ringing	Action
System Retry	 Tone that occurs after the 2nd ISP or ISW retry	Continuous low pitched tone	Action
Talk Permit Tone	 (When PTT Button is Pressed) verifying that the system is accepting transmissions	Three medium pitched beeps	Action
Temperature Change	 Temperature has changed from Normal to Hot or Too Hot	Two medium pitched beeps	Action
Unprogrammed Channel	 Radio is turned to an Unprogrammed Channel	Low Pitched Continuous Tone	Action
Valid Keypress / Feature On	 Valid Key Press or a Feature has been turned on	Medium Pitched Short Tone	Keypress
Volume Boundary	 Volume boundary reached when adjusting the volume with Volume Up / Down Buttons	Two medium pitched beeps	Action

The 5100 ES radio transfer standard functional display text information via the serial port. The radio signals the user via the LED when the radio is in code upgrade boot-load mode. The LED blinks green while in this mode. LED signaling states are described in Table 7.2.

Table 7.2 LED Indicators

LED Color	LED Duration	Description
Red	On	Tx: clear
Red	125 ms ON 125 ms OFF	Tx: CLEAR with low battery Tx: trunking system busy
Red	125 ms ON 125 ms OFF 125 ms ON 750 ms OFF	Rx: Secure Group
Red	750 ms ON 125 ms OFF	Rx: Secure individual call
Green	ON	Rx: clear conventional or trunking
Green	750 ms ON 125 ms OFF	Rx: clear individual call
Orange	Continuous until Self Test complete	Self Test state
Orange	ON	Tx: Secure
Orange	125 ms ON 125 ms OFF	Tx: SECURE with low battery

7.2 Error Messages

The following are definitions of the various error messages that may be displayed.

Aff Failed - A group affiliation attempt has received a Failed response from the system. The precise reason for a Failed response is manufacturer dependent.

Aff Deny - A group affiliation attempt has received a Denied response from the system. The precise reason for a Denied response is manufacturer dependent. One common cause is that the group is disallowed on the site/RFSS that the radio is attempting to affiliate on.

Aff Refusd - A group affiliation attempt has received a Refused response from the system. The precise reason for a Refused response is manufacturer dependent.

Answer Only - The user has attempted to initiate a private call or interconnect call and the feature is programmed for answer only.

Bad Band - A profile/or user parameters have been downloaded with PC Configure that are for a band different from the hardware of the radio.

Bad ESN -The ESN of the radio is not valid. This error is usually only seen in the factory when first programming brand new logic boards.

Bad Fl Fmt - A profile/or user parameters have been downloaded to the radio that do not match the file format supported by the firmware/software in the radio.

Bad Hrdwar - The ESN of the radio is not valid. This error is usually only seen in the factory when first programming brand new logic boards.

Batt Low - The battery voltage has been detected as being low.

Busy - A call has been attempted and the system has responded that no channels are available for assignment.

Busy Tmout - The radio previously received a busy response from the system and it has not received a channel grant before the busy time-out timer has expired

Disabled - The selected channel is disabled.

Clear Only - The selected channel or group is strapped clear only and that a secure call can not be made.

Corrupt Prm - The radio has detected that its profile/user parameters are not valid because the functional blocks cannot be identified.

Denied - A group call attempt has received a Denied response from the system.

Deny - A unit or interconnect call attempt has received a Denied response from the system.

Disabled - The feature that the user is attempting to use has been disabled on the radio either by programming or by factory options.

DSP Failed - The main processor and the DSP have failed to complete their startup procedure at powerup.

EEPRM Fail - The main processor has timed out while trying to validate or invalidate the profile/user parameters in the EEPROM.

Encryp Bad - The main processor and the Encryption Module have failed to complete their startup procedure at power up.

Fixed High - The selected channel or group is strapped to high power and thus low power can not be selected.

Fixed Low - The selected channel or group is strapped to low power and thus high power can not be selected.

Too Hot - The mobile has passed the hot temperature threshold. Under these conditions the radio will only transmit in low power.

Invalid - The received input from the user does not fit the criteria necessary for the feature.

Invalid ID - The received ID from the user was not a valid ID.

Invald Key - The key pressed by the user was not valid for the current situation.

Invlid Ch - The channel entered by the user in keypad programming is not valid.

Key Fail - The encryption key required by the current selected group/channel is not valid.

Kypd Lockd - The keypad lock function is active and key presses are not accepted in this mode.

Kset Fail - The encryption key set chosen by the user is not valid.

List Only - Direct entry of a unit ID or phone number is disabled.

Locked - A selector lock command has been received and zone and channel changes are not accepted.

Lost Signl - Signal from the infrastructure has been lost during an interconnect call.

Low Power - The current channel is strapped to low power and that the user can not select high power at this time.

Msg Failed - The current channel is strapped to low power and that the user can not select high power at this time.

Narrow - The current conventional channel is programmed as a narrow channel.

No Ack - The radio did not receive an Acknowledgement for the current signaling attempt.

No Edit - The current list is not able to be edited.

No Encrypt - Encryption is not available for the selected channel.

No List - No list is available for the selected channel.

No Message - No message is programmed for transmission.

No Reply - Radio cloning failed due to no response.

No Service - OTAR service is not available.

No Site - No site with a verified ID is yet on the dynamic site list.

No Keys - No keys are available for the key select function.

Out Of Rng - This error indicates no control channel has been found for trunking operation.

Parms Fail - The checksum of the profile / user parameters does not match the calculated checksum. This indicates that there is an error in the parameters file. This message only occurs if the redundant copy of the parameters is also corrupt or is unable to be used.

Rekey Fail - This error indicates a failure in a rekeying process.

Rx Only - The selected channel is Rx only.

Sts Failed - No acknowledgement was received while sending a status report.

Timeout - A time out has occurred in attempting the current function.

Too Hot - The mobile has passed the "Too Hot" temperature threshold. Under these conditions the radio will not allow Tx.

Tx Timeout - The Tx time-out timer has expired and Tx has been terminated.

VOLTAGE HI - The input voltage to the mobile is too high.

VOLTAGE LO - The input voltage to the mobile is too low.

Write Fail - The radio is unable to write to the EEPROM.

7.3 System Operator Programming

As noted several times in this manual, programming determines the availability and specific operation of many features. This usually refers to the programming performed by the PC Configure programmer when the radio was set up, not to any programming a user can perform. If a feature is controlled by a front panel option switch and that switch is not available, it is probably not available.

If the Keypad Programming option switch is available, you can reprogram some conventional channel parameters. Refer to Section 5.15 for more information.

7.4 Speaking Into Microphone

For best results, hold the radio about 1-2 inches from your mouth and speak at a normal conversational level. Do not shout since it distorts your voice and does not increase range. Make sure that the PTT (push-to-talk) switch is pressed before you begin to speak and released as soon as the message is complete.

7.5 Operation At Extended Range

When approaching the limits of radio range, the other party may not be able to hear your transmissions and there may be an increase in background noise when messages are received. You may still be out of range even though you can hear a message. The reason for this is that the signal you are receiving is usually transmitted at a higher power level than the one transmitted by your radio. Communication may be improved by moving to higher ground or away from shielding objects such as tall buildings or hills.

7.6 Licensing

A government license is usually required to operate this radio on the air.

7.7 Radio Service

If the radio is not responding to any key presses, the keypad may be locked. Refer to Section 3.6 for more information.

If “Password” is briefly displayed when power is turned on and you are prompted to enter a password, the Power-Up Password feature is enabled. Refer to Section 3.2 for more information.

If “Unprogramd” is displayed, the cause could be any of the following:

- An unprogrammed channel is selected. Select a programmed channel.
- The selected channel is programmed for an option that is not installed or an error in programming was detected. Reprogram the radio.

If no characters appear in the display, the battery may be discharged or defective. Try another battery. If some other problem is occurring, turn power off and then on again to reset the control logic. Also make sure that the controls are properly set. If it still does not operate correctly, return it for service.

Note *There are no user-serviceable components in the radio. Altering internal adjustments can cause illegal emissions, void the warranty, and result in improper operation that can seriously damage the radio.*

Determining Available Options

This manual describes the operation of all features that are currently available for the 51xx ES radio. However, many of these features are optional and therefore may not be available in your radio. For example, Project 25 trunked operation is optional and may not be available. Model III radios have the DTMF keypad, but the Model II radios do not have this feature.

Availability of optional features is controlled by factory programming of the control logic. Only those features that are specifically ordered and enabled in a particular radio are available for use and can be programmed. The features controlled by factory programming are as follows:

P25 Options

- P25 conventional data
- P25 trunked data
- P25 conventional operation
- P25 trunked operation

Encryption Options

- DES
- DES-OFB
- AES

OTAR Options

- OTAR P25 conventional
- OTAR P25 trunked

Trunking Options

- SMARTNET analog operation
- SmartZone analog operation

- Digital SMARTNET/SmartZone

Feature Options

- Keypad programming (Federal Government users only)
- 512 channels/talk groups (51xx ES, currently standard)
- DTMF Keypad support
- Zonefail site lock

Currently, the only operating mode that is standard with all models is the conventional analog mode. Other variables such as frequency range are hardware dependent instead of software dependent.

8.1 Upgrading A Radio With New Options

The capability exists to upgrade radios in the field with new features. A new feature can be purchased and a special encrypted code string keyed to the ESN (Electronic Serial Number) of the radio is then provided by the EFJohnson Company. This string is in the form of a computer file, and is downloaded to the radio using the PC Configure programming software. This is initiated by clicking the “Update Options” button on the **Radio Options** screen shown in Figure 8.1.

Figure 8.1 PC Configure Radio Options Screen

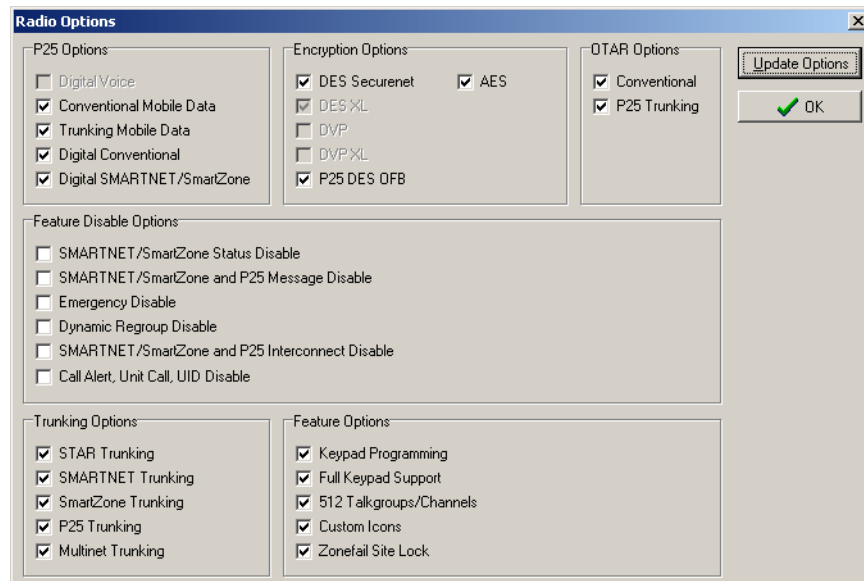

8.2 Using PC Configure To Determine Options

To determine what software options have been enabled in a particular radio, it is recommended that you use the PC Configure™ programming software to read and display what options are installed. Proceed as follows:

- 1 Connect the computer to the radio and start the program as described in the documentation included with the PC Configure software.
- 2 Select the 51xx ES radio type by selecting menu parameter **Radio > Series > 5100 Portable**.
- 3 To display the Radio Options screen shown in Figure 8.1, select **Transfer > Read Options From Radio**.
- 4 The check boxes indicate which options are enabled in the radio. They are for informational purposes only and cannot be edited.

Examples

The following are examples of items that need to be checked to program various optional features:

P25 Conventional Operation with DES Encryption and OTAR

- P25 Options - Digital Conventional, Conventional Radio Data
- Encryption Options - P25 DES OFB
- OTAR Options - Conventional

P25 Trunked Operation with DES Encryption

- P25 Options - Digital Conventional
- Encryption Options - P25 DES OFB
- Trunking Options - P25 Trunking

SMARTNET Analog and Digital Operation with Encryption

- P25 Options - Digital SMARTNET/SmartZone
- Encryption Options - DES-OFB
- Trunking Options - SMARTNET Trunking

Note *The “Feature Disable Options” are currently not used, so those features are always available.*

Determining Available Options

Password Description

The following passwords may be set:

- Four Power-On (User x) Passwords
- Download and Upload Passwords
- Master Password

9.1 Programming Passwords

Passwords are programmed using a password management screen displayed by the **Tools > Password Management** menu. The applicable radio must be connected to the computer and powered up to display this screen.

Password data is transferred and stored in an encrypted format for security purposes. In addition, actual passwords are never displayed. They are always indicated by eight asterisks (*****). Therefore, it is not possible to determine what passwords are in a radio using the PC Configure software.

Passwords must be 1-8 characters in length and consist of the numbers 0-9. Zeros are valid characters in any location, even as leading characters. Initially, all passwords are null (deleted) characters. Therefore, when initially programming a password, no entry is required in the “Original/Master Password” box.

9.1.1 Lost Passwords

If a password is lost, it can be changed using PC Configure by entering the Master password (see following). If even the Master password is lost or was not used, all passwords can be erased using the PCTune software as follows:

- 1 With PCTune 1.1.1.0 or later, select **Radio > Reset Passwords**. Only password information is erased.
- 2 With earlier versions of PCTune, after starting the PCTune program, press **SHIFT <CTRL> E** to toggle the following Erase EEPROM function (otherwise it is grayed and not selectable). Then select **Radio > Erase EEPROM > Params Only**. All password and personality information is erased, so the radio must be reprogrammed.

Note *Do not select “Complete” because that erases all information and the radio must then be sent back to the factory to make it usable again.*

9.1.2 Changing Password

An assigned password can be changed by the user if the “Set User Password” option switch or menu parameter (5100 ES) is programmed. Selecting this function displays prompts for entering and confirming a new password.

Note *With the 5100 ES portable, it is recommended that a number key not be used for this function because the password mode is exited if that key is pressed to enter a number.*

9.1.3 Password Entry Procedure

Whenever a password is requested, it is entered as follows:

With DTMF keypad models, enter each number using the keypad and press the **<F2>** (Enter) key after the last digit is entered. With limited keypad models, enter each number by pressing the Up/Down switch and press the **<F2>** key after each digit.

9.2 Password Description

9.2.1 User (Power-On) Passwords

When a User Password is enabled, it must be entered each time radio power is turned on. Up to four different User Passwords (User 1/User 2/User 3/User 4) can be programmed. Currently, the same radio features are enabled for each. Entering any User Password at power up enables normal radio operation.

9.2.2 Download/Upload Passwords

Separate Download (write) and Upload (read) passwords can be programmed to prevent unauthorized downloading or uploading of radio programming parameters. When one or both of these passwords are used, the proper password must be entered to perform the operation. A “User” password is not required to upload or download parameters.

9.2.3 Master Password

The Master Password overrides all the preceding passwords. It can be used by a system administrator as a “pass key” to a password controlled function or to change a lost or inadvertently changed password. Master passwords are set up and changed the same as the other passwords. It does not override the following Zone Password.

9.3 Zone Password

Note *The programming and usage of this password is independent from the preceding passwords, and programmed in the **Zone > Edit Zones and Channels** screen.*

A zone password can be programmed with the 51xx ES portable. It prevents unauthorized reprogramming of zones by keypad programming. When this password is used, it must be entered before system or channel parameters in that zone can be changed. The zone password is programmed in the **Edit Zones and Channels** screen. This screen is displayed by clicking the **Edit Zone** button on the **Zone** screen.

A different password can be programmed for each zone. When a password protected zone is selected, “Password” is flashed the first time an attempt is made to select a system or channel parameter in that zone. Each digit of the password is then entered as previously described. The password is always eight digits long, and after the eighth digit is entered, system and channel parameters for that zone can be reprogrammed normally.

Password Description

SECTION 10

Secure Communication (Encryption)

This radio may be equipped to provide secure communication on some or all channels. This feature encrypts the voice so that it can be understood only by someone using a radio equipped with a similar encryption device and encryption codes.

When a secure call is received, the LED flashes Red and  is indicated in the display. If equipped with the Clear/Secure option switch and the current channel is programmed to allow switch selection, secure communication can be manually enabled and disabled by that switch. Otherwise, channels are strapped to Clear or Coded operation (see Section 10.3). Secure communication can be programmed on a per channel or per talk group basis to operate in various ways. More information follows.

10.1 Encryption Algorithms

10.1.1 SecureNet™

SecureNet encryption digitizes the voice and then encrypts it using the DES algorithm. It uses a 64-bit encryption key. The SecureNet protocols include the following algorithms:

- DES (Data Encryption Standard) provides a level of security, and also uses cipher feedback. It was originally designed to be used only by the Federal government.
- DES-OFB - A form of DES encryption for digital channels that uses output feedback. This protocol does not result in the degraded range that occurs with analog channels.

10.1.2 AES (Advanced Encryption Standard)

A new encryption standard called AES is replacing DES-OFB encryption on digital (P25) channels. It uses a 128-, 192-, or 256-bit encryption key instead of the 64-bit key used with DES. EFJohnson radios currently support only 256-bit AES keys. The type of encryption (DES or AES) is determined by the type of encryption key that is loaded (see Section 10.2), and not by the PC Configure programming software. AES encryption, like DES encryption, is an optional radio feature that must be purchased and then enabled at the factory.

Note *The 51SL ES Series radios do not support AES encryption.*

10.1.3 Encryption Available With Various Channel Types

Analog Channels - On analog conventional and SMARTNET/SmartZone channels, DES encryption provides secure communication.

Digital Channels - On digital Project 25 and SMARTNET/Smart Zone channels, the DES-OFB or AES-OFB protocol is used.

10.1.4 FIPS and Non-FIPS Modes

FIPS 140-2 is a Federal Information Processing Standard for encrypted radios used by the Federal Government. This standard specifies Federal security requirements for cryptographic modules for a wide range of applications and environments.

10.2 Encryption Keys

An encryption key is a cryptographic variable that is required by the encryption algorithm to encrypt and decrypt voice or data. To maintain system security, these keys must be protected from disclosure and also periodically replaced or updated.

With the AES and DES encryption used by EFJohnson radios (see Section 10.1), the same encryption key is used by both the encrypting (sending) and decrypting (receiving) radio. AES encryption keys are generated from a string of 64 hexadecimal characters, and DES keys are generated from a string of 16 hexadecimal characters. Another four hexadecimal characters are used to specify the key ID. Multiple keys can be loaded into a radio using OTAR or manual loading.

When an encrypted message is transmitted, the encryption Algorithm ID (ALID) and key ID (KID) are usually included in the message. This tells the receiving radio which key and algorithm must be used to decrypt the message.

If an attempt is made to transmit a secure message without loading the corresponding key, “Keyfail” is displayed. The message must then be transmitted in the clear mode (this is possible only if the channel is strapped to “switchable”) or the key must be loaded.

10.2.1 Key and Algorithm IDs

Each encryption key is programmed with a Key ID (also called Logical ID). This ID plus the algorithm ID (ALGID) is transmitted in the message on digital channels. The radio receiving the message must have a key with the same IDs in order to decrypt it.

10.2.2 PID/SLN Key Management Modes

Note The term “SLN” from the Project 25 specification is equivalent to “CKR” (Common Key Reference) also used to define this parameter.

The channels, talk groups, and other calls that use encryption are linked to a specific Physical ID (PID) when the radio is programmed using the PC Configure programming software. For example, Zone 1, channel 1 could be programmed to select the key in PID 1 and Zone 1, channel 2 could select the key in PID 3. The PID ranges are 0-15 when the PID mode is selected, and 1-16 when the SLN mode is selected (see Figure 10.1).

Figure 10.1 Key Selection Example

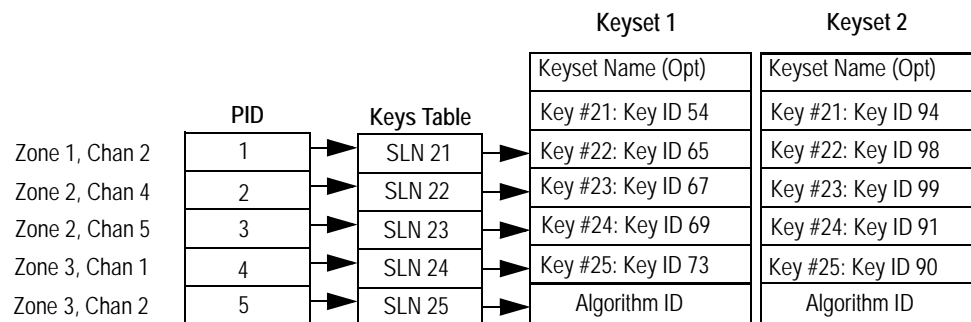

PID or SLN key management modes can be programmed on the Global programming screen. More information on these modes follows.

PID Mode - The PID mode can be used only when keys are loaded using the Motorola KVL 3000 keyloader operating in ASN mode. When this mode is selected, keys are loaded directly into a PID of 0-15 that corresponds to the PID programmed for each channel (if applicable). The Keys Table in PC Configure is not programmed with this mode.

SLN Mode - The SLN mode must be selected when either OTAR (Over-The-Air-Rekeying) or the EFJohnson System Management Assistant (PDA keyloader) or the Motorola KVL 3000 keyloader operating in Astro 25 mode is used. It can also be used if OTAR is not used. With this mode, keys are loaded into a SLN (Storage Location

Number), typically from 0-4095. A Keys Table must then be programmed to link channel PIDs to a specific SLN.

The use of this type of indirect linking allows keysets and key IDs to be changed via OTAR while keeping the mapping from the channel or talk group the same. For example, as shown in Figure 10.1, PID 4 selects SLN 24 which selects key slot 24 in both keysets. This slot contains Key ID 69 in Keyset 1 and Key ID 91 in Keyset 2. Only one keyset is active at a time. The actual key chosen between these two to transmit with will depend on which keyset is active, Keyset 1 or Keyset2.

10.2.3 Maintaining Keys in Memory

The radio may need to be connected to a constant power source to preserve the encryption keys in memory. The programming of the Infinite Key Retention parameter determines if keys are permanently stored in memory or erased soon after power is removed.

When Infinite Key Retention is enabled, keys are stored in memory and are not lost when power is removed. If it is disabled, they are maintained only until the storage capacitance discharges. With 5100 ES models, storage capacitors maintain the supply voltage (and encryption keys) for approximately 30 seconds without power applied. Therefore, when changing the battery, make sure to reattach another within 30 seconds.

10.2.4 Encryption Key Select

Note *This feature is available on conventional channels only.*

When multiple encryption keys are programmed (see preceding information), the Key Select option switch can be programmed to allow selection of another key for the current channel. This feature changes the PID (hardware location) of the key, and the change is permanent (cycling power or selecting a different channel does not reselect the original key). Therefore, to switch back to the original key, it must be manually reselected. Proceed as follows to select a key:

- 1 Press the Key Select switch or select that menu parameter.
- 2 Press the Up/Down switch to display the desired key and then press the <F2> (Select) key to select it. Press the Key Select switch again to return the display to normal operation.

10.2.5 Encryption Key Erase

A Key Erase menu item can be programmed that allows the user to permanently erase all stored keys. If OTAR TEK and KEK keys are stored, all keys of both types are erased. This function can be used to ensure that unauthorized encrypted calls can no longer be placed or received by a radio.

10.2.6 Encryption Icon Operation

Basically, the encryption icon  is on continuously whenever a secure call is received or transmitted. Other operation is as follows:

- When a secure call is received on a digital channel in either the secure or clear mode, this icon flashes.
- When a clear call is received on a digital channel in the secure mode, this icon is on continuously.
- There is a programmable option on the Radio Wide screen to sound a beep whenever a secure call is received on a clear channel.

10.3 Clear/Secure Strapping

10.3.1 Transmit Mode Options

The following transmit options are available when encryption is selected:

“Clear” - All calls are in the clear mode unless responding to a secure call. If the response is then made within the delay time, it occurs in the secure mode.

“Secure” - All calls are made in the selected secure mode.

“Switched” - The mode is selected by the Clear/Secure switch. When the clear mode is selected by this switch and a secure call is received, or vice versa, you will hear a beep. Press the programmed option button to change to the appropriate mode.

If the channel has been strapped “Clear” and the option switch selects the “Secure” mode on power up and a transmission is attempted, transmitting is disabled. Likewise, if the channel is strapped “Secure” and the option switch selects the “Clear” mode on power up and a transmission is attempted, the transmitter is disabled.

The radio can be programmed to ignore the “Clear” or “Secure” switch setting (“Ignore Clear/Secure Switch When Strapped” selected on **Global** screen). These preceding indications then do not occur and transmissions always occur in the strapped mode.

Note *If all channels/talk groups are strapped clear or secure and no Clear/Secure option switch or menu parameter is programmed, this parameter must always be selected (see following).*

If the Clear/Secure switch or menu parameter are not programmed, the radio is always in the last known state (usually Clear) and there is no way to change it. For example, if the last known state is Clear and this parameter is not selected, it is never possible to transmit a Secure message on a channel strapped Secure. An error tone sounds.

10.3.2 Receive Mode Options

The following receive options can be programmed with conventional operation. With SMARTNET/SmartZone and P25 Trunked operation, encrypted calls are received if the proper key is programmed.

No Autodetect - Only signals coded like the transmit signals are received.

Secure Autodetect - Both clear and secure signals are automatically detected. This mode is automatically selected if the transmit mode is switch selectable.

Proper Key Autodetect

Analog Channels - When this feature is disabled and a message is received with the wrong key, the audio unmutes and garbled (encrypted) audio is heard. However, if this occurs with this feature enabled, the audio remains muted.

10.3.3 Talk Group Encryption Override

On conventional digital (P25) channels, the encryption strapping mode and PID are programmed on a per talk group basis similar to the trunked modes (SMARTNET/SmartZone/P25 Trunked). However, with this mode only, there is the option to override the talk group encryption programming and program it on a per channel basis. Therefore, if desired on conventional digital channels, encryption can be programmed differently for each channel. Conventional analog channel encryption is always programmed on a per channel basis.

10.4 OTAR (Over-The-Air Rekeying)

OTAR stands for “Over-The Air-Rekeying”. This is the process of sending encryption keys and related key management messages over-the-air to specific radios. The advantage of OTAR is that it allows these keys to be quickly and conveniently updated when necessary. It is no longer necessary to periodically travel to the radio location or bring the radio into a maintenance facility to load new keys.

The actual OTAR rekeying functions are performed by a Key Management Facility (KMF) that sends Key Management Messages (KMM) to the radios. These messages are themselves encrypted using an encryption key. Radios must be OTAR-compatible and programmed for OTAR for this type of rekeying to occur.

OTAR is available only on P25 conventional and trunked channels, and only to program DES-OFB and AES keys. It is not used on SMARTNET/SmartZone channels.

10.4.1 Encryption Key Types

There are two types of keys used with OTAR:

TEK (Traffic Encryption Key) - The key used to encrypt voice and data traffic. All radios using encryption must have at least one of these keys.

KEK (Key Encryption Key) - The key used to encrypt keys contained in OTAR Key Management Messages (KMMs). All radios which use OTAR must contain at least one of these keys. The KEK used to decrypt/encrypt keys in an OTAR message is defined by the algorithm and key IDs transmitted in the decryption instructions field. A KEK may be unique to a particular radio (UKEK) or common to a group of radios (CKEK).

10.4.2 Keysets

A keyset is simply a set of one or more keys of the same type (either TEK or KEK). Keysets are identified by Keyset IDs.

The KEK keyset is considered always active and has ID 255. Two TEK keysets are normally used, and one is always active and the other inactive. This allows the inactive keyset to be replaced without interrupting operation. One is Keyset ID 1 and the other Keyset ID 2. With EFJohnson radios, each keyset can contain up to 128 keys, but less than 16 are normally used for optimum keying efficiency and because only up to 16 can be selected by the radio.

The active keyset is usually selected by the Key Management Facility. It can also be selected by the keyloader function of the EFJohnson SMA (Subscriber Management Assistant) or by the user if the Change Keyset option switch or menu parameter is programmed. Automatic keyset changeovers are not supported by EFJohnson radios. In the SLN mode (see Section 10.2.2), two TEK keysets can be used if desired even if OTAR is not used.

A diagram of a keyset is shown in Figure 10.2. Some information may be optional as shown.

Figure 10.2 Keyset Diagram

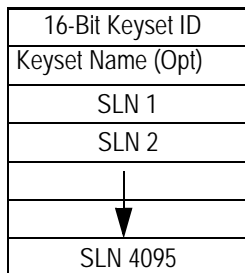

10.4.3 Key Management Facility

The Key Management Facility (KMF) provides key management and OTAR functions to applicable radios within the radio system. One of the main tasks of the KMF is to maintain a data base of encryption information contained in each radio. This information may include the following:

- TEKs (main Traffic Encryption Keys)
- KEKs (Key Encryption Keys) used to encrypt keys within OTAR messages
- Keysets (groups of TEKs or KEKs)
- Individual and group Radio Set Identifiers (RSIs)

The KMF performs OTAR functions by exchanging Key Management Messages (KMMs) with the radios. Both the KMF and radio can originate messages. Some functions performed by the KMF are as follows:

- Loading new keys
- Modifying keys
- Initiating active keyset switchovers
- Modifying keyset names
- Deleting keys
- Deleting all keys (zeroize) when a radio may be lost or compromised
- Determining if a radio is on the air and reading key information
- Changing individual and group RSIs
- Manage Subscriber Groups (groups of radios using the same keys).

10.4.4 Message Number Period (MNP)

One of the parameters that is programmed in a radio utilizing OTAR is Message Number Period (MNP). This parameter is programmed as described in Section 10.5.2. This parameter is used to minimize the possibility of someone sending messages to “spoof” the system or radio. The MNP is used as follows.

Every message sent out has a message number. The message number increments by one with each message sent. The MNP is the maximum difference allowed between messages. For example, if the MNP is set to 1000 and the last message number received by the radio is older by more than 1000 from the current message number, the current message is ignored, and a message number resynchronization process will be automatically attempted. If the MNP is set to 65535, message numbers are ignored.

When determining this number, consider the likelihood of someone trying to spoof the system by retransmitting recorded messages and then adjust the MNP accordingly. The higher the risk, the smaller the MNP should be. A disadvantage of setting a low MNP is that the chance of rejecting valid messages becomes higher. In addition, traffic level and terrain contribute to lost messages and should also be considered when selecting this number. If the message numbers become out-of-sync between the radio and the KMF, an automatic resynchronization process will take place, which requires additional bandwidth. Note that this process is not possible if the radio does not share a TEK with the KMF.

A setting of 1000 will block very old messages but is unlikely to affect anything intentionally sent out by the system (1000 messages sent to a single radio is not likely to occur in a system in less than a year with normal usage).

10.4.5 Definitions

Algorithm - Refers to the specific encryption standard (DES or AES) that is used to encrypt a message. Each standard uses different calculations to perform the encryption (see Section 10.1).

Algorithm ID (ALGID) - Identifies the algorithm (DES or AES) used to encrypt a message. This ID and the Key ID are transmitted with each non-analog message to uniquely identify the key being used.

Black - Refers to information that is encrypted. The opposite is “Red” which refers to unencrypted information.

Common Key Encryption Key (CKEK) - This is a KEK common to a group of subscriber units which share the same encryption. These keys can be the DES or AES type. The use of a common key allows the subscriber units to be rekeyed by the KMF using one Key Management Message in some circumstances by addressing the KMM to a group RSI. Refer to “KEK” for more information.

Common Key Reference (CKR) - Same as Storage Location Number (SLN).

Crypto Group - A group of up to 16 keysets containing the same type of keys (either TEK or KEK). Although a crypto group can contain up to 16 keysets, only two are normally used. Only one keyset in a crypto group is active at a time. EFJohnson radios currently support only one crypto group for TEKs, crypto group 0.

Cryptographic Variable - The variable used by a cryptographic algorithm to encrypt a message. Also called a “key”.

Key - A variable used by a cryptographic algorithm to encrypt voice or data. Also called “Cryptographic Variable”. Keys are identified by their Algorithm ID and Key ID values.

Key Encryption Key (KEK) - A key used to encrypt keys contained in Key Management Messages (KMMs) during OTAR. These messages may themselves be encrypted by a TEK. These keys can be the AES or DES type. There are KEKs unique to a subscriber unit (UKEK) and common to a group (CKEK). The other type of key is the Traffic Encryption Key (TEK) used to encrypt voice and data messages.

Key ID - This is a 16-bit (four hex digit) number identifier from 1-65535 for an encryption key which allows the key to be identified without revealing the actual key variable. This ID and the Algorithm ID uniquely identify a key within the KMF or subscriber unit. Therefore, two keys can have the same ID if they have different algorithm IDs and vice versa. The Key ID and Algorithm ID are usually transmitted with a message to identify the key that must be used to decrypt it. Key ID 0 is not used with OTAR.

Key Management Facility (KMF) - The equipment and software which provide OTAR and related key management services to the subscriber units.

Key Management Message (KMM) - These are the messages composed by the KMF to send encryption information to subscriber units via the keyloader or OTAR. KMMs are themselves encrypted using two layers of encryption: inner and outer. The inner layer of encryption uses a KEK and the outer layer uses a TEK. Additional security measures contained within KMMs include a Message Number (MN) and a Message Authentication Code (MAC).

Keyset - A structure containing keys of the same type (TEK or KEK). There are two TEK keysets, Keyset 1 and Keyset 2, and one KEK keyset, Keyset 255. Only one of the two TEK keysets is active at a given time. This provides a way to divide the two keys contained within each SLN into two groups, active keys and inactive keys, based on the currently active keyset setting.

Keyset Changeover - The process used to switch the active keyset setting on a subscriber unit to the currently inactive keyset so that the keys in the newly inactive keyset can be replaced without interrupting encrypted communication.

Key Loader - Any type of device used to load encryption keys into a radio. With OTAR, this device must be used to provide the initial key loading of a subscriber unit so that it contains the basic keys needed for OTAR by the KMF (the KEK). If OTAR is not utilized, is always used to load encryption keys. EFJohnson offers a PDA-based keyloader.

Logical Link ID (LLID) - An ID transmitted with a CAI data message to identify the destination of the message.

Message Number Period (MNP) - The maximum difference between message numbers that can occur before a message is declared invalid (see Section 10.4.4).

Over-The-Air-Rekeying (OTAR) - The process of sending new encryption keys over the air using an RF interface.

Red - Refers to information that is not encrypted. The opposite is “Black”.

Rekey - The process of preparing, sending, and loading encryption keys into a subscriber unit for current or future use. This may be done over-the-air (OTAR) or by directly connecting a keyloader to the subscriber unit.

Radio Set Identifier (RSI) - Subscriber units are programmed with one or two Radio Set Identifier (RSI) numbers that identify the unit for OTAR purposes. The RSI can be unique to an individual subscriber unit or unique to a group of subscriber units. An individual (unit) RSI is always assigned and a group RSIs may be assigned. The individual RSI is typically programmed when the subscriber unit is initially brought into service. The KMF is also identified by an RSI (KMFRSI) to use as the destination of any KMMs a subscriber unit originates. The KMMs (Key Management Messages) generated by the KMF (Key Management Facility) are addressed to a specific RSI.

Storage Location Number (SLN) - A link to a specific TEK in a given keyset. A given SLN can contain two keys, one for the active keyset and one for the inactive keyset. SLNs and CKRs are equivalent terms (see Section 10.2).

Traffic Encryption Key (TEK) - A key used to encrypt voice or data. The other type of key is the Key Encryption Key (KEK) which is used to encrypt keys contained in Key Management Messages. TEKs can be either the AES or DES type.

Unique Key Encryption Key (UKEK) - A KEK unique to a particular subscriber unit. Refer to “KEK” for more information. These keys can be either the AES or DES type.

Zeroize - The process of deleting all keys from a compromised subscriber unit to disable it. To make the unit encryptionally functional again, the keys must be reloaded by a keyloader.

10.5 Radio Setup For Encryption

10.5.1 General Encryption Setup

The following radio setup is required for encryption regardless of whether OTAR is used:

Options Enabled - The desired encryption type must have been enabled at the factory (DES, DES-OFB, AES-OFB). To determine what options are enabled, using the PC Configure programming software, select the **Transfer > Read Options From Radio** menu parameter.

PC Configure Programming

PID/SLN Mode - On the **Global** screen, select either the PID or SLN mode (see Section 10.2.2). If the SLN mode is used, also program the Keys Table by clicking the  button.

Infinite Key Retention - On the **Global** screen, select this parameter to store keys permanently in memory (see Section 10.2.3).

Erase Keys On Keypad Change - On the **Global** screen, if the SLN mode is selected and more than one keypad is used (see Section 10.4.2), select this parameter to erase keys in the currently active keypad before activating the currently inactive keypad. (see Section 10.2.5).

Program Channel/Group PIDs and Encryption Type - With conventional analog calls, this information is programmed on the channel screen. With other types, it is programmed in the talk group list selected on the system screen. In addition, with conventional digital calls, the group programming can be overridden on the channel screen (see Section 10.3.3). Additional PIDs for special calls can also be specified on the system screen for digital and trunked calls.

Note *The encryption type is not selectable on digital channels because the AES/DES mode is determined by the key type loaded, not by PC Configure programming.*

Currently, EFJohnson 51xx ES portables that meet the following requirements support OTAR:

Software Version Number - The 51xx ES must have firmware (operating software) version number 6.x.x or higher. It can also be determined using the PC Configure programming software by selecting the **Transfer > Read Version Info from Radio** menu parameter.

Programming - An RSI and UKEK and other information must be programmed as described in the next section.

10.5.2 Additional Setup For OTAR

10.5.2.1 Additional PC Configure Programming For OTAR

The following parameters must be programmed for OTAR operation in addition to those in Section 10.5.1 (PC Configure Version 2.1.0 or later is required).

- 1 On the **Radio Wide** Conventional screen, program the Digital Unit ID.

- 2 On the **Global** screen, Page 2, set the Unit RSI ID as desired (normally this ID is initially the same as the Digital Unit ID). It can be changed later by the KMF or keyloader if desired. Note these two IDs.
- 3 On the **Per System** Conventional screen, Page 2, for OTAR and Data Settings, select OTAR Enabled = On and Data Registration Enabled = On. When data registration is enabled, the radio registers with the data system on a channel change.
- 4 Also on this screen, set the other OTAR and Data parameters. The OTAR Rekey Request Time Out determines how long the radio waits for the OTAR Rekey procedure to finish before determining that it failed. Times of 20-180 seconds can be programmed, and the default is 60 seconds. Refer to the PC Configure software manual and Help for more information on these parameters.

10.5.2.2 Motorola Third-Party RNC Registration

The 51xx ES portable supports Motorola dynamic data registration. However, if desired, the radio can be programmed to perform MOT 3rd Party data registration instead of dynamic registration on the OTAR and Data parameters page. If MOT 3rd Party registration is selected, the radio must be manually registered on the Motorola RNC Console by entering the following command:

```
LCRD 03 06 00 1234 7F xx xx xx 0A 0A 00 07 00 yy
```

Where, “xx xx xx” is the hex value of the Digital Unit ID entered by the PC Configure software. Refer to the console documentation for the value of “yy” or use “00”. This registration needs to be done only once.

10.5.3 Programming By Keyloader

The following are the minimum parameters that need to be programmed in the radio to perform OTAR. It is not necessary to program a TEK to perform OTAR. If the radio does not contain a TEK, the KMF initiates a warm start sequence in which a temporary TEK is transferred to the radio to perform the key transfer.

UKEK - This key normally has SLN (CKR) 61440 and Key ID 62880 (F5A0 hex). Create a key (either AES or DES type as required) and download it to the radio. AES UKEKs typically use an SLN of 61442 and a Key ID of 62880 (0xF5A0).

Unit RSI - This is normally initially the same as the P25 Unit ID and is programmed by the PC Configure software as described in Section 10.5.2.1. Therefore, the RSI should not need to be loaded if it is the first time the radio is being set up for OTAR or if the radio dumps keys due to long-term battery disconnect. However, it may need to be loaded if the radio is manually deleted from the KMF and then recreated since the message number must be reset to 0 (the Load Target RSI command resets the message number to 0).

KMF RSI - This RSI is normally 9,999,999 and should not need to be loaded since it defaults to this number.

MNP (Message Number Period) - Load the proper message number period into the radio (typically 1000). Refer to Section 10.4.4 for more information.

Verify that the above information was properly stored in the radio by viewing it using the keyloader.

10.6 Radio OTAR Capabilities

10.6.1 SEM 5100 ES

The OTAR capabilities of the SEM equipped 5100 ES portable are as follows.

- Keysets
 - Up to three keysets are used and it is assumed all three are always present. Keyset IDs 1 and 2 are for TEKs and only one is active at a time. Keyset ID 255 is for KEKs and is considered active all the time
 - Each keyset can have up to 128 keys. However, 16 or less are normally used.
- RSI (Radio Set Identifier)
 - One individual RSI and it is usually initially the same as the P25 Unit ID.
 - One group RSI (usually initially “0”).
 - One KMF RSI (usually always 9,999,999).

10.6.2 OTAR Messages That Are Supported

The following KMM Message IDs are recognized by or sent:

CHANGE RSI	0x03
CHANGE RSI RESPONSE	0x04
KEYSET CHANGEOVER	0x05
KEYSET CHANGEOVER RESPONSE	0x06
DELAYED ACK	0x07
HELLO	0x0C
INVENTORY	0x0D
INVENTORY RESPONSE	0x0E
MODIFY KEY	0x13
MODIFY KEYSET ATTRIBUTES	0x14
MODIFY KEYSET ATTRIBUTES RESPONSE	0x15

NEGATIVE ACK	0x16
NO SERVICE	0x17
REKEY ACK	0x1D
OTAR REGISTRATION	0x25
OTAR REGISTRATION RESPONSE	0x26
REKEY	0x1E
UNABLE TO DECRYPT	0x27
WARM START	0x20
ZEROIZE	0x21
ZEROIZE RESPONSE	0x22

10.6.3 OTAR Option Switches

The following additional option switches can be programmed with the 5100 ES portable to control OTAR functions. They are also available as 5100 ES menu parameters unless noted otherwise.

Change Keypad - Toggles the active keypad between Keypad 1 and Keypad 2. The new active keypad is briefly displayed and then normal operation resumes. When the 5100 ES menu is used, the current active keypad is indicated by an asterisk. To change to the other keypad, highlight it and press the <F2> key.

Clear/Secure Select - This enables and disables encryption regardless of whether OTAR is used. Refer to Section 10.3 for more information.

Erase Keys - Erases all TEK and KEK keys contained in the radio. With the 5100 ES, this function is available as menu parameter only.

Key Select - This allows a different key to be selected for the current channel or group (conventional channels only). Refer to Section 10.2.4 for more information.

10.6.4 Additional Functions Selectable by 5100 ES Menu

To select a parameter, highlight it and press <F2>.

Rekey - Performs the same function as the OTAR Rekey Request option switch described in the preceding section.

Need KEK - Sends a request for a new Key Encryption Key (KEK). Upon receiving this message, the KMF marks the radio as requiring service. One time this function may be selected is if the radio dumps its keys.

Identify - Sends a message which tells the KMF that the radio is on the air. Currently, the KMF will usually either echo the message back to the radio or respond with a No Service KMM. This function can be used to test communication without initiating the rekeying that occurs with the preceding “Rekey” function.

Erase Keys - Erases all keys in the radio the same as the Erase Keys option switch described in the preceding section.

Index

- A**
- Accessory Connector 2-5
 - AES Encryption 10-2
 - Alert Tones 4-5
 - Algorithm 10-9
 - Algorithm ID 10-9
 - Analog and Digital Operation 6-1
 - ANI Signaling 5-13
 - Antenna Connector 2-4
 - Autodetect 10-6
- B**
- Backlight 3-11
 - Battery 2-4
 - Battery Charging 3-9
 - Battery Saver Feature 3-9
 - Black 10-9
 - Busy Indicator 5-2
 - Busy Override 6-15
- C**
- Call Alert 6-8
 - Call Alert (P25 Conv) 5-20
 - Call Guard Squelch 5-3
 - Channel Select 3-5
 - Channel Switch 2-4
 - Channels 3-15
 - CKEK 10-9
 - CKR 10-9
 - Clear/Secure Strapping 10-5
 - Clone Feature 5-14
 - Combined Zone/Channel 3-7
 - Conventional Mode 3-13
 - Conversation Timer 5-6
 - Crypto Graphic Variable 10-10
 - Crypto Group 10-10
 - CTCSS/DCS Signaling 5-3
- D**
- Delay, Scan Resume 4-7
 - DES-OFB 10-1
 - Determining Available Options 8-3
 - Direct Channel Selection 3-5
 - Display 2-5
 - DTMF Keypad 2-2
 - Dynamic Regrouping 6-14
 - Dynamic Zone 3-7
- E**
- Emergency Alarms (Conv) 5-7
 - Emergency Alarms (SN/SZ) 6-11
 - Emergency Calls 6-12
 - Emergency Calls (Conv) 5-8
 - Emergency Hot Mic 5-9, 6-12
 - Emergency Man-Down 5-9, 6-13
 - Encryption 10-1
 - Encryption Key 10-2
 - Encryption Key Select 10-4
 - Encryption Keys 10-2
 - Enhanced Private Conversation Mode 6-3
 - Extended Range Operation 7-7
 - External Emergency Switch 5-9, 6-13
- F**
- F1 Key 2-2
 - F2 Key 2-2
 - F3, F4 2-2
 - Facility 10-8
 - Failsafe Operation 6-13
 - Features
 - Conventional 1-2
 - General 1-1
 - Project 25 5-16
 - Project 25 Trunked 1-3, 6-1
 - SMARTNET/SmartZone 1-3
 - SmartZone 6-15
 - FIPS 140-2 10-2
 - Five-Tone Signaling 5-14
 - Frequency Display 5-7
 - Front Display 2-2
- G**
- Group Calls 6-2
 - P25 5-16
 - Group ID Code 5-16
- H**
- Home Zone Select 4-4

Index (continued)

Hot Mic 5-9, 6-12

I

Indicator

 Priority Channel 5-11

 Top Panel 2-3

Individual Calls 5-17

Infinite Key Retention 3-9, 10-4

K

KEK 10-10

Key 10-10

Key Encryption Key 10-7

Key Erase Menu Parameter 10-5

Key ID 10-3, 10-10

Key Loader 10-10

Key Management Facility 10-8

Keypad Lock 3-11

 Permanent 3-11

Keypad Programming 5-22

Keypad Lock 3-11

Keypad Programming 5-22

Keypad Lock 3-11

Keypad Programming 5-22

Keypad Lock 3-11

Keypad Programming 5-22

Keypad Lock 3-11

Keypad Programming 5-22

Keypad Lock 3-11

Keypad Programming 5-22

Keypad Lock 3-11

Keypad Programming 5-22

Keypad Lock 3-11

Keypad Programming 5-22

Keypad Lock 3-11

Keypad Programming 5-22

Keypad Lock 3-11

Keypad Programming 5-22

Keypad Lock 3-11

Keypad Programming 5-22

Keypad Lock 3-11

Keypad Programming 5-22

Keypad Lock 3-11

Keypad Programming 5-22

Keypad Lock 3-11

Keypad Programming 5-22

Keypad Lock 3-11

Keypad Programming 5-22

Keypad Lock 3-11

Keypad Programming 5-22

Keypad Lock 3-11

Keypad Programming 5-22

Keypad Lock 3-11

Keypad Programming 5-22

Keypad Lock 3-11

Keypad Programming 5-22

Monitor Mode 5-2

Monitoring Before Transmitting 5-1

N

NAC 5-16

Network Access Code 5-16

Nuisance Channel Delete 4-8

O

On-Off/Volume Control 2-3

Operating Modes 3-12

Option Button

 Key Select 10-4

Option Switch 2-4

 Alert Tones 4-5

 Backlight 3-11

 Call Alert 5-20, 6-9

 Call Response 6-6

 Change Keypad 10-15

 Channel Select 3-5, 3-6

 Clear/Secure 6-2, 10-15

 Digital Talk Group Select 5-17

 Display Information 5-7

 Emergency 2-4, 5-8, 5-9, 6-11, 6-12

 Erase Keys 10-15

 High/Low Power 4-5

 Home 4-4

 Home2 4-4

 Key Select 10-4, 10-15

 Keypad Lock 3-11

 Keypad Programming 5-23

 Message 5-21, 6-10

 Monitor Mode 5-2

 Normal/Selective 5-4

 P25 Packet Data 5-22

 Phone 5-19, 6-7

 Priority Select 5-11

 Private Call 6-4, 6-5, 6-6

 Private Call (SmartNet) 6-4, 6-5, 6-9

 Radio Wide Scan 4-7

 Repeater Talk-Around 5-6

 RWS List Edit 4-11

 Scan 4-6

 Scan List Edit 4-10

 Scan List Select 4-9

 Selective Squelch 5-5

 Set User Password 3-4, 9-2

 Single Tone Encoder 5-13

 Site Lock 6-16

Index (continued)

Site Search	6-16
Squelch Select List	5-5
Status	5-21, 6-10
Surveillance Mode	4-6
Talk Group Select	5-17
Tone Volume	4-5
Unit Call	5-18, 5-20
Volume Up/Down	3-3
Option Switches	4-1
Option Upgrading	8-2
Optional Features	8-1
OTAR	10-11
OTAR Definitions	10-6
OTAR Messages Supported	10-14

P

P25 Packet Data	5-22
Paging	5-20, 6-8
Answering	6-8
Answering (Conv P25)	5-20
Initiating	5-20, 6-9
Password	
Changing	9-2
Download/Upload	9-1, 9-3
Master	9-1, 9-3
Operation	9-1
Power On	9-2
Power-Up	3-4
User	9-1, 9-2
Zone	9-3
Penalty Timer	5-6
PID Mode	10-3
Power On-Off	3-1
Power Output Select	4-5
Power Up Sequence	3-1
Power-Up Password	3-4
Priority Channel	
Changing	5-11
Priority Sampling	
Conv	5-10
P25 Trunked	6-14
SMARTNET/SmartZone	6-14
Programming	7-7
Project 25	
Group ID Code	5-16
Unit Calls	5-17
Unit ID	5-16
Project 25 Mode	3-14, 5-16
PTT ID	6-3
PTT Switch	2-4

R

Radio Options Screen	8-2
Radio Set Identifier	10-11
Radio Wide Mode Scan List	4-11
Radio Wide Scan	4-7
Receive Only	3-12
Red	10-11
Rekey	10-11
Repeater Talk-Around	5-6
Repeater Talkaround	5-7
RS-232 Port	5-22
RSI	10-11
RW Scan List	
Determining Channels in	4-11
Editing	4-11

S

Scan Hold Time	4-7
Scan List	4-9
Channel Delete	4-8
Determining Channels in	4-9
Editing	4-10
Selecting	4-9
Scanning	4-6
Conv	5-10
P25 Trunked	6-13
Priority	4-6
Radio Wide	4-7
SMARTNET/SmartZone	6-13
SecureNet	10-1
Servicing	7-7
Silent Mode	5-8
Single Tone Encoder	5-13
Site ID (SmartZone)	6-16
Site Locking/Unlocking	6-16
Site Trunking	6-15
Slave Radio	5-15
SLN Mode	10-3
SMARTNET/SmartZone Mode	3-13
Soft Power Down	3-2
Speaker	2-2
Speaking Into Microphone	7-7
Squelch Adjust	3-12
Squelch Code Select	5-5
Squelch Control	3-12
Standard Calls	
Placing (Conv)	5-12
Receiving (Conv)	5-12
Receiving (SMARTNET)	6-3
Standard Private Conversation Mode	6-3
Status Messages	5-21, 6-10

Index (continued)

Surveillance Mode 4-6
Systems 3-14

T

Talkaround Enable/Disable 5-7
TEK 10-11
Telephone Calls 6-6
Telephone Calls) 5-19, 6-7
TG on Rx 6-3
Time-Out Timer 4-4
Tone Select 4-5
Traffic Encryption Key 10-7, 10-11
Transmit Disable 3-12
Transmit Disable On Busy 5-3
Transmit Type 5-27
Transmitting in Scan Mode 4-8, 5-10
Troubleshooting 7-7

U

Unit Calls
 P25 5-17
Unit ID
 Project 25 Conv 5-16
Unit-To-Unit Calls 6-3
Up/Down Switch 2-2
User Group ID 6-3

V

Volume Adjust 3-1
Volume Control Disable 3-3
Volume Up/Down 3-3

W

Wireless Cloning 5-15

Z

Zeroize 10-11
Zone Lock 3-5
Zone Password 5-24, 9-3
Zone Select 2-4, 3-4
Zones 3-15

EFJohnson®

1440 Corporate Drive, Irving, TX 75038-2401
Phone: 972-819-0700, 1-800-328-3911 Fax: 972-819-0639
www.efjohnson.com

Printed in the U.S.A.

©Copyright 2006 EFJohnson
EFJohnson logo® is a trademark of EFJohnson.

Part of Part Number 002-5100-72000CD
December 2006