



*ASTRO[®]
XTS 5000[™]
Digital
Portable
Radio
Model II*

*User
Guide*



Preface

Before operating your radio, please review the “User Safety, Training, and General Information” section in the front of this user guide. Also, be sure to retain this publication for future reference.

Computer Software Copyrights

The Motorola products described in this manual may include copyrighted Motorola computer programs stored in semiconductor memories or other media. Laws in the United States and other countries preserve for Motorola certain exclusive rights for copyrighted computer programs, including, but not limited to, the exclusive right to copy or reproduce in any form the copyrighted computer program. Accordingly, any copyrighted Motorola computer programs contained in the Motorola products described in this manual may not be copied, reproduced, modified, reverse-engineered, or distributed in any manner without the express written permission of Motorola. Furthermore, the purchase of Motorola products shall not be deemed to grant either directly or by implication, estoppel, or otherwise, any license under the copyrights, patents or patent applications of Motorola, except for the normal non-exclusive license to use that arises by operation of law in the sale of a product.

ASTRO® Digital XTS 5000™ Model II Radio

Quick Reference Card

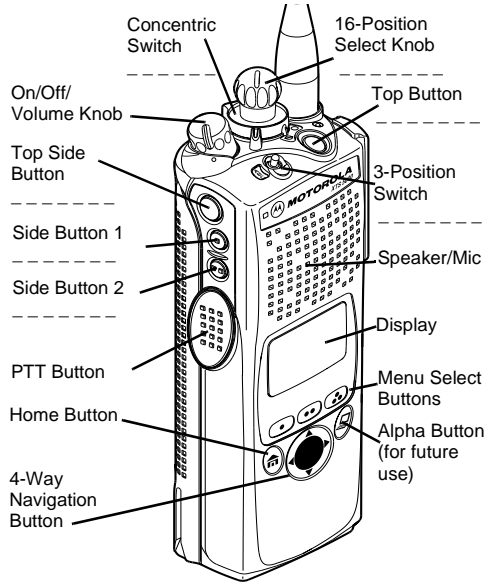

Write your radio's programmed features on the dotted lines.

Radio On/Off

- 1 On - **On/Off/Volume** knob clockwise.
- 2 Off - **On/Off/Volume** knob counterclockwise.

Zones/Channels

- 1 Zone - **Zone** switch to desired zone.
- 2 Channel - **Channel** switch to desired channel.

Receive/Transmit

- 1 Radio on and select zone/channel.
- 2 Listen for a transmission.
- or -
Press and hold **Volume Set** button.
- or -
Press **Monitor** button and listen for activity.
- 3 Adjust volume, if necessary.
- 4 Press **PTT** to transmit; release to receive.

Send Emergency Alarm

Radio on and press **Emergency** button. Display shows current zone/channel and **EMERGENCY**. Red LED lights; you hear short, medium-pitched tone.

Note: To exit emergency at any time, press and hold **Emergency** button.

When acknowledgment is received, you hear four beeps; alarm ends; radio exits emergency.











Send Emergency Call

- 1 Radio on and press **Emergency** button.
Note: To exit emergency at any time, press and hold **Emergency** button.
- 2 Press and hold **PTT**. Announce your emergency into the microphone.
- 3 Release **PTT** to end call.
- 4 Press and hold **Emergency** button to exit emergency.

Send Silent Emergency Alarm

- 1 Radio on and press **Emergency** button. Display does not change; you see no LED; you hear no tone.
Note: To exit emergency at any time, press and hold **Emergency** button.
- 2 Silent emergency continues until you:
 - Press and hold **Emergency** button to exit emergency state.
 - or -
 - Press and release **PTT** to exit silent emergency and enter regular emergency (alarm, call, or alarm with call).

Display Status Symbols

	Receiving an individual call
	The radio is in the view or program mode; On Steady = view mode; Flashing = program mode
	Received signal strength for the current site (trunking only). The more stripes in the symbol, the stronger the signal.
	Flashes when the battery is low.
	You are talking directly to another radio or through a repeater; On = direct; Off = repeater
	This channel is being monitored.
	Your radio is in secure operation; On = secure operation; Off = clear operation; Flashing = receiving an encrypted voice call
	The radio is scanning a scan list
	Priority 1 Channel during scan
	Priority 2 Channel during scan

Menu Entries (Use With Menu Navigation)

<i>Entry</i>	<i>Menu Selection</i>	<i>Page</i>
BATT	Smart Battery	15
CALL	Private Call	53
CHAN	Select a Channel	21
CLOCK	Set the Real Time Clock	75
DIR	Repeater/Direct	62
MUTE	Keypad Mute	29
PAGE	Call Alert Page	56
PHON	Phone	48
PROG	Editing	38

<i>Entry</i>	<i>Menu Selection</i>	<i>Page</i>
PWR	TX Power Level	27
RPGM	Reprogram Request	68
SCAN	Scan On/Off	44
SITE	Site Lock	72
STS	Status Call	60
TGRP	Talkgroup Call	58
VIEW	Viewing a List	37
ZONE	Zone	20

Menu Navigation

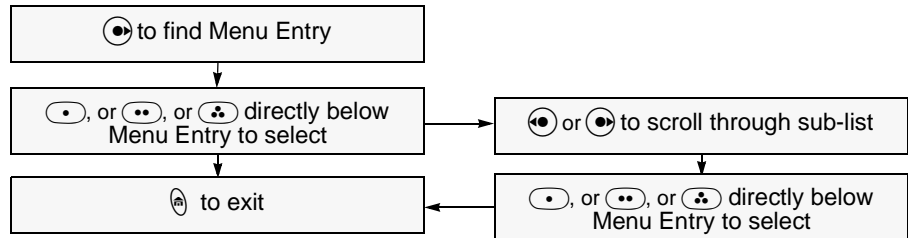

Contents

Preface	inside front cover
Computer Software Copyrights	inside front cover

User Safety, Training, and General Information . . . vii

Compliance with RF Energy Exposure Standards	vii
Operational Instructions and Training Guidelines	viii
Electromagnetic Interference/Compatibility	ix
Facilities	ix
Aircraft	ix
Medical Devices	x
Driver Safety	x
Operational Warnings	xi
Operational Cautions	xii
Intrinsically Safe Radio Information	xii
FMRC Approved Equipment	xii
Repair of FMRC Approved Products	xv

General Radio Operation 1

Notations Used in This Manual	1
Your XTS 5000 Model II Radio	2
Physical Features of the XTS 5000 Model II Radio	3
Programmable Controls	3
Display	4
Backlight	5
Status Symbols	5
Text	7
Menu Entry (Softkey)	7
Menu Select Buttons	7
Menu Entry Features	8
Home Button	8

Ⓜ, Motorola, ASTRO, ASTRO 25, XTS 5000, Private Conversation, and SmartZone are trademarks of Motorola, Inc.

P25 radios contain technology patented by Digital Voice Systems, Inc.

© 2001 by Motorola, Inc.
Commercial, Government and Industrial
Solutions Sector
8000 W. Sunrise Blvd., Ft. Lauderdale, FL 33322
Printed in U.S.A. 12/01. All Rights Reserved.

User Guide
68P81094C26-A

Contents

Alpha Button8
4-Way Navigation Button8
LED Indicators9
Alert Tones10
Standard Accessories13
 Battery13
 Smart Battery Condition15
 Antenna16
 Belt Clip17
 Universal Connector Cover18
Radio On and Off19
 Turn the Radio On19
 Turn the Radio Off19
Zones and Channels20
 Select a Zone20
 Select a Channel21
Receive / Transmit23
 Without Using the Volume Set and Monitor Buttons23
 Use the Preprogrammed Volume Set Button23
 Use the Preprogrammed Monitor Button24
 Conventional Mode Operation25

Common Radio Features 27

Selectable Power Level27
 Use the Menu27
 Use the Preprogrammed Transmit Power Level Switch28
Mute or Unmute Keypad Tones29
 Use the Menu29
 Use the Preprogrammed Keypad Mute Button29
Conventional Squelch Operation30
 Analog Options30
 Digital Options30
PL Defeat31
Time-out Timer32
Emergency33
 Send an Emergency Alarm33
 Send an Emergency Call34
 Send a Silent Emergency Alarm35
 Emergency Keep-Alive36

Lists	37
View a List	37
Scan List Empty	37
Edit a Scan List	38
Scan	43
Types of Scan Lists	43
Types of Scanning	43
Turn Scan On or Off	44
Delete a Nuisance Channel	45
Conventional Scan Only	46
Telephone Calls (ASTRO 25 Trunking Only)	47
Quick Access (One-Touch)	47
Answer a Phone Call	48
Initiate a Phone Call	48
Select a Phone Number	49
Make a Phone Call	49
Enhanced Private Conversation Calls (ASTRO 25 Trunking Only)	51
Quick Access (One-Touch)	51
Answer a Private Call	52
Initiate a Private Call	53
Select an ID Number	53
Make a Private Call	54
Call Alert Paging (ASTRO 25 Trunking Only)	55
Quick Access (One-Touch)	55
Answer a Call Alert Page	56
Initiate a Call Alert Page	56
Select an ID Number	56
Send a Call Alert Page	57
Conventional Talkgroup Calls (Conventional Operation Only)	58
Select a Talkgroup	58
Status Calls (ASTRO 25 Trunking Only)	60
Send a Status Call	60
Repeater or Direct Operation	62
Smart PTT (Conventional Only)	64
Special Radio Features	65
Secure Operations	65
Select Secure Transmissions	65
Select Clear Transmissions	65

Contents

PTT ID66
 Receive66
 Transmit66
View Your Radio's ID Number67
Dynamic Regrouping (ASTRO 25 Trunking Only)68
 Reprogram Request68
 Select Enable / Disable70
Trunking System Controls71
 Failsoft71
 Out-of-Range71
 Site Lock72
 Site Trunking73
 Site View and Change74
Time and Date75

Helpful Tips 79

Radio Care79
 Things to Avoid79
 Cleaning80
 Handling80
Service81
Battery82
 Battery Life82
 Charging the Battery82
 Battery Recycling and Disposal83
Antenna85
 Radio Operating Frequencies85

Accessories..... 87

Antennas87
Batteries87
Carry Accessories88
 Belt Clips88
 Belt Loops88
 Carry Cases88
Chargers88
 Enhanced and Multi-Unit Line Cords89
Headset / Surveillance Accessories89
 Earpieces89
 Headset Accessories89

Ear Microphones (Require Radio Interface Module)	90
Radio Interface Modules for Ear Microphones	90
Remote Speaker and Public Safety Microphones	90
Vehicular Adapters	90
Accessories	90
Allied Models	91
Glossary	93
Commercial Warranty	97
Index	103

Notes

User Safety, Training, and General Information

READ THIS IMPORTANT INFORMATION ON SAFE AND EFFICIENT OPERATION BEFORE USING YOUR MOTOROLA HANDHELD PORTABLE TWO-WAY RADIO

The information provided in this document supersedes the general safety information contained in user guides published prior to June 2001. For information regarding radio use in a hazardous atmosphere please refer to the Factory Mutual (FM) Approval Manual Supplement or Instruction Card, which is included with radio models that offer this capability.

Compliance with RF Energy Exposure Standards

Your Motorola two-way radio is designed and tested to comply with a number of national and international standards and guidelines (listed below) regarding human exposure to radio frequency electromagnetic energy. This radio complies with the IEEE (FCC) and ICNIRP exposure limits for occupational/controlled RF exposure environment at duty cycles of up to 50% talk-50% listen and should be used for occupational use only. In terms of measuring RF energy for compliance with the FCC exposure guidelines, your radio radiates measurable RF energy only while it is transmitting (during talking), not when it is receiving (listening) or in standby mode. Note that the approved, supplied batteries for this radio are rated for a 5-5-90 duty cycle (5% talk-5% listen - 90% standby), even though this radio complies with the FCC occupational exposure limits at duty cycles of up to 50% talk.

Your Motorola two-way radio complies with the following RF energy exposure standards and guidelines:

- United States Federal Communications Commission, Code of Federal Regulations; 47CFR part 2 sub-part J
- American National Standards Institute (ANSI) / Institute of Electrical and Electronic Engineers (IEEE) C95. 1-1992

- Institute of Electrical and Electronic Engineers (IEEE) C95.1-1999 Edition
- International Commission on Non-Ionizing Radiation Protection (ICNIRP) 1998
- Ministry of Health (Canada) Safety Code 6. Limits of Human Exposure to Radiofrequency Electromagnetic Fields in the Frequency Range from 3 kHz to 300 GHz, 1999
- Australian Communications Authority Radiocommunications (Electromagnetic Radiation - Human Exposure) Standard 1999 (applicable to wireless phones only)
- ANATEL, Brasil Regulatory Authority, Resolution 256 (April 11, 2001) "additional requirements for SMR, cellular and PCS product certification."

Operational Instructions and Training Guidelines



To ensure optimal performance and compliance with the occupational/controlled environment RF energy exposure limits in the above standards and guidelines, users should transmit no more than 50% of the time and always adhere to the following procedures:

Transmit and Receive

- **To transmit (talk), push the Push-To-Talk (PTT) button; to receive, release the PTT button.**

Hand-held radio operation

- **Hold the radio in a vertical position with the microphone one to two inches (2.5 to 5 cm) away from the lips.**

Body-worn operation

- **Always place the radio in a Motorola approved clip, holder, holster, case, or body harness for this product.** Use of non-Motorola-approved accessories may exceed FCC RF exposure guidelines.
- If you do not use a Motorola approved body-worn accessory and are not using the radio in the intended use position in front

of the face, then ensure the antenna and the radio are kept 2.5 cm (one inch) from the body when transmitting.

Antennas & Batteries

- **Use only Motorola approved supplied antenna or Motorola approved replacement antenna.** Unauthorized antennas, modifications, or attachments could damage the radio and may violate FCC regulations.
- **Use only Motorola approved, supplied batteries or Motorola approved replacement batteries.** Use of non-Motorola-approved antennas or batteries may exceed FCC RF exposure guidelines.

Approved Accessories

- For a list of Motorola approved accessories see the appendix of this user manual or visit the following website which lists approved accessories:

<http://www.motorola.com/cgiss/portables/xts5000.shtml>

Electromagnetic Interference/Compatibility

Note: Nearly every electronic device is susceptible to electromagnetic interference (EMI) if inadequately shielded, designed, or otherwise configured for electromagnetic compatibility.

Facilities

To avoid electromagnetic interference and/or compatibility conflicts, turn off your radio in any facility where posted notices instruct you to do so. Hospitals or health care facilities may be using equipment that is sensitive to external RF energy.

Aircraft

When instructed to do so, turn off your radio when on board an aircraft. Any use of a radio must be in accordance with applicable regulations per airline crew instructions.

Medical Devices

Pacemakers

The Advanced Medical Technology Association (AdvaMed) recommends that a minimum separation of 6 inches (15 centimeters) be maintained between a handheld wireless radio and a pacemaker. These recommendations are consistent with those of the U.S. Food and Drug Administration.

Persons with pacemakers should:

- ALWAYS keep the radio more than 6 inches (15 centimeters) from their pacemaker when the radio is turned ON.
- not carry the radio in the breast pocket.
- use the ear opposite the pacemaker to minimize the potential for interference.
- turn the radio OFF immediately if you have any reason to suspect that interference is taking place.

Hearing Aids

Some digital wireless radios may interfere with some hearing aids. In the event of such interference, you may want to consult your hearing aid manufacturer to discuss alternatives.

Other Medical Devices

If you use any other personal medical device, consult the manufacturer of your device to determine if it is adequately shielded from RF energy. Your physician may be able to assist you in obtaining this information.

Driver Safety

Check the laws and regulations on the use of radios in the area where you drive. Always obey them.

When using your radio while driving, please:

- Give full attention to driving and to the road.
- Use hands-free operation, if available.
- Pull off the road and park before making or answering a call if driving conditions so require.

Operational Warnings



For Vehicles With an Air Bag

Do not place a portable radio in the area over an air bag or in the air bag deployment area. Air bags inflate with great force. If a portable radio is placed in the air bag deployment area and the air bag inflates, the radio may be propelled with great force and cause serious injury to occupants of the vehicle.

Potentially Explosive Atmospheres

Turn off your radio prior to entering any area with a potentially explosive atmosphere, unless it is a radio type especially qualified for use in such areas as “Intrinsically Safe” (for example, Factory Mutual, CSA, UL, or CENELEC). Do not remove, install, or charge batteries in such areas. Sparks in a potentially explosive atmosphere can cause an explosion or fire resulting in bodily injury or even death.

Note: The areas with potentially explosive atmospheres referred to above include fueling areas such as below decks on boats, fuel or chemical transfer or storage facilities, areas where the air contains chemicals or particles, such as grain, dust or metal powders, and any other area where you would normally be advised to turn off your vehicle engine. Areas with potentially explosive atmospheres are often but not always posted.

Blasting Caps and Blasting Areas

To avoid possible interference with blasting operations, turn off your radio when you are near electrical blasting caps, in a blasting area, or in areas posted: “Turn off two-way radio.” Obey all signs and instructions.

Operational Cautions



Caution

Antennas

Do not use any portable radio that has a damaged antenna. If a damaged antenna comes into contact with your skin, a minor burn can result.

Batteries

All batteries can cause property damage and/or bodily injury such as burns if a conductive material such as jewelry, keys, or beaded chains touches exposed terminals. The conductive material may complete an electrical circuit (short circuit) and become quite hot. Exercise care in handling any charged battery, particularly when placing it inside a pocket, purse, or other container with metal objects.

Intrinsically Safe Radio Information

FMRC Approved Equipment

Anyone intending to use a radio in a location where hazardous concentrations of flammable materials exist (hazardous atmosphere) is advised to become familiar with the subject of intrinsic safety and with the National Electric Code NFPA 70 (National Fire Protection Association) Article 500 (hazardous [classified] locations).

An Approval Guide, issued by Factory Mutual Research Corporation (FMRC), lists manufacturers and the products approved by FMRC for use in such locations. FMRC has also issued a voluntary approval standard for repair service (“Class Number 3605”).



FMRC Approval labels are attached to the radio to identify the unit as being FM Approved for specified hazardous atmospheres. This label specifies the hazardous Class/Division/Group along with the part number of the battery that must be used. Depending on the design of the portable unit, this FM label can be found on the back or the bottom of the radio housing. The FM Approval mark is shown here.



WARNING

- **Do not operate radio communications equipment in a hazardous atmosphere unless it is a type especially qualified (for example, FMRC Approved) for such use. An explosion or fire may result.**
- **Do not operate an FMRC Approved Product in a hazardous atmosphere if it has been physically damaged (for example, cracked housing). An explosion or fire may result.**
- **Do not replace or charge batteries in a hazardous atmosphere. Contact sparking may occur while installing or removing batteries and cause an explosion or fire.**
- **Do not replace or change accessories in a hazardous atmosphere. Contact sparking may occur while installing or removing accessories and cause an explosion or fire.**
- **Do not operate an FMRC Approved Product unit in a hazardous location with the accessory contacts exposed. Keep the connector cover in place when accessories are not used.**
- **Turn a radio off before removing or installing a battery or accessory.**
- **Do not disassemble an FMRC Approved Product unit in any way that exposes the internal electrical circuits of the unit.**

Radios must ship from the Motorola manufacturing facility with the hazardous atmosphere capability and FM Approval labeling. Radios will not be “upgraded” to this capability and labeled in the field.

A modification changes the unit’s hardware from its original design configuration. Modifications can only be made by the original product manufacturer at one of its FMRC-audited manufacturing facilities.



- **Failure to use an FMRC Approved Product unit with an FMRC Approved battery or FMRC Approved accessories specifically approved for that product may result in the dangerously unsafe condition of an unapproved radio combination being used in a hazardous location.**
- **Unauthorized or incorrect modification of an FMRC Approved Product unit will negate the Approval rating of the product.**

Repair of FMRC Approved Products

REPAIRS FOR MOTOROLA PRODUCTS WITH FMRC APPROVAL ARE THE RESPONSIBILITY OF THE USER.

You should not repair or relabel any Motorola-manufactured communication equipment bearing the FMRC Approval label (“FMRC Approved Product”) unless you are familiar with the current FMRC Approval standard for repairs and service (“Class Number 3605”).

You may want to consider using a repair facility that operates under 3605 repair service approval.



- **Incorrect repair or relabeling of any FMRC Approved Product unit could adversely affect the Approval rating of the unit.**
- **Use of a radio that is not intrinsically safe in a hazardous atmosphere could result in serious injury or death.**

FMRC’s Approval Standard Class Number 3605 is subject to change at any time without notice to you, so you may want to obtain a current copy of 3605 from FMRC. Per the December 1994 publication of 3605, some key definitions and service requirements are as follows:

Repair

A repair constitutes something done internally to the unit that would bring it back to its original condition—Approved by FMRC. A repair should be done in an FMRC Approved facility.

Items not considered as repairs are those in which an action is performed on a unit which does not require the outer casing of the unit to be opened in a manner which exposes the internal electrical circuits of the unit. You do not have to be an FMRC Approved Repair Facility to perform these actions.

Relabeling

The repair facility shall have a method by which the replacement of FMRC Approval labels are controlled to ensure that any relabeling is limited to units that were originally shipped from the Manufacturer with an FM Approval label in place. FMRC Approval labels shall not be stocked by the repair facility. An FMRC Approval label shall be ordered from the original manufacturer, as needed, to repair a specific unit. Replacement labels may be obtained and applied by the repair facility, provided there is satisfactory evidence that the unit being relabeled was originally an FMRC Approved unit. Verification may include, but is not limited to: a unit with a damaged Approval label, a unit with a defective housing displaying an Approval label, or a customer invoice indicating the serial number of the unit and purchase of an FMRC Approved model.

Do Not Substitute Options or Accessories

The Motorola communications equipment certified by Factory Mutual is tested as a system and consists of the FM Approved portable, FM Approved battery, and FM Approved accessories or options, or both. This FM Approved portable and battery combination must be strictly observed. There must be no substitution of items, even if the substitute has been previously Approved with a different Motorola communications equipment unit. Approved configurations are listed in the FM Approval Guide published by FMRC, or in the product FM Supplement. This FM Supplement is shipped from the manufacturer with the FM Approved radio and battery combination. The Approval

Guide, or the Approval Standard Class Number 3605 document for repairs and service, can be ordered directly from Factory Mutual Research Corporation located in Norwood, Massachusetts.

Notes

General Radio Operation

Notations Used in This Manual

Throughout the text in this publication, you will notice the use of **WARNINGS**, **Cautions**, and **Notes**. These notations are used to emphasize that safety hazards exist, and the care that must be taken or observed.



An operational procedure, practice, or condition, etc., which may result in injury or death if not carefully observed.





Caution

An operational procedure, practice, or condition, etc., which may result in damage to the equipment if not carefully observed.

Note: An operational procedure, practice, or condition, etc., which is essential to emphasize.

The following special notations identify certain items:

<i>Example</i>	<i>Description</i>
Light button or 	Buttons and keys are shown in bold print or as a key symbol.
	Information appearing on the radio's display is shown using the special display font.
PHONE	Menu entries are shown similar to the way they appear on the radio's display.
Press 	This means "Press the right side of the 4-way Navigation button."

Your XTS 5000 Model II Radio

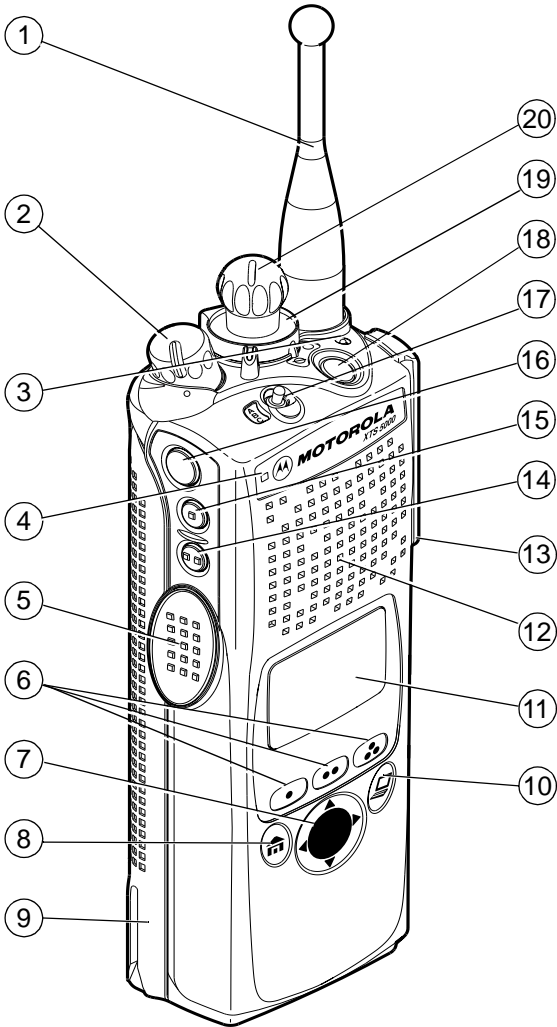

Physical Features of the XTS 5000 Model II Radio

Table 1: Physical Features

<i>No.</i>	<i>Feature</i>	<i>Page</i>	<i>No.</i>	<i>Feature</i>	<i>Page</i>
1	Antenna	16	8	Home Button	8
2	On/Off/Volume Control Knob	19	9	Battery	13
3	LED	9	10	Alpha Button	8
4	Microphone		11	Display	4
5	PTT (Push-to-Talk) Button		12	Speaker	
6	Menu Select Buttons	7	13	Universal Connector	18
7	4-Way Navigation Button	8			

Programmable Controls

The following radio controls can be programmed to operate certain software-activated features.

<i>No.</i>	<i>Feature</i>	<i>No.</i>	<i>Feature</i>
14	Side Button 2	18	Top Button
15	Side Button 1	19	2-Position Concentric Switch
16	Top Side (Select) Button	20	16-Position Select Knob
17	3-Position A/B/C Switch		

The features that can be assigned to these controls by a qualified radio technician, and the pages where these features can be found are listed in Table 2 on page 4.

Any references in this manual to controls that are “preprogrammed” mean that a qualified radio technician must use the radio’s programming software to assign a feature to a control.

Table 2: Programmable Features

<i>Feature</i>	<i>Page</i>	<i>Feature</i>	<i>Page</i>	<i>Feature</i>	<i>Page</i>
Call Alert	55	Phone	49	Site Lock/Unlock	72
Call Response	52	PL Defeat	31	Site Search	74
Channel	21	Private Call	51	Smart Battery	15
Dynamic Priority	46	Repeater/Direct	63	Status	61
Emergency	33	Reprogram Request	69	TX Power Level	28
Keypad Mute	29	Scan List Programming	40	Volume Set	23
Light	5	Scan On/Off	44	Zone	20
Monitor	24	Secure/Clear	65		
Nuisance Delete	45	Select	42		

Display

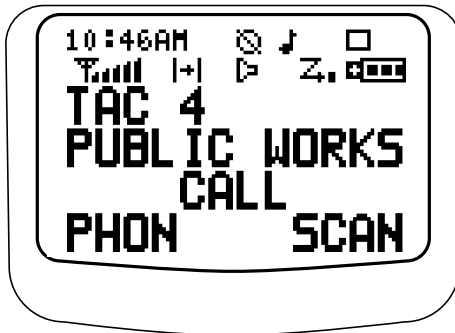

The above screen is typical of what you will see on your radio. The 64 x 96 pixel liquid crystal display (LCD) shows radio status, text, and menu entries.

Backlight

If poor light conditions make the display, keypad, or channel numbers (around the **16-Position Select** knob) difficult to read, turn on the radio's backlights by pressing the preprogrammed **Light** button.

These lights will remain on for a preprogrammed time before they turn off automatically, or you can turn them off immediately by pressing the **Light** button again.

Status Symbols

The top two display rows contain symbols that indicate radio operating conditions.

Table 3: Status Symbols







Symbol	Indication	Page No.
	Call Received Flashes when an Individual Call is received.	48, 52, 56
	View/Program Mode The radio is in the view or program mode. <ul style="list-style-type: none"> • On steady = view mode • Flashing = program mode 	37,38,39, 40,42
	Received Signal Strength Indication (RSSI) The received signal strength for the current site, for trunking only. The more stripes in the symbol, the stronger the signal.	74
	Battery <ul style="list-style-type: none"> • Conventional = flashes when battery is low • Smart = The number of bars (0-3) shown indicates the charge remaining in your battery; flashes when battery is low 	83

Table 3: Status Symbols (Continued)

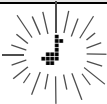
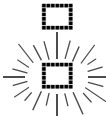
Symbol	Indication	Page No.
	<p>Talkaround</p> <ul style="list-style-type: none"> • On = you are talking directly to another radio, not through a repeater, during conventional operation only • Off = you are talking through a repeater 	62-63
	<p>Monitor (Carrier Squelch)</p> <p>The selected channel is being monitored during conventional operation only.</p>	25, 30, 31
	<p>Secure Operation</p> <ul style="list-style-type: none"> • On = secure operation • Off = clear operation • Flashing = receiving an encrypted voice call 	65
	<p>Scan</p> <p>The radio is scanning a scan list.</p>	38 thru 44
 (Dot Flashing)	<p>Priority-One Channel Scan</p> <p>One channel is assigned as the priority channel during scan operation.</p>	38 thru 43
 (Dot Steady)	<p>Priority-Two Channel Scan</p> <p>Two channels are assigned as the priority channels during scan operation.</p>	38 thru 43

Text

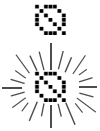
Depending on the information being shown, the display can have several rows of text.

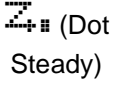
Menu Entry (Softkey)

The bottom row of the display contains one to three menu entries (also known as softkeys). The menu entries allow you to select one of several menus to access the radio's features. The menu entries are accessed through the **Menu Select** buttons.

Menu Select Buttons

The **Menu Select** buttons access the menu entries of features that have been activated by a qualified radio technician. Your radio may be programmed differently from the following example, but the display for turning Scan on or off might look like the example below. For instance, to turn Scan on, press  directly below ON.

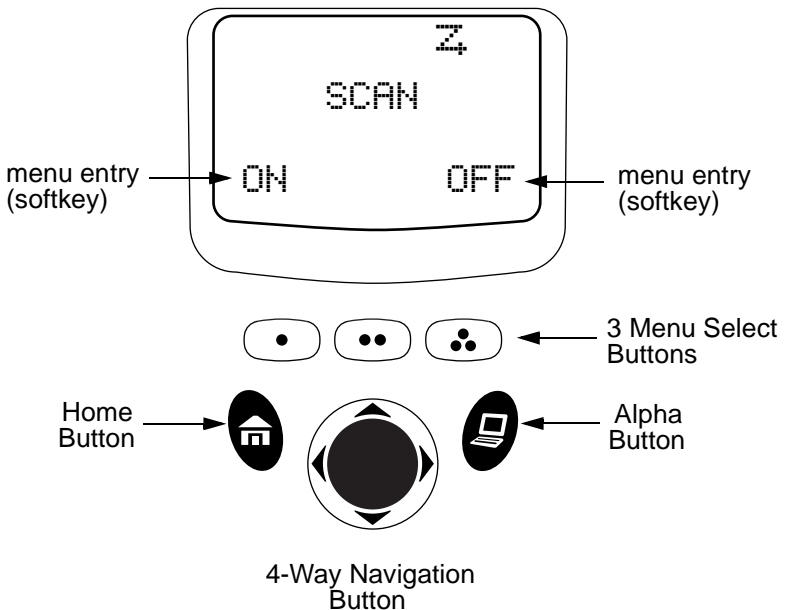

Menu Entry Features

Table 4: Menu Entries

<i>Feature</i>	<i>Menu Selection</i>	<i>Page</i>	<i>Feature</i>	<i>Menu Selection</i>	<i>Page</i>
Smart Battery	BATT	15	TX Power Level	PWR	27
Private Call	CALL	53	Reprogram Request	RPGM	68
Channel Selection	CHAN	21	Scan On/Off	SCAN	44
Time and Date	CLCK	75	Site Lock/Unlock	SITE	72
Repeater/Direct	DIR	62	Status Call	STS	60
Keypad Mute	MUTE	29	Talkgroup Call	TGRP	58
Call Alert Page	PAGE	56	View a List	VIEW	37
Phone	PHON	48	Zone	ZONE	20
Editing	PROG	38			

Home Button

The **Home** button always returns you to the home (default) display. In most cases, this is the current mode.

Some radio features that you can edit require saving information in memory. Pressing the **Home** button after editing those features causes information to be saved before going to the home display.

Some features do not require you to press the **Home** button to go to the home display. This reduces the required number of key presses.

Alpha Button

Reserved for future use.

4-Way Navigation Button

This button is used to scroll through the radio's lists or items in the display, or both.

LED Indicators

The LED on top of the radio indicates the radio's operating status:

Table 5: LED Indicators

<i>LED Indicator</i>	<i>What it Means</i>
Red	Radio transmitting
Flashing red	<ul style="list-style-type: none">• Channel busy, or• Low battery (while transmitting)
Double flashing red	Receiving encrypted audio
Flashing green	Receiving an individual call

Alert Tones

An alert tone is a sound or group of sounds. Your radio uses alert tones to inform you of your radio's conditions. The following table lists these tones and when they occur.

Table 6: Alert Tones

<i>You Hear</i>	<i>Tone Name</i>	<i>Heard</i>
Short, Low-Pitched Tone	Invalid Key-Press	when wrong key is pressed
	Radio Self-Test Fail	when radio fails its power-up self test
	Reject	when unauthorized request is made
	Time-Out Timer Warning	four seconds before time out
Long, Low-Pitched Tone	No ACK Received	when radio fails to receive an acknowledgment from the dispatcher
	Time-Out Timer Timed Out	after time out
	Talk Prohibit/ PTT Inhibit	(when PTT button is pressed) transmissions are not allowed
	Out-of-Range	(when PTT button is pressed) the radio is out of range of the system
	Invalid Mode	when radio is on an unprogrammed channel
	Individual Call Warning Tone	when radio is in an individual call for greater than 6 seconds without any activity
A Group of Low-Pitched Tones	Busy	when system is busy

Table 6: Alert Tones (Continued)

<i>You Hear</i>	<i>Tone Name</i>	<i>Heard</i>
Short, Medium- Pitched Tone	Valid Key-Press	when correct key is pressed
	Radio Self-Test Pass	when radio passes its power-up self test
	Clear Voice	at beginning of a non-coded communication
	Priority Channel Received	when activity on a priority channel is received
	Emergency Alarm Entry	when entering the emergency state
	Central Echo	when central controller has received a request from a radio
Long, Medium- Pitched Tone	Volume Set	when volume is changed on a quiet channel
	Emergency Exit	when exiting the emergency state
A Group of Medium- Pitched Tones	Failsoft	when the trunking system fails
	Automatic Call Back	when voice channel is available from previous request
	Talk Permit	(when PTT button is pressed) verifying system accepting transmissions
	Keyfail	when encryption key has been lost
	Console Acknowledge	when status, emergency alarm, or reprogram request ACK is received
	Received Individual Call	when Call Alert or Private Conversation call is received
	Call Alert Sent	when Call Alert is received by the target radio
Short, High-Pitched Tone (Chirp)	Low-Battery Chirp	when battery is below preset threshold value

Table 6: Alert Tones (Continued)

<i>You Hear</i>	<i>Tone Name</i>	<i>Heard</i>
Ringing	Fast Ringing	when system is searching for target of Private Conversation call
	Enhanced Call Sent	when waiting for target of Private Conversation call to answer the call
	Phone Call Received	when a land-to-mobile phone call is received
Gurgle	Dynamic Regrouping	(when the PTT button is pressed) a dynamic ID has been received

Standard Accessories

Battery



To avoid a possible explosion:

- **DO NOT** replace the battery in any area labeled “hazardous atmosphere”.
- **DO NOT** discard batteries in a fire.

Charging the Battery

The Motorola-approved battery shipped with your radio is uncharged. Prior to using a new battery, charge it for a minimum of 16 hours to ensure optimum capacity and performance.

For a list of Motorola-authorized batteries available for use with your XTS 5000 radio, see “Batteries” on page 87.

Note: When charging a battery attached to a radio, turn the radio off to ensure a full charge.

Battery Charger

To charge the battery, place the battery, with or without the radio, in a Motorola-approved charger. The charger’s LED indicates the charging progress; see your charger’s user guide. For a list of chargers, see “Chargers” on page 88.

Battery Charge Status

If programmed by a qualified radio technician, you can check your battery’s charge status by holding down the pre-programmed **Battery Gauge** button on the radio. Charge status is shown by the color of the radio’s LED.

<i>Battery Level</i>	<i>LED Indicator</i>
High	Green
Sufficient	Yellow
Low	Flashing Red
Very low	None

Attach the Battery

- 1 With the radio turned off, insert the top edge of the battery into the radio's frame as shown.

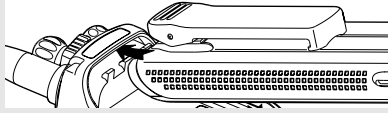

- 2 Rotate the battery toward the radio and press down until the battery clicks into place.

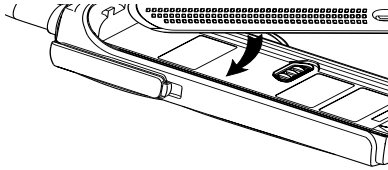

Remove the Battery

- 1 With the radio turned off, press the release button on the bottom of the battery until the battery releases from the radio.

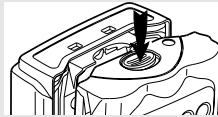

- 2 Remove the battery from the radio.

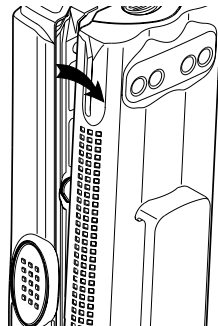

Note: If your radio is programmed with volatile-key retention, encryption keys will be retained for approximately 30 seconds after battery removal. Consult a qualified radio technician for details.



Smart Battery Condition

This feature lets you view the condition of your Smart Battery.

Use the Menu

- 1 Press  to find BATT.

BATT

- 2 Press , , or  directly below BATT.

```
CAPACITY      70%
INIT          10/01
EST CHGS      11
```

Note: If a Smart Battery is not powering your radio.

```
SMART BATT
DATA NOT
AVAILABLE.
```

- 3 Press  to exit.

Use the Preprogrammed Smart Battery Button

- 1 Press the **Smart Battery** button.

```
CAPACITY      70%
INIT          10/01
EST CHGS      11
```

Note: If a Smart Battery is not powering your radio.

```
SMART BATT
DATA NOT
AVAILABLE.
```

- 2 Press  to exit.

Antenna

For information regarding available antennas, see page 85.

Attach the Antenna

With the radio turned off, turn the antenna clockwise to attach it to the radio.



Remove the Antenna

With the radio turned off, turn the antenna counter-clockwise to remove it from the radio.

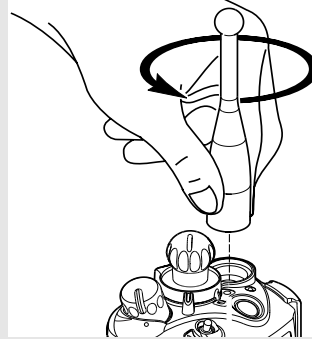

Belt Clip

Attach the Belt Clip

- 1 Align the grooves of the belt clip with those of the battery.

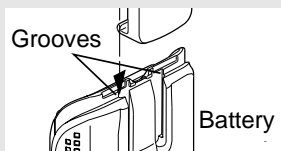

- 2 Press the belt clip downward until you clear a click.

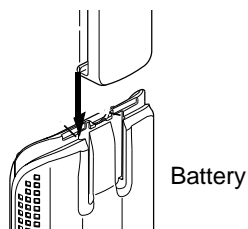

Remove the Belt Clip

- 1 Use a flat-bladed object to press the belt clip tab away from the battery.

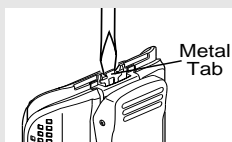

- 2 Slide the belt clip upward to remove it.

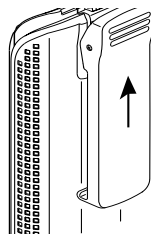

Universal Connector Cover

The universal connector is located on the antenna side of the radio. It is used to connect accessories to the radio.

Note: To prevent damage to the connector, shield it with the connector cover when not in use.

Remove the Connector Cover

- 1 Insert a flat-bladed screwdriver into the area between the bottom of the cover and the slot below the connector.
- 2 Hold the top of the cover with your thumb while you pry the bottom of the cover away from the radio with the screwdriver.

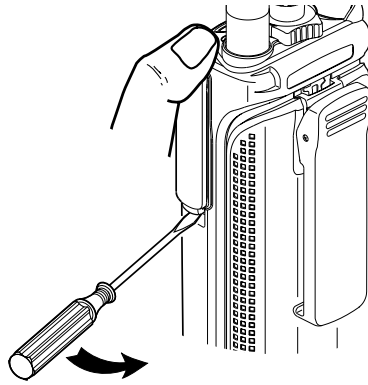

Attach the Connector Cover

- 1 Insert the hooked end of the cover into the slot above the connector. Press downward on the cover's top to seat it in the slot.
- 2 Rub the ball of your thumb from the top to the bottom of the cover while applying pressure towards the radio. This should flex the cover and snap it into place.

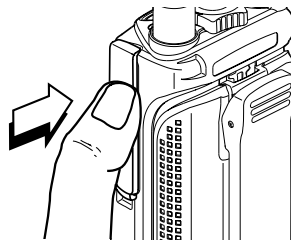
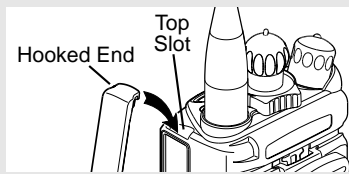

Radio On and Off

Turn the Radio On

Turn the **On/Off/Volume Control** knob clockwise.

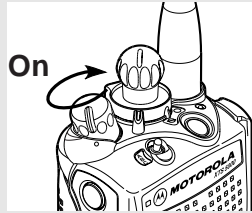

Note: If the power-up test is successful, you briefly see **SELF TEST**, then the home display.

SELF TEST

Note: If the power-up test is unsuccessful, you see **ERROR XX/YY**. (XX/YY is an alphanumeric code.)

ERROR XX/YY

Turn off the radio, check the battery, and turn the radio on. If the radio fails the power-up test again, record the **ERROR XX/YY** code and contact a qualified radio technician.

Turn the Radio Off

Turn the **On/Off/Volume Control** knob counterclockwise until it clicks.

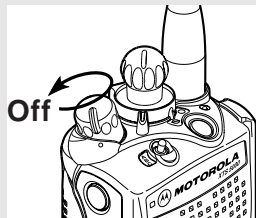

Zones and Channels

A zone is a grouping of channels. A channel is a group of radio characteristics, such as transmit/receive frequency pairs.



Before you use your radio to receive or send messages, you should select the zone and channel.

Select a Zone

Use the Menu

- 1 Press  to find ZONE.



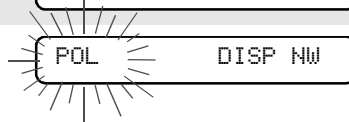

- 2 Press , , or  directly below ZONE.

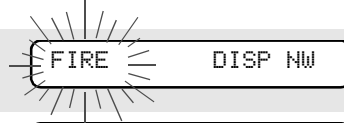

The current zone (in this case, POL) flashes and the channel name (DISP NW), does not flash.

- 3 Press  to find the zone you want. For example, FIRE.



- 4 Press  to confirm the displayed zone and channel.



OR

Press the **PTT** button to transmit on the displayed zone/channel.

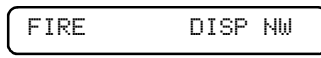

Use the Preprogrammed Zone Switch

- 1 If a control on your radio has been preprogrammed as the **Zone** switch, move the **Zone** switch to the position for the zone you want.



Note: If the zone you selected is unprogrammed, repeat step 1.

UNPROGRAMMED

2 Press  to confirm the displayed zone and channel.

FIRE DISP NW

Select a Channel

Consult a qualified radio technician for the right choice between the following methods:

Method 1: Use the Preprogrammed 16-Position Select Knob

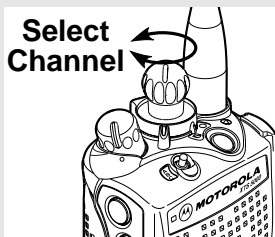

After the zone you want is displayed, turn the **16-Position Select** knob to the desired channel.



Method 2: Use the Menu

1 Press  to find CHAN.

CHAN

2 Press , , or  directly below CHAN.

POL DISP NW

The display shows the current channel name (in this case, DISP NW) flashing and the zone (POL), not flashing.

3 Press  to find the channel name you want.

POL DISP SE

4 If the channel you selected is unprogrammed, repeat step 3.

UNPROGRAMMED

- 5** Press  to confirm the displayed zone and channel.



OR

Press the **PTT** button to transmit on the displayed zone/channel.

Receive / Transmit

Radio users who switch from analog to digital radios often assume that the lack of static on a digital channel is an indication that the radio is not working properly. This is not the case. Digital technology quiets the transmission by removing the “noise” from the signal and allowing only the clear voice or data information to be heard.

This section emphasizes the importance of knowing how to monitor a channel for traffic before keying up to send a transmission.

Without Using the Volume Set and Monitor Buttons

1 Turn the radio on and select the desired zone and channel.

2 Listen for a transmission.

3 Adjust the **Volume Control** knob if necessary.

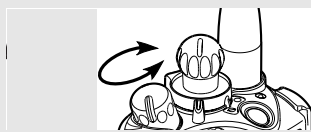

4 Press and hold the **PTT** button to transmit. The LED lights RED while transmitting.

5 Release the **PTT** button to receive (listen).

Use the Preprogrammed Volume Set Button

1 Turn the radio on and select the desired zone and channel.

2 Press and hold the **Volume Set** button to hear the volume set tone.

- 3 Adjust the **Volume Control** knob if necessary.

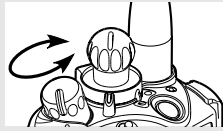

- 4 Release the **Volume Set** button.

- 5 Press and hold the **PTT** button to transmit. The LED lights RED while transmitting.

- 6 Release the **PTT** button to receive (listen).
-

Use the Preprogrammed Monitor Button

- 1 Turn the radio on and select the desired zone and channel.

- 2 Press the **Monitor** button and listen for activity. (See the following **Conventional Mode Operation**.)

- 3 Adjust the **Volume Control** knob if necessary.

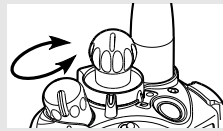

- 4 Press and hold the **PTT** button to transmit. The LED lights RED while transmitting.

- 5 Release the **PTT** button to receive (listen).
-

Conventional Mode Operation

Your radio may be programmed to receive Private-Line® (PL) calls:

- 1** Momentarily press the **Monitor** button to listen for activity. The Carrier Squelch indicator is displayed.



- 2** Press and hold the **Monitor** button to set continuous monitor operation. (The duration of the button press is programmable.)

- 3** Press the **Monitor** button again, or the **PTT** button, to return to the original squelch setting.

Note: If you try to transmit on a receive-only channel, you will hear an invalid tone until you release the **PTT** button.

Notes

Common Radio Features

Selectable Power Level

This feature lets you select the power level at which your radio will transmit. The radio will always turn on to the default setting. This feature must be preprogrammed by a qualified radio technician.



- Select **LOW** for a shorter transmitting distance and to conserve power.
- Select **HIGH** for a longer transmitting distance.

Use the Menu

1 Press  to find **PWR**.



PWR

2 Press , , or  directly below **PWR**. The display shows the current power level, along with **LOW** and **HIGH**.

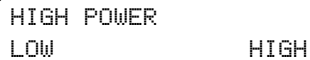

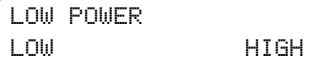

HIGH POWER
LOW HIGH

OR



LOW POWER
LOW HIGH

3 Press , , or  directly below the desired power level (**LOW** or **HIGH**).

- The new transmit power level is saved.
- The radio returns to the home display.

Note: To exit without changing the setting, press  or the **PTT** button.

Use the Preprogrammed Transmit Power Level Switch

- 1** Move the **TX Power Level** switch to the **Low Power** position. The power level is set to Low.
 - 2** Move the **TX Power Level** switch to the **High Power** position. The power level is set to High.
-

Mute or Unmute Keypad Tones



You can turn the keypad tones on or off.

Use the Menu

- 1 Press  to find MUTE.



MUTE

- 2 Press , , or  directly below MUTE. The current state is shown.

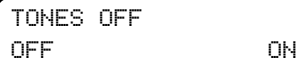



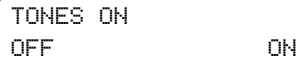

TONES OFF
OFF ON

OR



TONES ON
OFF ON

- 3 Press , , or  directly below OFF or ON.

Note: Press  or the **PTT** button to exit without changing the setting.

Use the Preprogrammed Keypad Mute Button

Press the **Keypad Mute** button to turn the tones off or on.

Conventional Squelch Operation

Analog Options

Tone Private Line (PL), Digital Private-Line (DPL), and carrier squelch can be available (preprogrammed) per channel.

<i>When in</i>	<i>This condition occurs</i>
Carrier squelch (T ²)	You hear all traffic on a channel.
PL, or DPL	The radio responds only to your messages.

Digital Options

One or more of the following options may be programmed in your radio. Consult your service technician for more information.

<i>This option</i>	<i>Will allow you to hear</i>
Digital Carrier-Operated Squelch (COS)	Any digital traffic.
Normal Squelch	Any digital traffic having the correct network access code.
Selective Switch	Any digital traffic having the correct network access code and correct talkgroup.

PL Defeat

With this feature, you can override any coded squelch (DPL or PL) that might be preprogrammed to a channel.

Place the preprogrammed **PL Defeat** switch in the **PL Defeat** position. You can now hear any activity on the channel. The radio is muted if no activity is present.

When this feature is active, the Carrier Squelch status indicator (🔇) will be displayed.



Time-out Timer

The time-out timer turns off your radio's transmitter. The timer is set for 60 seconds at shipment, but it can be programmed from 0 to 7.75 minutes (465 seconds) by a qualified radio technician.

- | | | |
|----------|---|---|
| 1 | Hold down the PTT button longer than the programmed time. You will hear a short, low-pitched warning tone, the transmission will cut-off, and the LED will go out until you release the PTT . | <ul style="list-style-type: none">• Short warning tone• Transmission is cut-off• LED goes out |
| 2 | Release the PTT button. | <ul style="list-style-type: none">• LED re-lights• Timer resets |
| 3 | Press the PTT to re-transmit. The time-out timer restarts. | <ul style="list-style-type: none">• Timer restarts• LED is red |

Emergency

If the top (orange) button is programmed to send an emergency signal, then this signal overrides any other communication over the selected channel.

Your radio can be programmed for the following:

- Emergency Alarm
- Emergency Call
- Emergency Alarm with Emergency Call
- Silent Emergency Alarm

Consult a qualified radio technician for emergency programming of your radio.

Send an Emergency Alarm

An emergency alarm sends a data transmission to the dispatcher, which identifies the radio sending the emergency.

- 1 With your radio turned on, press the **Emergency** button. The current zone/channel is displayed alternately with **EMERGENCY**, the red LED lights, and a short, medium-pitched tone sounds.



EMERGENCY

- Red LED
- Short tone

If the selected channel does not support emergency, the display shows **NO EMERGENCY**. Select a channel that does show **EMERGENCY**.



NO EMERGENCY

Note: To exit emergency at any time, press and hold the **Emergency** button for about a second.

- 2 When you receive the dispatcher's acknowledgment, you see `ACK RECEIVED`, four tones sound, the alarm ends, and the radio exits the emergency mode.

`ACK RECEIVED`

- Four tones
- Alarm ends
- Radio exits emergency

If no acknowledgement is received, you see `NO ACKNOWLEDG`, the alarm ends, and the radio exits the emergency mode.

`NO ACKNOWLEDG`

- Alarm ends
- Radio exits emergency

Note: For Emergency Alarm with Emergency Call: The radio enters the Emergency Call state either after it receives the dispatcher's acknowledgment, or if you press the **PTT** button while in Emergency Alarm. Go to step 2 of "Send an Emergency Call", below.

Send an Emergency Call

This type of dispatch gives your radio priority access to channels

The radio operates in the normal dispatch manner while in Emergency Call, except, if enabled, it will return to one of the following:

- Tactical/Non-Revert — You talk on the channel you selected before you entered the emergency state.
- Non-Tactical/Revert — You talk on a preprogrammed emergency channel. The emergency alarm is sent on this same channel.

- 1 With your radio turned on, press the **Emergency** button. The current zone/channel is displayed alternately with `EMERGENCY`, and a short, medium-pitched tone sounds.

`EMERGENCY`

- Short tone

Note: To exit emergency at any time, press and hold the **Emergency** button.

- 2 Press and hold the **PTT** button and announce your emergency into the microphone.
- 3 Release the **PTT** button to end the transmission and wait for a response from the dispatcher.
- 4 Press and hold the **Emergency** button for about a second to exit emergency.

Send a Silent Emergency Alarm

- 1 With your radio turned on, press the **Emergency** button. The display does not change, the LED does not light, and you hear no tones.
 - Display does not change
 - LED does not light
 - No tones

Note: To exit emergency at any time, press and hold the **Emergency** button for about a second.

- 2 The silent emergency state continues until you:
 - Press and hold **Emergency** button

OR

 - Press and release the **PTT** button

OR

Press and release the **PTT** button to exit silent emergency and enter regular dispatch or emergency call.

Note: For ALL Emergency signals, when changing channels:

- If the new channel is also programmed for Emergency, you can change channels while in Emergency operation. The emergency alarm or call continues on the new channel.
- If the new channel is NOT programmed for Emergency, you hear an invalid tone until you exit the Emergency state or change to a channel programmed for emergency.

Emergency Keep-Alive

With Emergency Keep-Alive enabled, if the radio is in the Emergency state, you cannot turn off the radio by using the **On/Off Volume Control** knob.













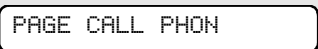

With Keep-Alive, the radio will only exit the Emergency state using one of the ways mentioned in the previous sections (Emergency Alarm, Silent Emergency Alarm, or Emergency Call).

Lists

You can use lists to store frequently used numbers and associate them with names. There are four list types:

- Call
- Page
- Phone
- Scan

View a List

- 1 Press  to find VIEW: 
- 2 Press , , or  directly below VIEW.
- 3 Press  or  to see the names of available lists. 
- 4 Press , , or  directly below the name of the list you wish to view. You see the first list member.  □ indicates the view mode.
- 5 Press  or  to view other list members.
- 6 Press  to exit.

Scan List Empty

If you wish to view a scan list and the list has no entries, you see EMPTY LIST.

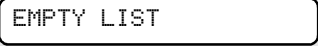

To end this display, turn scan off or edit the list.



Edit a Scan List

This feature lets you change scan list members and priorities.





Use the Menu

1 Press  to find PROG.





2 Press , , or  directly below PROG. You see SCAN.



3 Press , , or  directly below SCAN. You see the first list member.  (flashing) indicates the programming mode.







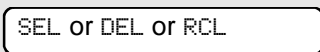

4 Press  or  to find the member you want to change.

5 Press , , or  directly below SEL or DEL or RCL.





SEL = add the currently displayed channel to the scan list.
 DEL = delete the currently displayed channel from the scan list.
 RCL = view the next member of the scan list.

OR

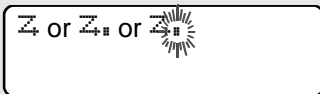
When adding a priority channel, press , , or  below SEL additional times to see  or  or 



 = this channel is in the scan list.
 = this channel is in the scan list as the *priority 2* channel.
 (dot flashing) = this channel is in the scan list as the *priority 1* channel.

OR

When deleting a priority channel, the scan indicator  turns off.

- 6 Press or to select more channels to be added or deleted.

OR

Use the **16-Position Select** knob to select additional channels to be added or deleted.

- 7 Press to exit scan list programming and return to the home display.

Use the Menu and the Preprogrammed Select (Top Side) Button

- 1 Press to find PROG.

PROG

- 2 Press , , or directly below PROG. You see SCAN.

SCAN

- 3 Press , , or directly below SCAN. You see the first list member. (flashing) indicates the programming mode.

FIRE DISP NME

- 4 Press or to find the member you want to change.

- 5 Press the **Select** button one or more times to change the scan list status symbol of the currently displayed channel.



or or or Off

 = this channel is in the scan list.

 = this channel is in the scan list as the *priority 2* channel.

 (dot flashing) = this channel is in the scan list as the *priority 1* channel.

No  = the channel is removed from the scan list.

- 6** Press  or  to select more scan list members whose scan status you want to change.

OR

Use the **16-Position Select** knob to select another scan list member.



- 7** Press  to exit scan list programming and return to the home display.

Use the Preprogrammed Scan List Programming Switch and the Menu

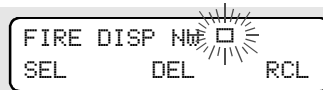
- 1** Move the **Scan List Programming** switch to the **Programming** position. You see the first list member.
 (flashing) indicates the programming mode.



- 2** Press  or  to find the member you want to change.



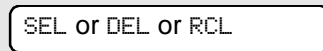



- 3** Press , , or  directly below SEL or DEL or RCL.





SEL = add the currently displayed channel to the scan list.

DEL = delete the currently displayed channel from the scan list.

RCL = view the next member of the scan list.

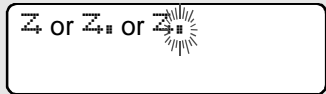
When adding a *priority channel*, press , , or  below SEL additional times to see  or  or 





 = this channel is in the scan list.

 = this channel is in the scan list as the *priority 2* channel.

 (dot flashing) = this channel is in the scan list as the *priority 1* channel.

OR

When deleting a *priority channel*, the scan indicator  turns off.

- 4 Press  or  to select more channels to be added or deleted.

OR

Use the **16-Position Select** knob to select additional channels to be added or deleted.

- 5 Move the **Scan List Programming** switch out of the **Programming** position.

Change the Scan List Status Only

- 1 Move the **Scan List Programming** switch to the **Programming** position. You see the first list member.
□ (flashing) indicates the programming mode.



- 2 Press or to find the member you want to change.

- 3 Press the **Select** button one or more times to change the scan list status symbol of the currently displayed channel.

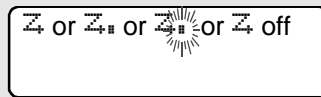

= this channel is in the scan list.

= this channel is in the scan list as the *priority 2* channel.

(dot flashing) = this channel is in the scan list as the *priority 1* channel.

No = the channel is removed from the scan list.

- 4 Press or to select more list members whose scan status you want to change.

OR

You can use the **16-Position Select** knob to select another scan list member.

- 5 Move the **Scan List Programming** switch out of the **Programming** position.

Scan

The scan feature allows you to monitor traffic on different channels by scanning a preprogrammed list of channels. Your radio can have up to 32 different scan lists. These lists must be preprogrammed by a qualified radio technician.

- To view your radio's scan lists, see "View a List" on page 37.
- To change your radio's scan lists, see "Edit a Scan List" on page 38.



Types of Scan Lists

Three types of scan lists are available:

Trunking Priority Monitor	Comprises talkgroups that are all from the same trunking system (10 different talkgroups maximum).
Conventional	Comprises only conventional channels (15 different channels maximum).
Talkgroup Scan	Comprises conventional channels and trunked talkgroups from one trunking system (10 different channels/talkgroups maximum). Priority operation is not available in this type of list.

Types of Scanning

There are also several types of scanning available:

Priority-One Scanning 	One member of the scan list is chosen as the priority-one member. You hear all of the traffic on the priority-one channel, even if the non-priority channels in the scan list have traffic on them.
Priority-Two Scanning  and Non-Priority Scanning 	In addition to the priority-one channel, a second channel can be assigned as a priority-two channel. The remaining members in the scan list can be programmed as non-priority members of the scan list.



Automatic Scanning (Autoscan)	When selected, a channel with autoscan automatically begins scanning its associated scan list. The radio continues auto scanning until you select a channel without autoscan enabled.
Operator-Selectable Scan	Scan can be programmed by a qualified radio technician to be selected by either a menu or a preprogrammed Scan switch.

Turn Scan On or Off

Use the Menu

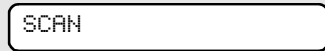
- 1 Press  to find SCAN.







- 2 Press , , or  directly below SCAN. You see the current scan state.

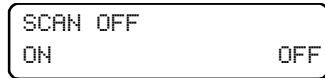

The scan status symbol is displayed when scan is on.

OR



- 3 Press , , or  directly below ON or OFF.



OR

You can press  or the **PTT** button to exit scan and return to the home display without changing the scan state.

Use the Preprogrammed Scan On/Off Switch

Place the **Scan** switch in the **Scan On** or **Scan Off** position. The scan status symbol is displayed when scan is on.



Delete a Nuisance Channel

When the radio scans to a channel that you do not wish to hear (nuisance channel), you can temporarily delete the channel from the scan list.

- 1** When the radio is locked onto the channel to be deleted, press the preprogrammed **Nuisance Delete** button.

Repeat this step to delete more channels.

Note: You cannot delete priority channels or the designated transmit channel.

- 2** The radio continues scanning the remaining channels in the list. To resume scanning the deleted channel, change channels or turn scan off and then back on again.
-

Conventional Scan Only

Make a Dynamic Priority Change

While the radio is scanning, the dynamic priority change feature lets you *temporarily* change any channel in a scan list (except the priority-one channel) to the priority-two channel. The replaced priority-two channel becomes a non-priority channel. This change remains in effect until scan is turned off, then scanning reverts back to the preprogrammed state.

- 1 When the radio is locked onto the channel to be designated as priority-two, press the preprogrammed **Dynamic Priority** button.

Note: The priority-one channel cannot be changed to priority-two.

- 2 The radio continues scanning the remaining channels in the list. To resume scanning the preprogrammed priority-two channel, you must leave and re-enter scan operation.
-

Telephone Calls (ASTRO 25 Trunking Only)

Use your radio to make calls similar to standard phone calls. A landline phone can be used to call a radio, or a radio can be used to call a landline phone.

Quick Access (One-Touch)

If your radio is preprogrammed for Quick Access (One-Touch) Phone Call, you can make a call to *one* preprogrammed phone number without having to select the feature or a phone number.

- 1** Press the **Quick Access Phone** button to dial the phone number.
- 2** If your call is answered, press the **PTT** button to talk; release the **PTT** to listen.
OR
If your call is not answered, go to “Phone Call Display and Alert Prompts” on page 50.
- 3** When your call is completed, press  or the **PTT** button to hang up. The radio returns to the home display.

Answer a Phone Call

Use the preprogrammed **Call Response** button to answer a call.

1 When a phone call is received, you hear a telephone-type ringing, the LED flashes GREEN, the call received symbol (☎) flashes, and PHONE CALL is displayed.

- Telephone-type ringing
- Flashing GREEN LED

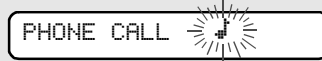

2 Press the **Call Response** button within 20 seconds after the call indicators begin.



3 Press and hold the **PTT** button to talk; release it to listen.

4 Press  to hang up and return to the home display.

Initiate a Phone Call

1 Press  to find PHON.



2 Press , , or  directly below PHON. You see the last transmitted phone number.

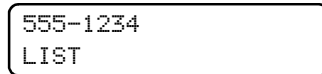

3 Go to "Select a Phone Number," below.

OR

Go to "Make a Phone Call" on page 49.

Select a Phone Number

- 1 Press  to find the phone number you want.

Note: Press LNUM to go to the last number dialed.

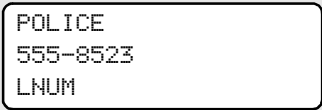

POLICE
555-8523
LNUM

- 2 Go to “Make a Phone Call”, below.
-

Make a Phone Call

- 1 Press and release the **PTT** button to dial the phone number.
- 2 If your call is answered, press the **PTT** button to talk; release the **PTT** to listen.

OR

If your call is not answered, go to “Phone Call Display and Alert Prompts” on page 50.





- 3 When your call is completed, press  to hang up. The radio returns to the home display.
-

Table 7: Phone Call Display and Alert Prompts

<p>When you press the PTT button and the phone system is not available, you hear a long tone. Press  to hang up. The radio returns to the home display.</p>	<div style="border: 1px solid black; border-radius: 10px; padding: 5px; text-align: center; margin-bottom: 10px;">NO PHONE</div> <ul style="list-style-type: none"> • A long tone
<p>When a channel is not available, you hear a busy tone. The radio automatically connects when a channel opens.</p>	<div style="border: 1px solid black; border-radius: 10px; padding: 5px; text-align: center; margin-bottom: 10px;">PHONE BUSY</div> <ul style="list-style-type: none"> • A busy tone
<p>When the phone system is busy, you hear a long tone. Press  to exit the phone mode and try your call later.</p>	<div style="border: 1px solid black; border-radius: 10px; padding: 5px; text-align: center; margin-bottom: 10px;">PHONE BUSY</div> <ul style="list-style-type: none"> • A long tone
<p>The system does not acknowledge your call. Press  to hang up. The radio returns to the home display.</p>	<div style="border: 1px solid black; border-radius: 10px; padding: 5px; text-align: center; margin-bottom: 10px;">NO ACKNOWLEDG</div>
<p>Note: A high-pitched tone, generated when you release the PTT button, indicates to the landline party that he or she may begin talking.</p>	

Enhanced Private Conversation Calls (ASTRO 25 Trunking Only)

These one-to-one calls between two radios are not heard by others in the current talkgroup. The calling radio automatically verifies that the receiving radio is active on the system and can display the caller's ID.

Quick Access (One-Touch)

If your radio is preprogrammed for Quick Access (One-Touch) Private Call, you can make a call to *one* preprogrammed ID number without having to select the feature or an ID number.

- 1 Press the **Quick Access Private Call** button to start the Private Call.

The called ID is momentarily displayed, then you see PLEASE WAIT.

FIRE DEPT
ID: 00722588

PLEASE WAIT

- 2 When you are connected, you see the called ID. Press and hold the **PTT** button to talk; release the **PTT** to listen.

FIRE DEPT
ID: 00722588

OR

If the system does not acknowledge the call, you see NO ACKNOWLEDG.

NO ACKNOWLEDG

OR

If the target radio does not respond before the time out, you see NO ANSWER.

NO ANSWER

- 3 Press  to hang up and return to the home display.

Answer a Private Call

Use the preprogrammed **Call Response** button to answer a call.

- 1 When a Private Call is received, you hear two alert tones, the LED flashes GREEN, the call received symbol (#) flashes, and CALL RECEIVED is displayed.

- Two tones
- Flashing GREEN LED

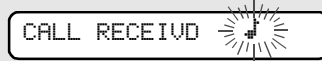

- 2 Press the **Call Response** button within 20 seconds.

If the caller's name is in the call list, it will be displayed during the call.

OR

If the caller's name is not in the call list, the caller's ID number is displayed.



- 3 Press and hold the **PTT** button to talk; release it to listen.

- 4 Press  or the **Call Response** button to hang up and return to the home display.

Initiate a Private Call

- 1 Press  to find CALL.

CALL

- 2 Press , , or  directly below CALL. You see the last transmitted or received ID number.

ID: 00722588
LIST

- 3 Go to “Select an ID Number”, below.

OR

Go to “Make a Private Call” on page 54.

Select an ID Number

- 1 Press  to find the ID number you want.

FIRE CHIEF
ID: 00825682
LNUM

Note: Press LNUM to go to the last number dialed.

- 2 Go to “Make a Private Call” on page 54.

Make a Private Call

1 Press the **PTT** button to start the Private Call.

2 The called ID is momentarily displayed, then you see PLEASE WAIT.

FIRE CHIEF
ID: 00825682

PLEASE WAIT

3 When you are connected, you see the called ID. Press and hold the **PTT** button to talk; release the **PTT** to listen.

FIRE CHIEF
ID: 00825682

OR

If the system does not acknowledge the call, you see NO ACKNOWLEDG.

NO ACKNOWLEDG

OR

If the target radio does not respond before the time out, you see NO ANSWER.

NO ANSWER

4 When your call is completed, press **Ⓜ** to hang up. The radio returns to the home display.

Call Alert Paging (ASTRO 25 Trunking Only)

Call Alert allows your radio to work like a pager. Even if other users are away from their radios, or if they are unable to hear their radios, you can still send them a Call Alert page. You can also verify if a radio is active on the system.

Quick Access (One-Touch)

If your radio is preprogrammed for Quick Access (One-Touch) Call Alert Paging, you can send a page to *one* preprogrammed ID number without having to select the feature or an ID number.

- 1 Press the **Quick Access Call Alert** button to send the Call Alert. You see PLEASE WAIT.

A rectangular display box with rounded corners containing the text "PLEASE WAIT" in a monospaced font.

- 2 When you are connected, you see the home display. Press and hold the **PTT** button to talk; release the **PTT** to listen.

OR

If the system does not acknowledge the call, you see NO ACKNOWLEDG.

A rectangular display box with rounded corners containing the text "NO ACKNOWLEDG" in a monospaced font.



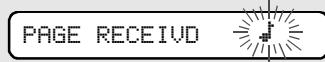

- 3 Press  or the **Call Response** button to hang up and return to the home display.

Answer a Call Alert Page

- 1 When a Call Alert Page is received, you hear four repeating alert tones, the LED flashes GREEN, the call received symbol (#) flashes, and PAGE RECEIVED is displayed.
 - Four repeating alert tones
 - Flashing GREEN LED
- 2 Press and hold the **PTT** button to talk; release it to listen.



Initiate a Call Alert Page

- 1 Press  to find PAGE.
- 2 Press , , or  directly below PAGE. You see the last transmitted or received ID number.
- 3 Go to "Select an ID Number", below.
OR
Go to "Send a Call Alert Page" on page 57.

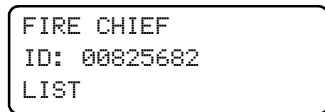
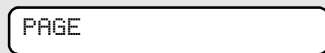

Select an ID Number

- 1 Press  to find the ID number you want.
Note: Press LNUM to go to the last number dialed.
- 2 Go to "Send a Call Alert Page" on page 57.

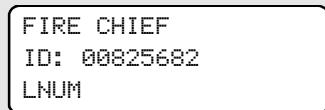

Send a Call Alert Page

- 1 Press the **PTT** button to send the Call Alert to the displayed number. You see **PLEASE WAIT**.

PLEASE WAIT

- 2 When you are connected, you see the home display. Press and hold the **PTT** button to talk; release the **PTT** to listen.

OR

If the system does not acknowledge the call, you see **NO ACKNOWLEDG**.

NO ACKNOWLEDG

- 3 Press **(*)** to hang up and return to the home display.

Conventional Talkgroup Calls (Conventional Operation Only)

Talkgroup Call lets you define a group of conventional system users so that they can share the use of a conventional channel.

Encryption keys are slaved to talkgroups. When talkgroups are enabled, encryption keys are changed by changing the active talkgroup. See “Secure Operations” on page 65.

Select a Talkgroup

- 1 Press to find TGRP.

TGRP

- 2 Press , , or directly below TGRP. You see
The last talkgroup that was selected and stored, and SEL and PSET.

SEL PSET

- 3 Press or to find the talkgroup you want.

- 4 Press , , or directly below SEL or PSET.

SEL PSET

SEL (**SELECT**) — Saves the currently displayed talkgroup and returns to the home display.

PSET (**PRESET**) — Selects the preset preprogrammed talkgroup.

If the encryption key slaved to the new talkgroup is erased, you see **KEY FAIL** and hear a momentary key fail tone.

KEY FAIL

- Momentary key fail tone

If the encryption key that is slaved to the new talkgroup is not allowed, you see **ILLEGAL KEY** and hear a momentary key fail tone.

ILLEGAL KEY

- Momentary key fail tone

- 5 Press  or the **PTT** button, or turn the **16-Position Select** knob to exit.

Status Calls (ASTRO 25 Trunking Only)



You can send data calls to the dispatcher about a predefined status. Each status can have a up to a 12-character name. A maximum of eight status conditions is possible.



Send a Status Call

Use the Menu

- 1 Press  to find STS.



- 2 Press , , or  directly below STS. The last acknowledged status call, or the first status in the list, is displayed.

- 3 Press  or  to find the status you wish to send.

- 4 Press the **PTT** button to send the status.

When the dispatcher acknowledges, four tones sound, **ACK RECEIVED** is displayed, and the radio returns to normal dispatch operation.



- Four tones

OR

If no acknowledgment is received, you will see **NO ACKNOWLEDG** and hear a low-pitched tone.

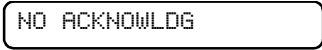

- Single tone

- 5 Press  to go to the home display.

Note: No traffic is heard on trunked channels while Status Calls is selected.
If the radio detects no Status Call activity for six seconds, an alert tone sounds until the **PTT** button is pressed.

Use the Preprogrammed Status Button

- 1 Press the **Status** button. The last acknowledged status call, or the first status in the list, is displayed.
- 2 Press ◀ or ▶ to find the status you wish to send.
- 3 Press the **PTT** button to send the status.

When the dispatcher acknowledges, four tones sound, **ACK RECEIVED** is displayed, and the radio returns to normal dispatch operation.



- Four tones

OR

If no acknowledgment is received, you will see **NO ACKNOWLEDG** and hear a low-pitched tone.



- Single tone

- 4 Press  to go to the home display

Note: No traffic is heard on trunked channels while Status Calls is selected.
If the radio detects no Status Call activity for six seconds, an alert tone sounds until the **PTT** button is pressed.

Repeater or Direct Operation

Also known as “talkaround operation,” DIRECT lets you bypass the repeater and connect directly to another radio. The transmit and receive frequencies are the same.

REPEATER operation increases radio’s range by connecting with other radios through a repeater. The transmit and receive frequencies are different.



Select Repeater or Direct Operation

Use the Menu

- 1 Press  to find DIR.



DIR

- 2 Press , , or  directly below DIR. You momentarily see the current operation.

- For Direct mode

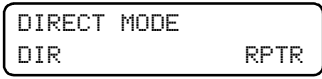

DIRECT MODE
DIR

RPTR

OR

- For Repeater mode

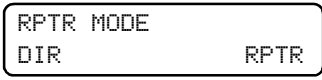

RPTR MODE
DIR

RPTR

- 3 Press , , or  directly below DIR or RPTR.

If DIR is selected, the display shows  and DIRECT MODE.



I+I

DIRECT MODE

OR

Press  to exit without changing the current operation.

Use the Preprogrammed Repeater/Direct Switch

Place the **Repeater/Direct** switch in either the **Repeater** or the **Direct** position. If **DIR** is selected, the display shows **!+!**.



Smart PTT (Conventional Only)

Smart PTT is a per-channel, programmable feature used in conventional radio systems to keep radio users from talking over other radio conversations.

When smart PTT is enabled in your radio, you will not be able to transmit on an active channel. If you try to transmit on an active smart-PTT channel, you will hear an alert tone, and the transmission will be inhibited. The LED will also blink red to indicate that the channel is busy.

Three radio-wide variations of smart PTT are available:

Transmit Inhibit on Busy Channel with Carrier	You cannot transmit if any traffic is detected on the channel.
Transmit Inhibit on Busy Channel with Wrong Squelch Code	You cannot transmit on an active channel with a squelch code or (if secure-equipped) encryption key other than your own. If the PL code is the same as yours, the transmission will not be prevented.
Quick-Key Override	This feature can work in conjunction with either of the two above variations. You can override the transmit-inhibit state by quick-keying the radio. In other words, two PTT Button presses within the preprogrammed time limit.

Special Radio Features

Secure Operations

Secure radio operation provides the highest commercially available level of voice security on both trunked and conventional channels. Unlike other forms of security, Motorola digital encryption provides signaling that makes it virtually impossible for others to decode any part of an encrypted message.

Select Secure Transmissions

Turn the preprogrammed **Secure/Clear** switch to the secure position (Ⓢ).



Note: *If the selected channel is programmed for clear-only operation* — when you press the **PTT** button, you see CLR TX ONLY, and you hear an invalid mode tone.

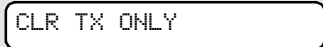

- Invalid mode tone

The radio will not transmit until you set the **Secure/Clear** switch to the clear position (○).

Select Clear Transmissions

Turn the preprogrammed **Secure/Clear** switch to the clear position (○).

Note: *If the selected channel is programmed for secure-only operation* — when you press the **PTT** button, you see SEC TX ONLY, and you hear an invalid mode tone.

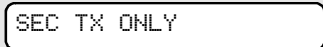

- Invalid mode tone

The radio will not transmit until you set the **Secure/Clear** switch to the secure position (Ⓢ).

PTT ID

Receive

This feature allows you to see the radio ID number of the radio you are currently receiving. This ID can be a maximum of eight characters and can be viewed by both the receiving radio and the dispatcher.

Transmit



Your radio's ID number is automatically sent every time the **PTT** button is pressed. This is a per-channel feature. For digital voice transmissions, your radio's ID is sent continuously during the voice message.

View Your Radio's ID Number

Use the Menu

- 1 Press  to find CALL or PAGE.

CALL or PAGE

- 2 Press , , or 
directly below CALL or PAGE.

- 3 Press .

MY ID:
12345678

Use the Preprogrammed Call or Page Button

- 1 Press the **Call** or **Page** button.

- 2 Press .

MY ID:
12345678

Dynamic Regrouping (ASTRO 25 Trunking Only)

The dynamic regrouping feature lets the dispatcher temporarily reassign selected radios to a single special channel so they can communicate with each other. This feature is typically used during special operations and is enabled by a qualified radio technician. You will not notice whether your radio has this feature enabled until a dynamic regrouping command is sent by the dispatcher.

Note: If you try to access a zone or channel that has been reserved by the dispatcher as a dynamically regrouped mode for other users, you will hear an invalid tone.

When your radio is dynamically regrouped, it automatically switches to the dynamically regrouped channel. You see the dynamically regrouped channel's name, and hear a "gurgle" tone.

Press the **PTT** button to talk; release it to listen.

When the dispatcher cancels dynamic regrouping, the radio automatically returns to the zone and channel that you were using before the radio was dynamically regrouped.



Reprogram Request

This feature lets you notify the dispatcher that you want a new dynamic regrouping assignment.

Use the Menu

1 Press  to find **RPGM**.

RPGM

2 Press , , or  directly below **RPGM**.

REPRGRM RQST

The reprogram request is sent to the dispatcher.

3 If you hear *one beep* • One beep

- Press the **PTT** button to send the reprogram request again.

OR

- Press  to cancel and return to the home display.

OR

If you hear *five beeps*, the reprogram request was acknowledged by the dispatcher. Your radio returns to the home display.

- Five beeps

OR

If the dispatcher does not acknowledge the reprogram request within six seconds, you see **NO ACKNOWLEDG** and hear a low-pitched alert tone.

NO ACKNOWLEDG

- An alert tone

Try again or press .

Use the Preprogrammed Reprogram Request Button

1 Press the **Reprogram Request** button. You see **REPRGRM RQST**.

REPRGRM RQST

The reprogram request is sent to the dispatcher.

2 If you hear *one beep*

- Press the **PTT** button to send the reprogram request again

OR

- Press  to hang up and return to the home display.

OR

If you hear *five beeps*, the reprogram request was acknowledged by the dispatcher. Your radio returns to the home display.

OR

If the dispatcher does not acknowledge the reprogram request within six seconds, you see **NO ACKNOWLEDG** and hear a low-pitched alert tone.

NO ACKNOWLEDG

- An alert tone

Try again or press .

Select Enable / Disable

The dispatcher can classify reprogrammed radios into either of two categories: Select Enabled or Select Disabled.

- Select-enabled radios are free to change to any available channel, including the dynamic-regrouping channel, once the user has selected the dynamic-regrouping position.
- Select-disabled radios cannot change channels while dynamically regrouped. The dispatcher has forced the radio to remain on the dynamic-regrouping channel.

The Scan or Private Conversation call feature cannot be selected while your radio is Select Disabled.

Trunking System Controls

Failsoft

The Failsoft system ensures continuous radio communications during a trunked system failure. If a trunking system fails completely, the radio goes into failsoft operation and automatically switches to its failsoft channel.

During failsoft operation:

Your radio transmits and receives in conventional operation on a predetermined frequency.

FAILSOFT

You hear a medium-pitched tone every 10 seconds.

- A medium-pitched tone

When the trunking system returns to normal operation, your radio automatically leaves failsoft operation and returns to trunked operation.

Out-of-Range

If you go out of the range of the system and can no longer lock onto a control channel:

You see the currently selected zone/channel combination and OUT OF RANGE.

OUT OF RANGE

— *and/or* —

— *and/or* —

You hear a low-pitched tone.

- A tone

Your radio remains in this out-of-range condition until it locks onto a control channel, or it locks onto a failsoft channel, or it is turned off.

- Locks onto a control channel, or
- Locks onto a failsoft channel, or
- Turned off.

Site Lock

This feature allows your radio to lock onto a specific site and not roam among wide-area talkgroup sites. This feature should be used with caution, since it inhibits roaming to another site in a wide-area system.



Lock or Unlock a Site

Use the Menu

- 1 Press  to find SITE.



SITE

- 2 Press , , or  directly below SITE. The current lock state is displayed.

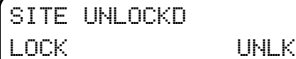



SITE UNLOCKD
LOCK UNLK

OR



SITE LOCKED
LOCK UNLK

- 3 Press , , or  directly below the desired lock state, LOCK or UNLK. The new site-lock state is saved, and your radio returns to the home display.

- The new site-lock state is saved.
- Your radio returns to the home display.

Use the Preprogrammed Site Lock/Unlock Button

- 1 Press the **Site Lock/Unlock** button. The current lock state is momentarily displayed.

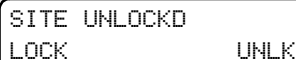

SITE UNLOCKD
LOCK UNLK

OR



SITE LOCKED
LOCK UNLK

- 2 Press and hold the **Site Lock/Unlock** button to find the desired lock state, `SITE UNLOCKD` or `SITE LOCKED`.

Site Trunking

If the zone controller loses communication with any site, that site reverts to site trunking.

You see the currently selected zone/channel combination and `SITE TRUNKNG`.



`SITE TRUNKNG`

When this occurs, you can communicate only with other radios within your trunking site.

Site View and Change

You can view the number of the current site or force your radio to change to a new one.

View the Current Site

Press the preprogrammed **Site Search** button.



The display momentarily shows the name of the current site and its corresponding received signal strength indicator (RSSI).

OR

If the radio is scanning for a new site, you momentarily see SCANNING SITE.

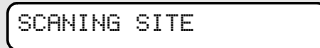

Change the Current Site

Press and hold down the preprogrammed **Site Search** button. You momentarily see SCANNING SITE and hear a tone.

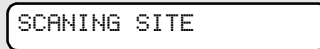

- A tone

When the radio finds a new site, it returns to the home display.

Time and Date

Using this special feature, you can program the time and date as you might with other electronic devices. The clock display is enabled by a qualified radio technician.

- The default time setting is a 12-hour clock.

12HR 00:00AM



- If a 24-hour clock is selected, AM/PM selection is not available.
- The default setting for the domestic date shows MDY.

MDY 00/00/00

Edit the Time and Date



- 1 Press  to find CLCK.

CLCK

- 2 Press , , or  directly below CLCK. The current setting is displayed.

12HR 03:54AM
MDY 03/07/01

EDIT

- 3 Press , , or  directly below EDIT. The first item flashes.

 12HR 03:54AM
MDY 03/07/01

SAVE

- 4 Press  or  to change the selected item.

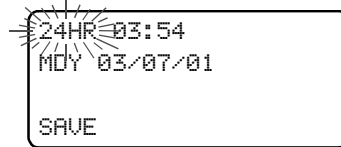



Note: Press  at any time to return to the home display without saving your changes.

OR

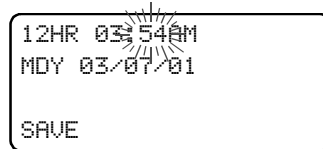
Press  one or more times to move to an item you wish to change.



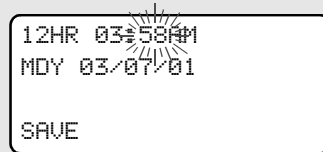

- 5 Press  or  to change the selected item.









- 6 Press  one or more times to move to an item in the date field.



- 7 Press  or  to change the selected item.



- 8** When you have made all your changes, press , , or  directly below **SAVE** to save your changes and return to the home display.

Note: When you have made all your changes, press , , or  directly below **SAVE** to save your changes and return to the home display.

Notes

Helpful Tips

Radio Care

Things to Avoid



Caution

- The XTS 5000 radio casing has two vent ports that allow for pressure equalization in the radio. Never poke these vents with any objects, such as needles, tweezers, or screwdrivers. This could create leak paths into the radio and the radio's submergibility will be lost.
- **(For XTS 5000 R Radios Only)** The XTS 5000 R radio is designed to be submerged to a maximum depth of 6 feet, with a maximum submersion time of 4 hours. Exceeding either maximum limit may result in damage to the radio.
- If the radio battery contact area has been submerged in water, dry and clean the radio battery contacts before attaching a battery to the radio. Otherwise, the water could short-circuit the radio.
- If the radio has been submerged in water, shake the radio well so that any water that may be trapped inside the speaker grille and microphone port can be removed. Otherwise, the water will decrease the audio quality of the radio.
- Do not disassemble the radio. This could damage radio seals and result in leak paths into the radio. Any radio maintenance should be performed only by a qualified radio technician.

Cleaning

To clean the external surfaces of your radio:

- 1 Combine one teaspoon of mild dishwashing detergent to one gallon of water (0.5% solution).
- 2 Apply the solution sparingly with a stiff, non-metallic, short-bristled brush, making sure excess detergent does not get entrapped near the connectors, controls or crevices. Dry the radio thoroughly with a soft, lint-free cloth.
- 3 Clean battery contacts with a lint-free cloth to remove dirt or grease.



Caution

Do not use solvents to clean your radio. Spirits may permanently damage the radio housing.

Do not submerge the radio in the detergent solution.

Handling

- Do not pound, drop, or throw the radio unnecessarily. Never carry the radio by the antenna.
- Avoid subjecting the radio to an excess of liquids. Do not submerge the radio unless it is a ruggedized, XTS 5000 R model.
- Avoid subjecting the radio to corrosives, solvents or spirits.
- Do not disassemble the radio.
- Keep the accessory-connector cover in place until ready to use the connector. Replace the cover immediately once the accessory has been disconnected.

Service

Proper repair and maintenance procedures will assure efficient operation and long life for this product. A Motorola maintenance agreement will provide expert service to keep this and all other communication equipment in perfect operating condition. A nationwide service organization is provided by Motorola to support maintenance services. Through its maintenance and installation program, Motorola makes available the finest service to those desiring reliable, continuous communications on a contract basis. For a contract service agreement, please contact your nearest Motorola service or sales representative, or an authorized Motorola dealer.

Express Service Plus (ESP) is an optional extended service coverage plan, which provides for the repair of this product for an additional period of either one or two years beyond the normal expiration date of the standard warranty. For more information about ESP, contact the Motorola Radio Support Center at 3761 South Central Avenue, Rockford, IL 61102 (800) 227-6772 / (847)725-4200.

Battery

Battery Life

Battery life is determined by several factors. Among the more critical are the regular overcharge of batteries and the average depth of discharge with each cycle. Typically, the greater the overcharge and the deeper the average discharge, the fewer cycles a battery will last. For example, a battery which is overcharged and discharged 100% several times a day, will last fewer cycles than a battery that receives less of an overcharge and is discharged to 50% per day. Further, a battery which receives minimal overcharging and averages only 25% discharge, will last even longer.

Charging the Battery

Motorola batteries are designed specifically to be used with a Motorola charger and vice-versa. Charging in non-Motorola equipment may lead to battery damage and void the battery warranty. Motorola-authorized battery chargers may not charge batteries other than the ones listed on page 87.

The battery should be at about 77°F (25°C) (room temperature), whenever possible. Charging a cold battery (below 50° F [10°C]) may result in leakage of electrolyte and ultimately in failure of the battery. Charging a hot battery (above 95°F [35°C]) results in reduced discharge capacity, affecting the performance of the radio. Motorola rapid-rate battery chargers contain a temperature-sensing circuit to ensure that batteries are charged within the temperature limits stated above.

Battery Charge Status

Your radio can indicate your battery's charge status through:

- LED and sounds
- conventional fuel gauge symbol on the display
- smart fuel gauge symbol on the display

LED and Sounds

When your battery is low:





- you see the LED flash red when the **PTT** button is pressed
- you hear a low-battery “chirp” (short, high-pitched tone)

Conventional Fuel Gauge Symbol

A flashing fuel gauge symbol () is displayed only when the battery voltage drops to low level. In this case, replace the battery with a fully charged one.

Smart Fuel Gauge Symbol

Consult the Smart Battery manual. All conditions must be met for a battery to be classified as a “Smart Battery.” When your radio has a Smart Battery installed, the fuel gauge symbol is always displayed:

Gauge shows	if the battery's charge is
	71% to 100% full
	41% to 70%
	11% to 40%
	10% or less (at 10%, the gauge begins flashing)

Replace the battery with a fully charged one when the fuel gauge shows the lowest level.

Battery Recycling and Disposal

Nickel-cadmium (NiCd) rechargeable batteries can be recycled. However, recycling facilities may not be available in all areas. Under various U.S. state laws and the laws of several other countries, NiCd batteries must be recycled and cannot be disposed of in landfills or incinerators. Contact your local waste management agency for specific requirements and information in your area.

Motorola fully endorses and encourages the recycling of NiCd batteries. In the U.S. and Canada, Motorola participates in the

Helpful Tips

nationwide Rechargeable Battery Recycling Corporation (RBRC) program for NiCd battery collection and recycling. Many retailers and dealers participate in this program.

For the location of the drop-off facility closest to you, access RBRC's Internet web site at www.rbrc.com or call 1-800-8-BATTERY. This internet site and telephone number also provide other useful information concerning recycling options for consumers, businesses, and governmental agencies.

Antenna

Radio Operating Frequencies

Before installing the antenna, make sure it matches your radio's operating frequency. Antennas are frequency sensitive and are color coded according to their frequency range. The color code indicator is located in the center of the antenna's base.

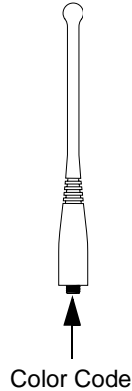

The following antenna types are compatible with your radio:

Antenna type	Approx. length		Insulator color code	Frequency range	Antenna kit no.
	in.	mm			
800MHz Whip, Halfwave	7	175	RED	806-870 MHz	NAF5037
800MHz Stubby, Quarterwave	3.3	83	WHITE	806-870 MHz	NAF5042
700/800MHz Whip	7	185	GREEN	764-870 MHz	NAF5080

Notes

Accessories

Motorola provides the following approved accessories to improve the productivity of your XTS 5000 portable two-way radio.

Antennas

NAF5037	800 MHz Whip, Halfwave (806-870 MHz)
NAF5042	800 MHz Stubby, Quarterwave (806-870 MHz)
NAF5080	700/800 MHz Whip (764-870 MHz)

Batteries

HNN9031	1525 NiCd smart
HNN9032	1525 NiCd smart
NTN8294	NiCd, Ultra-High Capacity
NTN8295	1525 NiCd high-capacity Factory Mutual Intrinsically Safe
NTN8297	1525 NiCd high-capacity Factory Mutual Intrinsically Safe, Rugged
NTN8299	1750 NiMH ultra-capacity FM
NTN8610	1650 Lithium Ion
NTN8923	1800 NiMH ultra-capacity
NTN9177	Battery Holder, Clamshell Black
NTN9183	Battery Holder, Clamshell Orange, same as NTN9177
NTN9533	2400 Lithium Ion smart
NTN9862	2000 Lithium Ion smart, slim
RNN4006	3000 NiMH
RNN4007	3000 NiMH FM

Carry Accessories

Belt Clips

NTN8266	Belt Clip Kit (Compatible with Clamshell Batteries)
---------	---

Belt Loops

NTN8040	Belt Loop, Swivel, Leather, 3.0", High-Activity (For use only with the high-activity leather swivel snap carry cases.)
---------	--

Carry Cases

NTN8381	Leather High Activity, 3.0", Swivel Belt Loop, Model II and III Radios
---------	--

Chargers

NTN1873	Single-Unit, Dual Rate, Rapid, Tri-Chemistry; 110 V
NTN1874	Single-Unit, Dual Rate, Rapid, Tri-Chemistry; 220 V (2-prong Euro plug)
NTN1875	Single-Unit, Dual Rate, Rapid;, Tri-Chemistry 240 V (3-prong UK plug)
NTN1177	Multi-Unit, Dual Rate, Rapid: 110 V
NTN1178	Multi-Unit, Dual Rate, Rapid: 220 V (2-prong Euro plug)
NTN1179	Multi-Unit, Dual Rate, Rapid: 240V (UK 13 MAP Plug)
NTN1667	Single-Unit, Tri-Chemistry, Rapid Rate,110 V
NTN1668	Single-Unit, Tri-Chemistry, Rapid Rate, 230 V (2-prong Euro Plug)

NTN1669	Single-Unit, Tri-Chemistry, Rapid Rate, 230 V (3-prong UK Plug)
NTN4796	Multi-Unit, Tri-Chemistry, Rapid Rate, 110 V
NTN9176	Vehicular, Tri-Chemistry and compatible with PAC•RT
WPLN4111	Impres™ Single-Unit, Tri-Chemistry, 110 V

Enhanced and Multi-Unit Line Cords

NTN7373	110 V Interchangeable Line
NTN7374	220 V Interchangeable Line (2 prong Euro plug)
NTN7375	240 V Interchangeable Line (3 prong UK plug)

Headset / Surveillance Accessories

BDN6645	Noise-Canceling Boom Mic Headset with PTT on earcup
NMN6258	Over the Head Headset w/ In Line PTT

Earpieces

BDN6641	Ear mic, high noise level up to 105dB GREY (must order Interface module)
BDN6677	Ear mic, standard, noise up to 95dB BLACK (must order Interface module)

Headset Accessories

BDN6635	Heavy-Duty VOX Headset with Noise-Cancelling Boom Mic (Requires BDN6673_)
BDN6636	Heavy-Duty VOX Headset with Throat Microphone (Requires BDN6673_)
BDN6673	Cable, Headset Adapter

Accessories

NMN6259	Medium Weight, Behind-the-Head with In-Line PTT Switch
RMN4049	Temple Transducer

Ear Microphones (Require Radio Interface Module)

BDN6677	Ear Mic, Standard — 95 dB (Black)
BDN6678	Ear Mic, Standard — 95 dB (Beige)

Radio Interface Modules for Ear Microphones

BDN6671	Voice-activated Interface Module
BDN6708	Push-to-Talk Interface Module

Remote Speaker and Public Safety Microphones

NMN6191	RSM Noise Canceling Includes: 6.0' coiled cord assembly, 3.5mm earjack, swivel clip, quick disconnect
NMN6193	Remote Speaker Mic

Vehicular Adapters

Accessories

HMN4069	Next-Generation Mobile Mic
HSN1006	Speaker, 6-Watt
NKN6455	Cable, 6-Watt Speaker
NTN1606	Vehicular Adapter, BNC, Open Face
NTN1607	Vehicular Adapter, BNC, Closed Face
NTN8270	Tool Wrench
NTN8480	Vehicular Adapter Trunion Kit

NTN8560	Vehicular Adapter, Mini-U, Open Faced
NTN8561	Vehicular Adapter, Mini-U, Closed Faced
NTN9176	Vehicular Charger, XTS
PLN7737	Handheld Control Head

Allied Models



N1799	Vehicular Adapter, Mini-U, Closed Faced
N2001	Vehicular Adapter, Mini-U, Open Face
N2002	Vehicular Adapter, BNC, Open Face
N2003	Vehicular Adapter, BNC, Closed Face

Notes

Glossary

This is a list of specialized terms used in this manual.

ACK	Acknowledgment of communication.
Active Channel	A channel that has traffic on it.
Analog Signal	An RF signal that has a continuous nature rather than a pulsed or discrete nature.
Call Alert	Privately page an individual by sending an audible tone.
Carrier Squelch	Feature that responds to the presence of an RF carrier by opening or unmuting (turning on) a receiver's audio circuit. A squelch circuit silences the radio when no signal is being received so that the user does not have to listen to "noise."
Central Controller	A software controlled, computer-driven device that receives and generates data for the trunked radios assigned to it. It monitors and directs the operations of the trunked repeaters.
Channel	A group of characteristics such as transmit/receive frequency pairs, radio parameters, and encryption encoding.
Control Channel	In a trunking system, one of the channels that is used to provide a continuous, two-way/data communications path between the central controller and all radios on the system.
Conventional	Typically refers to radio-to-radio communications, sometimes through a repeater (See Trunking).
Cursor	A visual tracking marker (a blinking line) that indicates a location on the display.

Deadlock	Displayed by the radio after three failed attempts to unlock the radio. The radio must be powered off and on prior to another attempt.
Digital Private Line (DPL)	A type of coded squelch using data bursts. Similar to PL except a digital code is used instead of a tone.
Digital Signal	An RF signal that has a pulsed, or discrete, nature, rather than a continuous nature.
Dispatcher	An individual who has radio system management duties.
Failsoft	A feature that allows communications to take place even though the central controller has failed. Each trunked repeater in the system will transmit a data word informing every radio that the system has gone into failsoft.
FCC	Federal Communications Commission.
Hang Up	Disconnect.
Home Display	The first display information after the radio completes its self test.
LCD	Liquid crystal display.
LED	Light-emitting diode.
Menu Entry	A software-activated feature shown at the bottom of the display — selection of these features is controlled by the  ,  , and  buttons.
Monitor	Check channel activity by pressing the Monitor button. If the channel is clear, you will hear static. If the channel is in use, you will hear conversation. It also serves as a way to check the volume level of the radio, since the radio will “open the squelch” when pressing the monitor button.

Network Access Code	Network Access Code (NAC) operates on digital channels to reduce voice channel interference between adjacent systems and sites.
NiCd	Nickel-cadmium.
NiMH	Nickel-metal-hydride.
Non-tactical/Revert	The user will talk on a preprogrammed emergency channel. The emergency alarm is sent out on this same channel.
Page	A one-way alert, with audio and/or display messages.
Personality	A set of unique features specific to a radio.
Preprogrammed	A software feature that has been activated by a qualified radio technician.
Private (Conversation) Call	A feature that lets you have a private conversation with another radio user in the group.
Private Line (PL)	A sub-audible tone that is transmitted such that only receivers decoding the tone will receive it.
Programmable	A radio control that can have a radio feature assigned to it.
PTT	Push-To-Talk — the PTT button engages the transmitter and puts the radio in transmit (send) operation when pressed.
Radio Frequency (RF)	The part of the general frequency spectrum between the audio and infrared light regions (about 10 kHz to 10,000,000 MHz).
Repeater	A conventional radio feature, where you talk through a receive/transmit facility that re-transmits received signals, in order to improve communications range and coverage.

Selective Switch	Any digital P25 traffic having the correct Network Access Code and the correct talkgroup.
Squelch	Special electronic circuitry, added to the receiver of a radio, that reduces, or cuts off, unwanted signals before they are heard in the speaker.
Standby	An operating condition whereby the radio's speaker is muted but still continues to receive data.
Status Calls	Pre-defined text messages that allow the user to send a conditional message without talking.
Tactical/Non-revert	The user will talk on the channel that was selected before the radio entered the emergency state.
Talkaround	Bypass a repeater and talk directly to another unit for easy local unit-to-unit communications.
Talkgroup	An organization or group of radio users who communicate with each other using the same communication path.
Trunking	The automatic sharing of communications paths between a large number of users (See Conventional).
Zone	A grouping of channels.

Commercial Warranty

Limited Warranty

MOTOROLA COMMUNICATION PRODUCTS

I. WHAT THIS WARRANTY COVERS AND FOR HOW LONG:

MOTOROLA INC. (“MOTOROLA”) warrants the MOTOROLA manufactured Communication Products listed below (“Product”) against defects in material and workmanship under normal use and service for a period of time from the date of purchase as scheduled below:

ASTRO XTS 5000 Portable Units	One (1) Year
Product Accessories	One (1) Year

Motorola, at its option, will at no charge either repair the Product (with new or reconditioned parts), replace it (with a new or reconditioned Product), or refund the purchase price of the Product during the warranty period provided it is returned in accordance with the terms of this warranty. Replaced parts or boards are warranted for the balance of the original applicable warranty period. All replaced parts of Product shall become the property of MOTOROLA.

This express limited warranty is extended by MOTOROLA to the original end user purchaser only and is not assignable or transferable to any other party. This is the complete warranty for the Product manufactured by MOTOROLA. MOTOROLA assumes no obligations or liability for additions or modifications to this warranty unless made in writing and signed by an officer of MOTOROLA. Unless made in a separate agreement between MOTOROLA and the original end user purchaser, MOTOROLA does not warrant the installation, maintenance or service of the Product.

MOTOROLA cannot be responsible in any way for any ancillary equipment not furnished by MOTOROLA which is attached to or used in connection with the Product, or for operation of the Product with any ancillary equipment, and all such equipment is expressly excluded from this warranty. Because each system which may use

the Product is unique, MOTOROLA disclaims liability for range, coverage, or operation of the system as a whole under this warranty.

II. GENERAL PROVISIONS:

This warranty sets forth the full extent of MOTOROLA'S responsibilities regarding the Product. Repair, replacement or refund of the purchase price, at MOTOROLA's option, is the exclusive remedy. THIS WARRANTY IS GIVEN IN LIEU OF ALL OTHER EXPRESS WARRANTIES. IMPLIED WARRANTIES, INCLUDING WITHOUT LIMITATION, IMPLIED WARRANTIES OF MERCHANTABILITY AND FITNESS FOR A PARTICULAR PURPOSE, ARE LIMITED TO THE DURATION OF THIS LIMITED WARRANTY. IN NO EVENT SHALL MOTOROLA BE LIABLE FOR DAMAGES IN EXCESS OF THE PURCHASE PRICE OF THE PRODUCT, FOR ANY LOSS OF USE, LOSS OF TIME, INCONVENIENCE, COMMERCIAL LOSS, LOST PROFITS OR SAVINGS OR OTHER INCIDENTAL, SPECIAL OR CONSEQUENTIAL DAMAGES ARISING OUT OF THE USE OR INABILITY TO USE SUCH PRODUCT, TO THE FULL EXTENT SUCH MAY BE DISCLAIMED BY LAW.

III. STATE LAW RIGHTS:

SOME STATES DO NOT ALLOW THE EXCLUSION OR LIMITATION OF INCIDENTAL OR CONSEQUENTIAL DAMAGES OR LIMITATION ON HOW LONG AN IMPLIED WARRANTY LASTS, SO THE ABOVE LIMITATION OR EXCLUSIONS MAY NOT APPLY.

This warranty gives specific legal rights, and there may be other rights which may vary from state to state.

IV. HOW TO GET WARRANTY SERVICE:

You must provide proof of purchase (bearing the date of purchase and Product item serial number) in order to receive warranty service and, also, deliver or send the Product item, transportation and insurance prepaid, to an authorized warranty service location. Warranty service will be provided by Motorola through one of its authorized warranty service locations. If you first contact the company

which sold you the Product, it can facilitate your obtaining warranty service. You can also call Motorola at 1-888-567-7347 US/Canada.

V. WHAT THIS WARRANTY DOES NOT COVER:

- A) Defects or damage resulting from use of the Product in other than its normal and customary manner.
- B) Defects or damage from misuse, accident, water, or neglect.
- C) Defects or damage from improper testing, operation, maintenance, installation, alteration, modification, or adjustment.
- D) Breakage or damage to antennas unless caused directly by defects in material workmanship.
- E) A Product subjected to unauthorized Product modifications, disassemblies or repairs (including, without limitation, the addition to the Product of non-Motorola supplied equipment) which adversely affect performance of the Product or interfere with Motorola's normal warranty inspection and testing of the Product to verify any warranty claim.
- F) Product which has had the serial number removed or made illegible.
- G) Rechargeable batteries if:
 - any of the seals on the battery enclosure of cells are broken or show evidence of tampering.
 - the damage or defect is caused by charging or using the battery in equipment or service other than the Product for which it is specified.
- H) Freight costs to the repair depot.
- I) A Product which, due to illegal or unauthorized alteration of the software/firmware in the Product, does not function in accordance with MOTOROLA's published specifications or the FCC type acceptance labeling in effect for the Product at

the time the Product was initially distributed from MOTOROLA.

- J) Scratches or other cosmetic damage to Product surfaces that does not affect the operation of the Product.
- K) Normal and customary wear and tear.

VI. PATENT AND SOFTWARE PROVISIONS:

MOTOROLA will defend, at its own expense, any suit brought against the end user purchaser to the extent that it is based on a claim that the Product or parts infringe a United States patent, and MOTOROLA will pay those costs and damages finally awarded against the end user purchaser in any such suit which are attributable to any such claim, but such defense and payments are conditioned on the following:

- A) that MOTOROLA will be notified promptly in writing by such purchaser of any notice of such claim;
- B) that MOTOROLA will have sole control of the defense of such suit and all negotiations for its settlement or compromise; and
- C) should the Product or parts become, or in MOTOROLA's opinion be likely to become, the subject of a claim of infringement of a United States patent, that such purchaser will permit MOTOROLA, at its option and expense, either to procure for such purchaser the right to continue using the Product or parts or to replace or modify the same so that it becomes non-infringing or to grant such purchaser a credit for the Product or parts as depreciated and accept its return. The depreciation will be an equal amount per year over the lifetime of the Product or parts as established by MOTOROLA.

MOTOROLA will have no liability with respect to any claim of patent infringement which is based upon the combination of the Product or parts furnished hereunder with software, apparatus or devices not furnished by MOTOROLA, nor will MOTOROLA have any liability for

the use of ancillary equipment or software not furnished by MOTOROLA which is attached to or used in connection with the Product. The foregoing states the entire liability of MOTOROLA with respect to infringement of patents by the Product or any parts thereof.

Laws in the United States and other countries preserve for MOTOROLA certain exclusive rights for copyrighted MOTOROLA software such as the exclusive rights to reproduce in copies and distribute copies of such Motorola software. MOTOROLA software may be used in only the Product in which the software was originally embodied and such software in such Product may not be replaced, copied, distributed, modified in any way, or used to produce any derivative thereof. No other use including, without limitation, alteration, modification, reproduction, distribution, or reverse engineering of such MOTOROLA software or exercise of rights in such MOTOROLA software is permitted. No license is granted by implication, estoppel or otherwise under MOTOROLA patent rights or copyrights.

VII. GOVERNING LAW:

This Warranty is governed by the laws of the State of Illinois, USA.

Notes

Index

Numerics

4-way navigation button 8

A

accessories 87

alert tones 10

alpha button 8

antenna

attaching..... 16

radio operating frequencies 85

removing 16

antennas 87

attach

the antenna 16

the battery 14

the belt clip 17

the universal connector cover . 18

B

backlight 5

batteries 87

battery

attaching 14

charge status

checking 13

conventional fuel gauge

symbol 83

LED and sounds 83

smart fuel gauge symbol 83

charger 13

charging 13, 82

life 82

recycling and disposal 83

belt clip, attaching 17

C

call alert paging

answer a call alert page 56

initiate a call alert page 56

quick access (one-touch) 55

select an ID number 56

send a call alert page 57

carry accessories

belt clips 88

belt loops 88

carry cases 88

chargers

enhanced and multi-unit line

cords 89

charging the battery 13

common radio features 27

conventional

mode operation 25

squelch operation

analog options 30

digital options 30

talkgroup calls, select a

talkgroup..... 58

D

display 4

dynamic regrouping 68

E

edit a scan list

change the scan list status

only 42

use the menu 38

use the menu and the

preprogrammed select

button 39

use the preprogrammed scan list

programming switch and the

menu 40

electromagnetic interference/

compatibilityix

emergency

keep alive 36

send a silent emergency

alarm 35

send an emergency alarm 33

send an emergency call 34

F

failsoft71

G

general radio operation1
glossary93

H

headset / surveillance accessories
 ear microphones90
 earpieces89
 headset accessories89
 radio interface modules for ear
 microphones90
 remote speaker and public
 safety microphones90
helpful tips79
home button8

I

intrinsically safe radio information xii

L

LED indicators9
lists
 scan list empty37
 view37
lock or unlock a site
 use the menu72
 use the preprogrammed site lock/
 unlock button72

M

menu
 entry (softkey)7
 entry features8
 select buttons7
mute or unmute keypad tones
 use the menu29
 use the preprogrammed keypad
 mute button29

N

notations used in this manual1

O

operational warnings xi
out-of-range71

P

phone call display and alert
 prompts49, 50
physical features of the XTS 5000
 model II radio3
PL defeat31
private calls
 answer a private call52
 initiate53
 make a private call54
 quick access (one-touch)51
 select an ID number53
programmable controls3
PTT ID
 receive66
 transmit66

R

radio
 care
 cleaning80
 handling80
 things to avoid79
 on and off19
receive / transmit
 use preprogrammed monitor
 button24
 use preprogrammed volume set
 button23
 without using volume set and
 monitor buttons23
remove
 the antenna16
 the battery14
 the belt clip17

-
- the universal connector cover . 18
 - repeater or direct operation 62
 - reprogram request
 - use the menu 68
 - use the preprogrammed
 - reprogram request button 69
 - request a new dynamic regrouping,
 - using the menu 68
- S**
- scan
 - delete a nuisance channel 45
 - types of scan lists 43
 - types of scanning 43
 - scan (conventional only), make a
 - dynamic priority change 46
 - secure operations 65
 - select
 - a channel
 - method 1 use the 16-position
 - select knob 21
 - method 2 use the menu 21
 - a zone
 - use the menu 20
 - use the preprogrammed zone
 - switch 20
 - clear transmissions 65
 - enable / disable 70
 - repeater or direct operation
 - use the menu 62
 - use the preprogrammed
 - repeater/direct switch 63
 - secure transmissions 65
 - selectable power level
 - use the menu 27
 - use the preprogrammed transmit
 - power level switch 28
 - send a status call
 - use the menu 60
 - use the preprogrammed
 - status button 61
 - site
 - lock 72
 - trunking 73
 - view and change
 - change the current site 74
 - view the current site 74
 - smart
 - battery condition
 - use the menu 15
 - use the preprogrammed
 - smart battery button 15
 - PTT (conventional only) 64
 - special radio features 65
 - standard accessories 13
 - status
 - calls 60
 - symbols 5
- T**
- telephone calls
 - answer a phone call 48
 - initiate 48
 - make a phone call 49
 - quick access (one-touch) 47
 - select a phone number 49
 - text 7
 - time and date, edit 75
 - time-out timer 32
 - trunking system controls 71
 - turn
 - scan on or off
 - use the menu 44
 - using the preprogrammed scan
 - switch 44
 - the radio off 19
 - the radio on 19
- U**
- universal connector cover,
 - attaching 18
- V**
- vehicular adaptors
 - accessories 90

Index

allied models91
view your radio's ID number
 use the menu67
 use the preprogrammed call or
 page button67

W

warranty97

Y

your XTS 5000 model II radio2

Z

zones and channels20

Motorola, Inc.
8000 West Sunrise Boulevard
Ft. Lauderdale, FL 33322



68P81094C26-A