



2' x 2' LED PANEL



PROJECT	
TYPE	PART#

PRODUCT FEATURES

- Plug & Play 24 Volt design for quick install and design flexibility
- Constant voltage design allows multiple lights per driver and greater energy efficiency
- Dimmable (0-10V or PWM)
- Polycarbonate diffuser will not shatter, sag or yellow
- 100% acrylic light guide panel for color stability
- Edge-lit design for ultra thin profile (3/8")
- Wide 120° beam angle for better spacing
- Lights can be located up to 50' from driver
- IP44 rating for damp or dry locations
- IC rating permits contact with insulation
- Rated for over 50,000 hours LM-70
- Panels may be grid, flush or surface mounted
- Install with TILT® Drivers and Wired Components



PART NUMBER & PRODUCT GUIDE (2' X 2' LED PANEL)

Grid Mount Part#	Flush Mount Part#	Description	Color Temp	CRI	R9	Lumens	AC Watts	DC Watts	L/W-DC
LGM2230W-HE	LFM2230W-HE	2'X2' LED Panel	3000K	>80	>5	3650	35	30	121
LGM2235W-HE	LFM2235W-HE	2'X2' LED Panel	3500K	>80	>5	3750	35	30	125
LGM2240W-HE	LFM2240W-HE	2'X2' LED Panel	4000K	>80	>5	3800	35	30	124
LGM2250W-HE	LFM2250W-HE	2'X2' LED Panel	5000K	>80	>5	3850	35	30	126
LGM2230W-CQ*	LFM2230W-CQ*	2'X2' LED Panel	3000K	>90	>50	3650	44	38	96
LGM2235W-CQ*	LFM2235W-CQ*	2'X2' LED Panel	3500K	>90	>50	3750	44	38	98
LGM2240W-CQ*	LFM2240W-CQ*	2'X2' LED Panel	4000K	>90	>50	3800	44	38	100
LGM2250W-CQ*	LFM2250W-CQ*	2'X2' LED Panel	5000K	>90	>50	3850	44	38	101

• HE Model is designed to provide a balance of light quality and energy efficiency.

• CQ Model is designed to provide high color rendering with a more complete spectral distribution.

• For surface mount application: Use Grid Mount product with surface mount accessory.

* CQ Model orders may have minimum order quantity required and additional lead time. Contact Lauren Illumination for details.

DRIVER SPECIFICATIONS

Part #	Size (WxLxD)	AC Input	DC Output	Working Temp	Max Lights/Driver	
					HE	CQ
LD16	3.0" x 12.0" x 1.5"	90 - 305V	24V / 16W	-35-70C	0	0
LD25	3.0" x 12.0" x 1.5"	90 - 305V	24V / 25W	-35-70C	0	0
LD40	3.0" x 12.0" x 1.5"	90 - 305V	24V / 40W	-40-70C	1	1
LD60	3.0" x 12.0" x 1.5"	90 - 305V	24V / 60W	-40-70C	2	1
LD90	3.0" x 12.0" x 1.5"	90 - 305V	24V / 90W	-40-70C	3	2
LD100P	2.6" x 14.0" x 1.6"	90 - 305V	24V / 100W	-40-60C	3	2

DIMENSIONAL DATA

GRID MOUNT

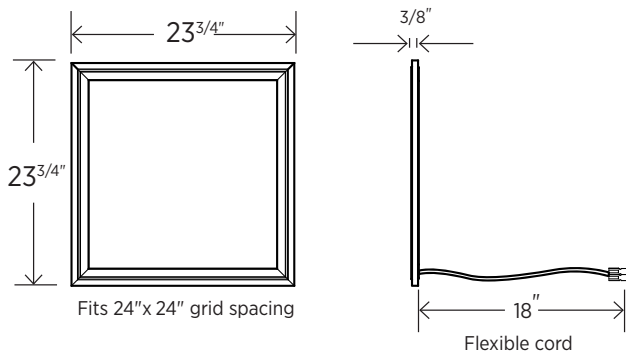

If specified for 9/16" grid application, please note it on specification.

FLUSH MOUNT

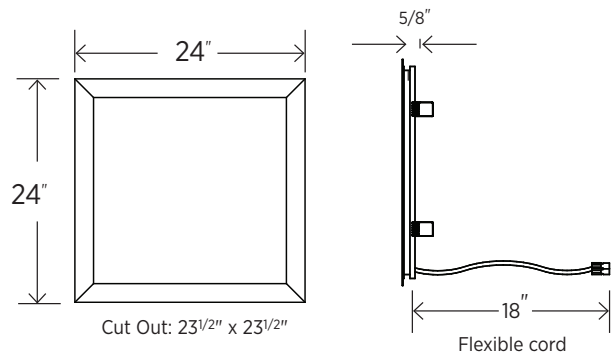

Flush Mount must be installed on a hard ceiling.

Product Weight: 8.8 lbs

PHOTOMETRIC DATA

