

TAIDEN®

New Generation Digital Infrared Language Distribution System

Excellent conferencing solutions



Installation and Operating Manual

V 2.5

Remark:

- All rights reserved for translation, reprint or reproduction
 - Contents may change without prior announcement
 - All technical specifications are guideline data and no guaranteed features
 - We are not responsible for any damage caused by improper use of this manual
 - The equipment must be connected to earth!
 - This product conforms to the rules of the European directive 2014/30/EU.
 - To protect your hearing avoid high pressure level on earphones. Adjust to a lower and convenient level.
 - If any detailed information needed, please contact your local agent or **TAIDEN** service center in your region.
- Any feedback, advice and suggestion about the products is appreciated
- **TAIDEN** is the registered trademark of TAIDEN Co., Ltd.

Important Safety Instructions

1. Read these instructions.
2. Keep these instructions.
3. Heed all warnings.
4. Follow all instructions.
5. The apparatus shall not be exposed to dripping or splashing and that no objects filled with liquids, such as vases, shall be placed on the apparatus.
6. The MAINS plug serving as a disconnection device, should be easy to operate.
7. The apparatus should be connected to the MAINS socket-outlet with protective earth.
8. Clean only with dry cloth.
9. Do not block any ventilation openings. Install in accordance with the manufacturer's instructions.
10. Do not install near any heat sources such as radiators, heat registers, stoves, or other apparatus (including amplifiers) that produce heat.
11. Do not defeat the safety purpose of the polarized or grounding-type plug. A polarized plug has two blades with one wider than the other. A grounding type plug has two blades and a third grounding prong. The wide blade and the third prong are provided for your safety. If the provided plug does not fit into your outlet, consult an electrician for replacement of the obsolete outlet.
12. Protect the power cord from being walked on or pinched particularly at plugs, convenience receptacles, and the point where they exit from the apparatus.
13. Only use attachments/accessories specified by the manufacturer.
14. Use only with the cart, stand, tripod, bracket, or table specified by the manufacturer, or sold with the apparatus. When a cart is used, use caution when moving the cart/apparatus combination to avoid injury from tip-over.
15. Do not leave the battery near the fire or under an environment over 60 °C (such as under direct sunlight in the car), otherwise it may damage the protection circuit of the battery and cause fire, explosion, leakage or heat generation.
16. Unplug this apparatus during lightning storms or when unused for long periods of time.
17. Refer all servicing to qualified service personnel. Servicing is required when the apparatus has been damaged in any way, such as power-supply cord or plug is damaged, liquid has been spilled or objects have fallen into the apparatus, the apparatus has been exposed to rain or moisture, does not operate normally, or has been dropped.
18. Do not place the equipment on any uneven or unstable stand; original product package or appropriate package should be used to avoid damage caused by strong impacts during transportation.
19. Power supply cords:
AC 100 V-240 V 60 Hz or 50 Hz
20. The quantity of connected transceivers in one system should not exceed prescribed quantity. For service, please contact the nearest TAIDEN Service Center.
21. All TAIDEN products are guaranteed for definite time (see the WARRANTY CARD for details) excluding the following cases:
 - A. All damage or malfunction caused by human negligence;
 - B. Damage or malfunction caused by improper operating by operator;
 - C. Parts damage or loss caused by disassembling the product by non-authorized personnel.
22. Use ONLY specified connection cable to connect the system equipment.
23. Upon receipt of the product, please fill out the Warranty Card enclosed and post it to TAIDEN Service Center nearby in your region.
24. It will result in low battery and may damage the battery pack if the battery pack is not used for a long time. Please fully charge the battery every three months.



TO REDUCE THE RISK OF ELECTRIC SHOCK, DO NOT EXPOSE THIS EQUIPMENT TO RAIN OR MOISTURE.

CAUTION: To reduce the risk of electric shock, DO NOT open covers, no useable serviceable parts inside. Refer servicing to qualified service personnel only.

CAUTION: DO NOT use alcohol, ammonia or petroleum solvents or abrasive cleaners to clean the devices.

Important Safety Instructions



The lightning flash with an arrowhead symbol, with an equilateral triangle, is intended to alert the user to the presence of uninsulated 'dangerous voltage' within the products enclosure that may be of sufficient magnitude to constitute a risk of electric shock to persons.



The exclamation mark within an equilateral triangle is intended to alert the user to the presence of important operating and maintenance (servicing) instructions in the literature accompanying the appliance.

WARNING: To reduce the risk of fire or electric shock, DO NOT expose units to rain or moisture.



Attention: Installation should be performed by qualified service personnel only in accordance with the National Electrical or applicable local codes.



Power Disconnect: Units with or without ON – OFF switch have power supplied to the unit whenever the power cord is inserted into the power source; however, the unit is operational only when the ON – OFF switch is in the ON position. The power cord is the main power disconnect for all units

WARNING: The apparatus should be connected to a mains socket outlet with a protective earthing connection.

Lithium battery safety precautions

- To change battery please power off and take off the battery immediately.
- Keep the battery away from heat sources to prevent fire or explosion.
- Do not use a battery that is leaking, deformed, discolored or overheats.
- Take extra precautions to keep a leaking battery from fire.
- Do not use a battery that emits odor or smoke.
- Do not solder, disassemble, puncture or deform the battery, otherwise, it may damage the protection circuit of the battery and cause fire, leakage or explosion.
- Do not short-circuit the positive and negative electrode with wire or other metal objects, otherwise it may cause fire, explosion, leakage or heat generation.
- Do not store or transport the battery with metal objects (such as necklace or hair grip), otherwise it may cause fire, explosion, leakage or heat generation.
- Do not heat the battery or throw it into fire, otherwise it may damage the safety valve or the protection circuit of the battery and may cause fire or explosion.
- Do not put the battery in the water or moisten the electrode of the battery, otherwise it may corrode the battery and cause fire, explosion, leakage or heat generation.
- Be careful to put the battery into the charging case with correct electrode position, otherwise it may cause fire, explosion, leakage or heat generation.
- Do not leave the battery near the fire or under an environment over 60 °C (such as in the car from direct sunlight), otherwise it may damage the protection circuit of the battery and cause fire, explosion, leakage or heat generation.
- Please charge the battery with the dedicated base plate, using other charging unit may cause fire, explosion, leakage or heat generation.
- Please use the battery in assigned unit, otherwise it may cause fire, explosion, leakage or heat generation.
- Do not drop or shock the battery, otherwise it may damage the protection circuit of the battery and cause fire, explosion, leakage or heat generation.
- If battery contents get into eyes it may cause blurred vision. DO NOT rub. Rinse with clear water immediately and consult a doctor.
- If the battery leaks onto skin or clothing, wash the area immediately with clean water to avoid skin injury and fabric damage.
- It will result in low battery and may damage the battery if the battery is not used for a long time. Please take off the battery, and fully charge the battery for every three months.

Contents

Chapter 1. Introduction	1
1.1 Summary	1
1.2 System technology	4
1.2.1 Basic system concept	4
1.2.2 IR radiation	4
1.2.3 Signal processing	4
1.2.4 Audio quality modes	5
1.2.5 Carriers and channels	5
1.3 Aspects of infrared distribution	6
1.3.1 Ambient lighting	6
1.3.2 Objects, surfaces and reflections	6
1.3.3 Directional sensitivity of the receiver	6
1.3.4 The footprint of the radiator	6
1.3.5 Positioning the radiators	7
1.3.6 Overlapped footprints and multipath effects	8
Chapter 2. HCS-5100M/F Series Digital Infrared Transmitter.....	9
2.1 Overview	9
2.2 Functions and indications	10
2.3 Installation	12
2.4 Connection	13
2.4.1 To another transmitter	13
2.4.2 To external audio sources	13
2.4.3 To emergency signal switch	13
2.4.4 To interpreter unit	14
2.4.5 To HCS-8300 Paperless Multi-media Congress System	14
2.5 Menu structure	16
2.5.1 Transmitter menu structure (work mode: Master-Analog)	16
2.5.2 Transmitter menu structure (work mode: Master- Interp. U)	17
2.5.3 Transmitter menu structure (work mode: Master- Central U)	18
2.5.4 Transmitter menu structure (work mode: Master-Dante)	19
2.5.5 Transmitter menu structure (work mode: Bypass)	20
2.6 Configuration and operation	21
2.6.1 Work Mode	22
2.6.2 Carrier(s) Setting	23
2.6.3 Channel Name Setting	23
2.6.4 Audio Input Sensitivity	24
2.6.5 Auxiliary Input Setting	24
2.6.6 Front Panel Radiator Setting	24
2.6.7 Alarm Setting	25
2.6.8 Operation Language Setting	25
2.6.9 Network Setting	25
2.6.10 Use Testing Audio Signal	25
2.6.11 Parameters Backup/Restore	25
2.6.12 Machine Rename	26
2.6.13 About	26

2.6.14 Simultaneous Interpretation	26
2.6.15 Floor Input Sen. Setting	28
2.6.16 IR Audio In Gain Setting	28
2.6.17 SI Channel Parameters Setting	28
2.6.18 Floor Distribution Setting.....	29
2.6.19 Time Setting.....	29
2.6.20 Time Display Setting	29
2.6.21 Interpreter Unit Numbering	29
2.6.22 Fiber Port Setting	29
2.6.23 Number of Channel(s) Setting	29
2.6.24 Channel Gain Setting.....	30
2.6.25 About Dante	30
2.7 Monitor	30
Chapter 3. HCS-5100M/A and HCS-5100M/B Series.....	31
Digital Infrared Transmitter	31
3.1 Overview	31
3.2 Functions and indications	32
3.2.1 HCS-5100M/A series	32
3.2.2 HCS-5100M/B series	34
3.3 Installation	36
3.4 Connection	37
3.4.1 To another transmitter.....	37
3.4.2 To external audio sources.....	37
3.4.3 To emergency signal switch.....	37
3.4.4 Connect to interpreter unit	38
3.4.5 To HCS-4100/50, HCS-4800, HCS-8300, HCS-8600 Congress System.....	39
3.5 Menu structure	43
3.5.1 Transmitter menu structure (work mode: Master-Analog)	43
3.5.2 Transmitter menu structure (work mode: Master- Interp. U).....	43
3.5.3 Transmitter menu structure (work mode: Master- Central U)	43
3.5.4 Transmitter menu structure (work mode: Master-Dante).....	43
3.5.5 Transmitter menu structure (work mode: Bypass)	43
3.6 Configuration and operation	44
3.6.1 Work Mode Setting.....	45
3.6.2 Carrier(s) Setting.....	46
3.6.3 Channel Name	46
3.6.4 Audio Input Sen.....	46
3.6.5 Auxiliary Input Setting	47
3.6.6 Front Panel Radiator	47
3.6.7 Monitor Setting	48
3.6.8 Alarm Setting.....	48
3.6.9 Operation Language	48
3.6.10 Network Setting.....	48
3.6.11 Use Testing Audio.....	49
3.6.12 Backup/Restore.....	49
3.6.13 Machine Rename	49
3.6.14 Screensaver	49

3.6.15 About.....	49
3.6.16 SI Status.....	50
3.6.17 Simultaneous Interp.	50
3.6.18 Floor Input Sensitivity.....	52
3.6.19 SI Ch. Parameters.....	52
3.6.20 Floor Distribution.....	52
3.6.21 Sampling Rate Setting.....	53
3.6.22 Time Setting.....	53
3.6.23 Time Display Setting.....	53
3.6.24 Unit Numbering.....	53
3.6.25 Fiber Port Setting.....	53
3.6.26 Number of Channel.....	53
3.6.27 Channel Gain Setting.....	53
3.6.28 About Dante.....	54
Chapter 4. Digital Infrared Radiator.....	55
4.1 Overview.....	55
4.2 Functions and indications.....	56
4.3 Position scheme.....	57
4.3.1 Rectangular footprints.....	57
4.3.2 Planning radiators.....	57
4.3.3 Cabling.....	58
4.4 Mounting.....	59
4.4.1 Mounting on a floor stand.....	59
4.4.2 Wall mounting.....	59
4.4.3 Ceiling mounting.....	60
4.4.4 Mounting on horizontal surface.....	60
4.5 Connecting to transmitter.....	61
4.6 Output power selection.....	61
4.7 Setting the radiator delay switches.....	62
4.7.1 System with one transmitter.....	62
4.7.2 System with two or more transmitters in one room.....	63
4.7.3 System with more than 4 carriers and a radiator under a balcony.....	65
4.7.4 System that mixes TAIDEN radiator with other brands compatible radiator.....	65
Chapter 5. Digital Infrared Receiver.....	66
5.1 Overview.....	66
5.2 Functions and indications.....	67
5.3 Operation.....	68
5.4 Testing the coverage area.....	69
5.5 Earphones.....	70
5.6 Li-ion Rechargeable Battery Pack.....	70
Chapter 6. Web server.....	71
6.1 Login and exit.....	71
6.2 Conference management.....	72
6.2.1 Normal.....	73
6.2.2 Carrier Setting.....	74
6.2.3 Sensitivity.....	75

6.2.4 S.I. Setup	75
Chapter 7. Charging Case and Storage case.....	77
7.1 Charging case	77
7.1.1 Overview	77
7.1.2 Charging procedure	77
7.2 Storage case	78
Chapter 8. Fault diagnosis	79
Chapter 9. Technical data.....	80
9.1 System specification.....	80
9.2 Infrared transmitters	81
9.3 Radiators and accessories	82
9.4 Receiver	83
9.5 Accessory.....	84
9.5.1 Earphones.....	84
9.5.2 Li-ion Rechargeable Battery Pack (HCS-5100BAT-Li)	85
9.5.3 Charging Case (HCS-5100CHG/60).....	85
9.5.4 Storage Case (HCS-5100KS)	85
9.5.5 HCS-4853T Cable Splitter	85
9.6 Connection details.....	86
9.6.1 Mains cables	86
9.6.2 Audio cables.....	86
9.6.3 Earphones.....	86
9.6.4 Emergency switch	86
9.7 Guaranteed rectangular footprints	87
9.8 Display language list	88

Installation & User Guide

About this manual

This manual is a comprehensive guide to the installation and operation of TAIDEN HCS-5100Plus New Generation Digital Infrared Language Distribution System. It includes the detailed description of the functions and interfaces of the HCS-5100Plus system components, system connection and installation, system set-up and operation.

The manual is divided into the following chapters:

Chapter 1: Introduction

Introduction to the HCS-5100Plus system, as well as introducing the user into constitution, technical principle and aspects of infrared distribution systems.

Chapter 2: HCS-5100M/F Series Digital Infrared Transmitter

Detailed description of functions, connection, configuration, operation and monitor function.

Chapter 3: HCS-5100M/A Series Digital Infrared Transmitter

Detailed description of functions, connection, configuration, operation and monitor function.

Chapter 4: Digital Infrared Radiator

Detailed description of functions, connection, position planning, installation of the radiator, and using of power switch and delay switch.

Chapter 5: Digital Infrared Receiver

Detailed description of functions, operation, using of testing mode and introduction to earphone and battery.

Chapter 6: Web server

Detailed description of functions and corresponding operation to the Web server of HCS-5100/F main unit.

Chapter 7: Charging Case and Storage Case

Detailed description of functions, charging operation, precautions and introduction to the Storage Case of HCS-5100KS.

Chapter 8: Fault diagnosis

Trouble-shooting guide for simple faults.

Chapter 9: Technical data

Mechanical and electrical details of the complete HCS-5100 equipment.

Installation & User Guide

This manual is applicable to:

■ Digital Infrared Transmitter

HCS-5100MA/FS/04F/08F/16F

4, 8, 16 CHs Digital Infrared Transmitter (compatible with interpreter unit or HCS-4100M/HCS-8300M, single-mode optical fiber interface)

HCS-5100MA/04F/08F/16F

4, 8, 16 CHs Digital Infrared Transmitter (compatible with interpreter unit or HCS-4100M/HCS-8300M)

HCS-5100MC/04FD/08FD/16FD

4, 8, 16 CHs Digital Infrared Transmitter (with Dante interface)

HCS-5100MC/04F/08F/16F/32F/40F

4, 8, 16, 32, 40 CHs Digital Infrared Transmitter

HCS-5100MA/FS/04A/08A/16A

4, 8, 16 CHs Digital Infrared Transmitter (compatible with interpreter unit or HCS-4100M/HCS-8300M, single-mode optical fiber interface)

HCS-5100MA/04A/08A/16A

4, 8, 16 CHs Digital Infrared Transmitter (compatible with interpreter unit or HCS-4100M/HCS-8300M)

HCS-5100MC/04AD/08AD/16AD/40AD

4, 8, 16, 40 CHs Digital Infrared Transmitter (with Dante interface)

HCS-5100MC/04A/08A/16A/32A/40A

4, 8, 16, 32, 40 CHs Digital Infrared Transmitter

■ Digital Infrared Radiator

HCS-5100T/15B

15W Digital Infrared Radiator r (delay compensation function, 75 Ω, switching mode power supply, without fan)

HCS-5100T/25B

25W Digital Infrared Radiator r (delay compensation function, 75 Ω, switching mode power supply, without fan)

HCS-5100T/35B

35W Digital Infrared Radiator r (delay compensation function, 75 Ω, switching mode power supply, without fan)

■ Digital Infrared Receiver

HCS-5100R/04F/08F/16F/32F/40F

4, 8, 16, 32, 40 CHs Digital Infrared Receiver (LCD, language display, optional rechargeable battery pack or 2xAA alkaline cells)

HCS-5100RA/04F/08F

4, 8 CHs Digital Infrared Receiver (LCD, language display, 2xAA alkaline cells)

■ Earphone

EP-820AS

Single Earphone (TRS connector, Ring: NC)

EP-829

Single Earphone (TRS connector, Ring: NC)

EP-830

Single Earphone (TRS connector, Ring: NC)

HCS-5100PA

Headphone

EP-960BH

Headphone

■ Li-ion Rechargeable Battery Pack

HCS-5100BAT-Li

Li-ion Rechargeable Battery Pack (for HCS-5100R/F series Digital Infrared Receiver)

■ IR Receiver Charging Case

HCS-5100CHG/60

IR Receiver Charging Case (60 pcs/case)

HCS-5100CHG/60A

IR Receiver Charging Case (60 pcs/case)

■ IR Receiver Storage Case

HCS-5100KS

IR Receiver Storage Case (100 pcs/case)

Chapter 1. Introduction

1.1 Summary

HCS-5100Plus series is the new generation system for digital infrared language distribution. It uses digital infrared audio transmitting and control technique dirATC as well as a special digital infrared chip, both TAIDEN's intellectual property. HCS-5100Plus can be used in simultaneous interpretation systems for multi-language conferences.

In simultaneous interpretation systems, the interpreter translates the speaker's speech and the translated audio is transmitted within the conference venue by modulated infrared radiation. Delegates may now select a language on the infrared receiver and listen via earphone.

The system can also be used for other audio signal

distribution occasions, such as music distribution (mono as well as stereo).

The HCS-5100Plus series is compliant to IEC 61603-7 (Transmission of audio and/or video and related signals using infra-red radiation-Part 7: Transmission system for digital audio signals for conference and similar applications) and IEC 60914 (Conference systems - Electrical and audio requirements), moreover, it is compatible with other IR systems, compliant to IEC 61603-7.

Parts of IEC 61603 are used in this manual for a better understanding of both theory and technique of the system.

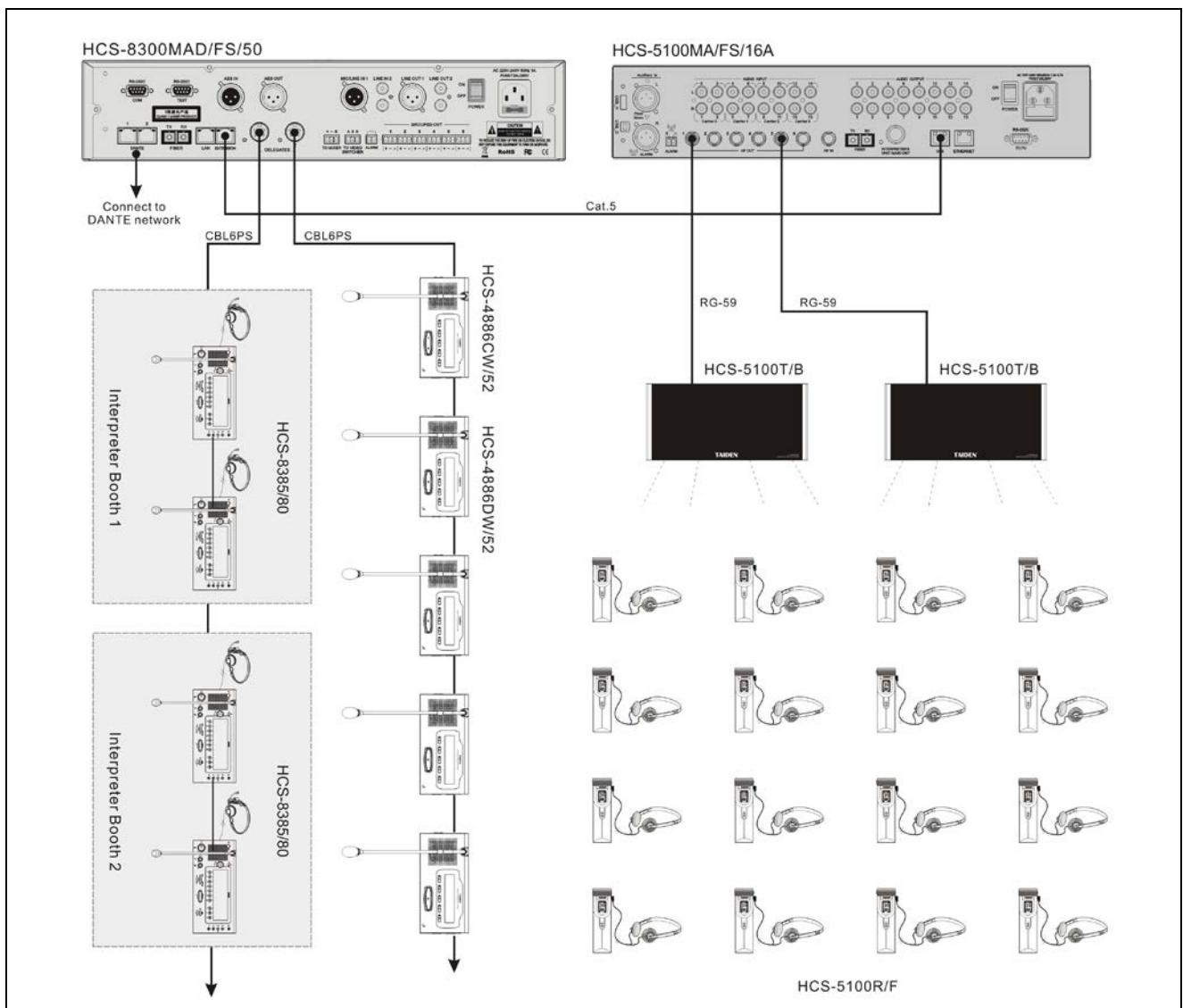

Figure 1.1 System overview

The system is composed of one or more of the following:

■ **Digital Infrared Transmitter**

HCS-5100MA/FS/04F/08F/16F

4, 8, 16 CHs Digital Infrared Transmitter (compatible with interpreter unit or HCS-4100M/HCS-8300M, single-mode optical fiber interface)

HCS-5100MA/04F/08F/16F

4, 8, 16 CHs Digital Infrared Transmitter (compatible with interpreter unit or HCS-4100M/HCS-8300M)

HCS-5100MC/04FD/08FD/16FD

4, 8, 16 CHs Digital Infrared Transmitter (with Dante interface)

HCS-5100MC/04F/08F/16F/32F/40F

4, 8, 16, 32, 40 CHs Digital Infrared Transmitter

HCS-5100MA/FS/04A/08A/16A

4, 8, 16 CHs Digital Infrared Transmitter (compatible with interpreter unit or HCS-4100M/HCS-8300M, single-mode optical fiber interface)

HCS-5100MA/04A/08A/16A

4, 8, 16 CHs Digital Infrared Transmitter (compatible with interpreter unit or HCS-4100M/HCS-8300M)

HCS-5100MC/04AD/08AD/16/40AD

4, 8, 16, 40 CHs Digital Infrared Transmitter (with Dante interface)

HCS-5100MC/04A/08A/16A/32A/40A

4, 8, 16, 32, 40 CHs Digital Infrared Transmitter

HCS-5100MA/FS/08/16B

8, 16 CHs Digital Infrared Transmitter ((compatible with HCS-4100M/HCS-8300M/HCS-4800M/HCS-8600M or HCS-4385U/50 interpreter unit,HCS-8685 interpreter unit can be connected via HCS-4853T cable splitter,single-mode optical fiber interface)

HCS-5100MA/04/08B

4, 8 CHs Digital Infrared Transmitter (compatible with HCS-4100M/HCS-8300M/HCS-4800M/HCS-8600M or HCS-4385U/50 interpreter unit,,HCS-8685 interpreter unit can be connected via HCS-4853T cable splitter)

HCS-5100MC/08/16/40BD

8, 16, 40 CHs Digital Infrared Transmitter (Dante interface)

HCS-5100MC/40B

40Hs Digital Infrared Transmitter

■ **Digital Infrared Radiator**

HCS-5100T/15B

15W Digital Infrared Radiator (delay compensation function, 75 Ω, switching mode power supply, without fan)

HCS-5100T/25B

25W Digital Infrared Radiator (delay compensation function, 75 Ω, switching mode power supply, without fan)

HCS-5100T/35B

35W Digital Infrared Radiator (delay compensation function, 75 Ω, switching mode power supply, without fan)

■ **Digital Infrared Receiver**

HCS-5100R/04F/08F/16F/32F/40F

4, 8, 16, 32, 40 CHs Digital Infrared Receiver (LCD, language display, optional rechargeable battery pack or 2xAA alkaline cells)

HCS-5100RA/04F/08F

4, 8 CHs Digital Infrared Receiver (LCD, language display, 2xAA alkaline cells)

■ **Cable Splitter**

HCS-4853T

6-pin to 8-pin Cable Splitter (1 input (6P-DIN) & 3 outputs (8P-DIN), For the connection of HCS-5100M/B series Digital Infrared Transmitter and HCS-4800 series Conference Unit / HCS-8685 Interpretation Unit)

■ **Earphone**

EP-820AS

Single Earphone (TRS connector, Ring: NC)

EP-829

Single Earphone (TRS connector, Ring: NC)

EP-830

Single Earphone (TRS connector, Ring: NC)

HCS-5100PA

Headphone

EP-960BH

Headphone

■ **Li-ion Rechargeable Battery Pack**

HCS-5100BAT-Li

Li-ion Rechargeable Battery Pack (for HCS-5100R/F series Digital Infrared Receiver)

■ **IR Receiver Charging Case**

HCS-5100CHG/60

IR Receiver Charging Case (60 pcs/case)

HCS-5100CHG/60A

IR Receiver Charging Case (60 pcs/case)

■ **IR Receiver Storage Case**

HCS-5100KS

IR Receiver Storage Case (100 pcs/case)

1.2 System technology

1.2.1 Basic system concept

The basic system concept is shown in figure 1.2.

The system consists of a number (N) of audio sources, either analog or digital, which are connected to a transmitter. The transmitter processes the audio signals into an electrical output to feed the infrared radiator (see section 1.2.3). The infrared signal is received by the infrared receiver that processes the signal and outputs an audio signal and/or associated data.

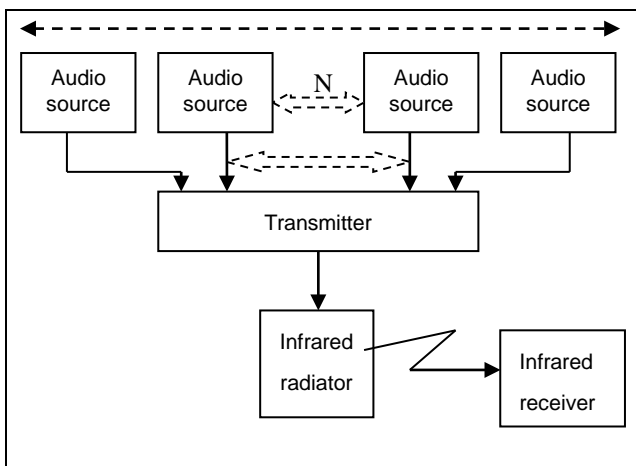

Figure 1.2 The basic system concept

1.2.2 IR radiation

HCS-5100Plus series audio signal is based on transmission by modulated infrared radiation (IR). Infrared radiation is part of the electro-magnetic spectrum, which is composed of visible light, radio waves and other types of radiation. The IR wavelength is larger than the wavelength of visible light.

Conference hall privacy: the congress venue itself acts as a barrier to infrared signals escaping. As Infrared is unable to pass through opaque objects such as walls, the signal cannot be overheard. Moreover, HCS-5100Plus series does not emit radio radiation. Operating the system does not require a radio frequency license, worldwide.

1.2.3 Signal processing

HCS-5100Plus uses high frequency carrier signals (typically 1-8 MHz) to prevent interference by modern light sources. Fully digital audio processing guarantees a constant high audio quality.

The signal processing in the transmitter consists of the following main steps (see figure 1.3):

1. Code – each analog audio channel is converted to a digital signal; the digital signals are compressed to increase the amount of information that can be distributed on each carrier (compression ratio is related to required audio quality); groups of up to 4 digital signals are combined into a digital information stream. Extra fault algorithm information is added. This information is used by the receivers for fault detection and correction.
2. Modulation – a high frequency carrier signal is phase-modulated with the digital information stream by DQPSK digital modulation technique.
3. Filter.
4. Magnify.
5. Radiation – up to 10 modulated carrier signals are combined and sent to the IR radiators, which convert the carrier signals to modulated infrared light.

In the IR receivers, a reverse processing is used to convert the modulated infrared light to separate digital audio channels.

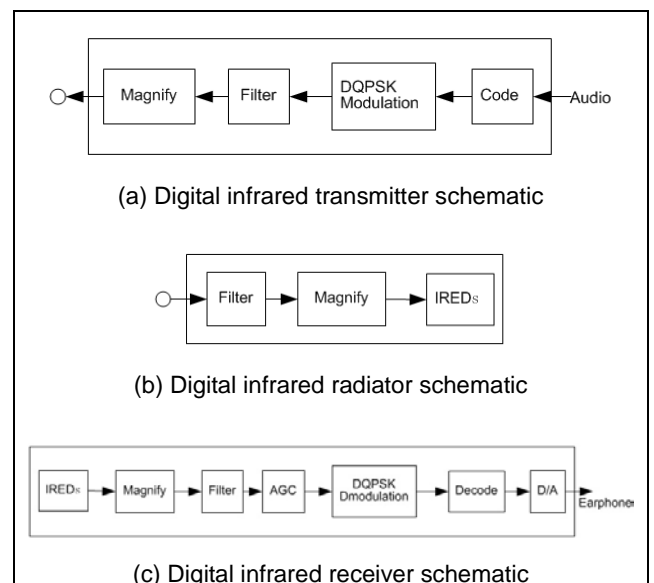

Figure 1.3 Overview of the signal processing

1.2.4 Audio quality modes

HCS-5100Plus can transmit audio in four different quality modes:

- Mono, standard quality, maximum 40 channels
- Mono, perfect quality, maximum 20 channels
- Stereo, standard quality, maximum 20 channels
- Stereo, perfect quality, maximum 10 channels

The standard quality mode uses less bandwidth and is used for transmitting speech. The perfect quality mode gives near CD quality and is used for transmitting music.

1.2.5 Carriers and channels

HCS-5100Plus is transmitting within the 1 ~ 8 MHz frequency band. It can transmit up to 10 different carrier signals (depending on the transmitter type). Carriers 0 to 5 are according to IEC 61603-7 (see figure 1.4). Figure 1.5 shows the band allocation.

Each carrier can carry up to 4 audio channels. The exact number of channels per carrier depends on the selected quality modes. Stereo signals use twice as much bandwidth as mono signals; perfect quality uses twice as much bandwidth as standard quality.

A mix of channels with different quality modes can be chosen for each carrier, with the total bandwidth not exceeding the available bandwidth. The table below lists all possible channel combinations per carrier:

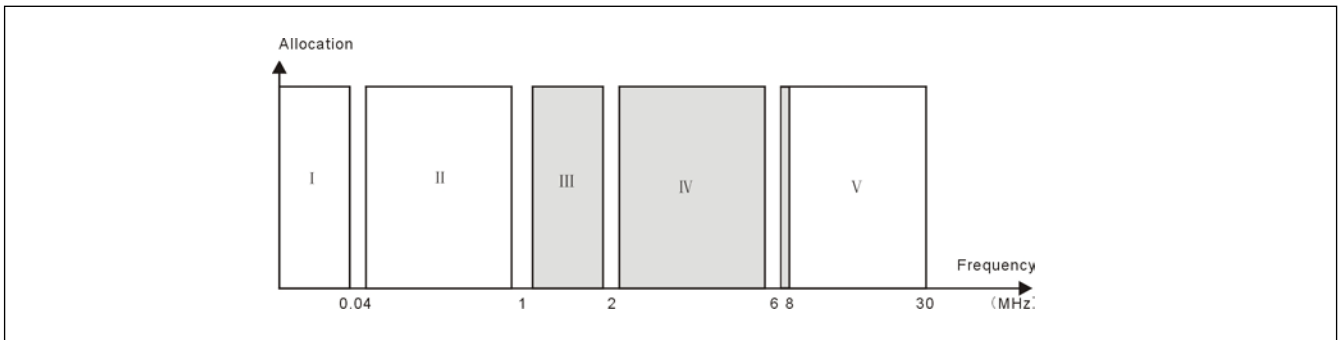

Figure 1.4 Standard band of HCS-5100Plus infrared language distribution system

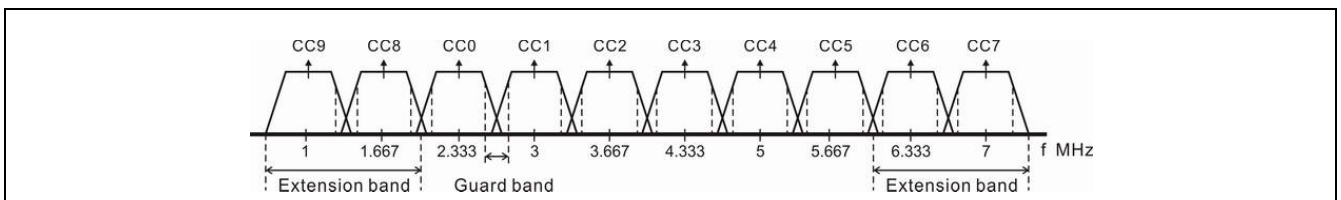

Figure 1.5 Band allocation

Table 1.1 The numbers and quality modes of channels per carrier

Possible number of channels per carrier	Channel quality				Bandwidth
	Standard Mono	Perfect Mono	Standard Stereo	Perfect Stereo	
4					4 x 10 kHz
2		1			2 x 10 kHz and 1 x 20 kHz
2			1		2 x 10 kHz and 1 x 10 kHz (left) and 1 x 10 kHz (right)
		1	1		1 x 20 kHz and 1 x 10 kHz (left) and 1 x 10 kHz (right)
			2		2 x 10 kHz (left) and 2 x 10 kHz (right)
		2			2 x 20 kHz
				1	1 x 20 kHz (left) and 1 x 20 kHz (right)

1.3 Aspects of infrared distribution

A good digital infrared language distribution system ensures that all delegates in a conference venue receive the distributed signals without disturbance. This is achieved by using a sufficient number of well positioned radiators, in such a way that uniform IR signal with adequate strength can be received at any place of the conference venue.

When planning an infrared distribution system several aspects influencing the uniformity and quality of the infrared signal should be considered. These are described in the next sections.

1.3.1 Ambient lighting

HCS-5100Plus can be operated without any problem even if fluorescent lamps (with or without electronic ballast or dimming facility), such as TL lamps or energy saving lamps are switched on. (see figure 1.6).

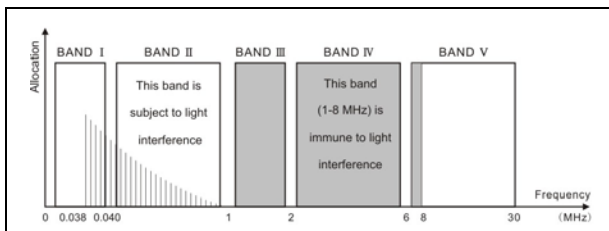

Figure 1.6 The infrared language distribution system using 1-8 MHz eliminates disturbance from high frequency lighting systems

If the venue has large windows, which are not covered by curtains or shade cloth, more radiators should be added. For outdoor use, a site test will be required to determine the required amount of radiators. With sufficient radiators, the receivers will work well, even in bright sunlight.

1.3.2 Objects, surfaces and reflections

Just like visible light, infrared radiation is reflected from hard surfaces and refracted by hyaloid (glassy or transparent appearance) objects. Both objects in the conference venue and structure of the walls and ceilings will influence the distribution of infrared light. Infrared radiation is reflected from almost all hard surfaces. Smooth, bright or shiny surfaces reflect well. Dark or rough surfaces absorb a large part of the infrared energy. Normally surfaces opaque to visible

light are also opaque to infrared radiation. Shadows from walls and furniture will influence the transmission of infrared light. This can be solved by using a sufficient quantity of radiators. They should be positioned in a manner to provide an infrared field strong enough to cover the whole conference area.

Note:
Please do not put the radiator towards directly to a window without curtains or shade cloth, otherwise the radiant energy will be greatly lost.

1.3.3 Directional sensitivity of the receiver

The sensitivity of a receiver is at its best when it aims directly towards a radiator. To minimize the disadvantage of this aspect, HCS-5100R/RA/F receiver adopts an ingenious structural design with peculiar 270° ultra wide angle to get perfect IR capture and sound quality at any disposition (see figure 1.7).

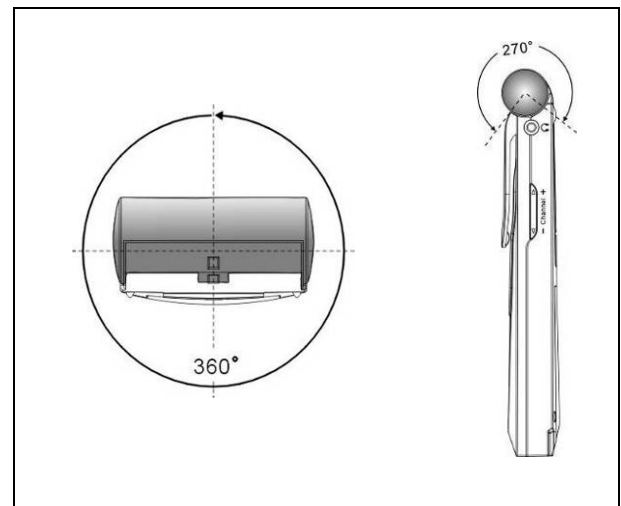

Figure 1.7 Directional characteristics of the receivers

1.3.4 The footprint of the radiator

The number of transmitted carriers and the output power of the radiator determine the coverage area of a radiator. The total radiation energy of a radiator is distributed over transmitted carriers. The coverage area becomes proportionally smaller if more carriers are used. The receiver requires a strength of the IR signal of 4 mW/m² per carrier to work well (resulting in

an 80 dB S/N ratio for uninterrupted audio channels). The cross section of the 3-dimensional radiation with the reception level of participants is the footprint (the dark grey area in figure 1.8 to figure 1.10). In this area, the direct signal is strong enough to ensure proper reception when the receiver is directed towards the radiator. The size and position of the footprint depends on the mounting height and the angle of the radiator.

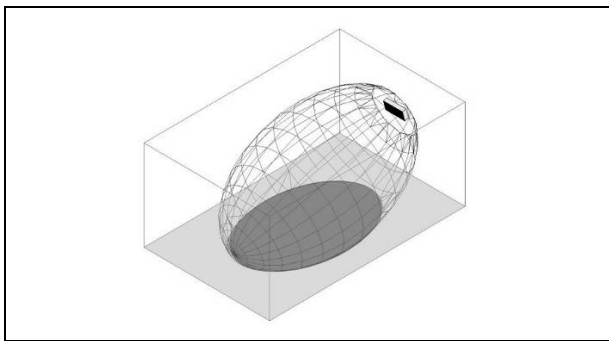

Figure 1.8 The radiator mounted at 15° to the ceiling

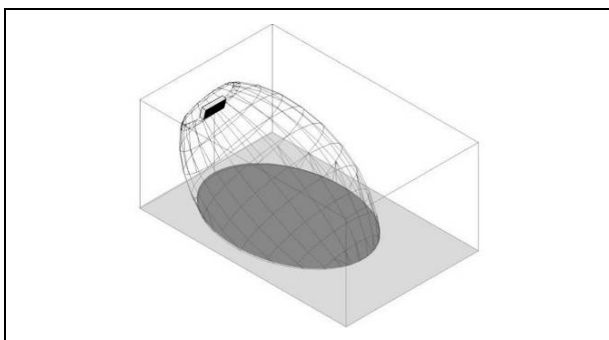

Figure 1.9 The radiator mounted at 30° to the ceiling

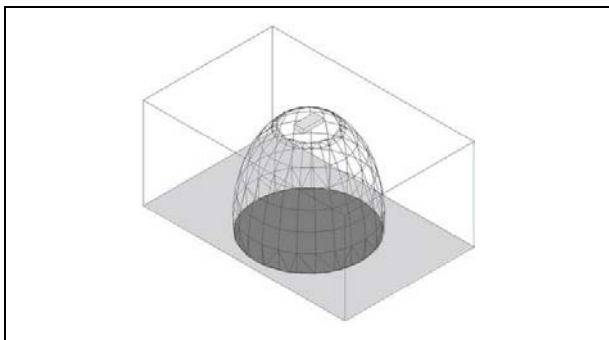

Figure 1.10 The radiator mounted perpendicular (at 90°) to the ceiling

1.3.5 Positioning the radiators

Because infrared radiation can reach a receiver directly and/or via diffused reflections, it's important to take this into consideration when installing the radiators. For best reception quality, receivers should pick up direct infrared radiation. In addition reflections will improve the signal reception. In big conference halls, infrared signal will be blocked by the people in front of the receiver. For that reason the radiator should be installed at an appropriate height, usually not below 2.5 meters.

If the layout is arranged around the center of the venue, install the radiators towards to the center can effectively cover the whole conference area; if the layout of the venue changes frequently, the angle of the receivers will change accordingly, you can consider installing the radiators on the corner.

In the case of the seating is always directed towards the IR emitting source, there are no radiators needed at the back (see figure 1.11).

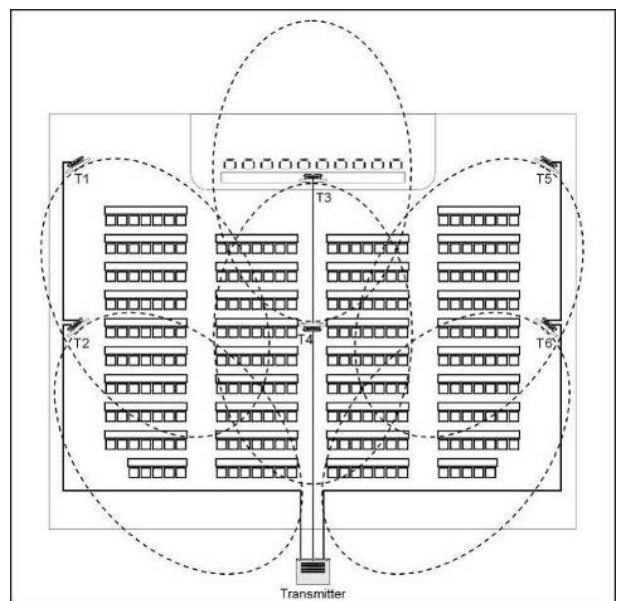

Figure 1.11 Radiator positioning in a conference hall with auditorium seating and podium

If the path of the infrared signals is blocked, e.g. under balconies, at least one additional radiator is needed to cover the blind area, where the infrared light is blocked by the obstacle (see figure 1.12).

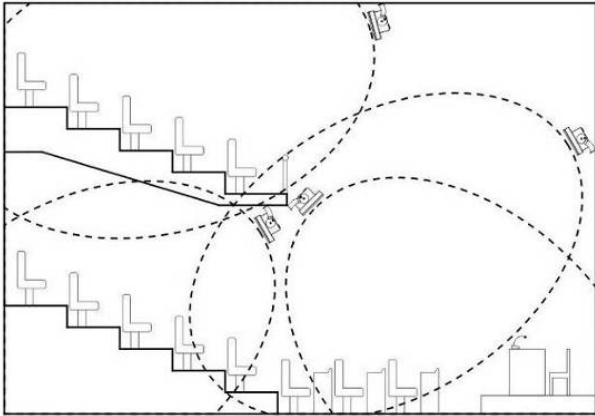

Figure 1.12 Radiator for covering seats beneath a balcony

1.3.6 Overlapped footprints and multipath effects

If footprints of two radiators overlap, the total coverage area maybe larger than the sum of the two separate footprints. In an area with overlap effect, the individual radiation signals of two radiators are added, resulting in an increase of the radiation intensity, larger than the required intensity.

However, due to the differences in the delays of the signals from two or more radiators, the signals may cancel out each other (multipath effect). In a worst-case situation, loss of reception at some positions (blind area) may be the consequence.

Figure 1.13 and figure 1.14 illustrate the effect of overlapped footprints and differences in signal delays.

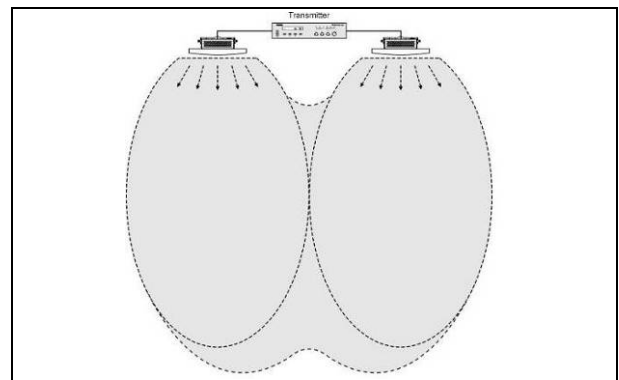

Figure 1.13 Increased coverage area caused by added radiation power

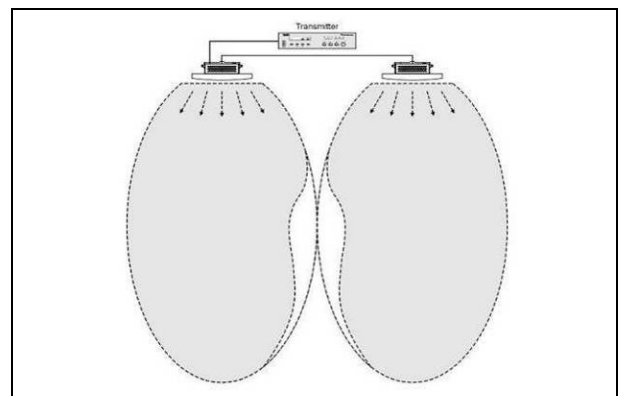

Figure 1.14 Reduced coverage area caused by differences in cable signal delay

The lower the carrier frequency, the less susceptible the receiver is for differences in signal delays.

The signal delays can be compensated by adjusting the delay compensation switches on the radiators (see section 3.7).

Chapter 2. HCS-5100M/F Series Digital Infrared Transmitter

2.1 Overview

The HCS-5100M/F transmitter is the heart of the HCS-5100Plus system. Up to 40 unbalanced audio signals can be accepted (under combination mode) via digital/analog audio signal input connectors. It can be connected to HCS-8300 or HCS-4100/50 congress main unit directly via optical fiber interface, 6P-DIN connector or DCS interface (RJ45 standard socket), and it can also be connected to other discussion and interpretation systems, or be used as a stand-alone system for distributing external audio signals. HCS-5100M/F is suitable for either tabletop or 19-inch rack mounting using. Four feet (for tabletop) and two brackets (for rack mounting) are supplied.

Types:

HCS-5100MA/FS/04F/08F/16F

4, 8, 16 CHs Digital Infrared Transmitter (compatible with interpreter unit or HCS-4100M/HCS-8300M, single-mode optical fiber interface)

HCS-5100MA/04F/08F/16F

4, 8, 16 CHs Digital Infrared Transmitter (compatible with interpreter unit or HCS-4100M/HCS-8300M)

HCS-5100MC/04FD/08FD/16FD

4, 8, 16 CHs Digital Infrared Transmitter (with Dante interface)

HCS-5100MC/04F/08F/16F/32F/40F

4, 8, 16, 32, 40 CHs Digital Infrared Transmitter

2.2 Functions and indications

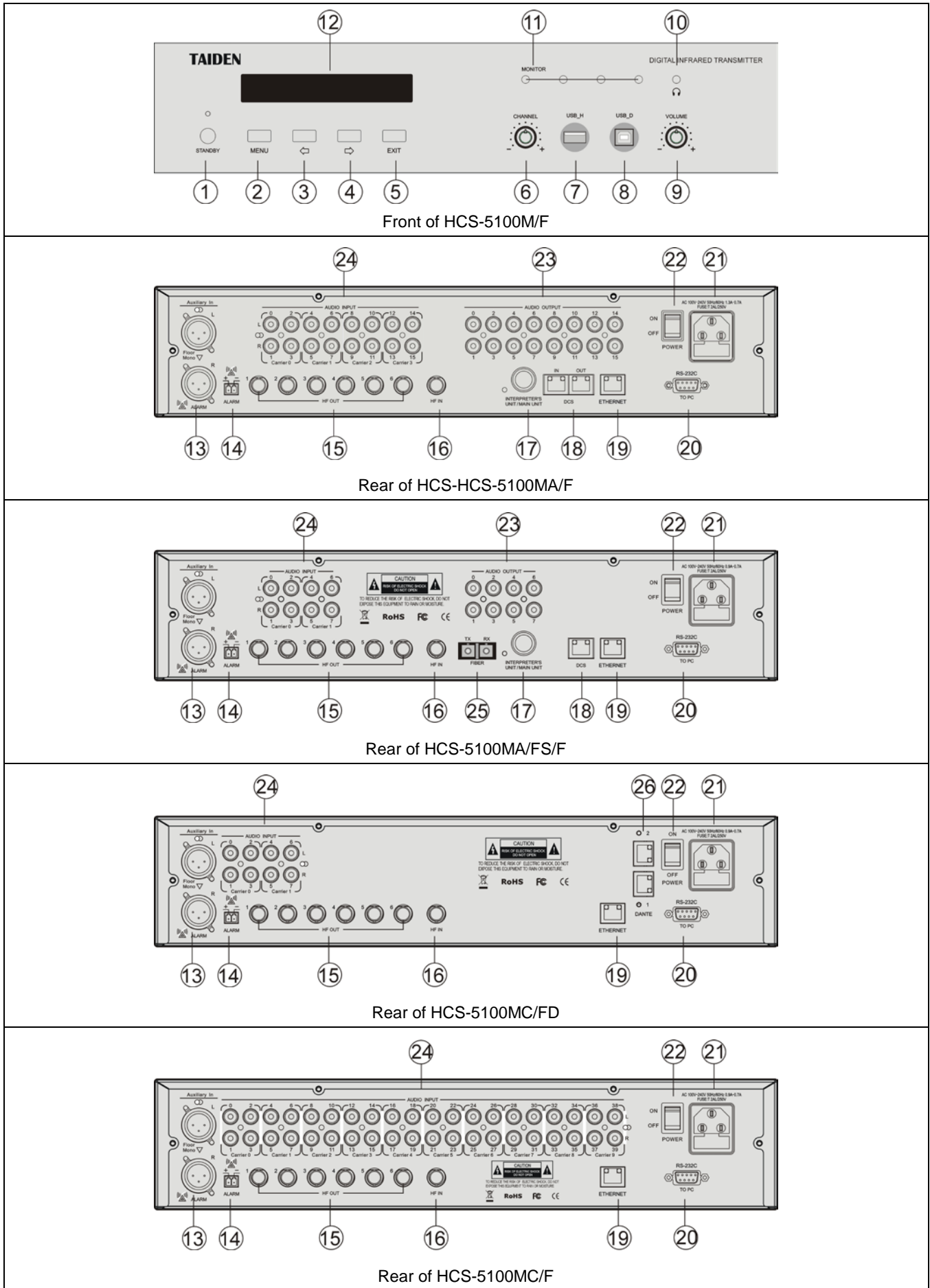

Figure 2.1 HCS-5100M/F Digital Infrared Transmitter

Figure 2.1:

1. Standby button with indicator

- When the switch is off, it does not completely disconnect the unit from mains

2. “MENU” button

- After starting initialization:, press the “MENU” button to go to main menu;
- Under main menu, press the “MENU” button to go to sub menu;
- Select/Deselect in network configuration

3. “←” (Left) button

4. “⇒” (Right) button

5. “EXIT” button

6. Monitor channel select knob

7. A type USB interface

- To plug-in a USB stick.

8. Mini USB interface (remain)

9. Monitor volume control knob

10. Monitor earphone interface

- Ø 3.5 mm jack for stereo monitor earphone

11. Mini IR radiator

- 4 IREds transmitting the same infrared signal as the radiator output for monitoring & testing purpose

12. Display

- 256x32 LCD. Display the status of the transmitter and the menu of system configuration

13. Auxiliary audio input

- Female XLR connectors for external audio inputs to connect auxiliary balanced audio signals such as music, floor language or emergency audio signal

14. Fire alarm linked trigger interface

- When this switch is closed, the emergency audio signal on the Aux-R input is distributed to all output channels and overriding all other audio inputs

15. HF signal output

- 6 BNC connectors for output HF signal to radiator. To each connector, up to 30 radiators can be connected

16. HF signal input

- 1 BNC connector for receiving HF signal from other transmitter

17. INTERPRETER’S UNIT / MAIN UNIT

- For connecting to interpreter unit
- For connecting to HCS-4100M/50 or HCS-8300M congress main unit via CBL6PP-02 extension cable

18. DCS interfaces

- For connecting to HCS-4100M/50 or HCS-8300M congress main units

19. Ethernet

- For communication between the conference main unit and the PC under TCP/IP protocol to realize Web server and remote controlling; furthermore, it enables remote controlling by wireless touch panel through central control system

20. RS-232

- For connecting to a central control system for central controlling, as well as for system diagnosis

21. Power supply

22. Power on/off

23. Audio signal output

- 4, 8, 16, 32 or 40 audio connectors. The number of connectors depends on the transmitter type

24. Audio signal input

- 4, 8, 16, 32 or 40 audio connectors to connect external unbalanced audio input signals. The number of connectors depends on the transmitter type

25. Single-mode fiber, SC connector

- For connecting to the congress main unit, congress extension main unit or 8-channel audio input interface

26. Dante interface

- Connecting the conference main unit to the Dante network to receive digital audio signals
- Primary port: Dante2.

2.3 Installation

The transmitter can be fixed in a standard 19-inch cabinet. The transmitter is equipped with a pair of fixing brackets ①. First unscrew the lateral screws ② from the housing. Then fasten the brackets with these screws and put the CMU in the cabinet. Finally fix the four holes ③ up with screws.

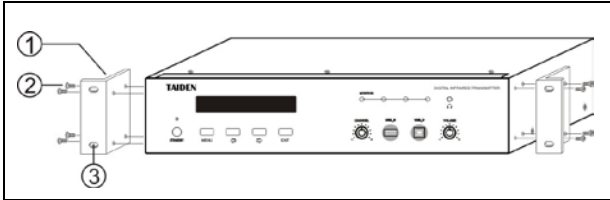

Figure 2.2 Installation of transmitter

In addition, 1U metal stripes are included as decoration to be installed between the transmitters in the cabinet. It is also good for the ventilation and cooling off. Fix up the four holes ③ with screws.

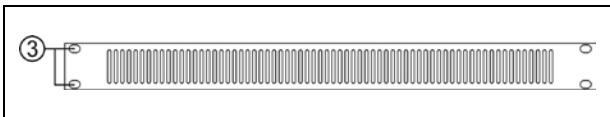

Figure 2.3 Decoration of cabinet

2.4 Connection

Typical system connection includes:

- to another transmitter
- to external audio sources
- to emergency signal switch
- to interpreter unit
- to HCS-8300 Paperless Multi-media Congress System or HCS-4100/50 Fully Digital Congress System

2.4.1 To another transmitter

■ Bypass (master + bypass) mode

The transmitter can be operated in bypass mode to loop-through the IR radiator signals from another transmitter. Multi room application can be achieved by setting the transmitter in the center room to “Master” mode and the transmitters in other rooms to “Bypass” mode. One of the six radiator outputs of the master transmitter is connected with an RG-59 cable to the radiator signal loop-through input of the bypass transmitter.

2 Transmitters should be set to “Master” and “Bypass” separately (see section 2.6.1).

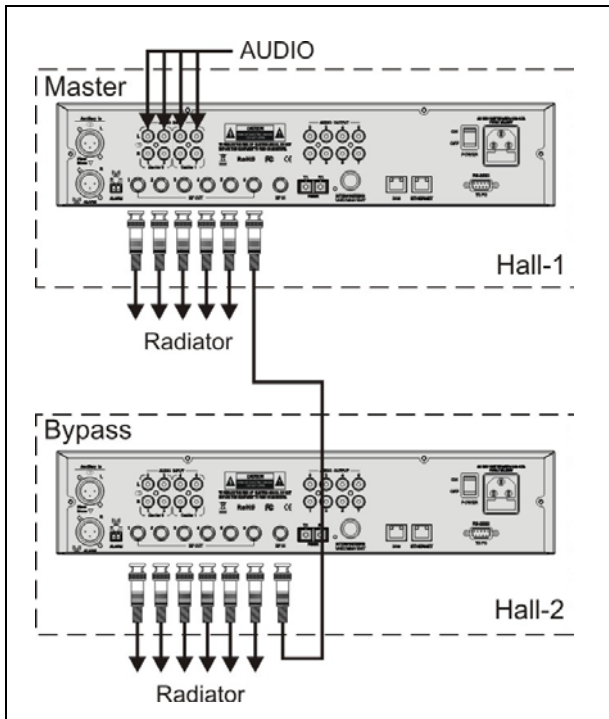

Figure 2.4 Transmitter connected to another transmitter in bypass mode

2.4.2 To external audio sources

HCS-5100M/F transmitter has up to 40 audio inputs (depends on transmitter type) for connecting to external unbalanced audio sources (such as other brand conference systems) or for music distribution.

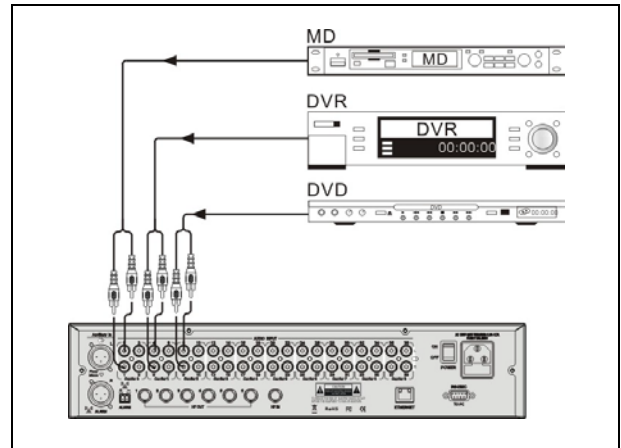

Figure 2.5 Transmitter connected to external audio sources

2.4.3 To emergency signal switch

To use emergency function, fire alarm linked trigger interface (normally open) must be connected to the emergency switch connector. When the switch is closed, the audio signal on the Aux-Right input is distributed to all output channels and overriding all other audio inputs.

“ALARM” will be displayed on the LCD at this moment.

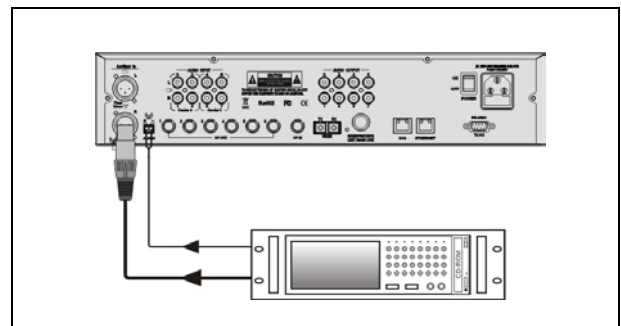

Figure 2.6 Transmitter connected to emergency signal switch

2.4.4 To interpreter unit

Interpreter units (HCS-4385U/50 or HCS-8385/80) can be connected to the interpreter's unit interface of HCS-5100MA/F. It must be ensured that, during the installation, the sum of the total power consumption of all the interpreter units connected to the 6P-DIN interface plus the power loss in the extension cables does not surpass the power limit of the 6P-DIN interface. Otherwise the system will not work properly or automatic protection will occur (see table 2.1).

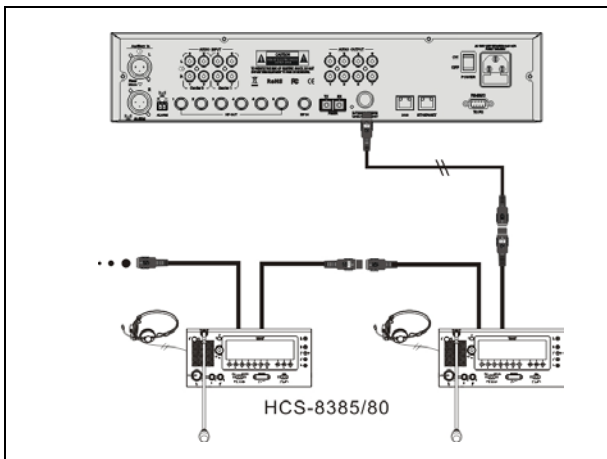

Figure 2.7 Transmitter connected to interpreter units

Table 2.1 Quick lookup table for the max. number of interpreter units (unit: pcs)

Type No.	The extension cable length between the CMU and the first interpreter Unit connected to the socket			
	20 m	40 m	60 m	80 m
HCS-4385U/50	14	11	8	6
HCS-8385	9	7	5	4

***Note:** Cable Splitter HCS-4352T is needed when the length of an extension cable exceeds 80 m.

(Cable splitter is used as repeater only and cannot improve load capability.)

2.4.5 To HCS-8300 Paperless Multi-media Congress System

■ HCS-5100MA/F connected to HCS-8300 Paperless Multi-media Congress System

HCS-8300M congress main unit can be connected via optical fiber interface (HCS-5100MA/FS/F), 6P-DIN interface or DCS interface on HCS-5100MA/F, and 4, 8 or 16 channels audio output can be used for audio recording (see figure 2.8).

■ HCS-5100MC/F connected to HCS-8300 Paperless Multi-media Congress System

HCS-5100MC/F transmitter do not have optical fiber interface, 6P-DIN interface or DCS interface, it can be connected to TAIDEN HCS-8300M congress main unit through TAIDEN HCS-8300MO 8 Channels Audio Output Device. The output of HCS-8300MO should be connected to the audio input of HCS-5100MC/F transmitter one-to-one correspondingly through audio cable (see figure 2.9).

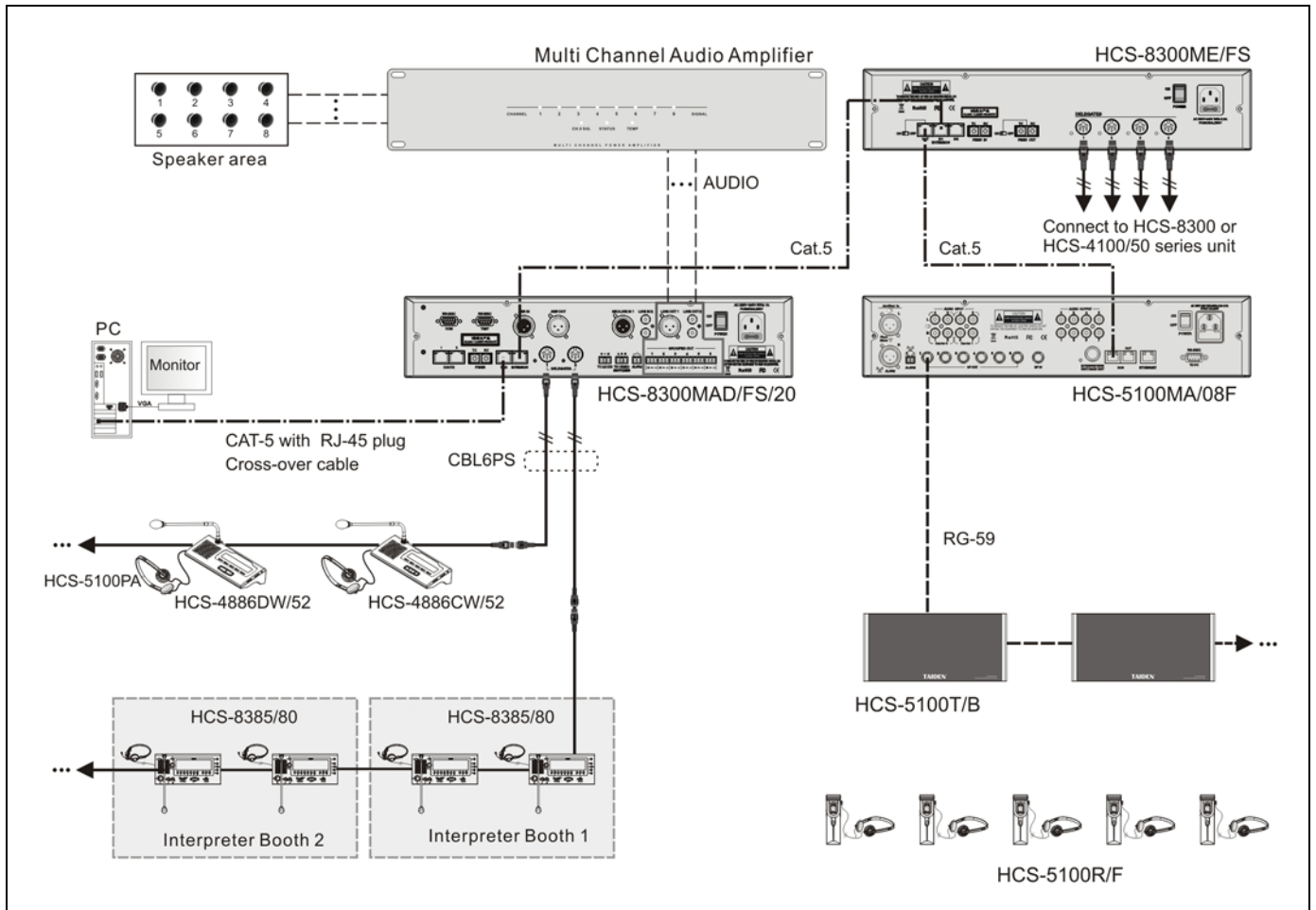

Figure 2.8 HCS-5100MA/F transmitter connecting to HCS-8300M congress main unit

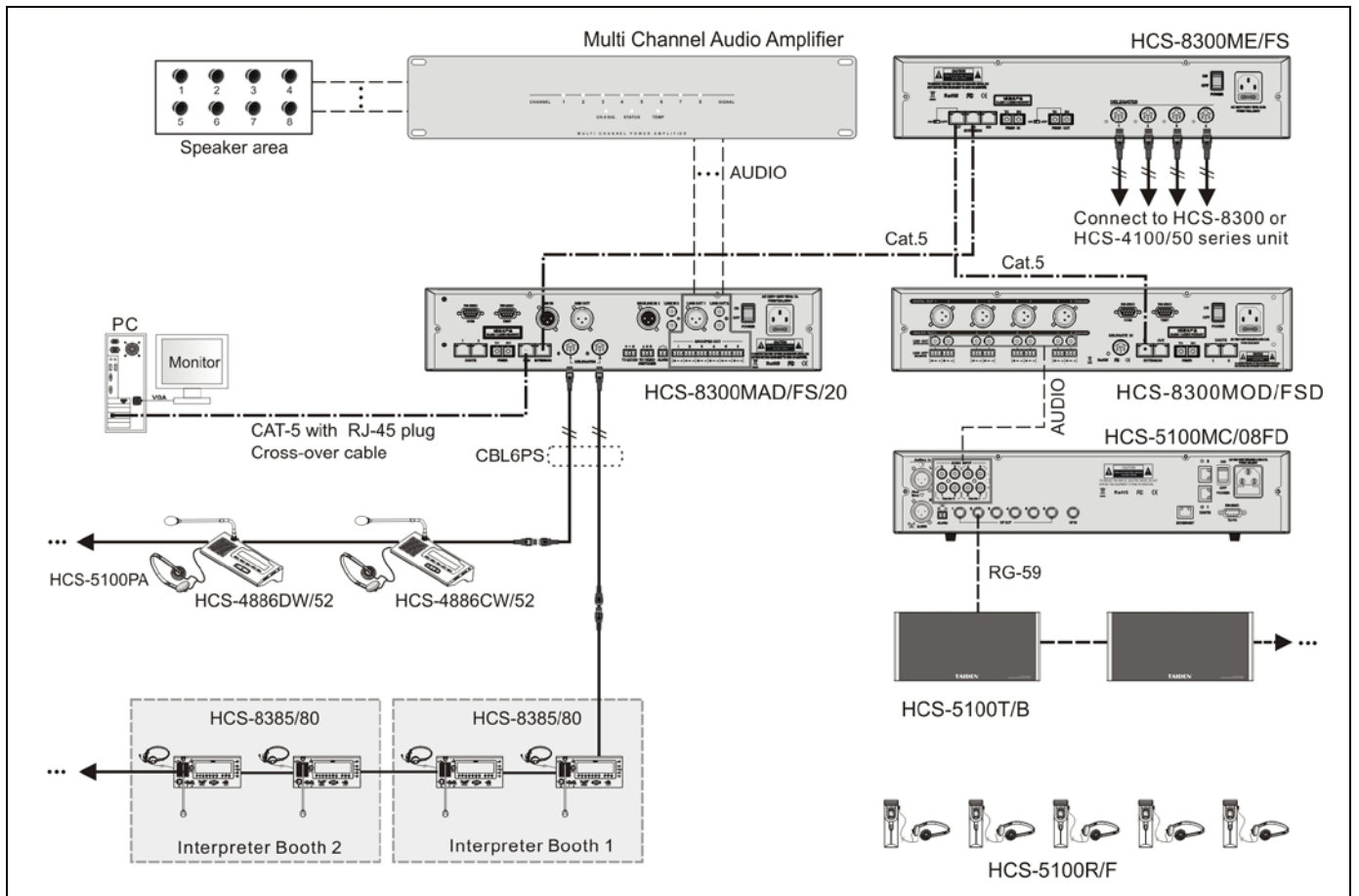

Figure 2.9 HCS-5100MC/F transmitter connecting to HCS-8300M congress main unit through HCS-8300MO

2.5 Menu structure

2.5.1 Transmitter menu structure (work mode: Master-Analog)

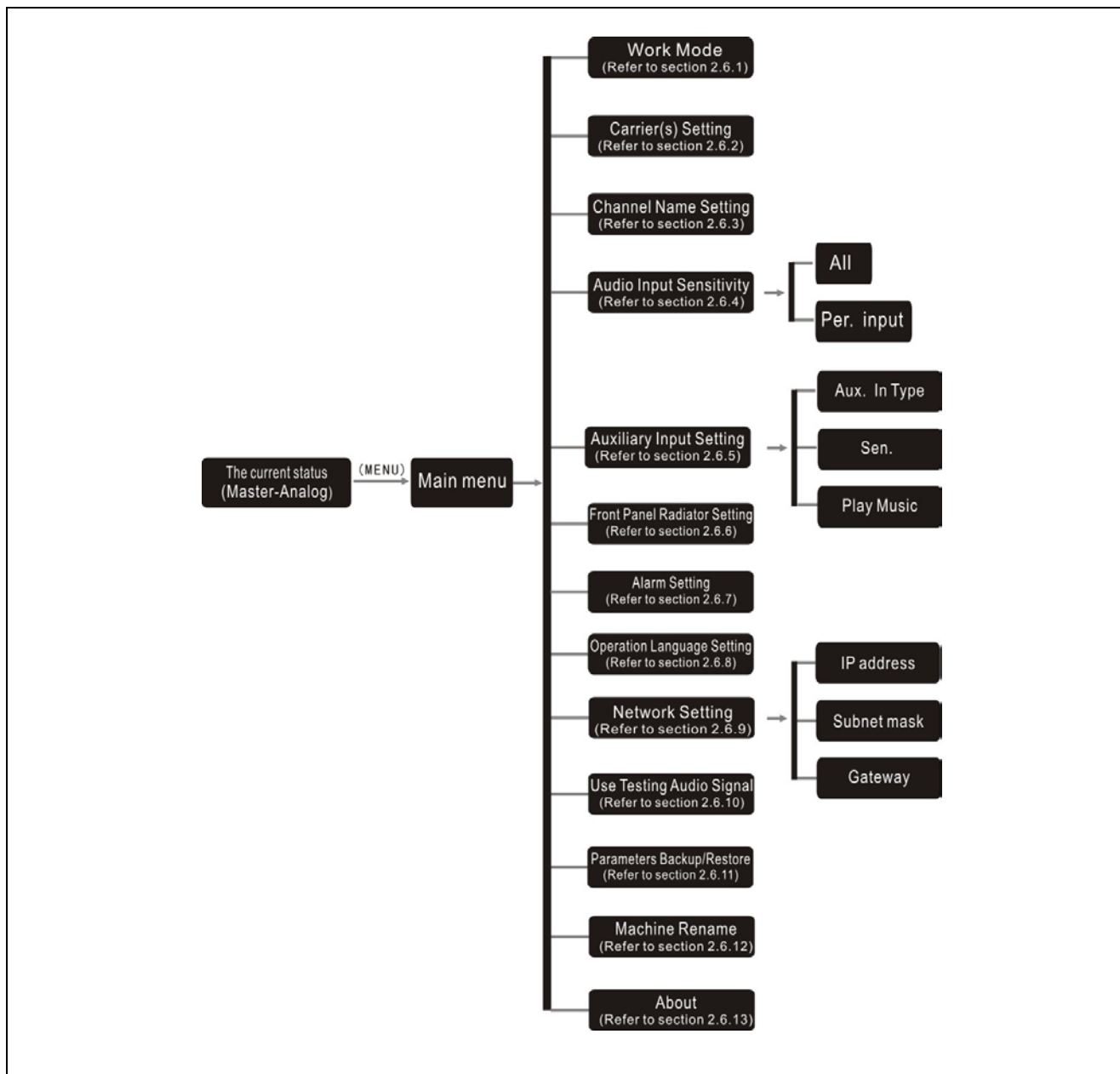

Figure 2.12a Transmitter menu structure (work mode: Master-Analog)

2.5.2 Transmitter menu structure (work mode: Master- Interp. U)

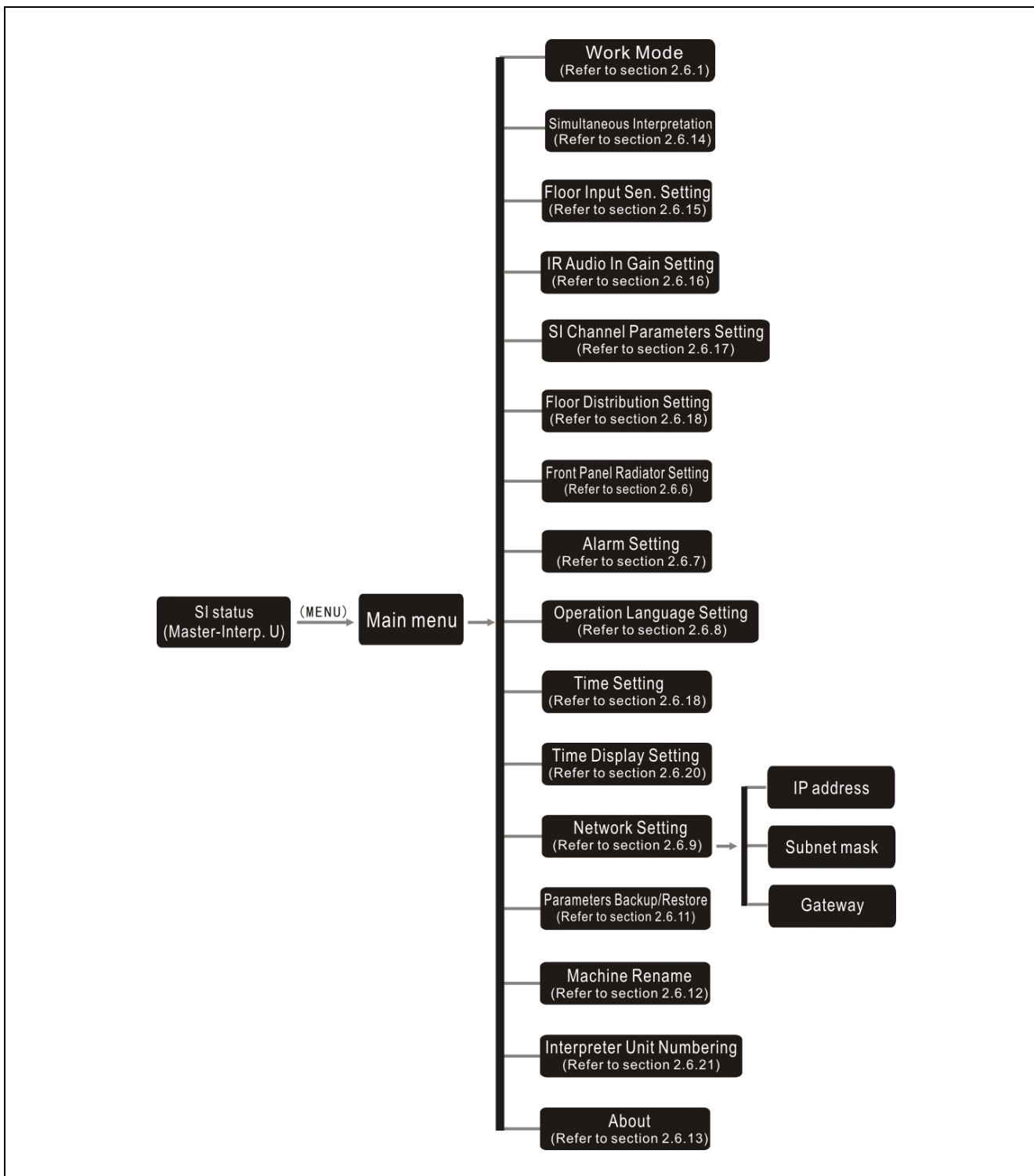

Figure 2.12b Transmitter menu structure (work mode: Master- Interp. U)

2.5.3 Transmitter menu structure (work mode: Master- Central U)

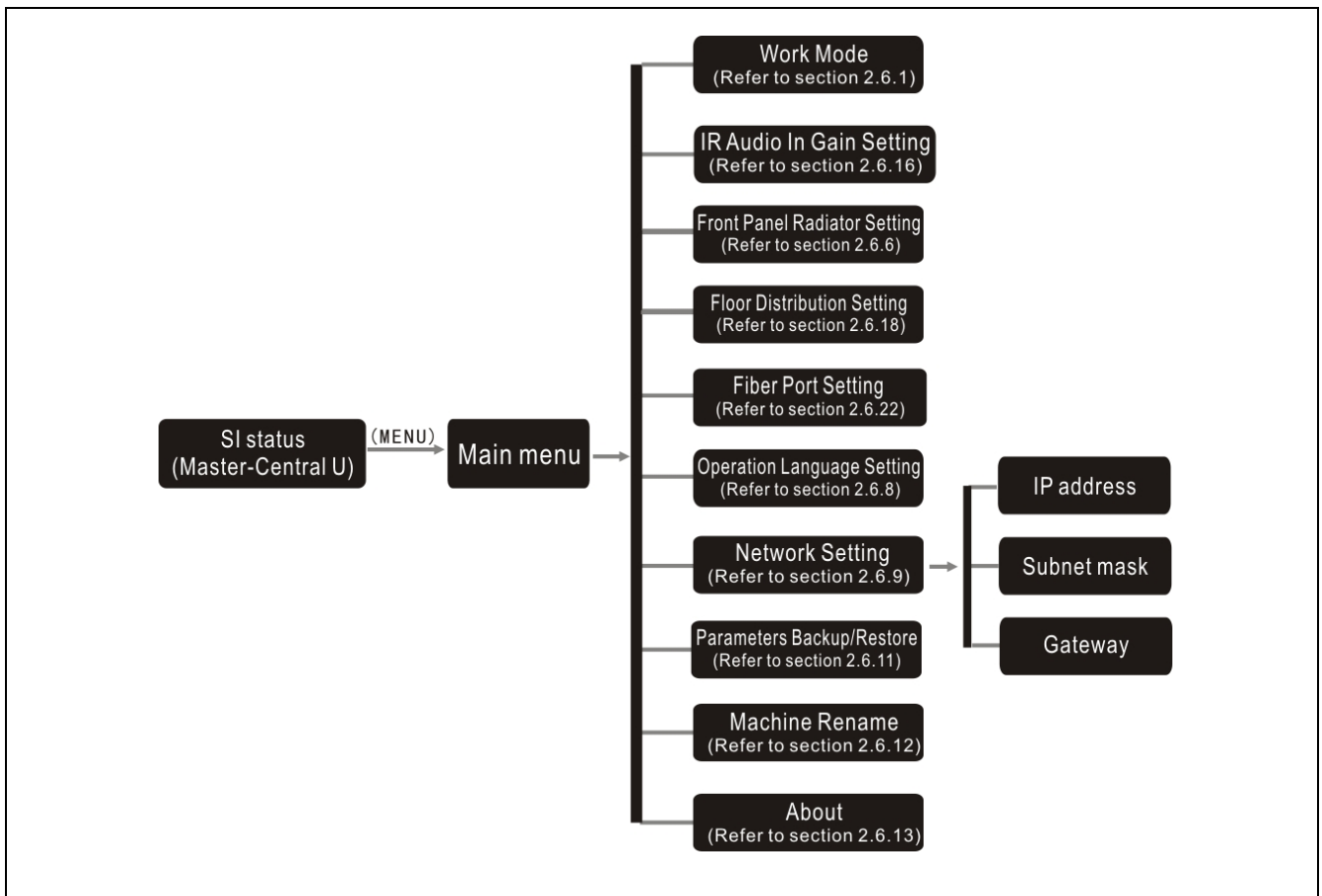

Figure 2.12c Transmitter menu structure (work mode: Master- Central U)

2.5.4 Transmitter menu structure (work mode: Master-Dante)

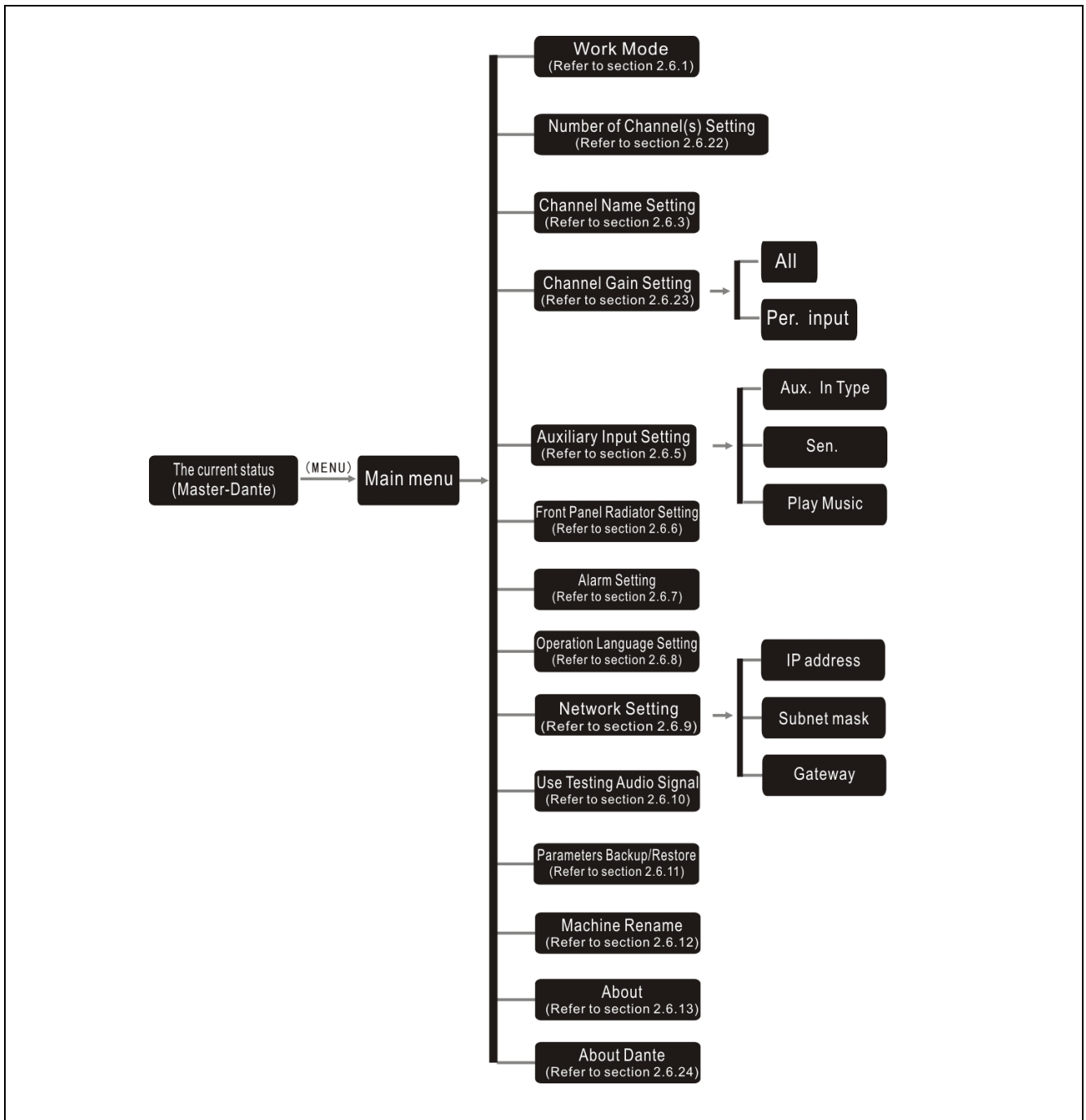

Figure 2.12d Transmitter menu structure (work mode: Master-Dante)

2.5.5 Transmitter menu structure (work mode: Bypass)

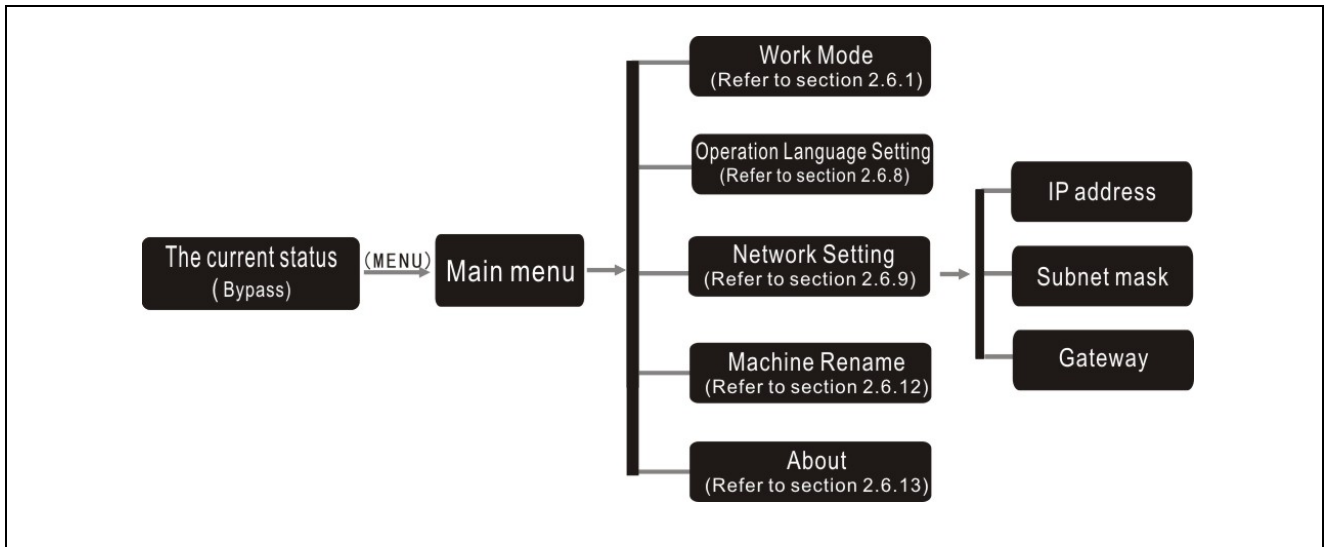

Figure 2.12e Transmitter menu structure (work mode: Bypass)

2.6 Configuration and operation

Via an interactive menu on the LCD and 4 operation buttons.

A) Starting initialization:

Switch on the HCS-5100M/F transmitter. The current status of the transmitter will be displayed on the LCD:

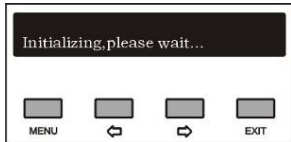

■ If the status is **“Master” mode**, passes different types of the master mode interfaces, it has different modes, include: “analog”, “interp. U”, “central. U” and “Dante”.

- **“Master – Analog” mode**

The display shows: “Total Channels”
“Monitor Channel”
“Audio Source”

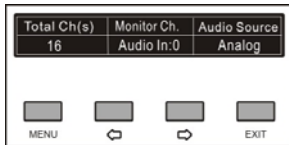

Please refer to [2.6.1](#) for detailed description.

- **“Master - Interp. U” mode**

When the HCS-5100MA/F transmitter is connected to the interpreter unit via the 6P-DIN interface, the simultaneous interpretation status will be displayed on the LCD. It once displays 8 channel status, presses the “←/→” button to turn pages.

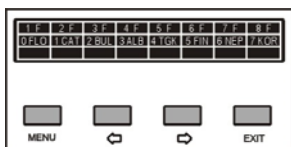

- **“Master - Central. U” mode**

When the HCS-5100MA/F transmitter is connected to the conference main unit via the DCS / 6P-DIN interface, the simultaneous interpretation status will be displayed on the LCD. It once displays 8 channel status, presses the “←/→” button to turn pages.

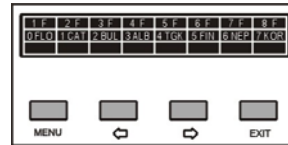

- **“Master - Dante” mode**

When the HCS-5100MC/FD transmitter is connected to the Dante network via the Dante interface, the simultaneous interpretation status will be displayed on the LCD. It once displays 8 channel status, presses the “←/→” button to turn pages.

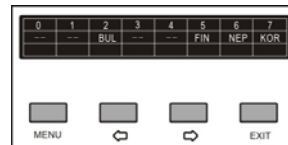

Note:

☞ Only one mode can be connected at a time, when switching another mode, please cut off the last connection at the same time.

■ If the status is **“Bypass” mode**, the display shows:
“Work mode”
“IP address”

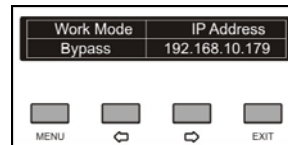

B) Accessing “Main” menu:

Press the “MENU” button. Depending on the transmitter work mode, the LCD display shows the terms:

In **“Master - Analog” mode**:

- “Work Mode”
- “Carrier(s) Setting”
- “Channel Name Setting”
- “Audio Input Sensitivity”
- “Auxiliary Input Setting”
- “Front Panel Radiator Setting”
- “Alarm Setting”
- “Operation Language Setting”
- “Network Setting”
- “Use Testing Audio Signal”

- “Parameters Backup/Restore”
- “Machine Rename”
- “About”

→“About Dante”

In “**Master - Interp. U**” mode:

- “Work Mode”
- “Simultaneous Interpretation”
- “Floor Input Sen. Setting”
- “IR Audio In Gain Setting”
- “SI Channel Parameters Setting”
- “Floor Distribution Setting”
- “Front Panel Radiator Setting”
- “Alarm Setting”
- “Operation Language Setting”
- “Time Setting”
- “Time Display Setting”
- “Network Setting”
- “Parameters Backup/Restore”
- “Machine Rename”
- “Interpreter Unit Numbering”
- “About”

In “**Bypass**” mode:

- “Work Mode”
- “Operation Language Setting”
- “Network Setting”
- “Machine Rename”
- “About”



- ◆ Press the “MENU” button to go to the corresponding submenus.
- ◆ To switch from term to term use the “←/→” button.
- ◆ To exit the current menu and to return to the upper level menu use the “EXIT” button.

In “**Master - Central U**” mode:

- “Work Mode”
- “IR Audio In Gain Setting”
- “Front Panel Radiator Setting”
- “Floor Distribution Setting”
- “Fiber Port Setting”
- “Operation Language Setting”
- “Network Setting”
- “Parameters Backup/Restore”
- “Machine Rename”
- “About”

2.6.1 Work Mode

a) Use the “←/→” button to switch between “Master” and “Bypass”;

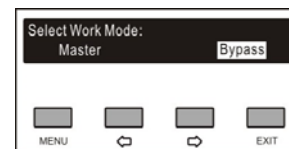

- ◆ “Master”, use the “MENU” button to confirm and go to step b);
- ◆ “Bypass”, use the “MENU” button to confirm and go to step c);

b) Use the “←/→” button to select the master mode interface;

In “**Master - Dante**” mode:

- “Work Mode”
- “Number Of Channel(s) Setting”
- “Channel Name Setting”
- “Channel Gain Setting”
- “Auxiliary Input Setting”
- “Front Panel Radiator Setting”
- “Alarm Setting”
- “Operation Language Setting”
- “Network Setting”
- “Use Testing Audio Signal”
- “Parameters Backup/Restore”
- “Machine Rename”
- “About”

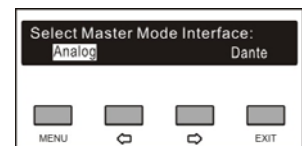
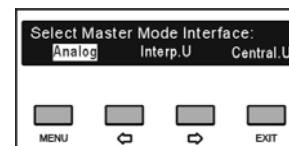

- ◆ “Analog”, SI audio signal input from AUDIO IN interfaces of transmitter;
- ◆ “Interp. U”, SI audio signal input from Interpreter unit(s) connected to the transmitter;
- ◆ “Central U”, SI audio signal input from main unit(s) connected to the transmitter;
- ◆ “Dante”, SI audio signal input from Dante network connected to the transmitter;

- c). Transmitter needs to restart to implement working mode configuration. Use the “↔” button to select reset now or not.

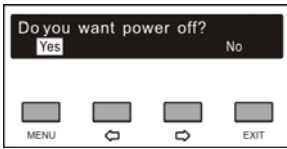

2.6.2 Carrier(s) Setting

- Setting up**
- “Set up status”
 - “Carrier Frequency Setting”
 - “Channel number”
 - “Audio quality”
 - “Save settings”

1) Set up status

Enable/disable current carrier.

- a) Use the “↔” button to enable or disable the current carrier;
- b) Use the “MENU” button to save;

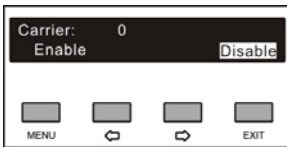

- “Enabled”: Press “MENU” to go to step 2);
- “Disabled”: Press “MENU” to return to the upper level menu.

2) Carrier frequency setting

- a) Use the “↔” button select a frequency.

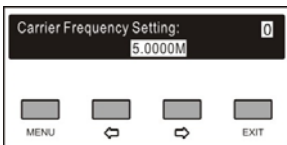

- b) Use the “MENU” button to the save.

3) Channel number

- a) Use the “↔” button to increase or decrease the channel number. The exact channel number depends on the audio quality (see section [1.2.5](#)).

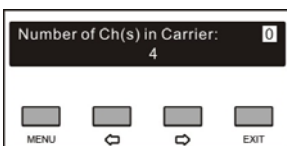

- b) Use the “MENU” button to the save channel number setting.

4) Audio quality

- a) Go to the audio quality setting interface;

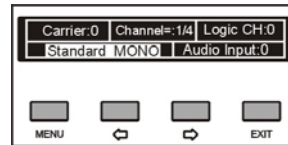

- b) Press the “MENU” button to switch channel number (in the case of more than one channel). “Audio input:” indicates the current channel corresponding to the HCS-5100M transmitter audio input channel;
- c) After having selected channel number(s), use “↔” to adjust audio quality.

- Audio mode includes:**
- “Standard MONO”
 - “Perfect MONO”
 - “Standard STEREO”
 - “Perfect STEREO”

The selectable audio quality depends on the channel number (refer to section [1.2.5](#)).

5) Save settings

- a) Use the “MENU” button to save setting;
- b) Go to the next carrier configuration;
- c) Repeat above until all carriers have been set up.

2.6.3 Channel Name Setting

Assign a language name for every channel.

- a) Use the “MENU” button to switch the channel number;
- b) Use the “↔” button to adjust the current channel name (for selectable language name refer to section [8.8](#)).

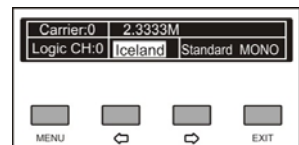
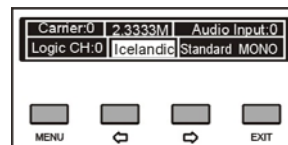

2.6.4 Audio Input Sensitivity

“Input sensitivity” includes 2 submenus:

- **“All”**: adjust all channels input sensitivity
- **“Per. Input”**: adjust each channel input sensitivity separately

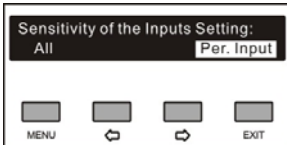

- **“All”**:

Use the “←/→” button to adjust the max. level for all audio inputs. Range from -12 dBV - +12 dBV.

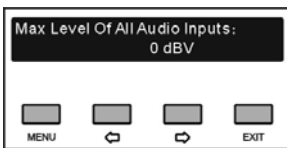

- **“Per Input”**:

- Use the “MENU” button to switch channel number
- Use the “←/→” button to adjust the max. level for each audio input. Range from -12 dBV - +12 dBV.

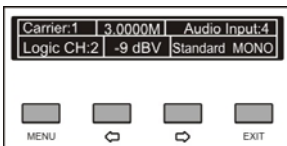

2.6.5 Auxiliary Input Setting

“Aux. Input” (Auxiliary audio input) includes 3 submenus:

- “Aux. In Type”
- “Sen.”
- “Play Music”

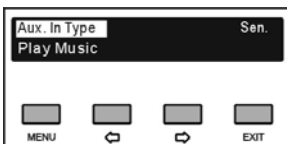

- **“Aux Input Type”**

Use the “←/→” button to select the auxiliary input type between “Stereo Music” and “Mono + Emergency”.

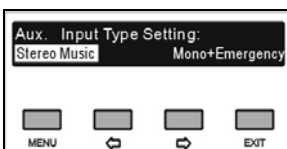

- **“Stereo Music”**:

If “Play music”, stereo music from 2 channels auxiliary audio input will be distributed to all output channels, usually for playing music when adjournment.

- **“Mono + Emergency”**:

Once the alarm signal is turned on, the emergency signal from Aux-R audio input will be distributed to all output channels on the premise that fire alarm linked trigger interface is closed (see section [2.4.3](#)).

- **“Sen. (sensitivity)”**

Use the “←/→” button to adjust the auxiliary input level, range from -6 dBV - +18 dBV.



- **“Play Music”**

- If “Aux input type” is “Stereo music”, stereo or mono music from the auxiliary audio input will be distributed to all output channels. “MUSIC” will be displayed at this moment;
- Use the “MENU” button to stop and exit.

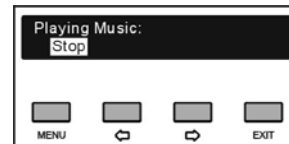

2.6.6 Front Panel Radiator Setting

Enable/disable the front panel radiator. If “Enable”, the infrared signal can be monitored or tested via the front panel radiator.

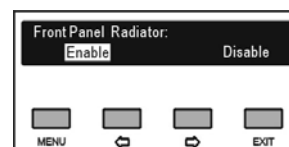

- Press the “←/→” button to select enable or disable the front panel radiator;
- Press the “MENU” button to save and return to the upper level menu.

2.6.7 Alarm Setting

Enable alarm function or not.

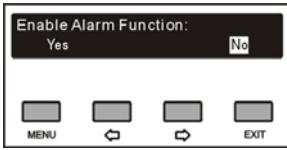

- Use the "←/→" button to select "Yes" or "No";
- Press the "MENU" button to save and return to the upper level menu.

2.6.8 Operation Language Setting

Select the LCD display language from simplified Chinese, Traditional Chinese, English, etc. Other languages can be added by the user through LCD_Designer software operation.

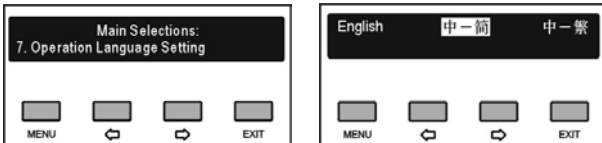

- Press the "←/→" button to select the LCD display language;
- Press the "MENU" button to save and return to upper level menu.

2.6.9 Network Setting

"Network" includes three submenus:

- "IP Address"
- "Subnet Mask"
- "Gateway"

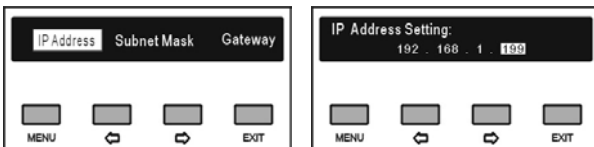

1) Setting up unique "IP Address" for the transmitter:

- Use the "←/→" button to switch between the four numbers;
- Use the "MENU" button to edit the selected number;
- Use the "←/→" button to decrease/increase the number (press and hold the "←/→" button will adjust the numeric value quickly);
- Use the "EXIT" to return to the upper level menu.

2) Setting up "Subnet Mask" and "Gateway":

Same chronological order as for the "IP address" set up.

Note:

- ☞ "IP address", "Subnet Mask" and "Gateway" of the system software should correspond with the above transmitter settings, else connection error will occur;
- ☞ All menu setup except "Network" and "Input sen." use the "MENU" button to exit saving changes, and use "EXIT" to exit discarding changes.

2.6.10 Use Testing Audio Signal

The transmitter goes to testing mode and testing tone will be distributed to all output channels.

Use the "MENU" button or "EXIT" button to stop the testing mode.

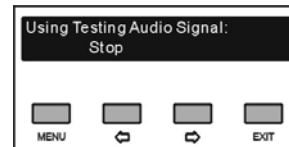

2.6.11 Parameters Backup/Restore

System parameters can be backed up or restored through the panel USB port. Make sure that the USB disk is properly connected, otherwise it will prompt "Please insert the USB disk."

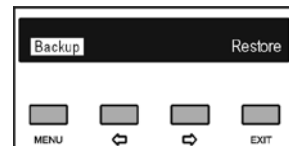

- Press the "←/→" button to select "Backup" or "Restore";
 - If "Backup" is selected, system parameters can be backed up;
 - If "Restore" is selected, system parameters can be restored;
- Press the "MENU" button to confirm and to go to selected menu item;
- Return to upper level menu after backup and reboot after recovery.

2.6.12 Machine Rename

Set alias for the HCS-5100M with a maximum length of 16 characters or less.

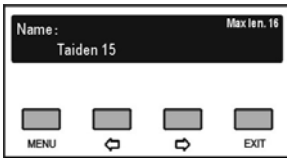

- Press the "MENU" button to enter the name setting interface;
- Press the "←/→" button to move the cursor;
- Press the "MENU" button to modify the character;
 - Press the "←" button to clear all the characters after the cursor;
 - press the "→" button to select the new characters;
- Press the "MENU" button to save at each character;
- Press the "EXIT" button to return to the upper level menu after setting finished.

2.6.13 About

Transmitter firmware information will be displayed, including: version, main unit information and product series number. Use the "EXIT" button to return to the upper level menu.

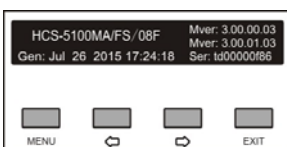

2.6.14 Simultaneous Interpretation

In "Simultaneous Interpretation" submenu, the following parameters need to be setup:

- ◆ "Select Number of Channel(s):"
- ◆ "Select Language for Channel:"
- ◆ "Select Number of Booth(s):"
- ◆ "Set Interlock Mode Between Booths:"
- ◆ "Interlock Mode in a Booth Setting"
- ◆ "Set Switch Outgoing Channel When Mic. On"
- ◆ "Select Language of Output Channel for Booth:"
- ◆ "Auto-Relay Booth Setting"

Operation steps:

a). Setup the number of interpretation channels

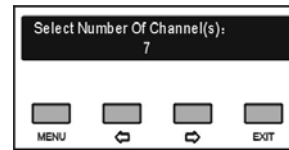

Use the "←/→" button to switch the number of interpretation channels (press and hold the "←/→" button will adjust the numeric value quickly);

- ◆ If "0" is selected, it stands for no SI function, use the "MENU" button to save and return to the main menu;
- ◆ If other values are selected, it stands for the number of interpretation channels, use the "MENU" button to go to step b).

b). Setup interpretation language

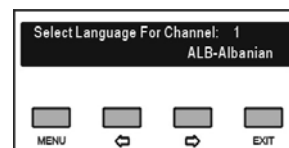

- Setup channel 1 first, use the "←/→" button to switch among languages;
- Use the "MENU" button to confirm the selected language and go to the next channel;
- Repeat 1) - 2) to set up the language for all channels, and go to step c);

c). Select number of booths

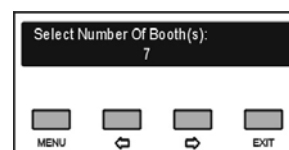

Use the "←/→" button to switch the number of interpreter booths. Usually, one language will take one booth.

- ◆ If "0" is selected, it stands for no SI function, use the "MENU" button to save and return to the main menu;
- ◆ If other values are selected, it stands for the number of interpretation booths, use the "MENU" button to go to step d).

d). Set interlock mode between booths

Select interlock mode between booths, includes:

"INTERLOCK"

"OVERRIDE"

"OVERRIDE-BC"

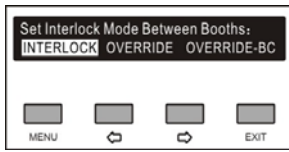

- 1). Use the "←/→" button to switch among the three interlock modes;
 - "INTERLOCK" mode prevents that two booths engage the same channel.
 - "OVERRIDE" mode enables an interpreter unit in another booth to override an occupied channel in another booth, but supplying the same channel.
 - "OVERRIDE-BC" mode enables A/B/C channel of an interpreter unit in another booth to override an occupied B/C channel in another booth, but supplying the same channel; when an interpreter unit in another booth to override an occupied A channel in another booth, the "Microphone ON" indicators the occupied A channel will flash on the control panel for about 5 seconds.
- 2). Use the "MENU" button to confirm selected interlock mode and go to step e).

e). Set interlock mode in a booth

Select interlock mode in a booth, includes:

"INTERLOCK"

"OVERRIDE"

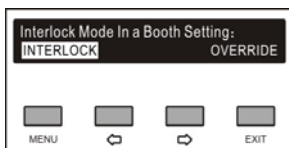

- 1). Use the "←/→" button to switch between interlock modes;
 - "INTERLOCK" mode prevents that two interpreter units in a booth engage the same channel.
 - "OVERRIDE" mode enables an interpreter unit to override an occupied channel in the same booth, but supplying the same channel.
- 2). Use the "MENU" button to confirm selected interlock mode and go to step f).

f). Set switch outgoing channel When mic. on

Set switch outgoing channel when microphone on for HCS-8385.

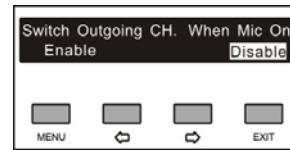

- 1). Use the "←/→" button to switch between "Enable" and "Disable",
- 2). Use the "MENU" button to confirm and go to step g)

g). Select language of output channel for the booth

To distribute the interpretation languages separately, A/B/C channels are provided in each interpretation unit. The language setting of A/B/C channels for all interpreter units in one booth is uniform. After the setup of booth numbers, the user interface to set up output the channel A/B/C language will be shown for each booth.

- 1). Setup channel A language for booth 1: press the "←/→" button to select the language from those languages that have been selected in step b) and press the "MENU" button to confirm;

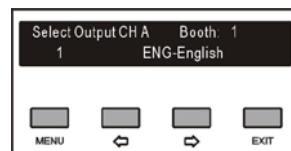

- 2). Select channel C language for booth 1: "None" or "All";

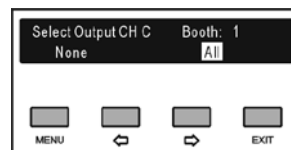

- If "All" is selected for C then press the "←/→" button to select the language for B from those languages that have been selected in step b) and press the "MENU" button to confirm;

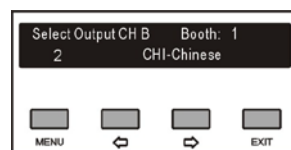

- If "None" is selected for C then select channel B language from "None" or "All";

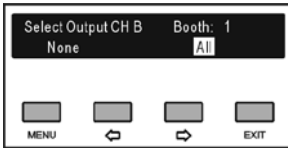

- ♦ “None” stands for no language output from channel B;
- ♦ “All” stands for the language of channel B which can be any of the selected languages.

Press the "MENU" button to confirm and go to configuration for next booth;

- 3). Repeat 1) - 2) to setup output channel A/B/C language for all booths;
- 4). Use the “MENU” button to confirm selected interlock mode and go to step h).

h). Auto-Relay booth Setting

Setup Auto-Relay booth.

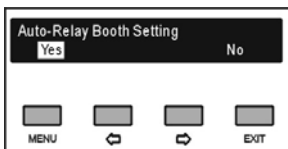

- 1). Press the “↔” button to select yes or no
 - If select “No”, press the menu button to confirm;
 - If select “Yes”, press the “MENU” button to confirm and go to next step;

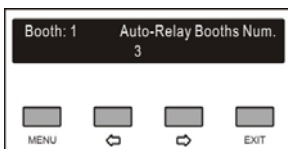

- 2). Press the “↔” button to select auto-relay booth number and press the “MENU” button to go to the next step;

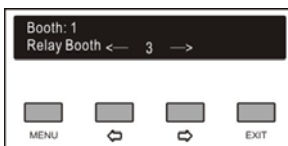

- 3). Press the “↔” button to select auto-relay booth and press the “MENU” button to confirm, then the corresponding booth number will be highlighted and set as auto-relay booth, press “MENU” again to cancel the setting.
- 4). Press the “↔” button to select next auto-relay booth until all auto-relay booths have been set;

Note:

☞ If channel B and C of a booth have no output, this booth can not be set as auto-relay booth.

2.6.15 Floor Input Sen. Setting

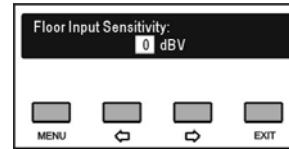

- a). Use the “↔” button to adjust the floor input sensitivity, range from -6 dBV - +18 dBV;
- b). Press the "MENU" button to save and return to the upper level menu.

2.6.16 IR Audio In Gain Setting

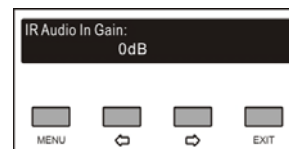

- a). Use the “↔” button to adjust the IR audio in gain, range from -6 dB - +6 dB;
- b). Press the "MENU" button to save and return to the upper level menu.

2.6.17 SI Channel Parameters Setting

Monitor the language channels and set up their states. Press the “MENU” button to view the channel state. If a channel has not been fed with language output temporarily, the LCD displays as in the following figure:

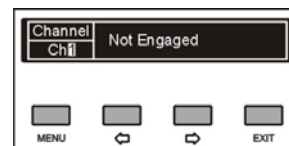

If the microphone of the Interpreter unit in the booth is active, the audio parameters of the Interpreter unit will be displayed as in the following figure and can be adjusted:

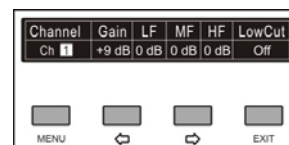

Under channel state interface, press “MENU” to select the channel number or parameter and press “↔” to change the channel number or parameter.

Note:

☞ The setting of LF/MF/HF is only effective for HCS-4385U/50.

2.6.18 Floor Distribution Setting

Enable/disable switch to floor channel automatically when no interpretation channel is available.

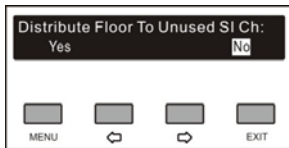

- a). Use the “↔” button to select “Yes” or “No”;
- b). Press the "MENU" button to save and return to the upper level menu.

2.6.19 Time Setting

Setup system clock.

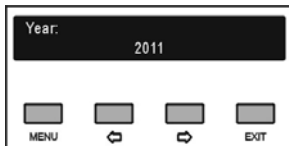

- a). Press the "MENU" button to go to "Year", "Month", "Day", "Hour", "Minute" in turn;
- b). Press the “↔” button to set time (press and hold “↔” will adjust the numeric value quickly);
- c). Press the "MENU" button to save and return to the upper level menu.

2.6.20 Time Display Setting

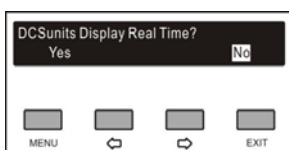

- a). Use the “↔” button to select “Yes” or “No”;
- b). Press the "MENU" button to save and return to the upper level menu.

2.6.21 Interpreter Unit Numbering

All HCS-4385U/50 interpreter units must be numbered when the system is used for first time or when adding or replacing interpreter units.

- a). Press “MENU” to enter numbering starts, the indicating light “B” of all connected interpreter units will be on and the CMU LCD will display as follow:

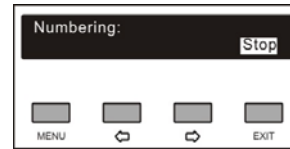

- b). Rotate the primary knob on the interpreter unit to select the number (rang: 1-6), and press key “B” to confirm;
- c). Press the “EXIT” button to stop number and return to the upper level menu.

Note:

☞ Interpreter unit numbering is only effective for HCS-4385U/50.

2.6.22 Fiber Port Setting

Enable/disable the fiber port.

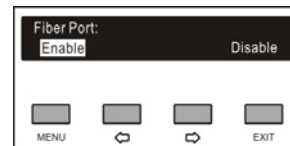

- a). Use the “↔” button to select “Enable” or “Disable”;
- b). Press the "MENU" button to save and return to the upper level menu.

2.6.23 Number of Channel(s) Setting

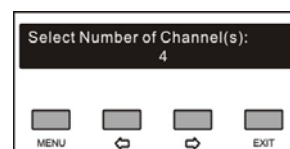

- a). Use the “↔” button to set number of audio input channel, rang: 0-16;
- b). Press the "MENU" button to save and return to the upper level menu.

2.7 Monitor

2.6.24 Channel Gain Setting

“Input sensitivity” includes 2 submenus:

- “All”: adjust all channels input gain
- “Per. Input”: adjust each channel input gain

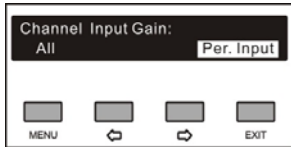

- “All”:

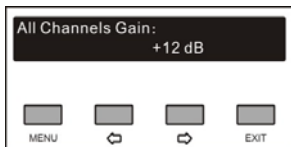

Use the “←/→” button to adjust the gain for all audio inputs. Range from -12 dB - +12 dB.

- “Per Input”:

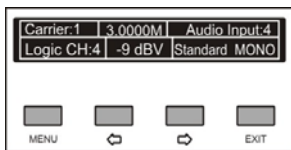

- Use the “MENU” button to switch channel number
- Use the “←/→” button to adjust the gain for each audio input. Range from -12 dBV - +12 dBV.

2.6.25 About Dante

Dante software information will be displayed, including: Dante version, device version and device name. Use the “EXIT” button to return to the upper level menu.



For testing the transmitter, the front panel has a monitoring facility including a monitor channel selector, a monitor earphone jack and a monitor volume control knob (please refer to figure 2.1).

The Monitor channel will only work if the transmitter is working. Plug the earphone into the monitor earphone jack, and select the monitor channel with the monitor channel selector. The audio signal input and the auxiliary audio signal input of the transmitter will be monitored. The selected channel is displayed on the LCD.



After monitor channel selection, LCD will return to transmitter status interface. The monitor channel is updated to the channel selected at last.

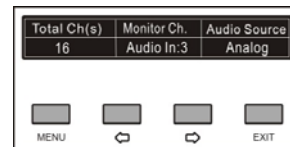

Monitor volume can be adjusted by monitor volume control knob between -30 dB and 0 dB. Default volume: -15 dB.

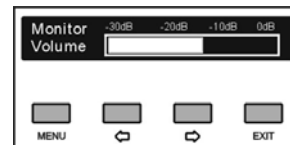

Chapter 3. HCS-5100M/A and HCS-5100M/B Series

Digital Infrared Transmitter

3.1 Overview

The HCS-5100M/A & HCS-5100M/B transmitter is the heart of the HCS-5100Plus system. Up to 40 unbalanced audio signals can be accepted (under combination mode) via digital/analog audio signal input connectors. It can be connected to HCS-4100M/50 HCS-4800M, HCS-8300M or HCS-8600M congress main unit directly via optical fiber interface, or DCS interface (RJ45 standard socket), and it can also be connected to other discussion and interpretation systems, or be used as a stand-alone system for distributing external audio signals. The transmitter is suitable for either tabletop or 19-inch rack mounting using.

Types:

HCS-5100MA/FS/04A/08A/16A

4, 8, 16 CHs Digital Infrared Transmitter (compatible with interpreter unit or HCS-4100M/HCS-8300M, single-mode optical fiber interface)

HCS-5100MA/04A/08A/16A

4, 8, 16 CHs Digital Infrared Transmitter (compatible with interpreter unit or HCS-4100M/HCS-8300M)

HCS-5100MC/04AD/08AD/16AD/40AD

4, 8, 16, 40 CHs Digital Infrared Transmitter (with Dante interface)

HCS-5100MC/04A/08A/16A/32A/40A

4, 8, 16, 32, 40 CHs Digital Infrared Transmitter

HCS-5100MA/FS/08/16B

8, 16 CHs Digital Infrared Transmitter ((compatible with HCS-4100M/HCS-8300M/HCS-4800M/HCS-8600M or HCS-4385U/50 interpreter unit,HCS-8685 interpreter unit can be connected via HCS-4853T cable splitter,single-mode optical fiber interface)

HCS-5100MA/04/08B

4, 8 CHs Digital Infrared Transmitter (compatible with HCS-4100M/HCS-8300M/HCS-4800M/HCS-8600M or HCS-4385U/50 interpreter unit,,HCS-8685 interpreter unit can be connected via HCS-4853T cable splitter)

HCS-5100MC/08/16/40BD

8, 16, 40 CHs Digital Infrared Transmitter (Dante interface)

HCS-5100MC/40B

40 CHs Digital Infrared Transmitter

3.2 Functions and indications

3.2.1 HCS-5100M/A series

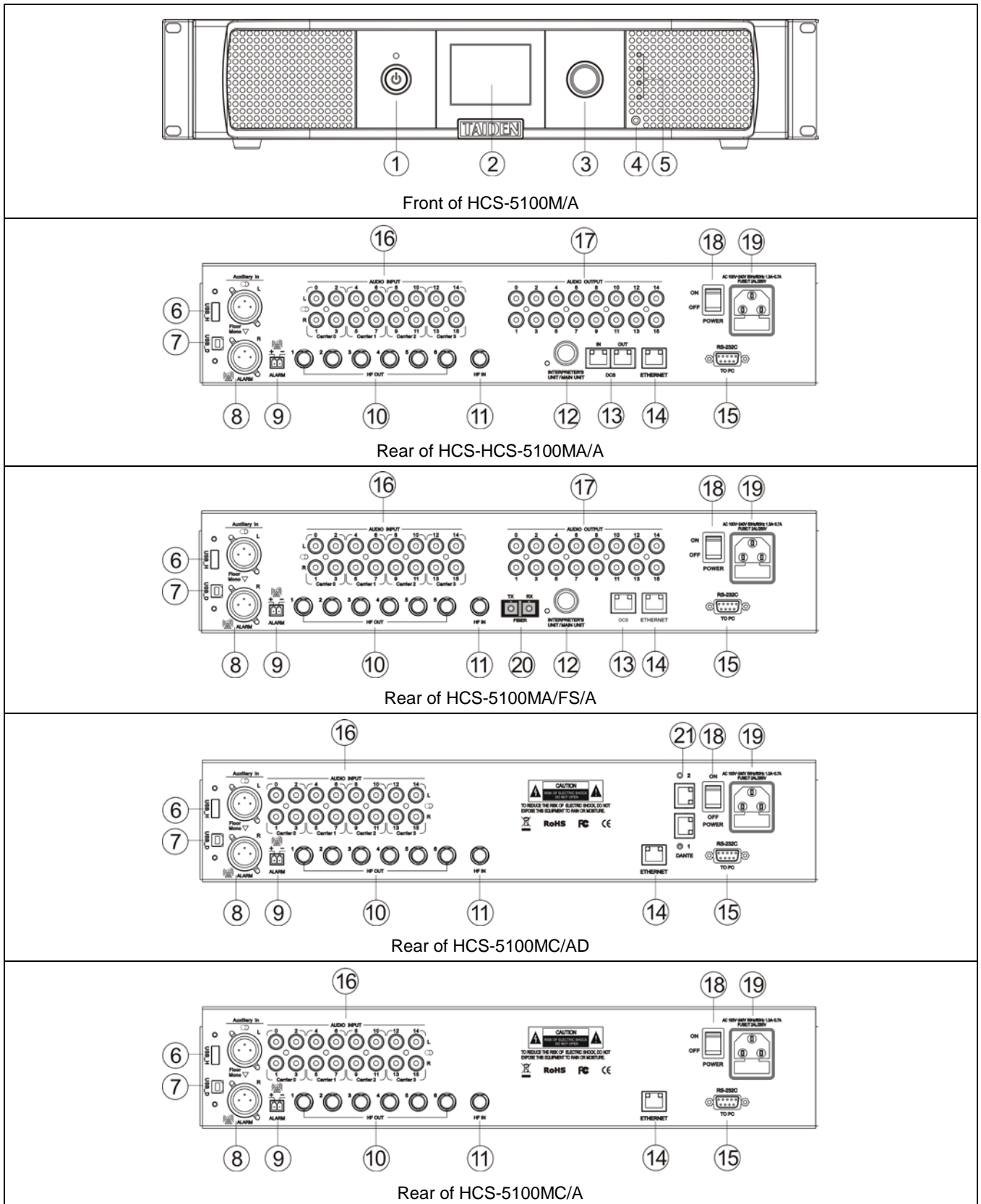

Figure 3.1 HCS-5100M/A Digital Infrared Transmitter

Figure 3.1:

1. Standby button with indicator

2. Menu display

- 2.8" LCD, displays main unit status and configuration menu.

3. Operation knob

- For LCD menu operation;

4. Monitor earphone interface

- Ø 3.5 mm jack for stereo monitor earphone

5. Mini IR radiator

- 4 IREDS transmitting the same infrared signal as the radiator output for monitor purpose

6. A type USB interface

- To plug-in a USB stick.

7. Mini USB interface (remain)

8. Auxiliary audio input

- 2 Female XLR connectors for external audio inputs to connect auxiliary balanced audio signals such as music, floor language or emergency audio signal

9. Fire alarm linked trigger interface

- When this switch is closed, the emergency audio signal on the Aux-R input is distributed to all output channels and overriding all other audio inputs

10. HF signal output

- 6 BNC connectors for output HF signal to radiator. To each connector, up to 30 radiators can be connected

11. HF signal input

- 1 BNC connector for receiving HF signal from other transmitter

12. Interpreter's unit / main unit

- For connecting to interpreter unit
- For connecting to HCS-4100M/50 or HCS-8300M congress main unit via CBL6PP-02 extension cable

13. DCS interfaces

- For connecting to HCS-4100M/50 or HCS-8300M congress main units

14. Ethernet

- For communication between the conference main unit and the PC under TCP/IP protocol to realize Web server and remote controlling; furthermore, it enables remote controlling by wireless touch panel through central control system

15. RS-232

- For connecting to a central control system for central controlling, as well as for system diagnosis

16. Audio signal input

- 4, 8, 16, 32 or 40 audio connectors to connect external unbalanced audio input signals. The number of connectors depends on the transmitter type

17. Audio signal output

- 4, 8, 16, 32 or 40 audio connectors. The number of connectors depends on the transmitter type

18. Power on/off

19. Power supply

20. Single-mode fiber, SC connector

- For connecting to the congress main unit, congress extension main unit or 8-channel audio input interface

21. Dante interface

- Connecting the conference main unit to the Dante network to receive digital audio signals

3.2.2 HCS-5100M/B series

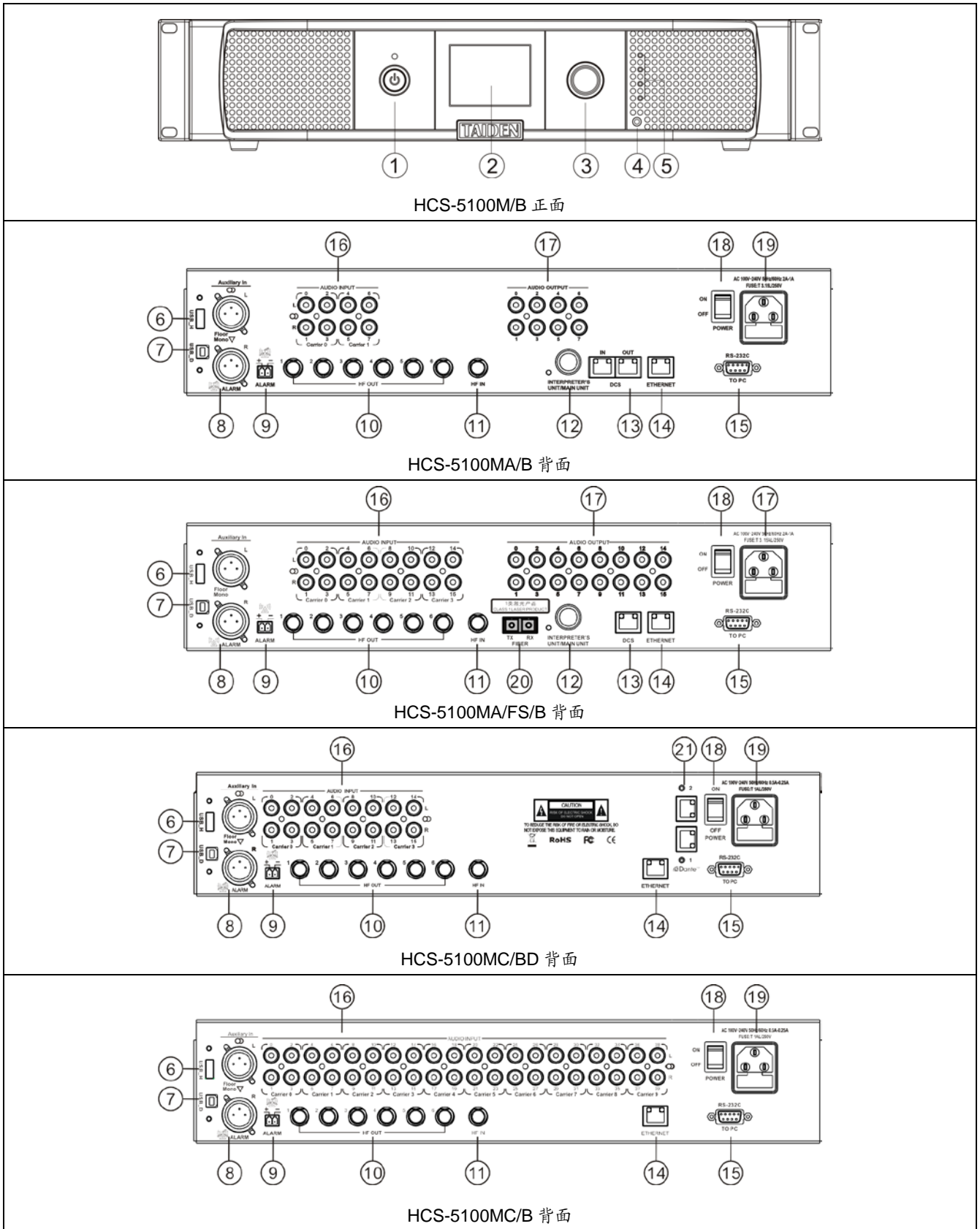

Figure 3.2 HCS-5100M/B Digital Infrared Transmitter

Figure 3.2:

1. Standby button with indicator

2. Menu display

- 2.8" LCD, displays main unit status and configuration menu.

3. Operation knob

- For LCD menu operation;

4. Monitor earphone interface

- Ø 3.5 mm jack for stereo monitor earphone

5. Mini IR radiator

- 4 IREDS transmitting the same infrared signal as the radiator output for monitor purpose

6. A type USB interface

- To plug-in a USB stick.

7. Mini USB interface (remain)

8. Auxiliary audio input

- 2 Female XLR connectors for external audio inputs to connect auxiliary balanced audio signals such as music, floor language or emergency audio signal

9. Fire alarm linked trigger interface

- When this switch is closed, the emergency audio signal on the Aux-R input is distributed to all output channels and overriding all other audio inputs

10. HF signal output

- 6 BNC connectors for output HF signal to radiator. To each connector, up to 30 radiators can be connected

11. HF signal input

- 1 BNC connector for receiving HF signal from other transmitter

12. Interpreter's unit / main unit

- For connecting to HCS-4385U/50 interpreter unit
- For connecting to HCS-8685 interpreter unit via HCS-4853T cable splitter
- For connecting to HCS-4100M/50 ,HCS-4800M or HCS-8300M congress main unit via CBL6PP-02 extension cable

13. DCS interfaces

- For connecting to HCS-4100M/50, HCS-4800M, HCS-8300M or HCS-8600M congress main units

14. Ethernet

- For communication between the conference main unit and the PC under TCP/IP protocol to realize Web server and remote controlling; furthermore, it enables remote controlling by wireless touch panel through central control system

15. RS-232

- For connecting to a central control system for central controlling, as well as for system diagnosis

16. Audio signal input

- 4, 8, 16, or 40 audio connectors to connect external unbalanced audio input signals. The number of connectors depends on the transmitter type

17. Audio signal output

- 4, 8, 16, or 40 audio connectors. The number of connectors depends on the transmitter type

18. Power on/off

19. Power supply

20. Single-mode fiber, SC connector

- For connecting to the congress main unit, congress extension main unit or 8-channel audio input interface

21. Dante interface

- Connecting the conference main unit to the Dante network to receive digital audio signals

3.3 Installation

HCS-5100M/A and HCS-5100M/B series Digital Infrared Transmitter can be fixed in a standard 19-inch cabinet. Put the main unit in the cabinet and fix the four holes up with screws ①.

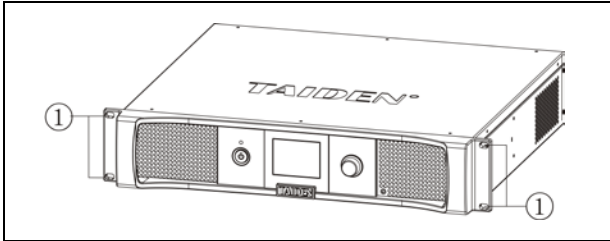

Figure 3.3 Installation of transmitter

In addition, 1U metal stripes are included as decoration to be installed between the transmitters in the cabinet. It is also good for the ventilation and cooling off. Fix up the four holes ③ with screws.

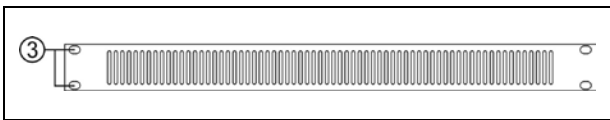

Figure 3.4 Decoration of cabinet

3.4 Connection

Typical system connection includes:

- to another transmitter
- to external audio sources
- to emergency signal switch
- to HCS-4385U/50 interpreter unit
- to HCS-8685 interpreter unit: HCS-8685 interpreter unit can be connected via HCS-4385T cable splitter, which is powered by HCS-5100M/B transmitter directly or by HCS-8300MES extension main unit while compatible with HCS-5100M/A transmitter.
- to HCS-4100/50 / HCS-4800 Fully Digital Congress System, or HCS-8300 / HCS-8600 Paperless Multi-media Congress System.

3.4.1 To another transmitter

■ Bypass (master + bypass) mode

The transmitter can be operated in bypass mode to loop-through the IR radiator signals from another transmitter. Multi room application can be achieved by setting the transmitter in the center room to “Master” mode and the transmitters in other rooms to “Bypass” mode. One of the six radiator outputs of the master transmitter is connected with an RG-59 cable to the radiator signal loop-through input of the bypass transmitter. 2 Transmitters should be set to “Master” and “Bypass” separately.

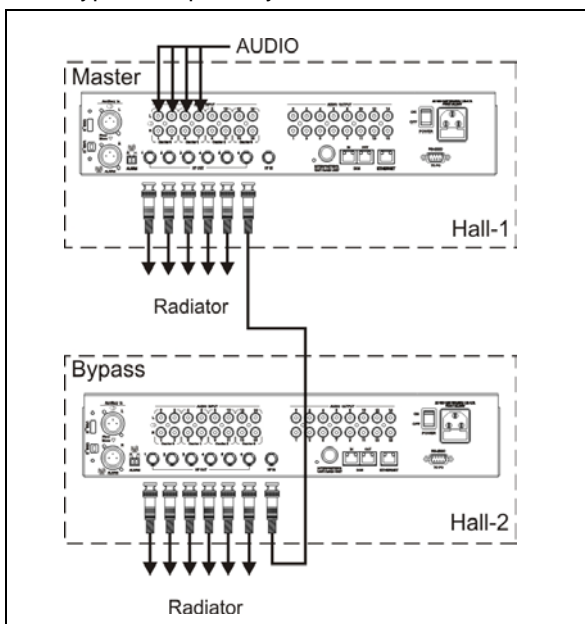

Figure 3.5 Transmitter connected to another transmitter in bypass mode

3.4.2 To external audio sources

The transmitter has up to 40 audio inputs (depends on transmitter type) for connecting to external unbalanced audio sources (such as other brand conference systems) or for music distribution.

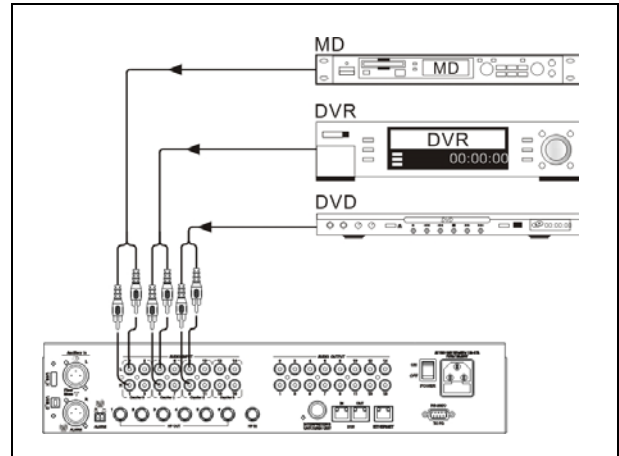

Figure 3.6 Transmitter connected to external audio sources

3.4.3 To emergency signal switch

To use emergency function, fire alarm linked trigger interface (normally open) must be connected to the emergency switch connector. When the switch is closed, the audio signal on the Aux-Right input is distributed to all output channels and overriding all other audio inputs.

“ALARM” will be displayed on the LCD at this moment.

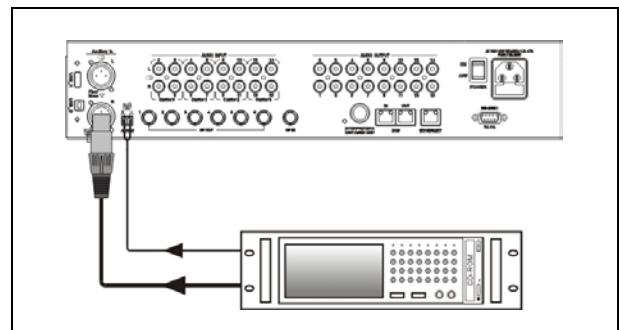

Figure 3.7 Transmitter connected to emergency signal switch

3.4.4 Connect to interpreter unit

- **Directly connect to HCS-4385U/50**

HCS-4385U/50 Interpreter units can be connected to the interpreter's unit interface of HCS-5100MA/A or HCS-5100MA/B transmitter. It must be ensured that, during the installation, the sum of the total power consumption of all the interpreter units connected to the 6P-DIN interface plus the power loss in the extension cables does not surpass the power limit of the 6P-DIN interface. Otherwise the system will not work properly or automatic protection will occur (see table 3.1).

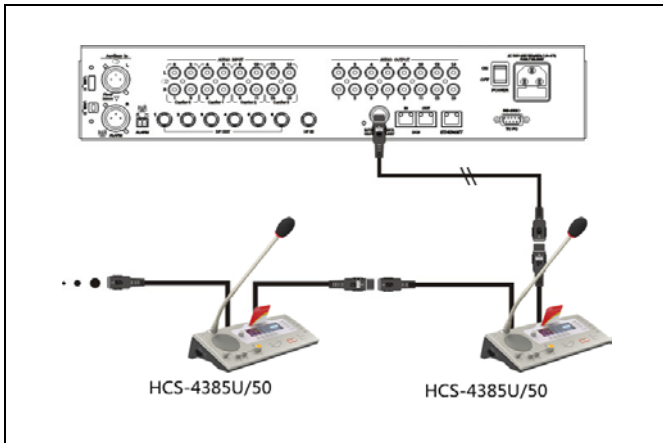

Figure 3.8 Transmitter connected to HCS-4385U/50

Table 3.1 Quick lookup table for the max. number of HCS-4385U/50 interpreter units (unit: pcs)

Scenarios		The extension cable length between the transmitter and the first interpreter Unit connected to the socket			
		20 m	40 m	60 m	80 m
①	Connect to HCS-5100M/A	14	11	8	6
②	Connect to HCS-5100M/B	22	22	19	16

***Note:**

In scenarios ①, HCS-4352T Cable Splitter is needed when the length of an extension cable exceeds 80 meters. (Cable splitter is used as repeater only and cannot improve load capability.)

- **Directly connect to HCS-8685 (Only HCS-5100MA/B)**

HCS-5100M/B series digital infrared transmitter can be connected to HCS-4853T cable splitter through 6P-DIN interface. HCS-4853T cable splitter has 3 8P-DIN output interfaces, which can be connected to the HCS-8685 translation units. Please note that the sum

of the total power consumption of all the interpreter units, plus the power loss in the extension cables does not surpass the power limit of the 6P-DIN interface of HCS-5100M/B (see table 3.2).

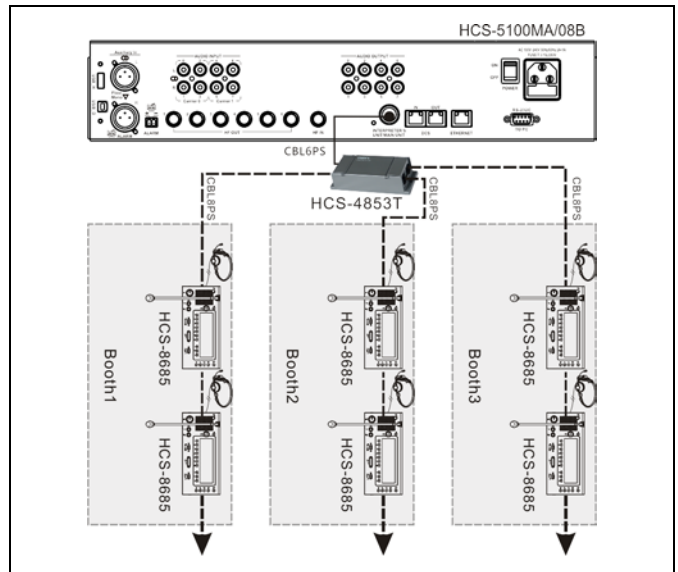

Figure 3.9 HCS-5100M/B connected to HCS-8685

Table 3.2 Quick lookup table for the max. number of HCS-8685 interpreter units connect to HCS-5100M/B via HCS-4853T (unit: pcs)

Scenarios	Extension cable Length	The max. number of 8685 interpreter units in total
Extended CBL6PS (CBL8PS fixed at 80 m)	20 m	12
	40 m	10
	60 m	8
	80 m	7
Extended the 1 st CBL8PS cable to HCS-8685 (CBL6PS fixed at 80 m)	20 m	9
	40 m	8
	60 m	8
	80 m	8

- **HCS-5100M/A series connect to HCS - 8685 translation unit via HCS-8300MES+HCS-4843T**

When HCS-5100M/A series transmitter works under mode 'Master- Interp. U', it can be connected to HCS-8300MES extension main unit, which can power for HCS-4385T cable splitter, and HCS-8685 interpreter units can be connect to HCS-4385T. Please note that the sum of the total power consumption of all the interpreter units connected ,plus the power loss in the extension cables does not surpass the power limit of the power consumption of HCS-8300MES. Otherwise the system will not work properly or automatic protection will occur (see table 3.3).

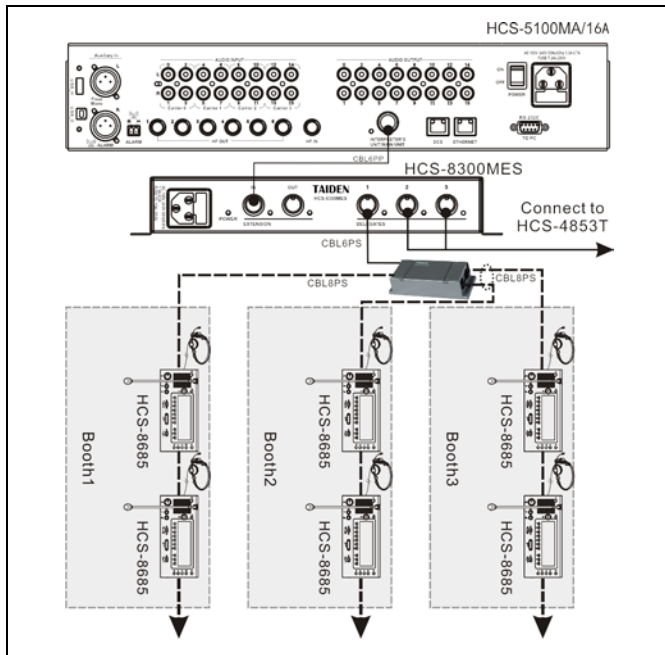

Figure 3.10 HCS-5100M/A connected to HCS-8685 via HCS-8300MES

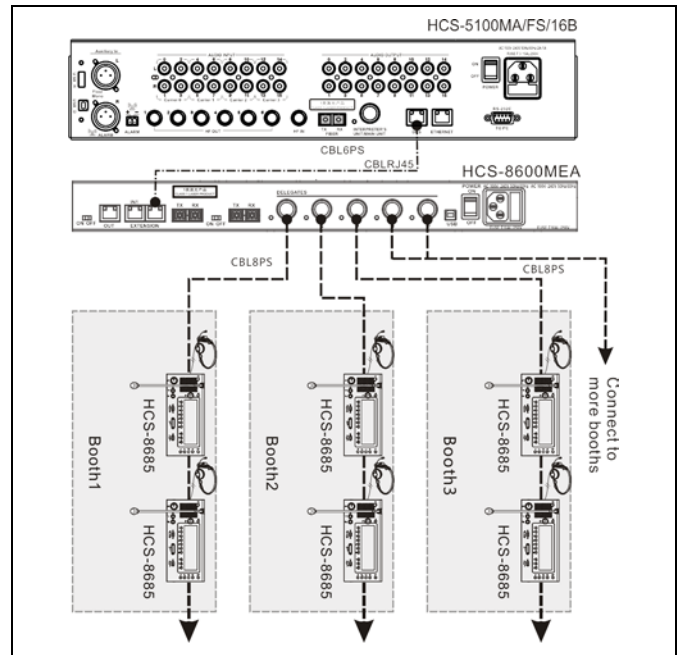

Figure 3.11 HCS-5100M/B connected to HCS-8685 via HCS-8600MEA

Table 3.3 Quick lookup table for the max. number of HCS-8685 interpreter units connect to HCS-5100M/A via HCS-8300MES (unit: pcs)

Scenarios	Extension cable Length	The max. number of 8685 interpreter units per port
Extend CBL8PS cable length to the first HCS-8685	20 m	7
	40 m	7
	60 m	6
	80 m	6

Table 3.3 Quick lookup table for the max. number of HCS-8685 interpreter units connect to HCS-5100M/B via HCS-8600MEA (unit: pcs)

Scenarios	Extension cable Length	The max. number of 8685 interpreter units per port
Extend CBL8PS cable length to the first HCS-8685	20 m	9
	40 m	8
	60 m	7
	80 m	7

● **HCS-5100M/B series connect more HCS - 8685 translation unit via HCS-8600MEA**

The DCS interface of the HCS-5100M/B series digital infrared transmitter can be connected to HCS-8600MEA extension main unit, which can connect a larger number of HCS-8685 translation units. Please note that the sum of the total power consumption of all the interpreter units, plus the power loss in the extension cables does not surpass the power limit of HCS-8600MEA (see table 3.2).

3.4.5 To HCS-4100/50, HCS-4800, HCS-8300, HCS-8600 Congress System

■ **HCS-5100MA/A, HCS-5100MA/B connected to HCS-8300 Paperless Multi-media Congress System**

HCS-4100M/ HCS-8300M/ HCS-4800M/ HCS-8600M congress main unit can be connected via fiber interface of HCS-5100MA/FS/A and HCS-5100MA/FS/B, or 6P-DIN / DCS interface of HCS-5100MA/A and HCS-5100MA/B, and 4, 8 or 16 channels audio output can be used for audio recording (see figure 3.12, 3.13).

■ **HCS-5100MC/A, HCS-5100MC/B connected to Congress System**

HCS-5100MC/A transmitter can be connected to TAIDEN HCS-8300M congress main unit through TAIDEN HCS-8300MO audio output device. While HCS-5100MC/B transmitter can be connected to HCS-8600M congress unit by bridging via HCS-8600MIO audio input & output device. The output of HCS-8300MO or HCS-8600MIO should be connected to the audio input of transmitter one-to-one correspondingly through audio cable (see figure 3.14, 3.15).

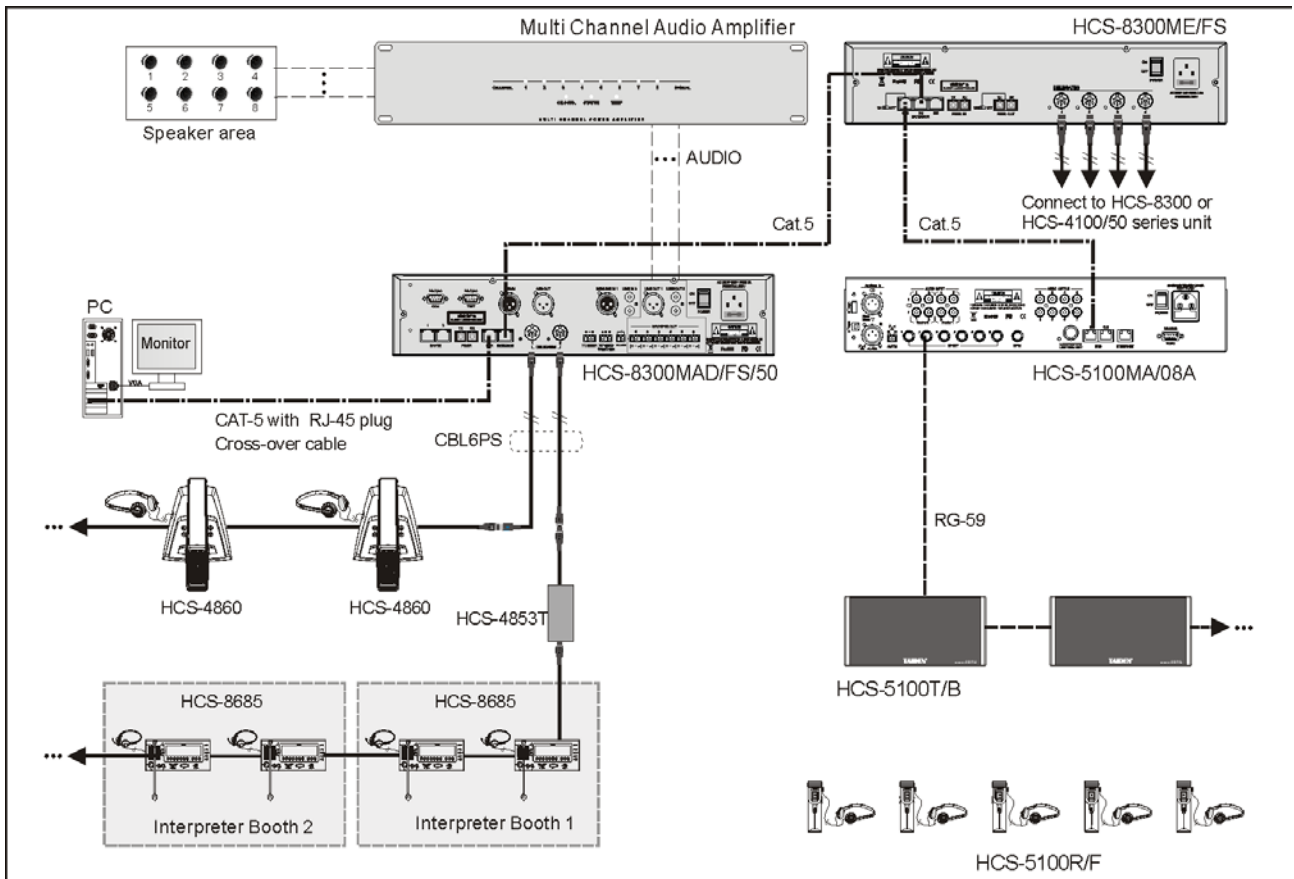

Figure 3.12 HCS-5100MA/A transmitter connecting to HCS-8300M congress main unit

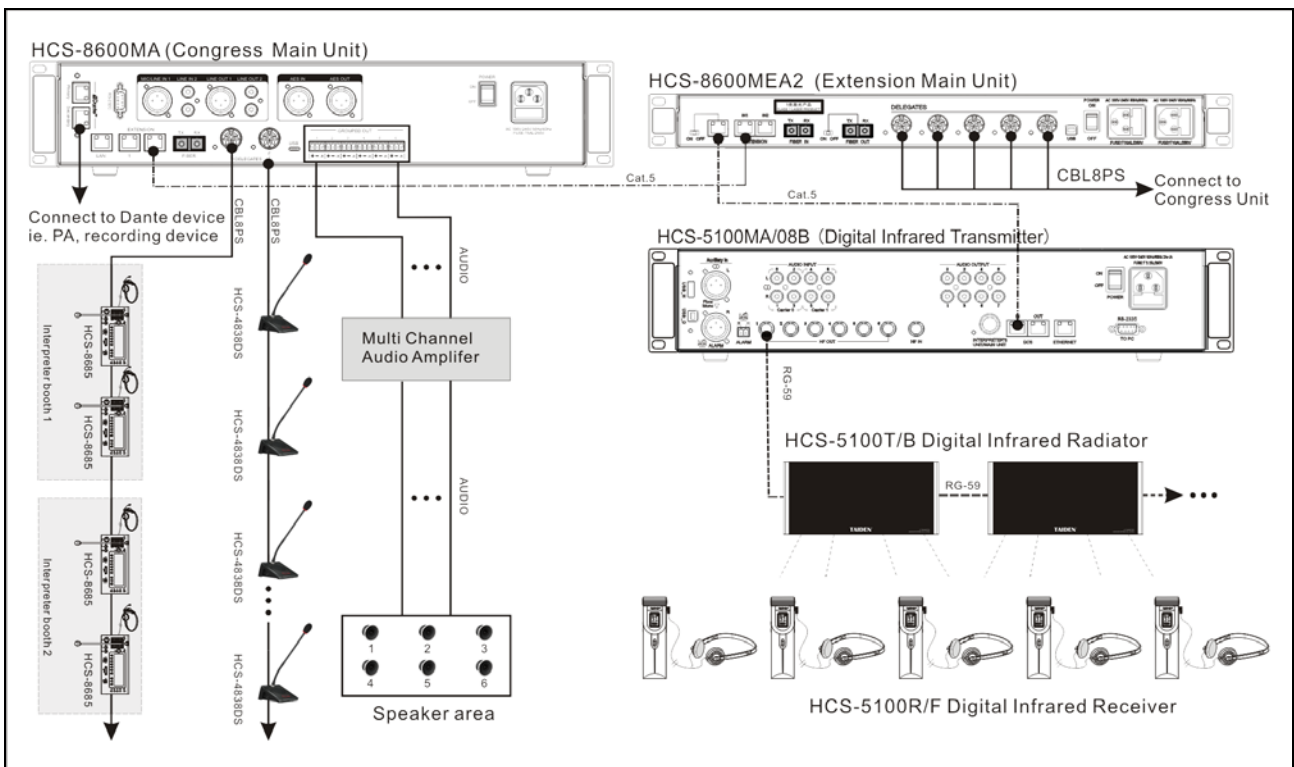

Figure 3.13 HCS-5100MA/B transmitter connecting to HCS-8600M congress main unit

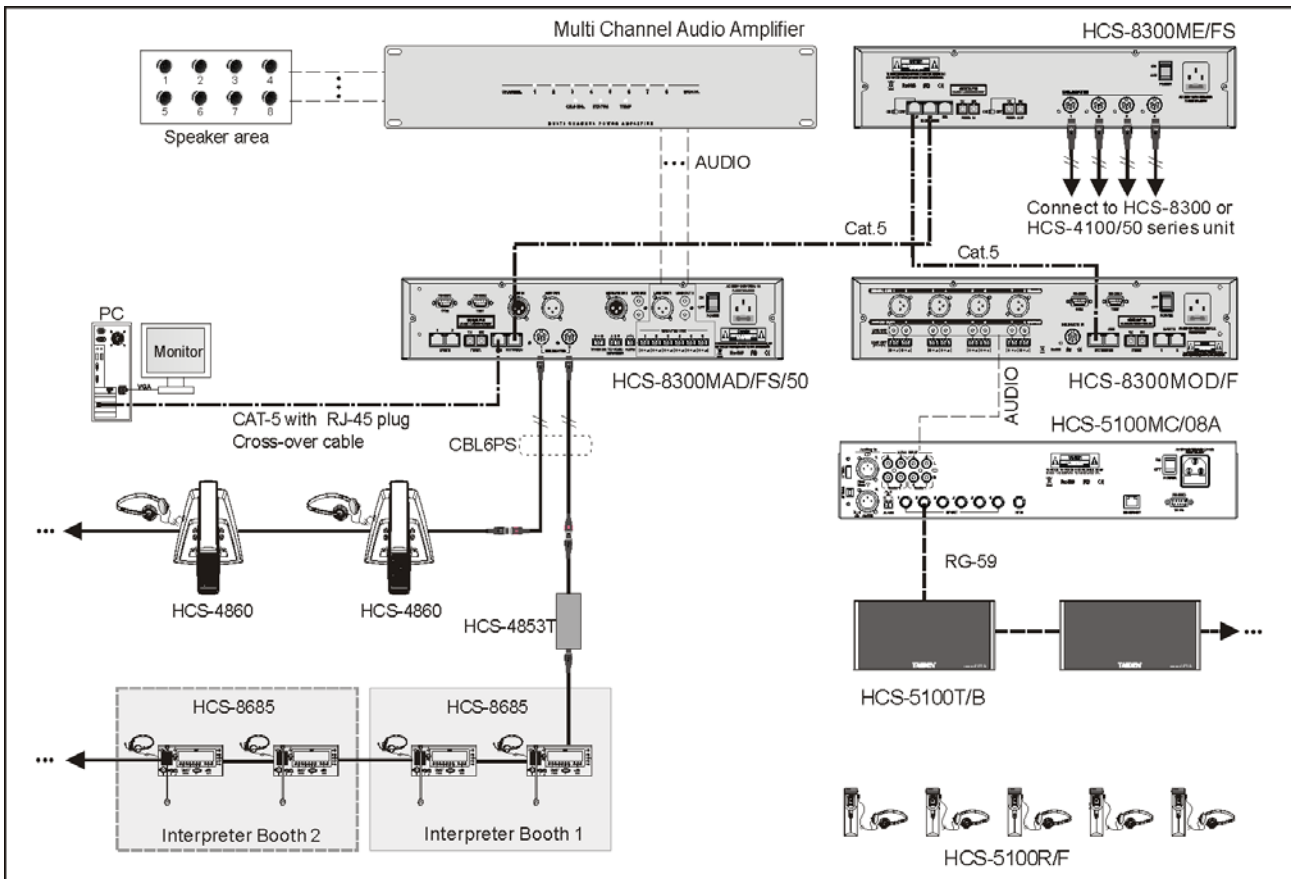

Figure 3.14 HCS-5100MC/B transmitter connecting to HCS-8300M congress main unit through HCS-8300MO

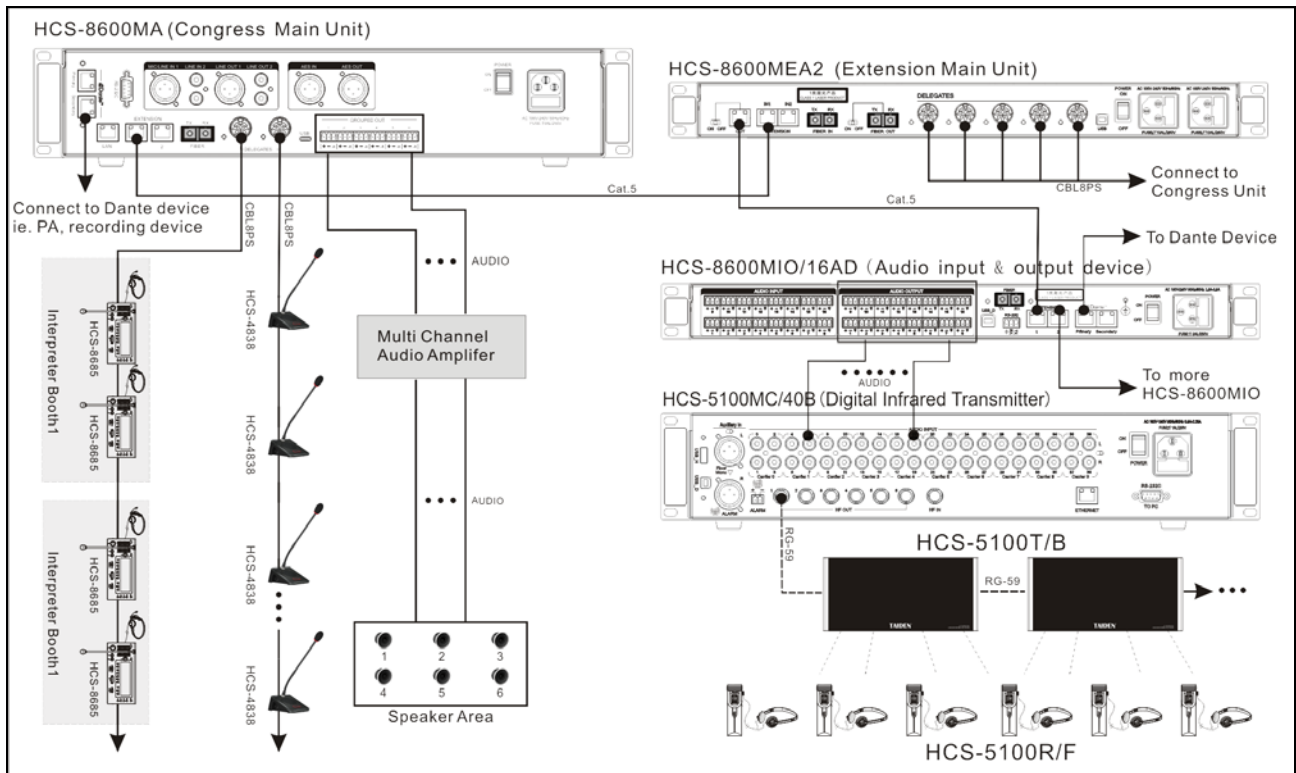

Figure 3.15 HCS-5100MC/B transmitter connecting to HCS-8600M congress main unit through HCS-8600MIO

3.5 Menu structure

3.5.1 Transmitter menu structure (work mode: Master-Analog)

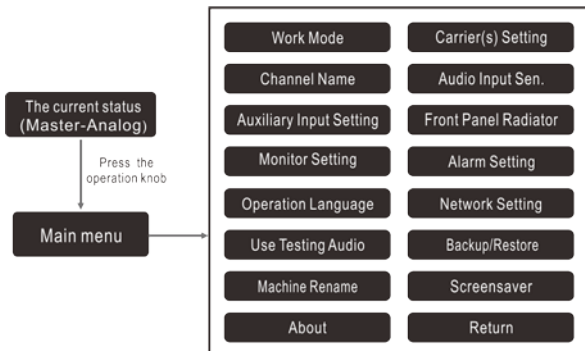

Figure 3.16a Transmitter menu structure (work mode: Master-Analog)

3.5.3 Transmitter menu structure (work mode: Master-Central U)

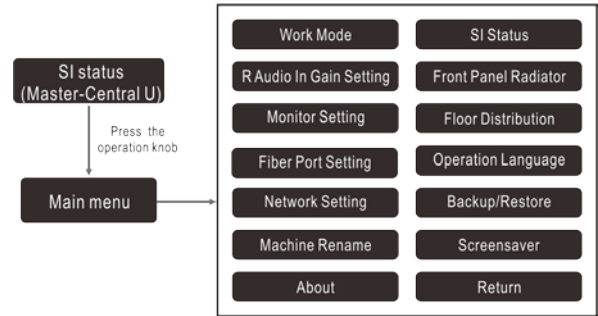

Figure 3.16c Transmitter menu structure (work mode: Master-Central U)

3.5.2 Transmitter menu structure (work mode: Master-Interp. U)

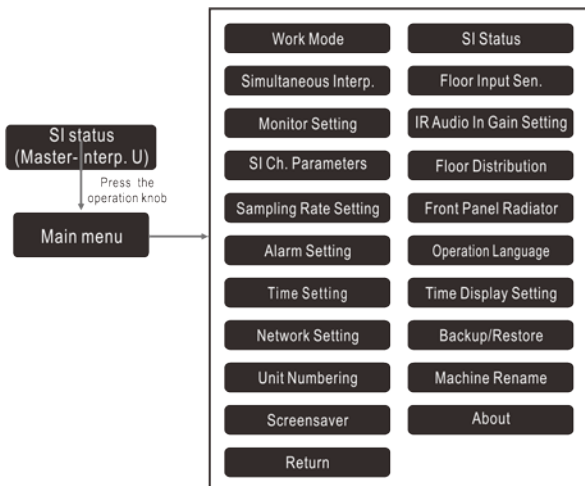

Figure 3.16b Transmitter menu structure (work mode: Master-Interp. U)

3.5.4 Transmitter menu structure (work mode: Master-Dante)

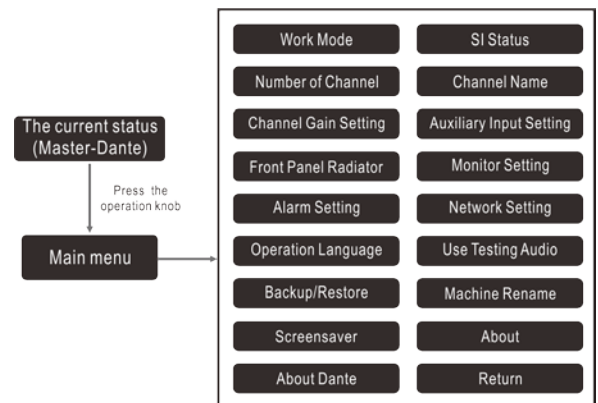

Figure 3.16d Transmitter menu structure (work mode: Master-Dante)

3.5.5 Transmitter menu structure (work mode: Bypass)

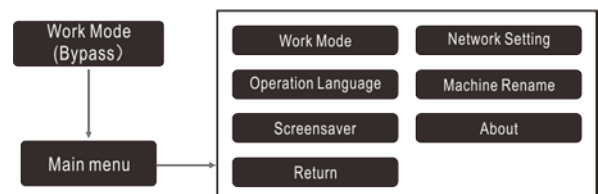

Figure 3.16e Transmitter menu structure (work mode: Bypass)

3.6 Configuration and operation

Via an interactive menu on the LCD and the operation knob.

A) Starting initialization:

Switch on and press the standby key, the HCS-5100M/A digital infrared wireless conference system main unit will start initialization:



Under the initial interface, there are parameters such as work mode, total channels, monitor channel, audio source and IP address.

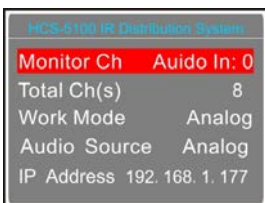

B) Accessing “Main” menu:

Press the operation knob. Depending on the transmitter work mode, the LCD display shows the terms:

In “**Master - Analog**” mode:

- “Work Mode Setting”
- “Carrier(s) Setting”
- “Channel Name”
- “Audio Input Sen.”
- “Auxiliary Input Setting”
- “Front Panel Radiator”
- “Monitor Setting”
- “Alarm Setting”
- “Operation Language”
- “Network Setting”
- “Use Testing Audio”
- “Backup/Restore”
- “Machine Rename”
- “Screensaver”
- “About”
- “Return”

In “**Master - Interp. U**” mode:

- “Work Mode Setting”
- “SI Status”
- “Simultaneous Interp.”
- “Floor Input Sen.”
- “Monitor Setting”
- “SI Ch. Parameters”
- “Floor Distribution”
- “Front Panel Radiator”
- “Alarm Setting”
- “Operation Language”
- “Select sampling rate of system”
- “Time Setting”
- “Time Display Setting”
- “Network Setting”
- “Backup/Restore”
- “Unit Numbering”
- “Machine Rename”
- “Screensaver”
- “About”
- “Return”

In “**Master - Central U**” mode:

- “Work Mode Setting”
- “SI Status”
- “Front Panel Radiator”
- “Monitor Setting”
- “Floor Distribution”
- “Fiber Port Setting”
- “Operation Language”
- “Network Setting”
- “Backup/Restore”
- “Machine Rename”
- “Screensaver”
- “About”
- “Return”

In “**Master - Dante**” mode:

- “Work Mode Setting”
- “SI Status”
- “Number Of Channel”
- “Channel Name”
- “Channel Gain Setting”
- “Auxiliary Input Setting”
- “Front Panel Radiator”
- “Monitor Setting”

- “Alarm Setting”
- “Network Setting”
- “Operation Language”
- “Use Testing Audio”
- “Backup/Restore”
- “Machine Rename”
- “Screensaver”
- “About”
- “About Dante”
- “Return”

In “Bypass” mode:

- “Work Mode Setting”
- “Network Setting”
- “Operation Language”
- “Machine Rename”
- “Screensaver”
- “About”
- “Return”

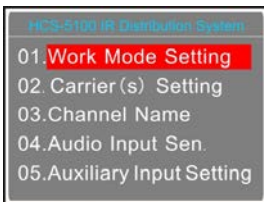

- Press the operation knob to go to the corresponding submenus, it will return to the initial interface when no operation in 90 seconds;
- To switch from term to rotate the operation knob.

3.6.1 Work Mode Setting

a) Rotate the operation knob to switch between “Master” and “Bypass”;

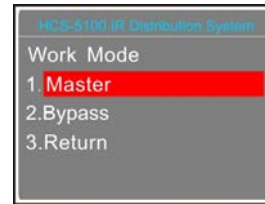

- “Master”, Press the operation knob to confirm and go to step b);
- “Bypass”, Press the operation knob to confirm and go to step c);
- “Return”, press the operation knob to the upper level menu;

b) Rotate the operation knob to select the master mode interface;

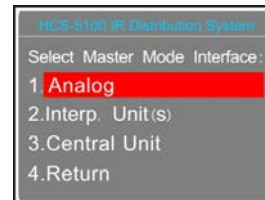

- “Analog”, SI audio signal input from AUDIO IN interfaces of transmitter;
- “Interp. U”, SI audio signal input from Interpreter unit(s) connected to the transmitter;
- “Central U”, SI audio signal input from main unit(s) connected to the transmitter;
- “Dante”, SI audio signal input from Dante network connected to the transmitter;
- “Return”, press the operation knob to the upper level menu;

c). Transmitter needs to restart to implement working mode configuration. Rotate the operation knob to select reset now or not.

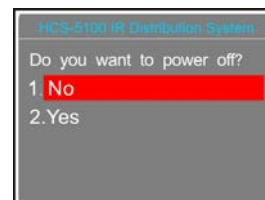

Note:

☞ Please reboot the Digital Infrared Transmitter to enable setting.

3.6.2 Carrier(s) Setting

Users can set the status of every carrier, the number of channels and the audio quality.

1) Set up status

Enable/disable current carrier.

Rotate the operation knob to enable or disable the current carrier and press it to save;



- **“Enabled”**: Press operation knob to go to step 2);
- **“Disabled”**: Press operation knob to return to the upper level menu.

2) Carrier frequency setting

a) Rotate the operation knob to select a frequency.

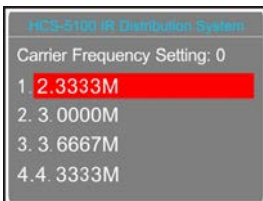

b) Press operation knob to save.

3) Channel number

a) Rotate the operation knob to select the channel number. The exact channel number depends on the audio quality.

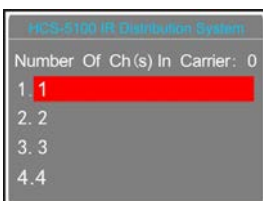

b) Press the operation knob to save.

4) Audio quality

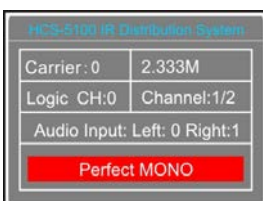

b) Rotate the operation knob to switch channel number (in the case of more than one channel).

“Audio input:” indicates the current channel corresponding to the HCS-5100M transmitter audio input channel;

c) After having selected channel number(s), rotate the operation knob to adjust audio quality.

- Audio mode includes:**
- “Standard MONO”
 - “Perfect MONO”
 - “Standard STEREO”
 - “Perfect STEREO”

The selectable audio quality depends on the channel number (refer to section [1.2.5](#)).

5) Save settings

- Press the operation knob to save setting;
- Go to the next carrier configuration;
- Repeat above until all carriers have been set up.

3.6.3 Channel Name

Assign a language name for every channel.

- Rotate the operation knob to adjust the current channel name and then press the operation knob into the next channel setting;
- Press the operation knob to save after setting;
- Go to the next carrier configuration;
- Repeat above until all carriers have been set up.



3.6.4 Audio Input Sen.

“Input sen.” includes below submenus:

- **“All”**: adjust all channels input sensitivity
- **“Per. Input”**: adjust each channel input sensitivity separately

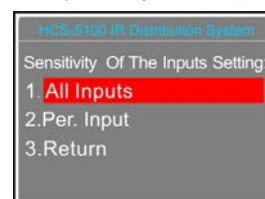

- **“All”:**

Rotate the operation knob to adjust the max. level for all audio inputs and then press the operation knob to save. Range from -12 dBV - +12 dBV.



- **“Per Input”:**

- Rotate the operation knob to adjust the max. level for current audio input. Range from -12 dBV - +12 dBV.
- Press the operation knob to save and go to the next channel;
- Repeat above until all channels have been set up.



3.6.5 Auxiliary Input Setting

“Auxiliary Input Setting” includes below submenus:

- “Aux. Input Type”
- “Sensitivity”
- “Play Music”

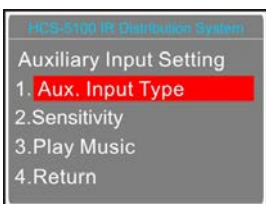

- **“Aux. Input Type”**

Rotate the operation knob to select the auxiliary input type between “Stereo Music” and “Mono + Emergency”. Press the operation knob to save and return to the level menu.

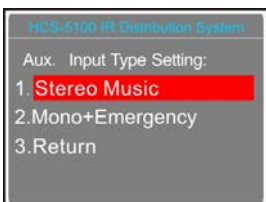

“Stereo Music”:

If “Play music”, stereo music from 2 channels

auxiliary audio input will be distributed to all output channels, usually for playing music when adjournment.

- **“Mono + Emergency”:**

Once the alarm signal is turned on, the emergency signal from Aux-R audio input will be distributed to all output channels on the premise that fire alarm linked trigger interface is closed.

- **“Sen. (sensitivity)”**

Rotate the operation knob to adjust the auxiliary input level, range from -6 dBV - +18 dBV. Press the operation knob to save and return to the level menu.



- **“Play Music”**

- If “Aux input type” is “Stereo music”, stereo or mono music from the auxiliary audio input will be distributed to all output channels. “MUSIC” will be displayed at this moment;
- Press the operation knob to stop and exit.



3.6.6 Front Panel Radiator

Enable/disable the front panel radiator. If “Enable”, the infrared signal can be monitored or tested via the front panel radiator.

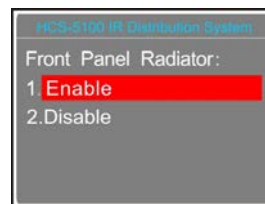

- Rotate the operation knob to select enable or disable the front panel radiator;
- Press the operation to save and return to the upper level menu.

3.6.7 Monitor Setting

The front panel has a monitor earphone jack for testing the transmitter.

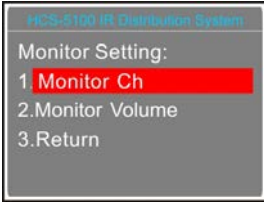

- **“Monitor Ch”:**

Rotate the operation knob to select the monitor channel, then press the operation knob to save and return to the level menu.

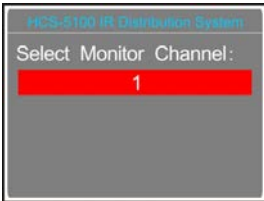

- **“Monitor Volume”:**

- Rotate the operation knob to adjust the monitor volume, range: -30 dBV - 0 dBV;
- Press the operation knob to save and return to the level menu.

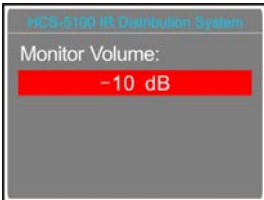

Note:

☞ Monitor value will return to default (CH: 0, monitor volume: -10 dB) when reboot.

3.6.8 Alarm Setting

Enable alarm function or not.

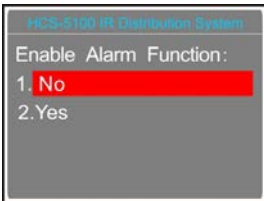

- Rotate the operation knob to select “Yes” or “No”;
- Press the operation knob to save and return to the level menu.

3.6.9 Operation Language

Select the LCD display language from simplified Chinese, Traditional Chinese, English, etc. Other languages can be added by the user through LCD_Designer software operation.



- Rotate the operation knob to select the LCD display language;
- Press the operation knob to save and return to the level menu.

3.6.10 Network Setting

“Network” includes three submenus:

- “IP Address”
- “Subnet Mask”
- “Gateway”

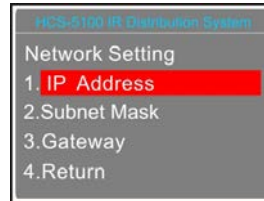

1) Setting up unique “IP Address” for the transmitter:



- Rotate the operation knob to switch between the four numbers;
- Press the operation knob to edit the selected number;
- Rotate the operation knob to decrease/increase the number;
- Rotate the operation knob to “Return” and press the operation knob to save and return the upper level menu.

2) Setting up “Subnet Mask” and “Gateway”:

Same chronological order as for the “IP address” set up.

Note:

- ☞ “IP address”, “Subnet Mask” and “Gateway” of the system software should correspond with the above transmitter settings, else connection error will occur.

3.6.11 Use Testing Audio

The transmitter goes to testing mode and testing tone will be distributed to all output channels.

Press the operation knob to stop the testing mode.



3.6.12 Backup/Restore

System parameters can be backed up or restored through the panel USB port. Make sure that the USB disk is properly connected; otherwise it will prompt “Please insert the USB disk.”



- Rotate the operation knob to select “Backup” or “Restore”;
 - If “Backup” is selected, system parameters can be backed up;
 - If “Restore” is selected, system parameters can be restored;
- Press the operation knob to confirm and to go to selected menu item;
- Return to upper level menu after backup and reboot after recovery.

3.6.13 Machine Rename

Set alias for the HCS-5100M with a maximum length of 16 characters or less.



Rotate the operation knob to move the cursor, then press the knob to modify the character; turn the knob to left to clear all characters after cursor, and turn the knob to right to select the new characters. Press the knob to save at each character. Select “Return” to the upper level menu after setting finished.

3.6.14 Screensaver

The main unit will enter screensaver status if no operation in 3 minutes when enable.

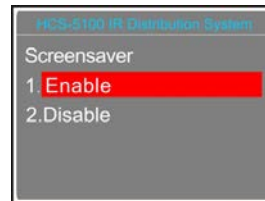

- Rotate the operation knob to select “Enable” or “Disable”;
- Press the operation knob to save and return to the level menu.

3.6.15 About

Transmitter firmware information will be displayed, including: version, main unit information and product series number. Press the operation knob to return to the upper level menu.



3.6.16 SI Status

When the HCS-5100MA/A transmitter is connected to the simultaneous interpretation unit via the 6P-DIN interface, the simultaneous interpretation status will be displayed on the LCD (F: floor channel, +: SI channel used, ×: no use). It once displays 8 channel status, rotate the operation knob to turn pages.

1	2	3	4	5	6	7	8
F	F	F	F	F	X	F	F
00 FLO	01 ZHO	02 ENG	03 LAO	04 HIN	05 BOO	06 TUK	07 VIE

3.6.17 Simultaneous Interp.

In “Simultaneous Interp.” submenu, the following parameters need to be setup:

- ◆ “Select Number of Channel(s):”
- ◆ “Select Language for Channel:”
- ◆ “Select Number of Booth(s):”
- ◆ “Set Interlock Mode Between Booths:”
- ◆ “Interlock Mode in a Booth Setting”
- ◆ “Set Switch Outgoing Channel When Mic. On”
- ◆ “Select Language of Output Channel for Booth:”
- ◆ “Auto-Relay Booth Setting”

Operation steps:

a). Setup the number of interpretation channels



Rotate the operation knob to switch the number of interpretation channels:

- If “0” is selected, it stands for no SI function, press the operation knob to save and return to the main menu;
- If other values are selected, it stands for the number of interpretation channels, press the operation number to go to step b).

b). Setup language for channel



- 1). Setup channels 1 first, rotate the operation knob to switch among languages;
- 2). Press the knob to confirm the selected language and go to the next channel;
- 3). Repeat 1) - 2) to set up the language for all channels, and go to step c);

c). Select number of booths

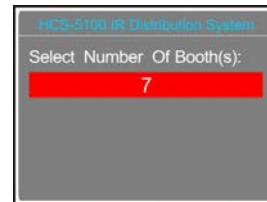

Rotate the operation knob to switch the number of booths. Usually, one language will take one booth.

- If “0” is selected, it stands for no SI function, press the knob to save and return to the main menu;
- If other values are selected, it stands for the number of interpretation booths, press the knob to go to step d).

d). Set interlock mode between booths

Select interlock mode between booths, includes:

- “INTERLOCK”
- “OVERRIDE”
- “OVERRIDE-BC”
- “Return”

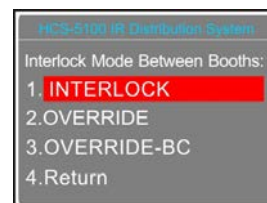

- 1). Rotate the operation knob to switch among the interlock modes;
 - “INTERLOCK” mode prevents that two booths engage the same channel.
 - “OVERRIDE” mode enables an interpreter unit in another booth to override an occupied channel in another booth, but supplying the same channel.

- “OVERRIDE-BC” mode enables A/B/C channel of an interpreter unit in another booth to override an occupied B/C channel in another booth, but supplying the same channel; when an interpreter unit in another booth to override an occupied A channel in another booth, the “Microphone ON” indicators the occupied A channel will flash on the control panel for about 5 seconds.

- 2). Press the operation knob to confirm selected interlock mode and go to step e).

e). Set interlock mode in a booth

Select interlock mode in a booth, includes:

"INTERLOCK"

"OVERRIDE"

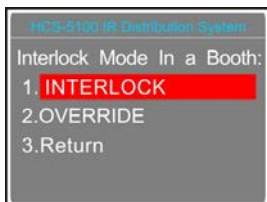

- 1). Rotate the operation knob to switch between interlock modes;
 - “INTERLOCK” mode prevents that two interpreter units in a booth engage the same channel.
 - “OVERRIDE” mode enables an interpreter unit to override an occupied channel in the same booth, but supplying the same channel.
- 2). Press the operation knob to confirm selected interlock mode and go to step f).

f). Set switch outgoing channel When mic. on

Set switch outgoing channel when microphone on for HCS-8385.

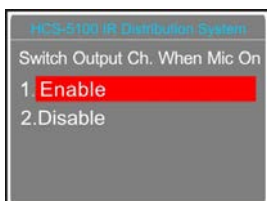

- 1). Rotate the operation knob to switch between “Enable” and “Disable”,
- 2). Press the operation knob to confirm and go to step g)

g). Select language of output channel for the booth

To distribute the interpretation languages separately, A/B/C channels are provided in each interpretation unit. The language setting of A/B/C channels for all interpreter units in one booth is uniform. After the setup of booth numbers, the user interface to set up output the channel A/B/C language will be shown for each booth.

- 1). Setup channel A language for booth 1: rotate the operation knob to select the language from those languages that have been selected in step b) and press the knob to confirm;

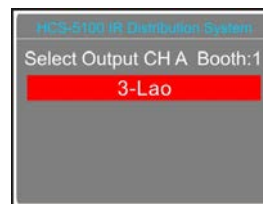

- 2). Select channel C language for booth 1: “None” or “All”;

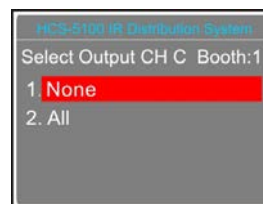

- If “All” is selected for C then rotate the operation knob to select the language for B from those languages that have been selected in step b) and press the knob to confirm;



- If “None” is selected for C then select channel B language from “None” or “All”;

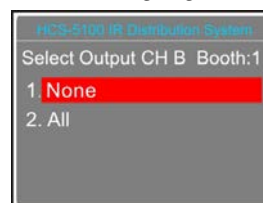

- ♦ “None” stands for no language output from channel B;
- ♦ “All” stands for the language of channel B which can be any of the selected languages.

Press the operation knob to confirm and go to configuration for next booth;

- 3). Repeat 1) - 2) to setup output channel A/B/C language for all booths;
- 4). Press the operation knob to confirm selected interlock mode and go to step h).

h). Auto-Relay booth Setting

Setup Auto-Relay booth.

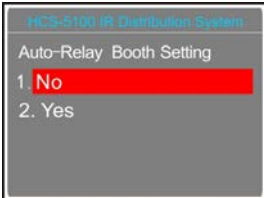

- 1). Rotate the operation knob to select yes or no
 - If select “No”, press the knob to confirm;
 - If select “Yes”, press the knob to confirm and go to next step;

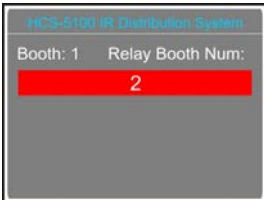

- 2). Rotate the operation knob to select auto-relay booth number and press the knob to go to the next step;



- 3). Rotate the operation knob to select auto-relay booth and press the knob to confirm, then the corresponding booth number will be highlighted and set as auto-relay booth, press the knob again to cancel the setting.
- 4). Rotate the operation knob to select next auto-relay booth until all auto-relay booths have been set.

Note:

☞ If channel B and C of a booth have no output, this booth can not be set as auto-relay booth.

3.6.18 Floor Input Sensitivity

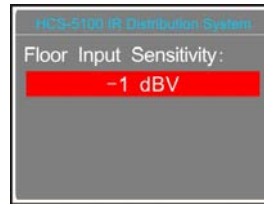

- a). Rotate the operation knob to adjust the floor input sensitivity, range from -6 dBV - +18 dBV;
- b). Press the knob to save and return to the upper level menu.

3.6.19 SI Ch. Parameters

Monitor the language channels and set up their states. Press the operation knob then rotate it to view the channel state. If a channel has not been fed with language output temporarily, the LCD displays as in the following figure:



If the microphone of the Interpreter unit in the booth is active, the audio parameters of the Interpreter unit will be displayed as in the following figure and can be adjusted:

HCS-5100 IR Distribution System			
Channel	3		
Booth	Gain	LowCut	
1	+3 dB	ON	
LowFreq	MidFreq	HighFreq	
0 dB	0 dB	0 dB	

Under channel state interface, rotate the operation knob to select the channel number or parameter and press it to change the channel number or parameter.

3.6.20 Floor Distribution

Enable/disable switch to floor channel automatically when no interpretation channel is available.

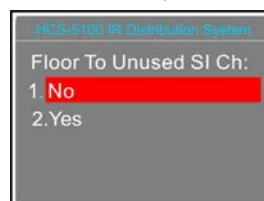

- a). rotate the operation knob to select “Yes” or “No”;

- b). Press the operation knob to save and return to the upper level menu.

3.6.21 Sampling Rate Setting

Select sampling rate of the system according to the interpreter unit connected

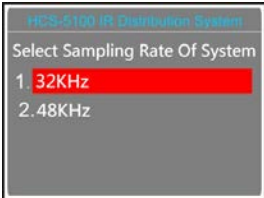

- a). Rotate the operation knob to select “32KHz” or “48KHz”;
 b). Press the knob to save and return to the upper level menu.

3.6.22 Time Setting

Setup system clock.



- a). Rotate the operation knob to go to "Year", "Month", "Day", "Hour", "Minute" in turn;
 b). Press the knob and then rotate it to set time;
 c). Press the knob to save;
 d). Rotate the knob to “Return” and press the knob to the upper level menu.

3.6.23 Time Display Setting



- a). Rotate the operation knob to select “Yes” or “No”;
 b). Press the knob to save and return to the upper level menu.

3.6.24 Unit Numbering

All HCS-4385U/50 interpreter units must be numbered

when the system is used for first time or when adding or replacing interpreter units.

- a). Press the operation knob to enter numbering starts, the indicating light “B” of all connected interpreter units will be on and the CMU LCD will display as follow:

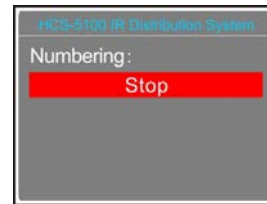

- b). Rotate the primary knob on the interpreter unit to select the number (rang: 1-6), and press key “B” to confirm;
 c). Press the operation knob to stop number and return to the upper level menu.

3.6.25 Fiber Port Setting

Enable/disable the fiber port.

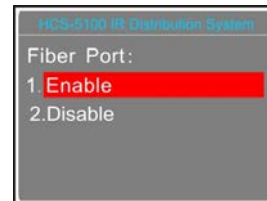

- a). Rotate the operation knob to select “Enable” or “Disable”;
 b). Press the knob to save and return to the upper level menu.

3.6.26 Number of Channel



- a). Rotate the operation knob to set number of audio input channel, rang: 0-16;
 b). Press the knob to save and return to the upper level menu.

3.6.27 Channel Gain Setting

“Input sensitivity” includes following submenus:

- “All”: adjust all channels input gain

- **“Per. Input”**: adjust each channel input gain

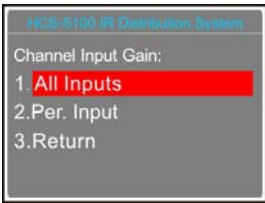

- **“All”**:

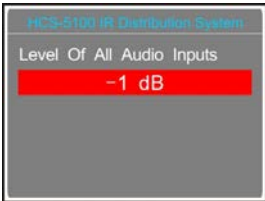

Rotate the operation knob to adjust the gain for all audio inputs. Range from -12 dB - +12 dB.

- **“Per Input”**:



- a) Press the operation knob to switch channel number;
- b) Rotate the operation knob to adjust the gain for each audio input. Range from -12 dBV - +12 dBV.

3.6.28 About Dante

Dante software information will be displayed, including: Dante version, device version and device name. Press the operation knob to return to the upper level menu.

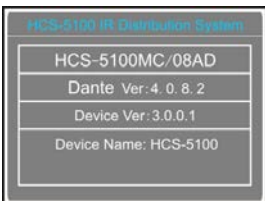

Chapter 4. Digital Infrared Radiator

4.1 Overview

This unit accepts carrier signals generated by the transmitter and emits infrared radiation, carrying up to 40 audio distribution channels. Radiators are connected to the HF (BNC) connectors of the IR transmitter. A maximum of 30 radiators, daisy chained connected, can be connected to each of these outputs.

HCS-5100T/B Series Radiator has longer cover area that can be up to 100 meters and will power on/off synchronously with the transmitter automatically.

If the radiator does not receive a carrier, it switches to stand-by state automatically. If the radiator is overheating, it will automatically switch from full power to half power, or from half power to stand-by state.

Types:

■ Digital Infrared Radiator

HCS-5100T/15B

15W Digital Infrared Radiator (delay compensation function, 75 Ω , switching mode power supply, without fan)

HCS-5100T/25B

25W Digital Infrared Radiator (delay compensation function, 75 Ω , switching mode power supply, without fan)

HCS-5100T/35B

35W Digital Infrared Radiator (delay compensation function, 75 Ω , switching mode power supply, without fan)

4.2 Functions and indications

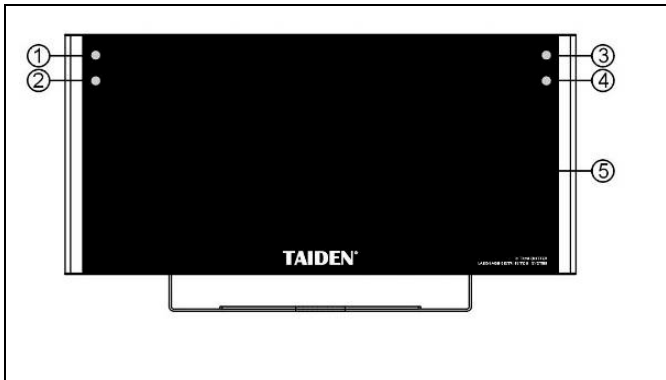

Figure 4.1 Radiator (front)

Figure 4.1:

1. Power indicator
2. Temperature protection indicator
3. Input signal indicator
4. Fault indicator
5. Infrared emission area

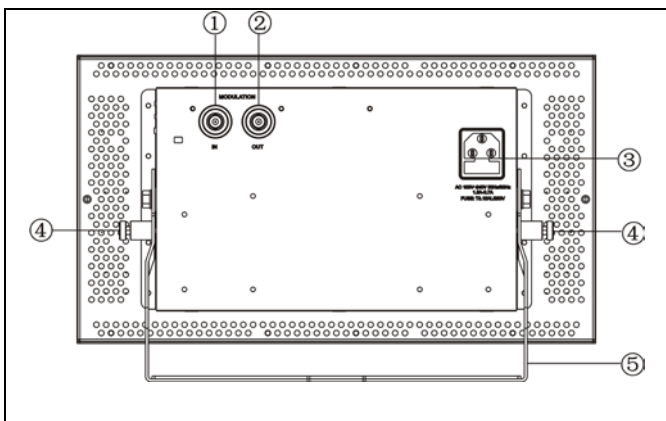

Figure 4.2 Radiator (rear)

Figure 4.2:

1. Signal input
2. Synchronous output interface
3. Power supply
4. Angle adjust handle (180°/13 gear)
5. Bracket

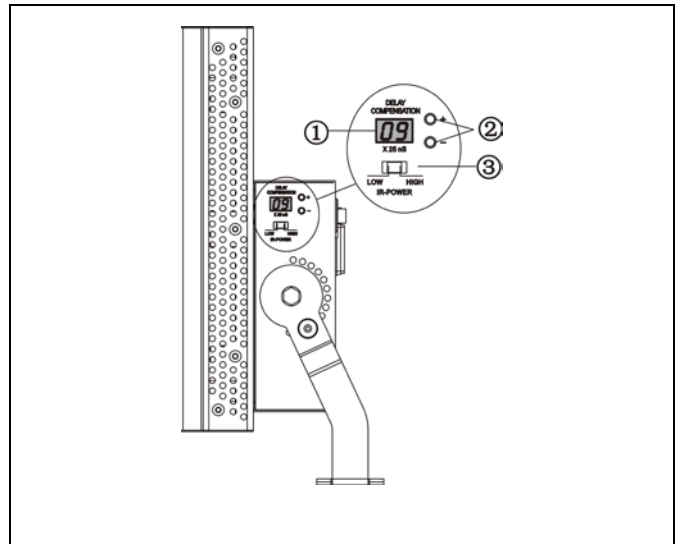

Figure 4.3 Radiator (side face)

Figure 4.3:

1. Delay compensation indicator
2. Delay compensation switch (-/+)
3. Output power switch

4.3 Position scheme

For position scheme, please read section [1.3](#) to understand and consider every aspect of infrared distribution.

4.3.1 Rectangular footprints

The determination of the optimal number of infrared radiators needed to have complete coverage of a conference venue can only be done by performing an on-site test. However, estimation can be done by 'guaranteed rectangular footprints', see figure 4.4 and figure 4.5. The rectangular footprint is smaller than the actual footprint. Figure 4.5 shows a negative 'offset' X because the radiator is currently mounted beyond the horizontal point at which the rectangular footprint starts.

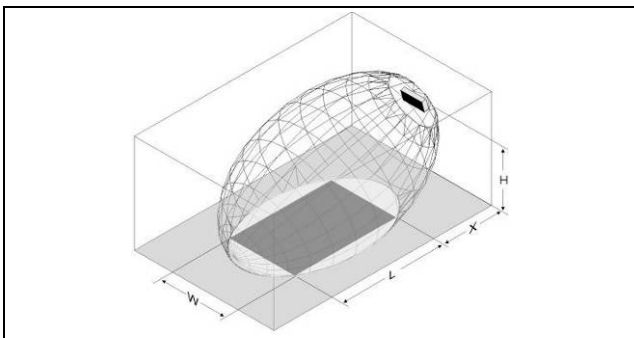

Figure 4.4 A typical rectangular footprint for a mounting angle of 15°

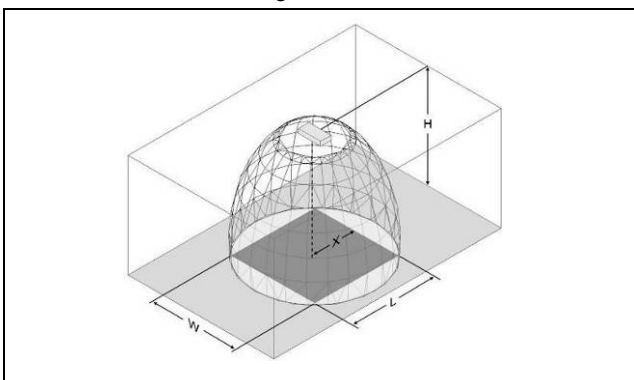

Figure 4.5 A typical rectangular footprint for a mounting angle of 90°

The guaranteed rectangular footprints of various numbers of carriers, mounting heights and mounting angles can be found in section [9.7](#). The mounting height is the distance to the radiator from the receiver reception level and not from the floor. Usually, the distance from the receiver reception level to the floor is 1 m approximately.

Guaranteed rectangular footprints can also be calculated with the footprint calculation tool (available on the documentation CD-ROM). The given values are for one radiator only, they do not take into consideration the beneficial effects of overlapping footprints and reflections (see section [1.3.6](#)).

For up to 4 carriers, experience shows that if the receiver can pick up the signal from adjacent radiators (presumed radiators at a distance W , their rectangular footprints just touching each other seamlessly) the distance W between these radiators can be increased by a factor 1.4 approximately (see figure 4.6).

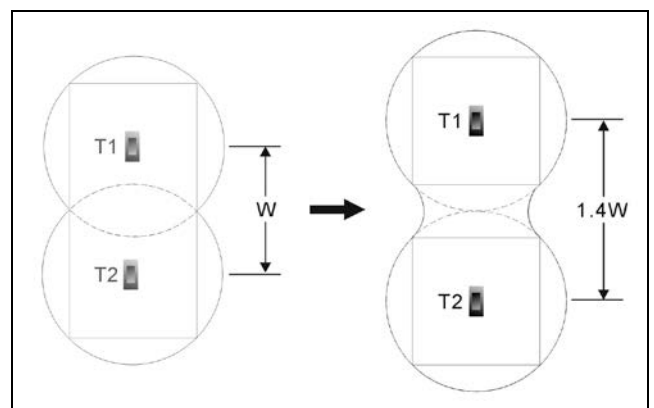

Figure 4.6 The effect of overlapping footprints

4.3.2 Planning radiators

Plan the radiators by following procedure:

1. Decide the positioning of the radiators by the recommendations in section [1.3](#).
2. Decide the applicable rectangular footprints by consulting the table or calculating with the footprint calculation tool.
3. Draw a picture of the rectangular footprints in the layout of the room.
4. If the receiver can pick up the signals from neighbored radiators in some areas (according to fig. 3.6) determine the overlapping effect and draw the picture of the footprint enlargement in the layout of the room.
5. Check whether there is sufficient coverage with the radiators at the intended positions.
6. If not, add additional radiators.

See figure 1.12 and figure 1.13 for examples of a radiator layout.

4.3.3 Cabling

Signal delay differences can occur because of the differences in the cable length from the transmitter to each radiator. In order to avoid the risk of blind area (see section 1.3.6), use equal cable length from transmitter to radiator if possible (see figure 4.7).

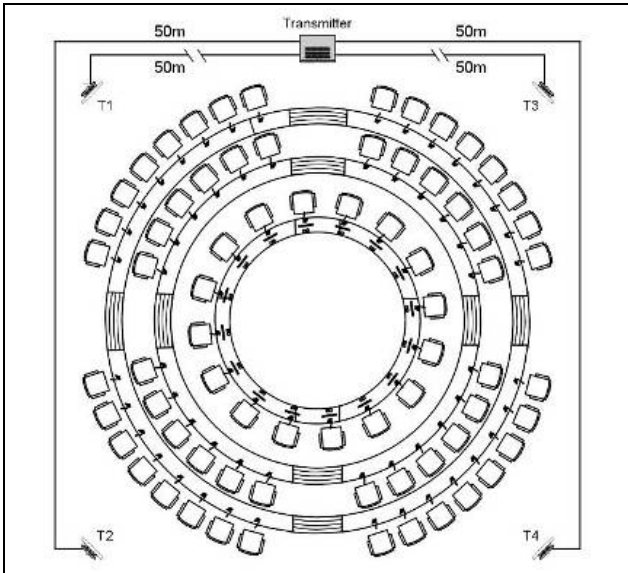

Figure 4.7 Radiators with equal cable length

If radiators are loop-through, the cabling between each radiator and the transmitter should be as symmetrical as possible (see figure 4.8). The differences in cable signal delays can be compensated with the signal delay compensation switches on the radiators.

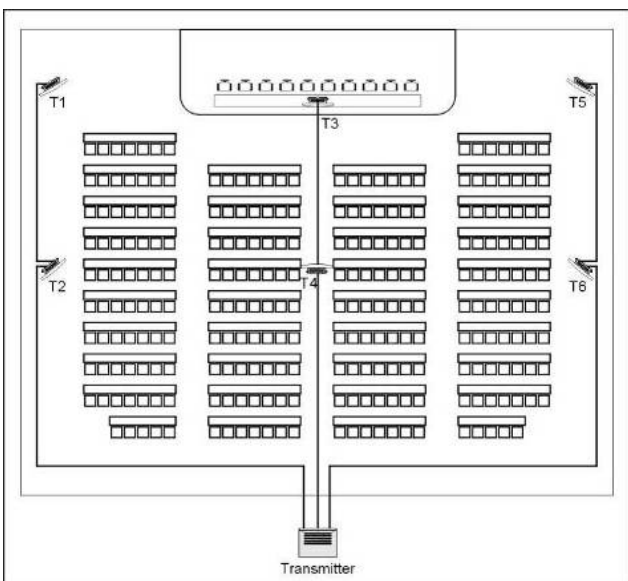

Figure 4.8 Symmetrical arrangement of radiator cabling

4.4 Mounting

The radiator can be permanently installed on the wall, under a ceiling or a balcony by bracket. The mounting angle can be adjusted for optimal coverage through angle adjust handle.

A separate bracket (HCS-5100TBZJ) is optional for wall mounting and a floor stand can be used for non-permanent installation.

Note:

- While installing and testing, the radiators may feel warm. It is normal and does not indicate a radiator fault or malfunction.

Warning:

- Always make sure that natural airflow is not obstructed by ceilings, walls etc. when determining the position of the radiator. Leave plenty of space around the radiator to prevent overheating.

4.4.1 Mounting on a floor stand

Fix the bracket of the radiator into the top of the floor stand with screw. The bracket is supplied with both metric and inch screw plate and is compatible with most stand floor tripods.

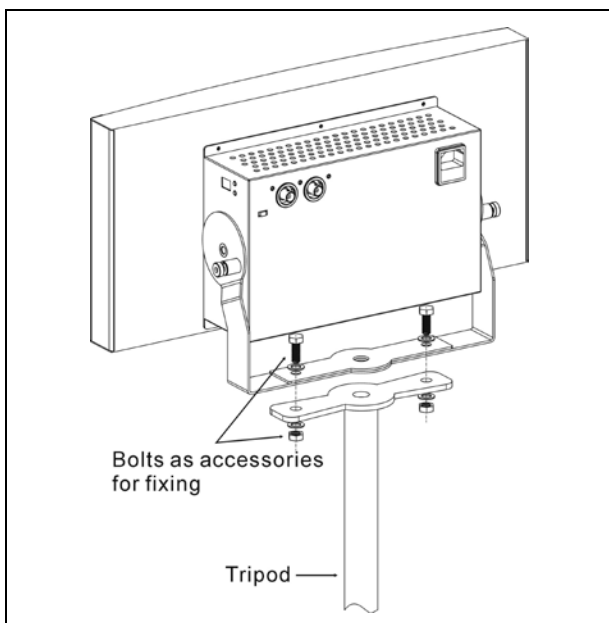

Figure 4.9 Mounting on a tripod

4.4.2 Wall mounting

A separate bracket (HCS-5100TBZJ) is optional for wall mounting (refer to figure 4.10). The bracket can be fixed onto the wall with 4 screws.

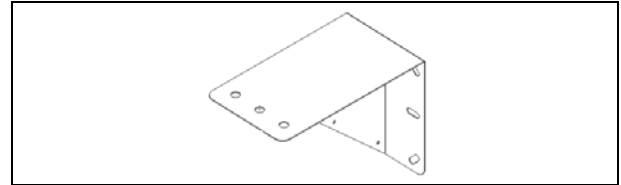

Figure 4.10 HCS-5100TBZJ bracket

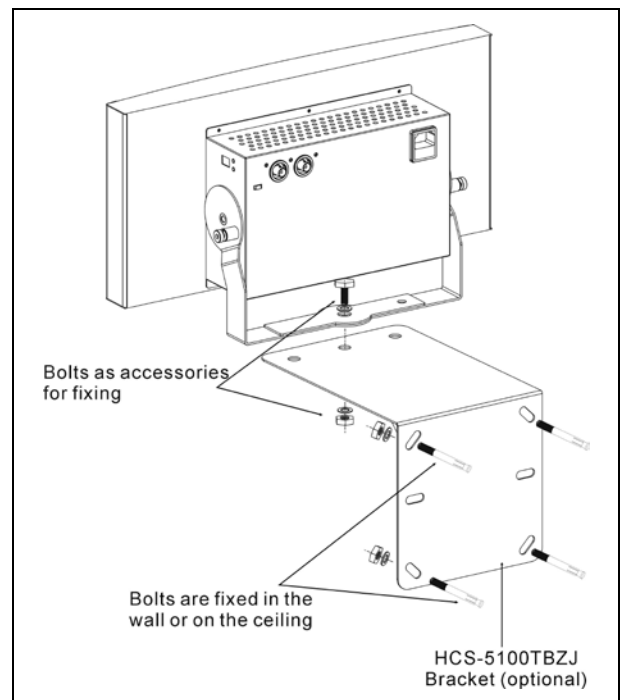

Figure 4.11 Wall mounting 1

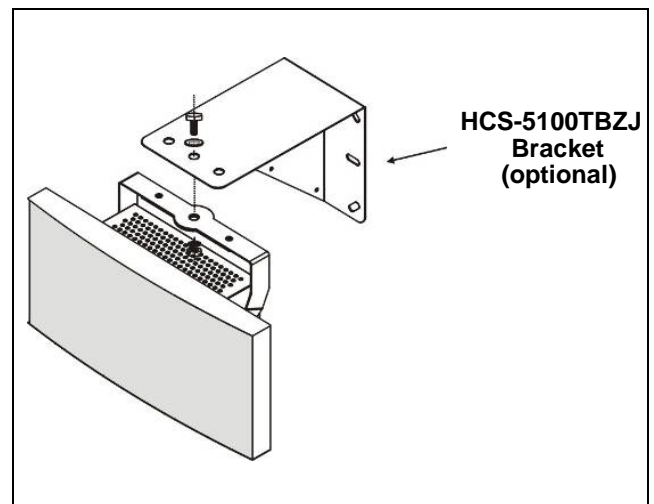

Figure 4.12 Wall mounting 2

Infrared radiator installing on a soft wall (such as plaster):

1. Reinforce the wall on both sides with a wood plate (about 500*500*10mm);
2. Drill holes into the wood plates and the wall according to the position of the fixing holes on the bracket;
3. Fix the wood plates on both sides of the wall with M3 screws; select screw bolts with suitable length (length > A);
4. Fix the bracket onto the wood plate and the wall with screw bolts;
5. Fix the radiator onto the bracket.

If the wall is too thick, use thicker wood plates to reinforce it. The best way to reinforce the wall is fixing the wood plate on the girder of the wall.

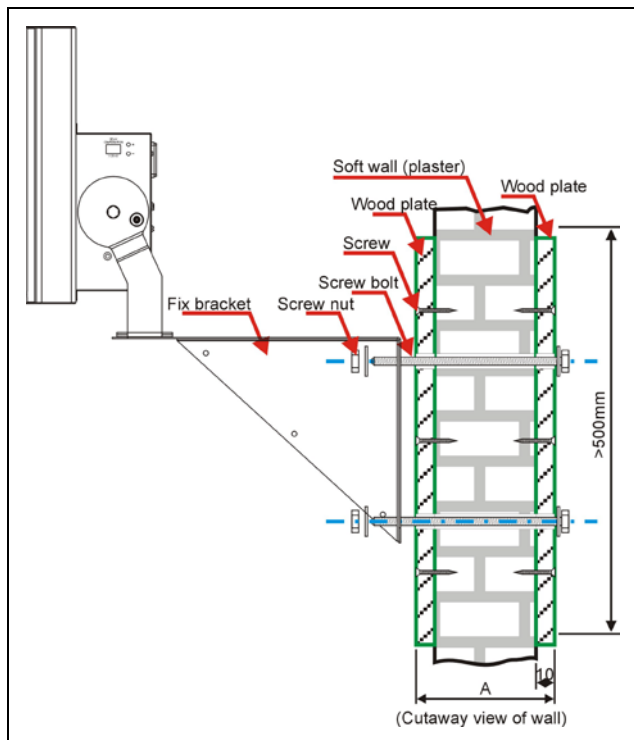

Figure 4.13 Wall mounting 3

4.4.3 Ceiling mounting

The radiator can be fixed to the ceiling by using the built-in bracket. Please make sure to have enough space for a proper air flow around the radiator when selecting ceiling mounting.

In most cases, a ventilator is needed to prevent overheating.

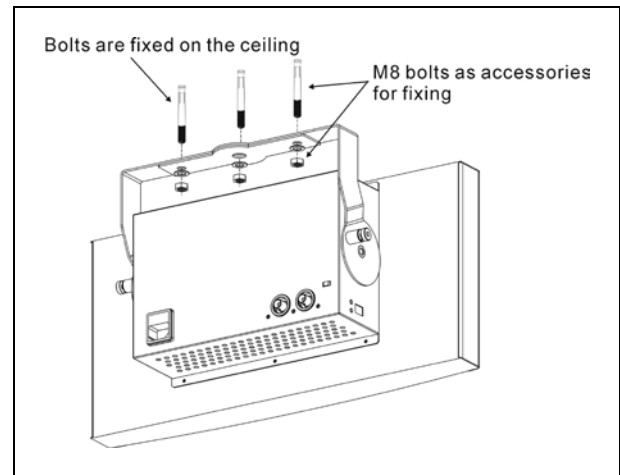

Figure 4.14 Ceiling mounting

4.4.4 Mounting on horizontal surface

If the radiator has to be installed on a horizontal plane (e.g. on the top of an interpreter booth), the distance between the radiator and the plane should be at least 4 cm to ensure enough airflow around the radiator. Normally, this can be achieved by using the built-in bracket as a support. If not, switch the radiator to half power. If the radiator is working at full power on top of an interpreter booth, the ambient temperature should not exceed 35 °C

4.5 Connecting to transmitter

There are six functionally identical HF signal output interfaces on the transmitter. Each one can connect up to 30 radiators by daisy chain. The radiators are connected with RG-59 cables. The maximum cable length per output is 300 m.

Note:

- Do not leave an open-ended cable connected to the last radiator in a loop-through chain.

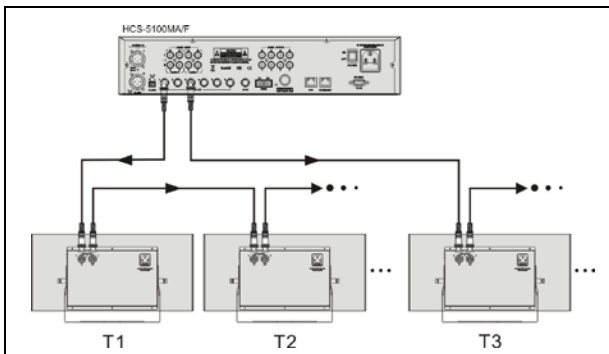

Figure 4.15 Radiators connected by daisy chain

4.6 Output power selection

The radiator can be switched to half power output. This is usually done when full power output is not needed, e.g. when a portable system is used in a small venue. Switch a radiator to half power if an adequate airflow cannot be guaranteed, e.g. if the radiator is mounted on the top of an interpreter booth. Reduce the power as often as possible to save energy and to increase the lifetime of the radiator.

4.7 Setting the radiator delay switches

As described in section 1.3.6, signals picked up by the receiver from two or more radiators can cause blind area due to delay differences.

Signal delays reasons:

- Cable signal delay, caused by the cable transporting the signal from the transmitter to the radiator.
- Radiation signal delay, caused by the air transporting the signal from the radiator to the receiver.
- Transmitter signal delay, caused if two or more transmitters are used in a Bypass configuration.

To compensate the signal delay differences, the delay of each radiator can be increased. HCS-5100 radiator has a digital display showing the current compensation value. Signal delays can be set with the delay switch situated at the side of the radiator. The switch can be adjusted from “00” (“00” means no compensation) to “99”. Compensation time is calculated by multiplying 25 ns with the switch set value. Thus compensation time varies between 25ns and 2475 ns.

In most cases the cable signal delays can be calculated manually using in addition the delay switch calculation tool (available on the documentation CD-ROM).

How to calculate the delay switch positions manually for systems with one, two or more transmitters will be described in the next sections. Refer to the delay switch calculation tool for information how to do to get a computed value for the delay switch position.

4.7.1 System with one transmitter

There are no cable signal delays in systems with only one transmitter and radiators directly connected to the transmitter with cables of identical length. The delay switches on all radiators are to be set to zero.

Subsequently check whether to compensate for radiation signal delay (see section 4.3.3).

If the cable lengths differ from radiator to radiator, the delay switch parameter can be calculated with the formula:

$$X = \frac{(L_{MAX} - L) \times 5}{25}$$

- Take signal delay rate as 5.0 ns/m (value as an example for calculation only, real value depends on the cable type used)
- X: delay compensation parameter, displayed on the LCD
- L_{MAX}: maximum cable length in the considered chain. For the most distanced radiator, L_{MAX} and L are identical.
- L: cable length between transmitter and radiator

Use the following procedure to determine the delay switch position based on cable lengths:

1. Measure the cable length L between the transmitter and every single radiator;
2. Determine the maximum cable length L_{MAX};
3. For each radiator calculate the cable length difference value L_{MAX} - L;
4. To obtain the cable signal delays for each radiator; multiply the cable length difference of each radiator with the cable signal delay per meter;
5. Divide the calculated signal delay difference by 25. The rounded off figure is the signal delay switch position for the radiator;
6. If applicable, add delay switch positions for radiators under a balcony, (see section 4.7.3);
7. Set the delay switches to the calculated switch positions.

Figure 4.16 and table 4.1 illustrate the calculation of the cable signal delay.

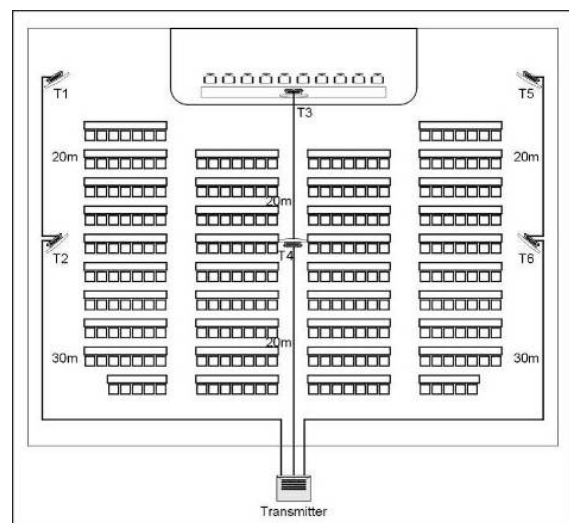

Figure 4.16 System with 6 radiators and measured cable lengths

Table 4.1 Calculation of the cable signal delays

Radiator number	Total cable length L(m)	Cable length difference $L_{MAX}-L(m)$	Cable signal delay per meter (ns/m)	Signal delay difference (ns)	Delay switch position
1	30+20=50*	50 - 50 = 0	5.0	0*5.0 = 0	0/25 = 0
2	30	50 - 30 = 20	5.0	20*5.0 =100	100/25 = 4
3	20+20=40	50 - 40 = 10	5.0	10*5.0 = 50	50/25 = 2
4	20	50 - 20 = 30	5.0	30*5.0 =150	150/25 = 6
5	30+20=50*	50 - 50 = 0	5.0	0*5.0 = 0	0/25 = 0
6	30	50 - 30 = 20	5.0	20*5.0 =100	100/25 = 4

* $L_{MAX}=50$ m

Note:

☞ The used cable signal delay per meter is only serving as an example. For your calculation, use the actual signal delay per meter value specified by the cable manufacturer.

4.7.2 System with two or more transmitters in one room

When radiators in one multipurpose room are connected to two transmitters, an extra signal delay is added by:

- Transmission from master transmitter to bypass transmitter (cable signal delay)
- Transmission through the bypass transmitter.

Use the following procedure to determine the delay switch positions in bypass mode:

1. According to the procedures for a system with one transmitter, calculate the cable signal delay for each radiator in Hall-1 and Hall-2;
2. Calculate the signal delay between the master and the bypass transmitter (Table 4.2);
3. Add the master-to-bypass signal delay to each radiator connected to the bypass transmitter in Hall-2;
4. Determine the maximum signal delay;
5. For each radiator calculate the signal delay difference by subtracting the cable signal delay from the maximum signal delay;

6. Divide the signal delay difference by 25. The rounded off number is the signal delay switch position for the radiator;
7. If needed, add delay switch positions to radiators under a balcony (see section 4.7.3);
8. Set the delay switches to the calculated delay switch positions.

Note:

☞ If a master-bypass mode is used for two rooms that are always separated, the delay switch positions can be calculated separately for each system and the delay caused by transmission from master to bypass transmitter can be ignored.

Figure 4.17, table 4.2 and table 4.3 illustrate the calculation of the extra master- bypass signal delay.

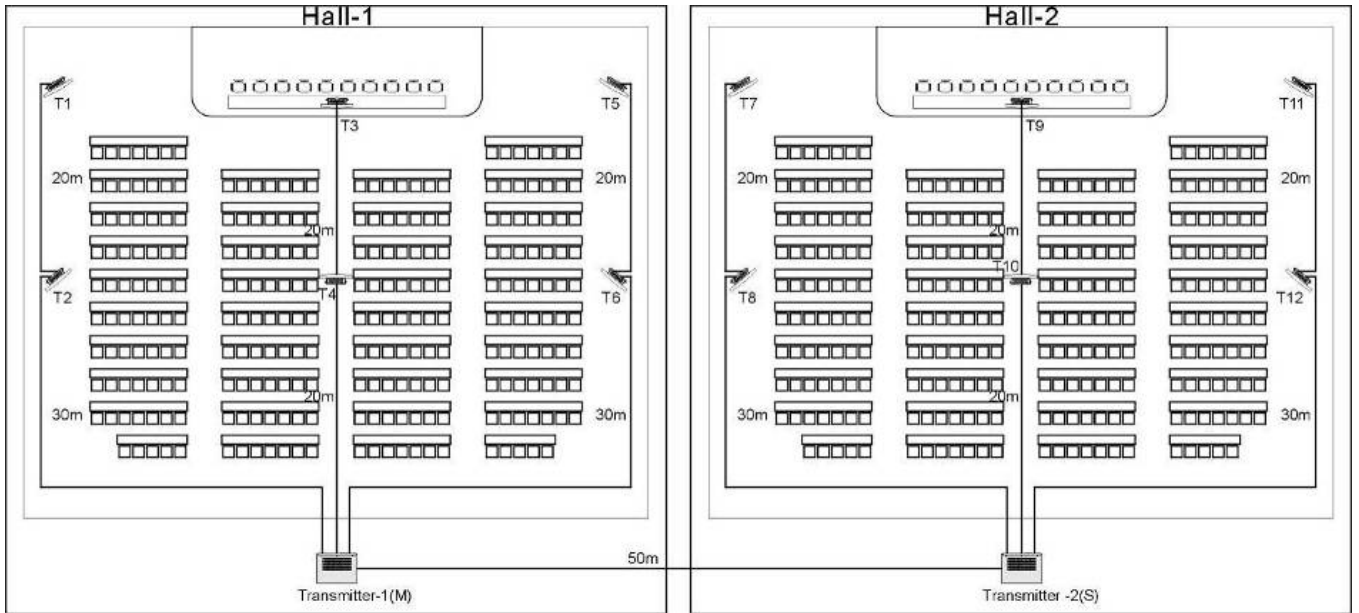

Figure 4.17 System with master and bypass transmitter in multi purpose room

Table 4.2 Calculation of the master-bypass signal delay

Master-bypass transmitter cable length (m)	Cable signal delay per meter (ns/m)	Master-bypass signal delay (ns)
50	5.0	$50 \times 5.0 = 250$

Table 4.3 Calculation of the delay switch positions of a system with two transmitters

Radiator number	Transmitter	Cable length to transmitter (m)	Cable Signal delay (ns)	Master-bypass signal delay (ns)	Total signal delay (ns)	Signal delay difference (ns)	Delay switch position
Hall-1-T1	"Master"	50	$50 \times 5.0 = 250$	0	$0 + 250 = 250$	$500 - 250 = 250$	$250 / 25 = 10$
Hall-1-T2	"Master"	30	$30 \times 5.0 = 150$	0	$0 + 150 = 150$	$500 - 150 = 350$	$350 / 25 = 14$
Hall-1-T3	"Master"	40	$40 \times 5.0 = 200$	0	$0 + 200 = 200$	$500 - 200 = 300$	$300 / 25 = 12$
Hall-1-T4	"Master"	20	$20 \times 5.0 = 100$	0	$0 + 100 = 100$	$500 - 100 = 400$	$400 / 25 = 16$
Hall-1-T5	"Master"	50	$50 \times 5.0 = 250$	0	$0 + 250 = 250$	$500 - 250 = 250$	$250 / 25 = 10$
Hall-1-T6	"Master"	30	$30 \times 5.0 = 150$	0	$0 + 150 = 150$	$500 - 150 = 350$	$350 / 25 = 14$
Hall-2-T7	"Bypass"	50	$50 \times 5.0 = 250$	250	$250 + 250 = 500^*$	$500 - 500 = 0$	$0 / 25 = 0$
Hall-2-T8	"Bypass"	30	$30 \times 5.0 = 150$	250	$250 + 150 = 400$	$500 - 400 = 100$	$100 / 25 = 4$
Hall-2-T9	"Bypass"	40	$40 \times 5.0 = 200$	250	$250 + 200 = 450$	$500 - 450 = 50$	$50 / 25 = 2$
Hall-2-T10	"Bypass"	20	$20 \times 5.0 = 100$	250	$250 + 100 = 350$	$500 - 350 = 150$	$150 / 25 = 6$
Hall-2-T11	"Bypass"	50	$50 \times 5.0 = 250$	250	$250 + 250 = 500^*$	$500 - 500 = 0$	$0 / 25 = 0$
Hall-2-T12	"Bypass"	30	$30 \times 5.0 = 150$	250	$250 + 150 = 400$	$500 - 400 = 100$	$100 / 25 = 4$

* The maximum signal delay is 500 ns

4.7.3 System with more than 4 carriers and a radiator under a balcony

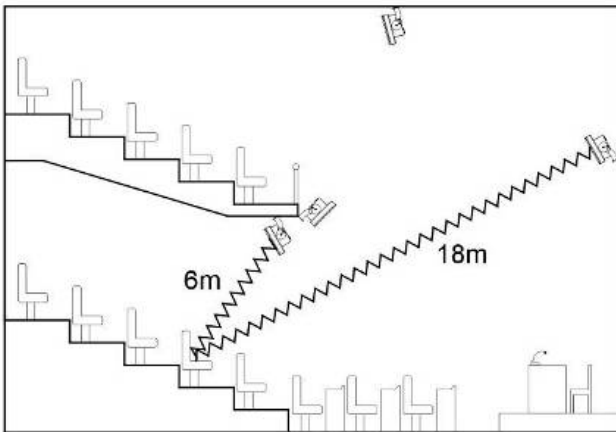

Figure 4.18 Radiation path length difference for two radiators

Figure 4.18 shows a radiation signal delay which needs to be compensated. For a system with more than four carriers, add one delay switch position per 8 meters difference in signal path length to the radiators that are closest to the overlapping coverage area. In figure 4.18 the signal path length difference is 12 meter. Add one delay switch position to the switch position(s) for the radiator(s) under the balcony.

4.7.4 System that mixes TAIDEN radiator with other brands compatible radiator

The radiators in above-mentioned systems are all TAIDEN HCS-5100 Series Radiator. The delay of electric input to light output of this radiator is 360 ns. Other brands on the market have a higher electric input to light output delay - for example 760 ns which means a 400 ns higher delay compared to TAIDEN HCS-5100 (equivalent to the delay caused by about 80 m of cable, i.e.16 steps of delay switch position). The reason for these delay differences is due to the use of different AD converters. If TAIDEN HCS-5100 radiators are worked together with radiators of other brands in a system, the differences in delay of electric input to light output must be taken into consideration.

Chapter 5. Digital Infrared Receiver

5.1 Overview

HCS-5100R/RA is a series of Digital Infrared Receivers, which can receive up to 40 language channels. Both rechargeable Li-ion battery and disposable battery can be used. The receiver is equipped with channel selector, volume control, power switch, Ø 3.5 mm stereo earphone jack, and charging circuit on the PCB. A LCD displays channel number with language name, received signal intensity, battery capacity and volume.

Types:

HCS-5100R/04F/08F/16F/32F/40F

4, 8, 16, 32, 40 CHs Digital Infrared Receiver (LCD, language display, optional rechargeable battery pack or 2xAA alkaline cells)

HCS-5100RA/04F/08F

4, 8 CHs Digital Infrared Receiver (LCD, language display, 2xAA alkaline cells)

5.2 Functions and indications

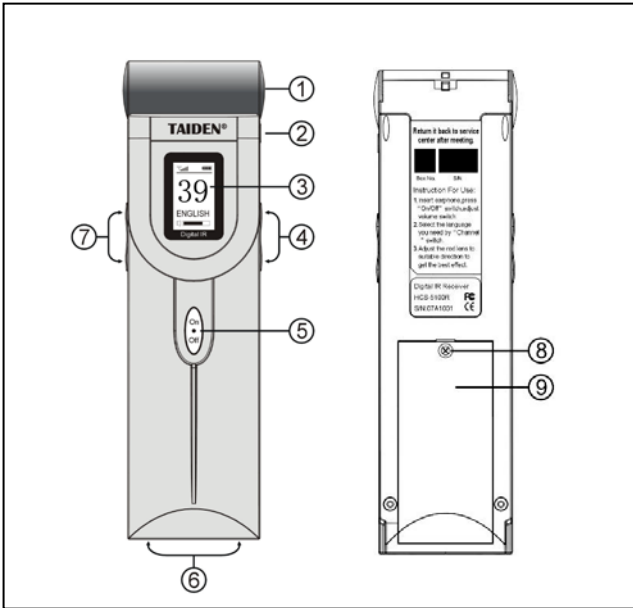

Figure 5.1 HCS-5100R/RA receiver

Note:

- When the receiver is not used, please disconnect the earphone. This ensures that the receiver is totally switched-off and no energy is consumed from the batteries or the battery pack.

Figure 5.1:

1. Infrared red filtering glass

- For receiving IR signal

2. Earphone jack

- Ø 3.5 mm jack for stereo monitor earphone

3. LCD

- Displays channel number, language, battery capacity, signal intensity and volume

4. Channel selector

- An up/down switch to select the audio channel. The channel number and the language name will be displayed on the LCD.

5. Power switch

- When the earphone is plugged in, the receiver changes to stand-by status. Press the power switch to turn on the receiver. Press and hold it for 2 seconds will return to stand-by status

6. Charging contacts

- Used for charging

7. Volume control

- An up/down switch to adjust the volume, the volume will be displayed on the LCD

8. Screw to fix the battery cover

9. Position for battery pack or disposable batteries

5.3 Operation

The receiver only works when an earphone is connected and the receiver switches to stand-by state. Push shortly on the power switch button to switch on the receiver. The channel number is shown on the LCD. The channel can be changed with the channel selector. The channel number is in accordance with the channel configuration set up in the transmitter.

When working, the battery icon and the antenna icon will be displayed on the LCD to indicate the current battery and signal status. A battery symbol "☐" is visible on the display when the batteries or the battery pack is almost empty and needs recharging, but it still might work for 7-8 hours. When the signal is interrupted for a short time, the receiver mutes the earphones output. If the IR receiver does not get an adequate IR signal for more than 2 minutes (e.g. when a delegate leaves the conference room), the receiver switches to stand-by state automatically.

The volume can be adjusted and displayed on the LCD.

To switch the receiver manually to stand-by mode, simply press and hold the on/off button for more than 2 seconds. If the earphone is disconnected, the receiver is switched off automatically.

The infrared receivers are operable either with disposable batteries (2xAA alkaline cells) or with a rechargeable battery pack (HCS-5100BAT-Li).

Install the batteries or the battery pack with the correct polarity, as indicated in the battery compartment. A separate connection cable is required if a battery pack is used. The charging circuitry will not work if this cable is missing, preventing thus also charging of disposable batteries by mistake. The battery pack is equipped with a temperature sensor to prevent overheating during charging.

For more details about charging the battery pack please refer to chapter [7](#).

Note:

- ☞ When the receiver will not be used in a long time, please take out the batteries out to avoid any leakage or corrosion.
- ☞ At the end of their technical lives both disposable batteries and battery packs should be discarded according to ecological standards, preferably at your nearest recycling station.

5.4 Testing the coverage area

To make sure that the whole area is covered with adequate IR radiation and avoiding thus blind area, an extended reception quality test should be done. The test can be done in the follow way:

Testing during installation

1. Check that all radiators are connected and powered up;
2. Set the transmitter in the Test-mode. For each channel, a test tone frequency will be transmitted;
3. Set a receiver to the highest available channel and listen to the received signal through the headphones;
4. Test all positions and directions (see next paragraph).

Testing all positions and directions

Walk around the conference venue under the test mode of the transmitter; test every position where the signal must be received. If an area is detected as having bad reception or even no reception at all, two main causes should be taken into consideration:

■ Bad signal coverage area

If the receiver cannot pick-up adequate infrared radiation, it is possible that the tested position exceeds the footprint of the installed radiators or the radiation is blocked by obstacles such as a column, an overhanging balcony or other large objects.

Check whether you used the correct footprints for the system design or not. Check if the radiators used have sufficient output power and are not switched to half power operation by mistake. If bad reception is caused by a blocked radiation path, try to remove the blocking obstacle or add an extra radiator to cover the blind area with more IR energy.

■ Blind area

IR signals coming from two radiators may cancel out each other (multipath effect) when reaching the receiver. Bad reception only happens on some special path. Multipath effect is confirmed being the cause of bad reception if the bad signal received by the receiver is improving the instant a radiator is a) changing the

direction of the receiver b) shaded-off or simply switched-off. IR radiation, reflected from a surface with a high reflectivity may also cause multipath effect.

Check that the signal delay compensation switches on the radiators are set to the correct value. Check the system design. If necessary, reduce the distance between the two radiators that cause the problem and/or add an extra radiator.

Please note that due to the physical characteristics of the signal distribution, it is not possible to avoid multipath effects completely.

5.5 Earphones

The earphones are connected to the conference units via a \varnothing 3.5 mm stereo jack. Suitable earphone types include:

- EP-820AS single earphone



- EP-829 single earphone



- EP-829 single earphone



- HCS-5100PA headphone



- EP-960BH headphone



- Any other compatible type (see chapter [9](#), Technical Data).

5.6 Li-ion Rechargeable Battery Pack

- HCS-5100BAT-Li Li-ion rechargeable battery pack



Chapter 6. Web server

Running environment: browser for Firefox29.0, Google25.0, IE10 or higher version.

6.1 Login and exit

The user inputs the IP address of CMU into the Web browser to login. The default UserName is “admin” and default Password is “123456”, the password can be changed after login. The default username is administrators that cannot be deleted. The login interface is shown in the following figure:

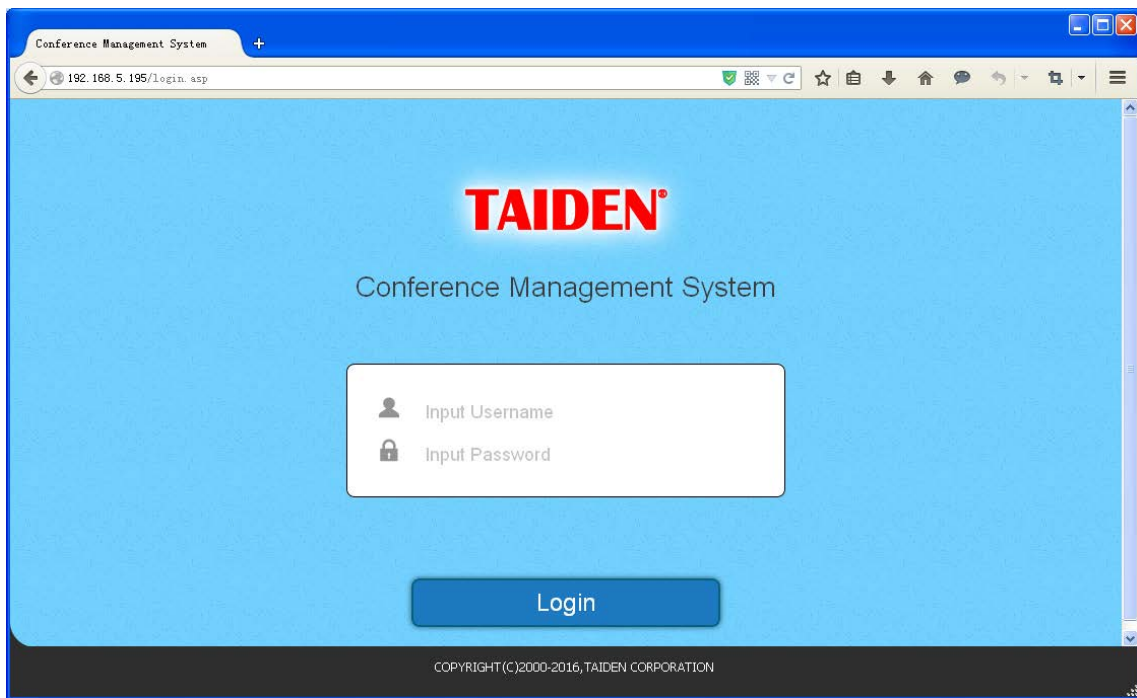

Figure 6.1 Login

Input the UserName and Password, then click the “Login” button and it will enter the conference management system interface automatically.

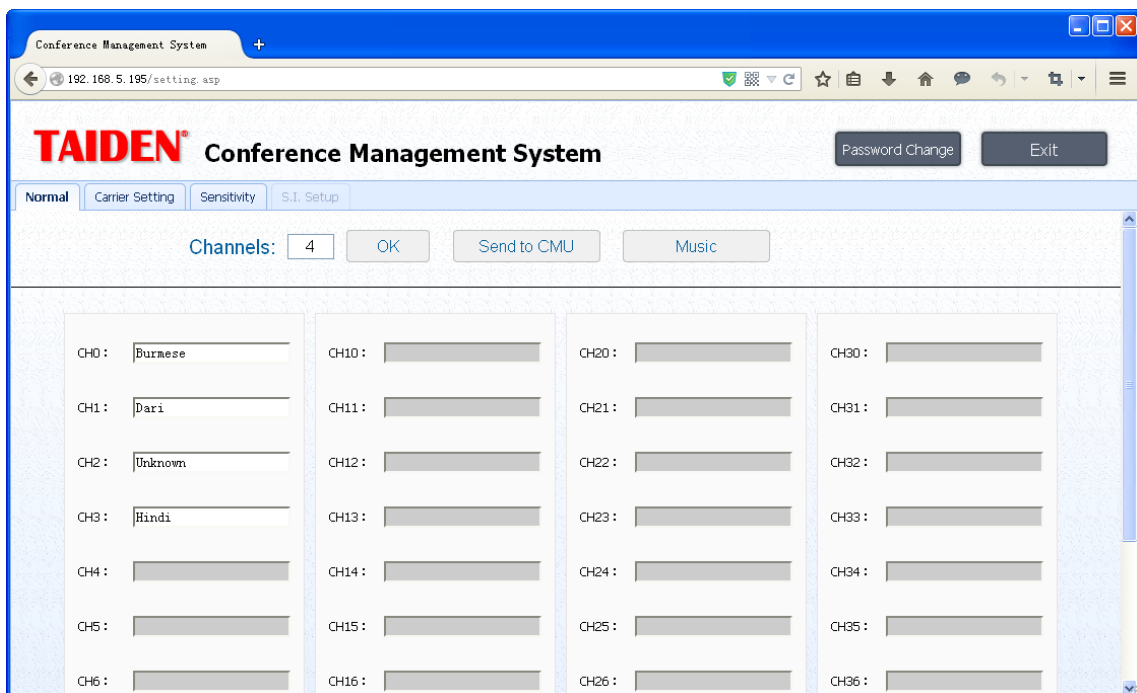

Figure 6.2 Conference Management System

There are two buttons in the right top of the interface:

- **Password Change:** click this button and the below dialog box is shown:

Input the Old Password, New Password and Password Confirm, and then click the “OK” button to change the password.

Note:

Password only supports a sequence of numbers or letters (case sensitive) with maximal 20 characters.

- **Exit:** exit the conference management system.

6.2 Conference management

The conference management includes: Normal, Carrier Setting, Sensitivity and S.I. Setup. These functions can be setup according the work mode of the main unit (see table 6.1).

Table 6.1 Function list of the work mode of main unit

Function Work mode	Normal	Carrier Setting	Sensitivity	S.I. Setup
Master-Analog	√	√	√	--
Master-Interp.U	--	--	--	√
Master-Central.U	--	--	--	--
Master-Dante	√	--	--	--
Bypass	--	--	--	--

6.2.1 Normal

User can assign the quantity and language of the SI channels, or play music. The interface is shown in the following figure:

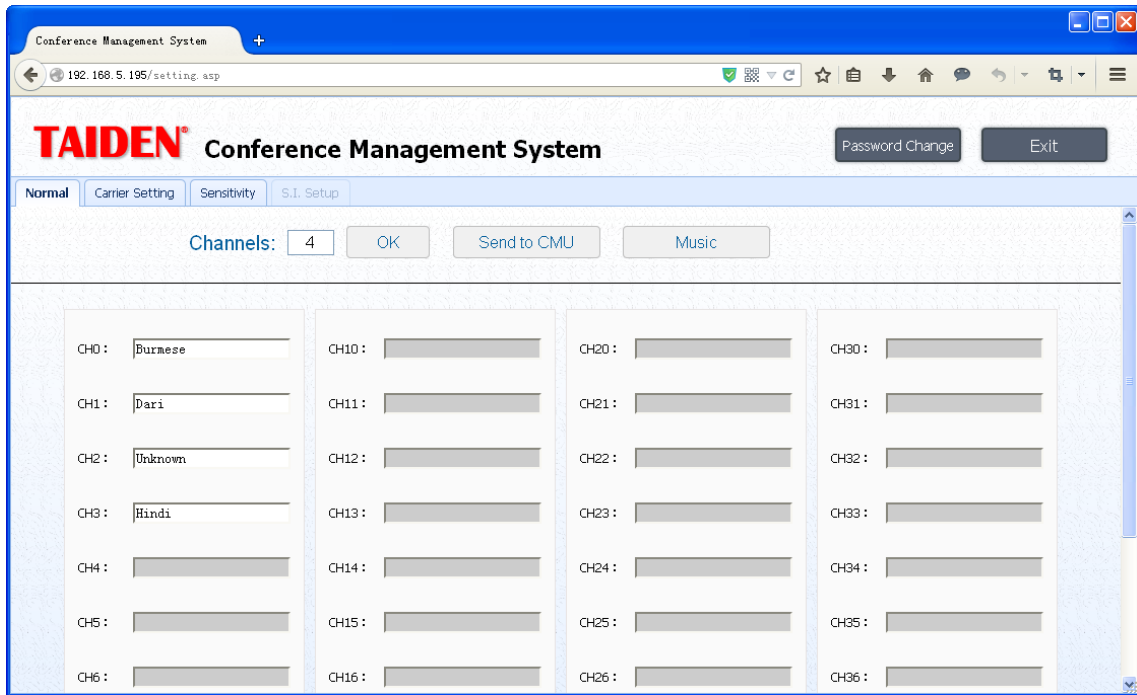
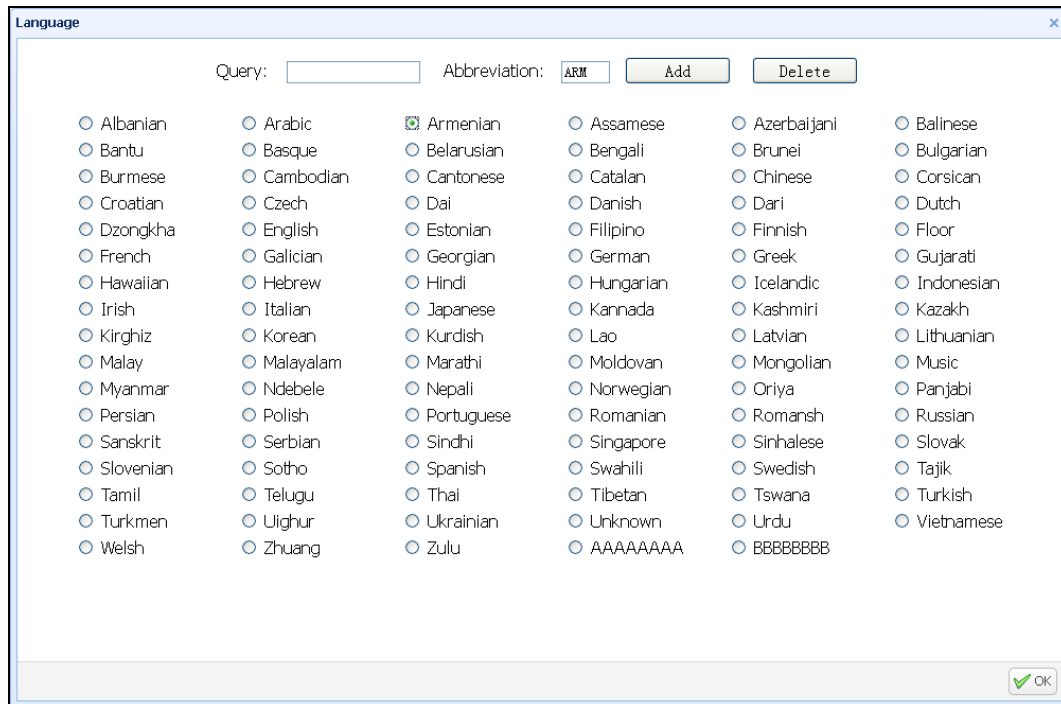

Figure 6.3 Normal setting

- **Channels:** set up the number of simultaneous interpretation channel;
- **CH:** assign a language from the list for each channel. Languages also can be added or deleted conveniently, supports 40 user-defined languages at most. However, the languages listed by the system cannot be modified or deleted. Click “OK” after setting:



Note:

The user-defined language must include the full name and its abbreviation. The full name only supports a sequence of numbers or letters (case sensitive) with maximal 8 characters and the abbreviation supports 3 characters at most conference main unit.

- **Send to CMU:** save the current setting and send it to the main unit;
- **Music:** plays music to all channels.

6.2.2 Carrier Setting

Carrier setting includes AUX. mode setting, carrier setting, etc..

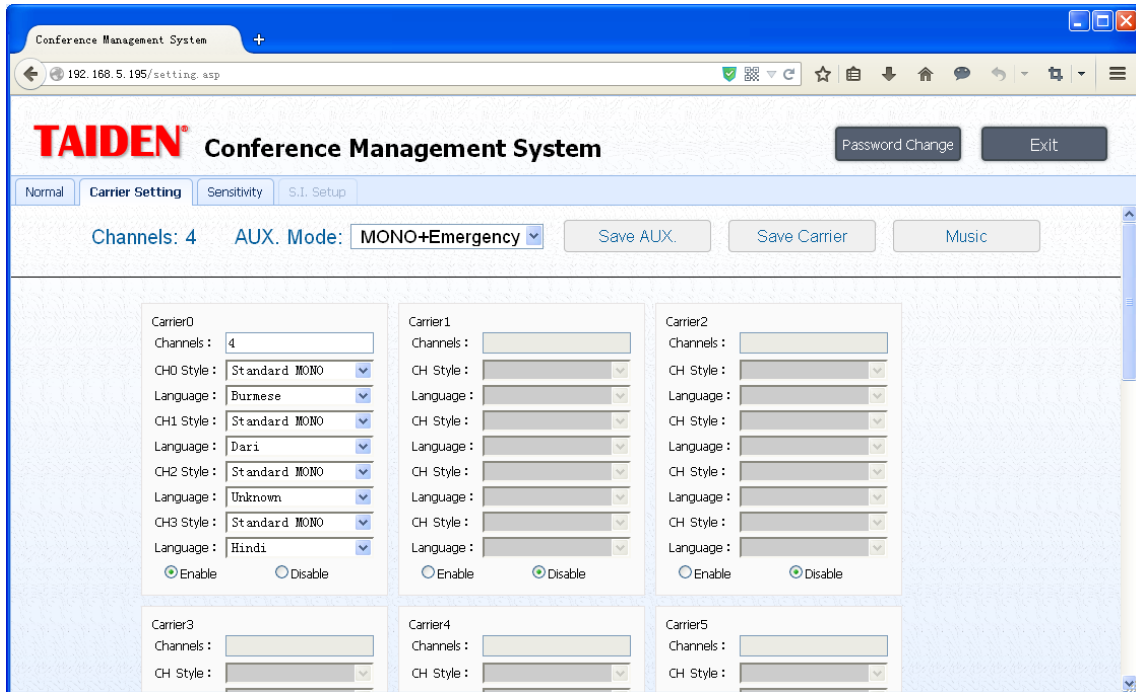

Figure 6.4 Carrier setting

- **AUX. Mode:** includes “Stereo Music” and “Mono+Emergency”;
 - “**Stereo Music**”: stereo music from 2 channels auxiliary audio input will be distributed to all output channels, usually for playing music when adjournment;
 - “**Mono+Emergency**”: once the alarm signal is turned on, the emergency signal from Aux-R audio input will be distributed to all output channels on the premise that fire alarm linked trigger interface is closed.
- **Save AUX.**
- **Carrier:** set up the used status, channel quantity, language and audio type of each carrier;
 - Channels:** channel number of the carrier, every carrier supports 4 channels at most;
 - CH Style:** includes 4 types: “Standard MONO”, “Perfect MONO”, “Standard STEREO” and “Perfect STEREO”. The selectable audio quality depends on the channel number (refer to section [1.2.5](#)).
 - Language:** setting the channel language;
 - Enable/disable:** enable/disable the carrier setting;
- **Save Carrier**
- **Music:** plays music to all channels.

6.2.3 Sensitivity

Adjust the sensitivity of each channel and auxiliary audio. The interface as shown in the following figure:

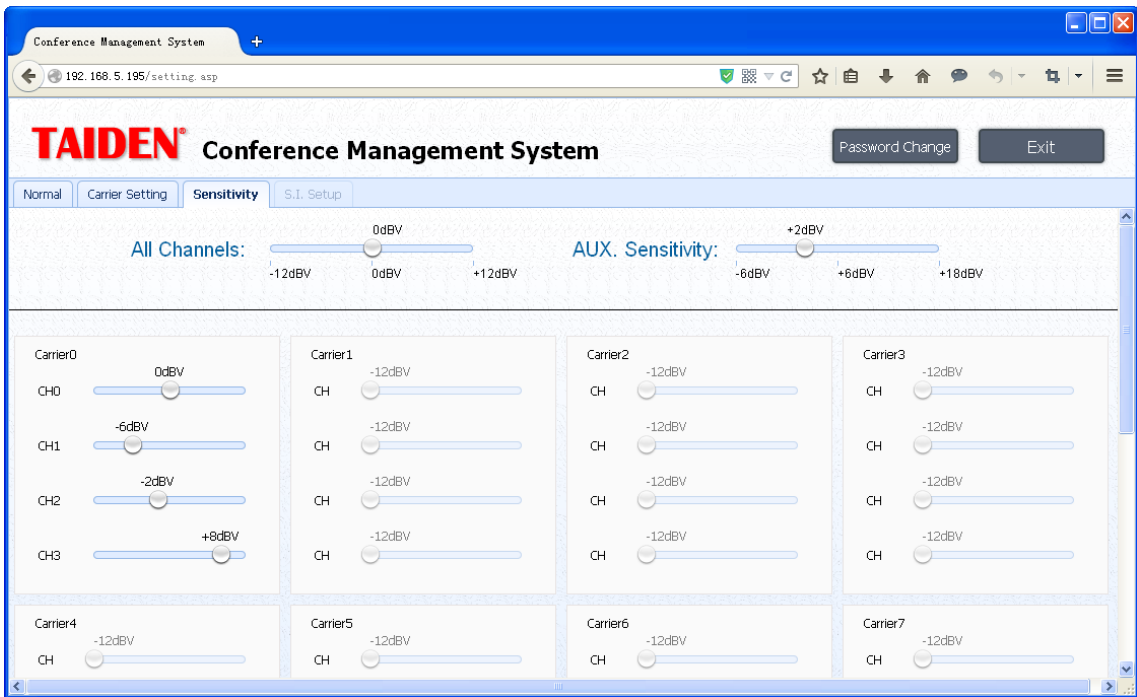

Figure 6.5 Sensitivity Setting

- **All Channels:** adjust the max. level for all audio inputs. Range from -12 dBV - +12 dBV;
- **AUX. Sensitivity:** adjust the max. level for auxiliary audio inputs. Range from -6 dBV - +18 dBV;
- **CH:** adjust the max. level for each audio input. Range from -12 dBV - +12 dBV.

6.2.4 S.I. Setup

Setup of simultaneous interpretation channel and the outgoing languages for the A, B, C channels for each interpreter booth in “Master-Interp.U” mode. The interface as shown in the following figure:

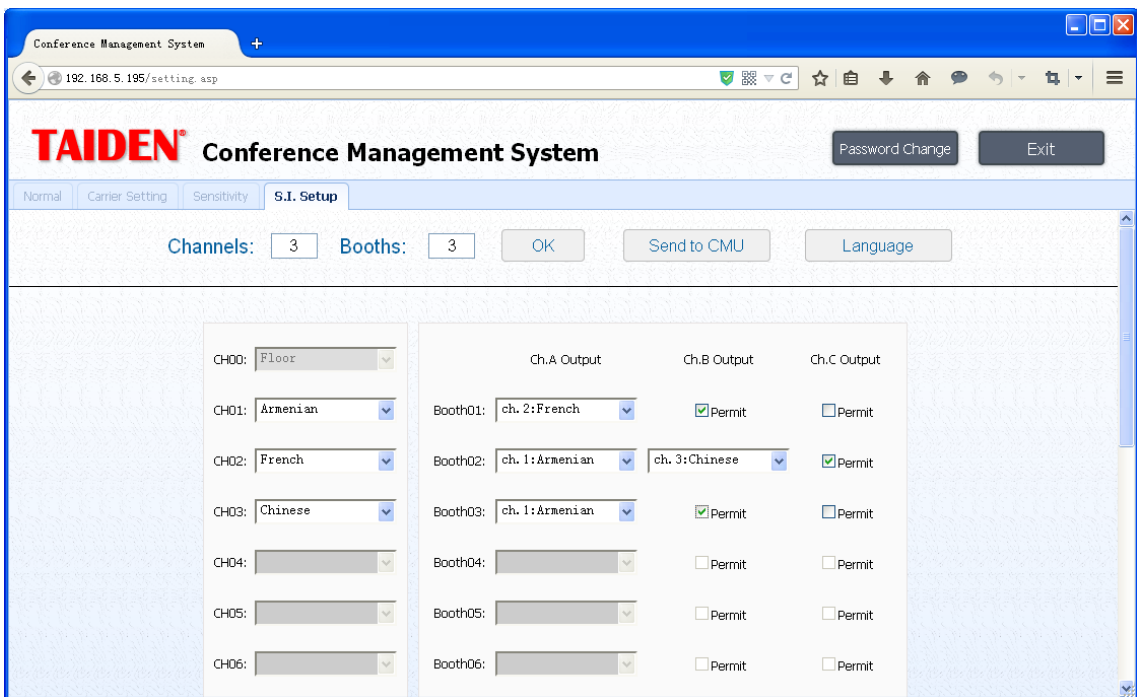
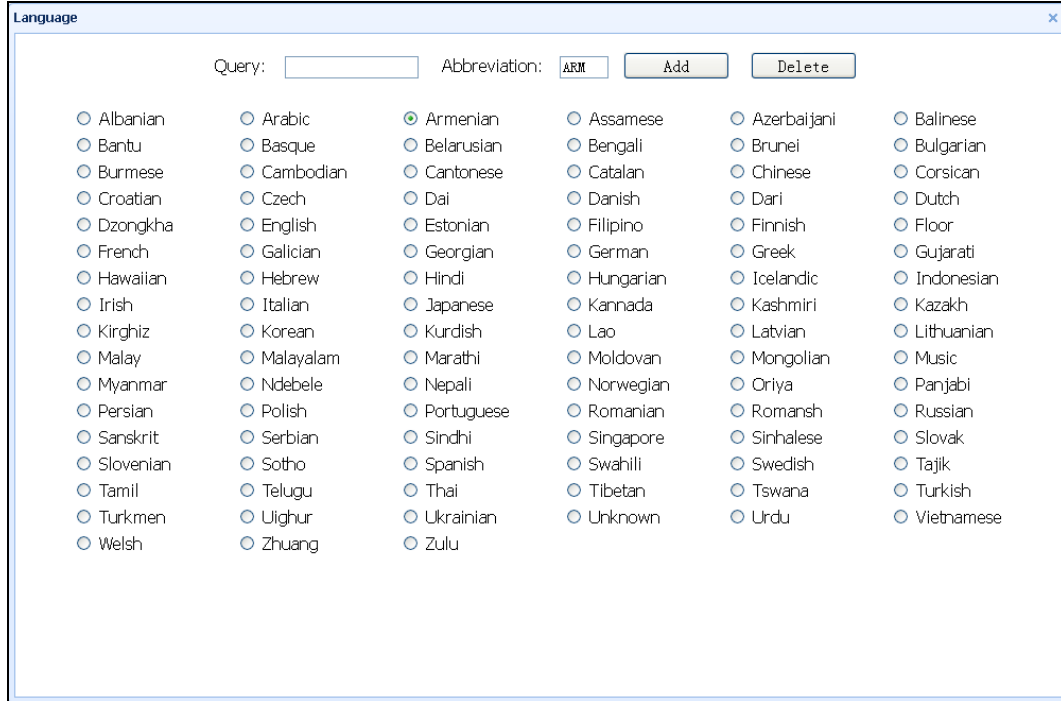

Figure 6.6 S.I. Setup

- **Channels:** set up the number of simultaneous interpretation channel;
- **Booths:** set up the number of interpreter booth;

The system supports 15 interpreter booths. Each booth should set the outgoing A channel, and whether outgoing B and C channel is needed. If the outgoing C channel is permitted, the outgoing language of B channel should be set. All settings shall be configured according to the actual conference requirements. When the setup is completed, click the “Send to CMU” button to save the settings and to update the conference main unit.

- **Language:** Languages can be added or deleted conveniently, support 40 user-defined languages at most. However, the languages listed by the system cannot be modified or deleted, as shown in the figure below:



Note:

The user-defined language must include the full name and its abbreviation. The full name only supports a sequence of numbers or letters (case sensitive) with maximal 8 characters and the abbreviation supports 3 characters at most.

Chapter 7. Charging Case and Storage case

7.1 Charging case

7.1.1 Overview

The charging Case can charge up to 60 receivers at a time. It uses universal power supply with automatic voltage matching. There is a charging indicator on the receiver. The charging circuit will check if the battery pack is present and control the charging process.

Note:

☞ The Charging Case is only used to charge HCS-5100R/F with battery pack HCS-5100BAT-Li. Please do not charge other receiver types with HCS-5100CHG/60 or charge HCS-5100R/F with other charging unit.

7.1.2 Charging procedure

1. Connect power cord;
2. Switch on;
3. Insert receiver;
4. Receiver charging indicator lights up.

LED Status	Charging Status
On	Charging completed
Blinking	Charging
Off	Charger power off or receiver not inserted properly.

Note:

- ☞ Pull out the earphone before charging the receiver.
- ☞ Switch on the charger before inserting the receiver. Inserting and removing the receiver when the charger is powered on will not damage the receiver.
- ☞ To maintain the service life of the Ni-MH battery, please charge it for 24 hours before first service (even if the charging indicator keeps lighting).
- ☞ The charging case supplies fast charge during the first 10 minutes after inserting the receiver. So please do not frequently insert and remove the receiver to protect the battery pack.
- ☞ Continuously charging will not damage the receiver or the battery pack.
- ☞ Please charge up the receiver in a temperature between 0 and 45 centigrade, or else will tamper with the life of receiver.
- ☞ It will result in low battery and may damage the battery pack if the battery pack is not used for a long time. Please fully charge the battery every three months.
- ☞ Please check the battery pack regularly every 3 years whether the battery pack is leaking or not. If any leakage or corrosion is detected, please replace the battery pack. Please use HCS-5100BAT-Li only. The battery pack should be replaced at least every 5 years.

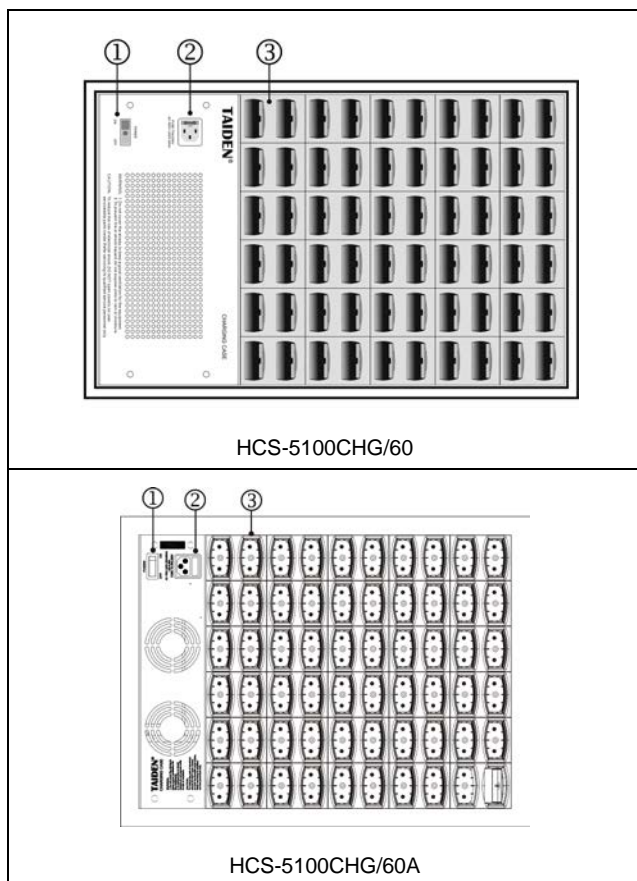

Figure 7.1 Charging Case

1. Power switch

- Just switches on/off power for charging lattice.
Does not switch power input

2. Power input

3. Charging lattice

7.2 Storage case

HCS-5100KS storage case is used to store and to transport IR receivers (HCS-5100R/RA/F). It can contain 100 receivers in 1 storage case.



Figure 7.2 HCS-5100KS storage case

Chapter 8. Fault diagnosis

Some simple trouble-shooting instructions are provided in this chapter. If more serious faults arise, please contact a qualified technician.

Fault	Solution
Transmitter display does not light up	<ul style="list-style-type: none"> ✧ Confirm that transmitter power cord is connected correctly and the power is switched on.
Emergency does not work	<ul style="list-style-type: none"> ✧ Confirm that the emergency is connected correctly. ✧ Confirm that "Alarm setting" is enabled.
Radiator power light does not light up	<ul style="list-style-type: none"> ✧ Confirm that radiator power cord is connected correctly.
Radiator input indicator does not light up	<ul style="list-style-type: none"> ✧ Confirm that the radiator input cable is connected correctly.
Receiver does not work properly	<ul style="list-style-type: none"> ✧ If dry batteries are used, please make sure that the batteries have sufficient capacity and are assembled properly. ✧ If rechargeable batteries are used, please make sure that the batteries are fully charged. ✧ Confirm that the earphone is connected correctly. ✧ Switch on the receiver and confirm that the channel indicator works properly. ✧ Make sure that the receiver picks up sufficient IR signal and check the antenna signal intensity indicator. ✧ Check the receiver by taking it in front of the mini radiator of the transmitter front panel. ✧ Make sure that the volume is turned up. ✧ Set the transmitter to test mode and check if the test tone is audible from the receiver. ✧ If all receivers do not work properly at this spot, testing the coverage area as section 5.4.
Receiver sound with noise	<ul style="list-style-type: none"> ✧ Adjust the receiving distance. ✧ Adjust the receiving direction. ✧ Switch radiator to full output.
The charging indicator of the receiver does not light up	<ul style="list-style-type: none"> ✧ Confirm that the Charging Case is working under proper conditions (see technical data). ✧ Confirm that the receiver battery pack is connected correctly. ✧ Confirm that the receiver is at normal temperature. ✧ If the charging indicator still does not light up, please replace the battery pack.
Receiver discharges quickly	<ul style="list-style-type: none"> ✧ Replace the rechargeable battery.
Bad signal coverage effect	<ul style="list-style-type: none"> ✧ Testing the coverage area as section 5.4.

Chapter 9. Technical data

9.1 System specification

System performance

Conforms to ISO 22259, the international standard for conference systems

Conforms to IEC 61603-7, the international standard for digital infra-red transmission of audio signals for conference and similar applications

Transmission characteristics

IR transmission wavelength	870 nm
Protocol and modulation	DQPSK, according to IEC 61603-7
Modulation frequency	1 to 8 MHz
	Carriers 0 to 5: 2 to 6 MHz, according to IEC 61603-7

Band allocation:

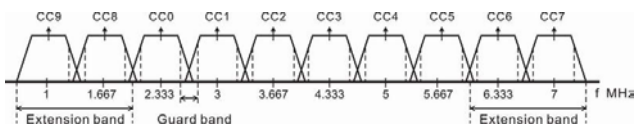

System audio performance

(Measured from the audio input of an HCS-5100M/F, HCS-5100M/A or HCS-5100M/B transmitter to the headphone output of an HCS-5100R/RA/F receiver.)

Audio frequency response	20 Hz to 10 kHz (-3 dB) at Standard Quality
	20 Hz to 20 kHz (-3 dB) at Perfect Quality
Total harmonic distortion at 1 kHz	≤0.05%
Isolation at 1 kHz	≥85 dB
Dynamic range	≥90 dB
Weighted signal-to-noise ratio	≥85 dBA

Cabling and system limits

Cable type	75 Ohm RG59
Maximum number of radiators	30 per HF output
Maximum cable length	300 m per HF output
Maximum length of Cat.5 cross-over cable	80 m per piece

System environmental conditions

Working conditions	Fixed/stationary/portable
Temperature range	
- Transport	-40 °C to +70 °C
- Operating	0 °C to +45 °C
Max. Relative humidity	< 95%
Safety	Compliant to EN 60065
EMC emission	Compliant to EN 55032
EMC immunity	Compliant to EN 55035
Approvals	CE, FCC
Power harmonic	Compliant to EN 61000-3-2
Voltage fluctuations and flicker	Compliant to EN 61000-3-3

9.2 Infrared transmitters

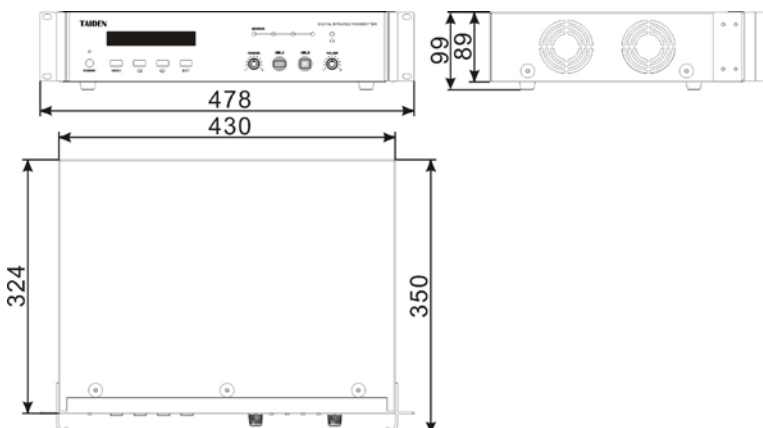
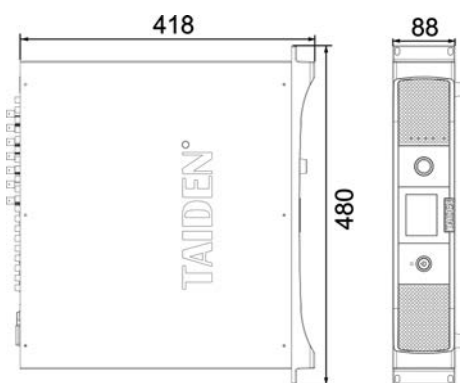
Type	HCS-5100MA/FS/F HCS-5100MA/FS/A HCS-5100MA/FS/B	HCS-5100MA/F HCS-5100MA/A HCS-5100MA/B	HCS-5100MC/FD HCS-5100MC/AD HCS-5100MC/BD	HCS-5100MC/F HCS-5100MC/A HCS-5100MC/B
Mains voltage	AC 100 V – 240 V, 50 Hz / 60 Hz			
Power consumption	Maximal 25 W			
Audio input	Balanced audio input: -6 dBV - +18 dBV Unbalanced audio inputs: -12 dBV - +12 dBV			
HF interface	Output: BNC × 6 Input: BNC × 1			
HF input/output	75 Ω			
External control	RS-232C D-sub, USB, RJ45			
Fiber interface	SC interface	-	-	-
Dante interface	-	-	RJ45	-
Display	256 x 32 LCD (HCS-5100M/F series) 2.8" LCD (HCS-5100M/A series and HCS-5100M/B series)			
Interpreter units connector	6-pin DIN		-	
Emergency switch connector	2-pin 3.81 mm Phoenix connector, alarm signal control input			
Headphone output	32 Ω - 2 kΩ			
Dimensions (mm)	 <p>HCS-5100M/F series</p>			
	 <p>HCS-5100M/A series ,HCS-5100M/B series</p>			
Weight	HCS-5100M/F	7.5 kg		
	HCS-5100M/A HCS-5100M/B	7 kg	6.8 kg	6.6 kg
Color	White (HCS-5100M/F series) Black (HCS-5100M/A series, HCS-5100M/B series)			

9.3 Radiators and accessories

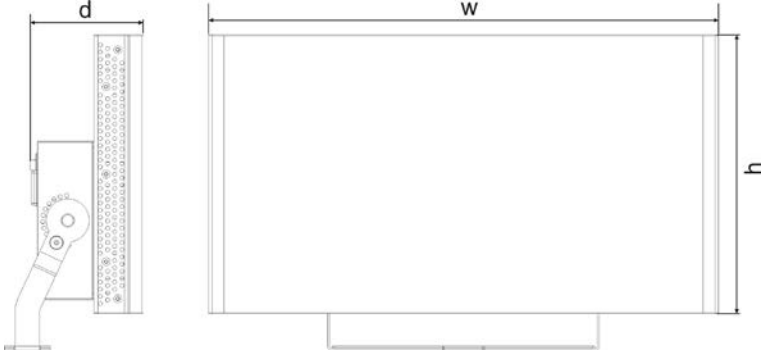
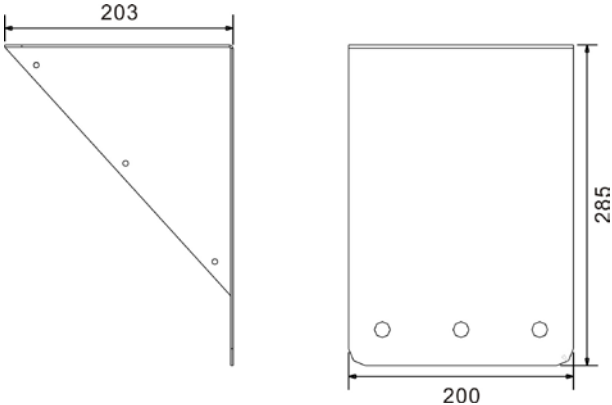
Type	HCS-5100T/15B	HCS-5100T/25B	HCS-5100T/35B
Mains voltage	AC 100 V – 240 V, 50 Hz / 60 Hz		
Power consumption	35 W	62 W	120W
Power consumption (standby)	3 W		
HF input/output	75 Ω		
Angle of half intensity	±22°		
Dimensions (mm) wxdxh			
	448x110x212	448x110x212	498x110x272
Weight (without bracket)	3.1 kg	3.1 kg	4.2 kg
Color	Dark red		
Mounting	Suspension bracket for direct ceiling mounting Mounting plates for floor stands Wall mounting bracket HCS-5100TBZJ can be used for fixing radiator to wall surfaces		
Dimensions for HCS-5100TBZJ (mm)			
Weight (HCS-5100TBZJ)	1.6 kg		
Color (HCS-5100TBZJ)	Silver gray		

9.4 Receiver

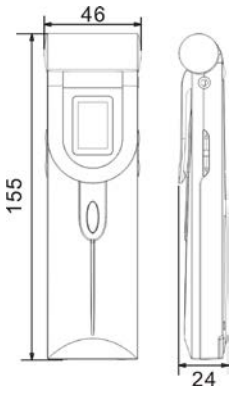
Type	HCS-5100R/RA/F
Supply voltage	2.5 V – 4.2 V, nominal 3.0 V
Power consumption	38 mA (32 Ohm headphone) 0 mA (unplug headphone jack)
IR irradiance level	4mW/m ² per carrier
Angle of sensitivity	270°
Headphone output level at 3.0 V	450 mVrms (speech at maximum volume, 32 Ohm headphone)
Headphone output freq. Range	20 Hz - 20 kHz
Headphone output impedance	32 Ω - 2 kΩ
SNR	≥ 85 dBA
Battery life	55 h (2xAA alkaline cells) 42 h (rechargeable battery pack)
Dimensions (mm)	
Weight	70 g (excl. batteries/battery pack)
	115 g (incl. batteries/battery pack)
Color	Black

9.5 Accessory

9.5.1 Earphones

● EP-820AS Single Earphone

- Used with the receiver/conference unit
- Hi-Fi sound quality
- Ø 3.5 mm stereo plug
- 32 Ohm (Tip and Sleeve, Ring: NC)
- Frequency response: 50 Hz to 20 kHz
- Sensitivity: ≥ 102 dBA/1 mW
- Weight: 20 g



● EP-829 Single Earphone

- Used with the receiver/conference unit
- Hi-Fi sound quality
- Ø 3.5 mm stereo plug
- 32 Ohm (Tip and Sleeve, Ring: NC)
- Frequency response: 20 Hz to 20 kHz
- Sensitivity: ≥ 108 dBA/1 mW
- Weight: 35 g



● EP-830 Single Earphone

- Used with the receiver/conference unit
- Hi-Fi sound quality
- Assembled with detachable shell, cable and earphone
- The shell can be removed and cleaned separately
- The cable can be replaced separately by customer if breaks
- Ø 3.5 mm stereo plug (TRS)
- 32 Ohm (Tip and Sleeve, Ring: NC)
- Frequency response: 20 Hz to 20 kHz

- Sensitivity: ≥ 108 dBA/1 mW
- Weight: 25 g



● HCS-5100PA headphone

- Used with the receiver/conference unit
- Hi-Fi sound quality
- 32 Ohm $\times 2$, Ø 3.5 mm stereo jack
- Frequency response: 20 Hz to 20 kHz
- Sensitivity: ≥ 108 dBA/1 mW
- Weight: 70 g



● EP-960BH headphone

- Used with the receiver/conference unit
- Hi-Fi sound quality
- 150 Ohm $\times 2$, Ø 3.5 mm stereo jack
- Frequency response: 20 Hz to 20 kHz
- Sensitivity: ≥ 108 dBA/1 mW
- One sided wire
- Weight: 90 g



9.5.2 Li-ion Rechargeable Battery Pack (HCS-5100BAT-Li)

Physical characteristics

Dimensions (HxWxD) 48x29x15 mm
 Weight 45 g

Electrical characteristics

Voltage 3.7 V
 Capacity 1500 mAh



9.5.4 Storage Case (HCS-5100KS)

Physical characteristics

Dimensions (HxWxD) 669x307x205 mm
 Weight 6 kg (excl. receivers)
 14kg (incl. 100 receivers, excl. batteries)
 Color Blue



9.5.3 Charging Case (HCS-5100CHG/60)

Physical characteristics

HCS-5100CHG/60:

Dimensions (HxWxD) 610x405x260 mm
 Weight 14.5 kg
 Color Blue

HCS-5100CHG/60A:

Dimensions (HxWxD) 525x400x265 mm
 Weight 11.3 kg
 Color Blue

Electrical characteristics

Mains voltage AC 100 - 240 V
 Power consumption 280 W (60 receivers charging)
 Power consumption (standby) 7 W (no receiver in charging unit)



9.5.5 HCS-4853T Cable Splitter

Physical characteristics

Dimensions (HxWxD) 35 x 149 x 90 mm
 Color Black

Electrical characteristics

Function Relay facility, amplification of the communication signals
 Input 2m-cable with a 6P-DIN connector at the input end
 Output Three 8PIN output interfaces, can drive 60-meter long extension cable



9.6 Connection details

9.6.1 Mains cables

Blue	Neutral
Brown	Live
Green/Yellow	Earth/Ground

9.6.2 Audio cables

3-pole XLR connector (female)

Pin 1	Earth
Pin 2	Signal +
Pin 3	Signal -

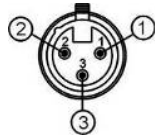

Chinch connector (male)

Pin 1	Signal +
Pin 2	GND



9.6.3 Earphones

3.5 mm Jack plug

Tip (1)	Signal left
Ring (2)	Signal Right
Sleeve (3)	Electrical earth/screen

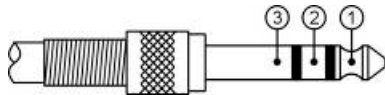

9.6.4 Emergency switch

Terminal block

Connect the emergency switch to +, -.

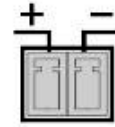

ALARM

9.7 Guaranteed rectangular footprints

NO. of carriers	Mounting height H(m)	Mounting angle	HCS-5100T/15B				HCS-5100T/25B				HCS-5100T/35B				
			Area A(m ²)	Length L(m)	Width W(m)	Offset X(m)	Area A(m ²)	Length L(m)	Width W(m)	Offset X(m)	Area A(m ²)	Length L(m)	Width W(m)	Offset X(m)	
1	2.5	0	242	22	11	4	819	39	21	6	1674	54	31	10	
	5	15	220	20	11	4	756	36	21	6	1632	51	32	10	
		30	170	17	10	3	589	31	19	4	1066	41	26	6	
		45	108	12	9	1	374	22	17	2	696	29	24	3	
		60	72	9	8	0	255	17	15	0	399	21	19	0	
		90	49	7	7	-3.5	144	12	12	-6	225	15	15	-7.5	
	10	15	220	20	11	6	836	38	22	8	1581	51	31	13	
		30	209	19	11	3	660	33	20	5	1260	45	28	7	
		45	150	15	10	1	513	27	19	2	875	35	25	3	
		60	120	12	10	-1	357	21	17	-1	621	27	23	-1	
		90	81	9	9	-4.5	342	18	19	-9.5	462	22	21	-10.5	
	25	30	160	16	10	8	416	26	16	12	828	36	23	19	
		45	135	15	9	4	375	25	15	6	748	34	22	10	
		60	165	15	11	1	432	24	18	1	858	33	26	1	
		90	100	10	10	-5	289	17	17	-8.5	552	23	24	-12	
2	2.5	15	120	15	8	3	390	26	15	4	756	36	21	6	
	5	15	120	15	8	3	364	26	14	5	735	35	21	7	
		30	91	13	7	2	299	23	13	3	600	30	20	4	
		45	63	9	7	1	192	16	12	1	374	22	17	1	
		60	48	8	6	-1	154	14	11	-1	270	18	15	-1	
		90	36	6	6	-3	132	12	11	-5.5	182	14	13	-6.5	
	10	30	104	13	8	4	345	23	15	5	682	31	22	9	
		45	84	12	7	1	308	22	14	2	486	27	18	3	
		60	70	10	7	-1	252	18	14	-1	396	22	18	-1	
		90	49	7	7	-3.5	2240	15	16	-8	306	17	18	-9	
	25	60	70	10	7	2	204	17	12	3	396	22	18	4	
		90	64	8	8	-4	169	13	13	-6.5	342	18	19	-9.5	
	4	2.5	15	66	11	6	2	209	19	11	3	390	26	15	4
		5	15	55	11	5	3	198	18	11	4	375	25	15	6
			30	54	9	6	2	150	15	10	3	273	21	13	4
45			35	7	5	1	108	12	9	1	192	16	12	1	
60			35	7	5	-1	99	11	9	-1	180	15	12	-1	
90			25	5	5	-2.5	64	8	8	-4	121	11	11	-5.5	
10		45	48	8	6	2	130	13	10	3	234	18	13	4	
		60	40	8	5	0	117	13	9	0	216	18	12	0	
		90	36	6	6	-3	100	10	10	-5	182	14	13	-6.5	
25		90	25	5	5	-2.5	64	8	8	-4	121	11	11	-7	
≥ 8		2.5	15	32	8	4	1	91	13	7	2	162	18	9	3
		5	15	21	7	3	3	66	11	6	4	120	15	8	6
			30	28	7	4	2	77	11	7	3	135	15	9	4
			45	24	6	4	1	70	10	7	1	117	13	9	1
			60	20	5	4	0	56	8	7	0	90	10	9	0
	90		12	4	3	-1.5	36	6	6	-3	64	8	8	-4	
	10	60	20	5	4	1	56	8	7	2	90	10	9	3	
		90	16	4	4	-2	49	7	7	-3.5	81	9	9	-4.5	

(The mounting height is the distance from the reception level and not from the floor).

9.8 Display language list

Chinese	English	639-3	639-2/5	639-1	Chinese	English	639-3	639-2/5	639-1
原声	Floor	FLO	FLO	-	爱尔兰语	Irish	GLE	GLE	GA
阿尔巴尼亚	Albanian	SQI	ALB	SQ	哈萨克语	Kazakh	KAZ	KAZ	KK
阿拉伯语	Arabic	ARA	ARA	AR	吉尔吉斯语	Kirghiz	KIR	KIR	KY
保加利亚语	Bulgarian	BUL	BUL	BG	老挝语	Lao	LAO	LAO	LO
加泰罗尼亚	Catalan	CAT	CAT	CA	蒙古语	Mongolian	MON	MON	MN
汉语	Chinese	ZHO	CHI	ZH	尼泊尔语	Nepali	NEP	NEP	NE
捷克语	Czech	CES	CZE	CS	塔吉克语	Tajik	TGK	TGK	TG
丹麦语	Danish	DAN	DAN	DA	泰语	Thai	THA	THA	TH
荷兰语	Dutch	NLD	DUT	NL	藏语	Tibetan	BOD	TIB	BO
英语	English	ENG	ENG	EN	土库曼斯坦	Turkmen	TUK	TUK	TK
芬兰语	Finnish	FIN	FIN	FI	乌克兰语	Ukrainian	UKR	UKR	UK
法语	French	FRA	FRE	FR	越南语	Vietnamese	VIE	VIE	VI
德语	German	DEU	GER	DE	粤语	Yue Chinese / Cantonese	YUE	YUE	-
希腊语	Greek	ELL	GRE	EL	克罗地亚语	Croatian	HRV	HRV	HR
希伯来语	Hebrew	HEB	HEB	HE	斯洛伐克语	Slovak	SLK	SLO	SK
匈牙利语	Hungarian	HUN	HUN	HU	斯洛文尼亚	Slovenian	SLV	SLV	SL
印度尼西亚	Indonesian	IND	IND	ID	爱沙尼亚语	Estonian	EST	EST	ET
意大利语	Italian	ITA	ITA	IT	拉脱维亚语	Latvian	LAV	LAV	LV
日语	Japanese	JPN	JPN	JA	立陶宛语	Lithuanian	LIT	LIT	LT
韩语	Korean	KOR	KOR	KO	乔治亚语	Georgian	KAT	GEO	KA
马来语	Malay	MSA	MAY	MS	冰岛语	Icelandic	ISL	ICE	IS
挪威语	Norwegian	NOR	NOR	NO	音乐	Music	MUSIC	MUS	-
波斯语	Persian	FAS	PER	FA	未知语种	Unknown	---	---	-
波兰语	Polish	POL	POL	PL	阿萨姆语	Assamese	ASM	ASM	AS
葡萄牙语	Portuguese	POR	POR	PT	巴斯克语	Basque	EUS	BAQ	EU
罗马尼亚语	Romanian	RON	RUM	RO	达里语	Dari	PRS	PRS	-
俄语	Russian	RUS	RUS	RU	宗卡语	Dzongkha	DZO	DZO	DZ
塞尔维亚语	Serbian	SRP	SRP	SR	菲律宾语	Filipino	FIL	FIL	-
西班牙语	Spanish	SPA	SPA	ES	加利西亚语	Galician	GLG	GLG	GL
瑞典语	Swedish	SWE	SWE	SV	古吉特语	Gujarati	GUJ	GUJ	GU
土耳其语	Turkish	TUR	TUR	TR	夏威夷语	Hawaiian	HAW	HAW	-
亚美利亚语	Armenian	HYE	ARM	HY	坎那达语	Kannada	KAN	KAN	KN
阿塞拜疆语	Azerbaijani	AZE	AZE	AZ	克什米尔语	Kashmiri	KAS	KAS	KS
巴厘语	Balinese	BAN	BAN	-	柬埔寨语	Central Khmer / Cambodian	KHM	KHM	-
孟加拉国语	Bengali	BEN	BEN	BN	库尔德语	Kurdish	KUR	KUR	KU
缅甸语	Burmese / Myanmar	MYA	MYA	MY	马拉雅拉姆	Malayalam	MAL	MAL	ML
白俄罗斯语	Belarusian	BEL	BEL	BE	马拉地语	Marathi	MAR	MAR	MR
科西嘉语	Corsican	COS	COS	CO	恩德贝勒语	North Ndebele / Ndebele	NDE	NDE	-

Chinese	English	639-3	639-2/5	639-1	Chinese	English	639-3	639-2/5	639-1
奥里亚语	Oriya	ORI	ORI	OR	茨瓦纳语	Tswana	TSN	TSN	TN
旁遮普语	Panjabi	PAN	PAN	PA	乌尔都语	Urdu	URD	URD	UR
罗曼什语	Romansh	ROH	ROH	-	威尔士语	Welsh	CYM	WEL	CY
梵文	Sanskrit	SAN	SAN	SA	祖鲁语	Zulu	ZUL	ZUL	ZU
信德语	Sindhi	SND	SND	SD	壮族语	Zhuang	ZHA	ZHA	ZA
僧加罗语	Sinhala / Sinhalese	SIN	SIN	SI	傣族语	Dai	DIJ	DIJ	-
梭托语	Southern Sotho / Sotho	SOT	SOT	ST	维吾尔语	Uighur	UIG	UIG	UG
斯瓦西里语	Swahili	SWA	SWA	SW	文莱语	Brunei	KXD	BRN	-
泰米尔语	Tamil	TAM	TAM	TA	北印度语	Hindi	HIN	HND (SIL14)	HI
泰卢固语	Telugu	TEL	TEL	TE					

("Unknown" will be displayed as "---" on receiver.).

TAIDEN INDUSTRIAL CO., LTD.

6/F, Block B, Future Plaza, 4060 Qiaoxiang Rd, Nanshan District, Shenzhen, China

P.C.: 518053

Website: <http://www.taiden.com>

Last Revision: 04/2023