



S SD9366-EH **S** SD9366-EHL

Speed Dome Network Camera



1080p 60 fps • 30x Zoom • 150M/250M IR • Smart IR II • IP66 • IK10 • NEMA 4X • -50°C ~ 55°C • Wiper

The SD9366-EH/EHL is the latest professional speed dome camera with wiper from VIVOTEK, specifically designed to enhance low light surveillance in large coverage areas. Equipped with 250M/150M IR illuminators and a 30x optical zoom lens, the SD9366-EH/EHL provides a superb low light image in the most challenging situations. The camera also adopts VIVOTEK's latest Smart IR II technology, Vari-Angle IR. VIVOTEK's Vari-Angle IR provides smooth vari-angle adjustment of the IR illuminators, allowing broad coverage FOV and highly uniform IR intensity while avoiding hot-spots traditionally associated with IR illumination.

The SD9366-EH/EHL is the PTZ surveillance camera with IR illumination to utilize H.265 compression technology. When combined with VIVOTEK's Smart Stream II technology users can obtain bandwidth savings of up to 80%* compared to traditional H.264. By combining 1080p full HD resolution with H.265, IR

illuminators, Vari-Angle IR, WDR, and 30x optical zoom, the SD9366-EH/EHL is able to capture fine details at top-notch quality, 24 hours a day, 7 days a week.

VIVOTEK further strengthened the camera performance with an IP66- and NEMA 4X-rated housing to protect the camera against rain, dust, and corrosion. The SD9366-EH/EHL has a wide operating temperature range from -50°C to 55°C, ensuring continuous operation under the most extreme weather conditions and hazardous environments. This makes the SD9366-EH/EHL ideally suited to monitor wide open spaces such as ports, highways, cities, and parking lots where high-level precision is required.

* Depending on scene.

Key Features

- Real-time H.265, H.264 and MJPEG Compression (Triple Codec)
- 60 fps @ 1080p Full HD
- 30x Zoom Lens
- 150M/250M IR with Smart IR II (Vari-Angle IR)
- WDR Pro for Unparalleled Visibility in High Contrast Environments
- Weather-proof IP66, Vandal-proof IK10 and NEMA 4X-rated Housing
- -50°C ~ 55°C Wide Temperature Range for Extreme Weather Conditions (AC 24V/ PoH)
- Smart Stream II to Optimize Bandwidth Efficiency
- EIS
- Easy Cleaning with Built-in Wiper

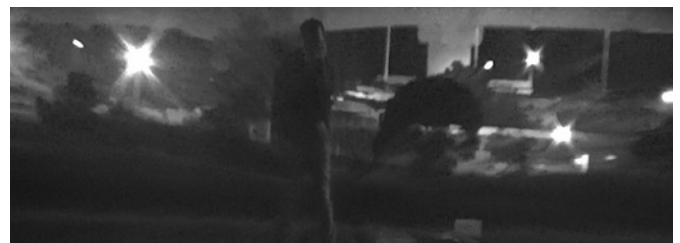

Without Vari-Angle IR



With Vari-Angle IR

Technical Specifications

Model	SD9366-EH(with Bracket, IO Cable): 30x, 250M IR SD9366-EH(without Bracket, IO Cable): 30x, 250M IR SD9366-EHL(with Bracket, IO Cable): 30x, 150M IR SD9366-EHL(without Bracket, IO Cable): 30x, 150M IR	Maximum Frame Rate	H.265 & H.264: 60 fps @ 1920x1080 MJPEG: 30 fps @ 1920x1080
System Information		Maximum Streams	4 simultaneous streams
CPU	Multimedia SoC (System-on-Chip)	S/N Ratio	SD9366-EH: 62 dB SD9366-EHL: 54 dB
Flash	128MB	Dynamic Range	SD9366-EH: 120 dB SD9366-EHL: 110 dB
RAM	512MB	Video Streaming	Adjustable resolution, quality and bitrate Smart Stream II
Camera Features		Image Settings	Adjustable image size, quality and bit rate; Time stamp, text overlay, flip & mirror; Configurable brightness, contrast, saturation, sharpness, white balance, exposure control, gain, backlight compensation, privacy masks (Up to 24); Scheduled profile settings, defog, 3DNR, EIS, HLC
Image Sensor	SD9366-EH: 1/2.8" Progressive CMOS SD9366-EHL: 1/3" Progressive CMOS	Audio	
Max. Resolution	1920x1080	Audio Capability	Two-way Audio
Lens Type	30x Optical Zoom, Auto Focus	Compression	G.711, G.726
Focal Length	f = 4.3~129 mm (30x zoom)	Interface	External microphone input External line output
Aperture	F1.6 ~ F4.7	Network	
Iris type	DC-Iris	Users	Live viewing for up to 10 clients
Field of View	2.3° ~ 64° (Horizontal) 1.3° ~ 36° (Vertical) 2.6° ~ 73° (Diagonal)	Protocols	IPv4, IPv6, TCP/IP, HTTP, HTTPS, UPnP, RTSP/ RTP/RTCP, IGMP, SMTP, FTP, DHCP, NTP, DNS, DDNS, PPPoE, CoS, QoS, SNMP, 802.1X, UDP, ICMP, ARP, TLS, NTCIP
Shutter Time	SD9366-EH: 1 sec. to 1/10,000 sec. SD9366-EHL: 1/8 sec. to 1/30,000 sec.	Interface	10 Base-T/100 Base-TX Ethernet (RJ-45) *It is highly recommended to use standard CAT5e & CAT6 cables which are compliant with the 3P/ETL standard.
WDR Technology	WDR Pro	ONVIF	Supported, specification available at www.onvif.org
Day/Night	Yes	Intelligent Video	
Removable IR-cut filter	Yes	Video Motion Detection	Five-window video motion detection
IR Illuminators	SD9366-EH: Built-in IR Illuminators up to 250 meters with Smart IR II, IR LED*2 SD9366-EHL: Built-in IR Illuminators up to 150 meters with Smart IR II, IR LED*2	Auto-Tracking	Auto-tracking on moving object
Minimum Illumination	SD9366-EH: 0.07 Lux @ F1.6 (Color) 0.01 Lux @ F1.6 (B/W) 0 Lux with IR illumination on SD9366-EHL: 0.42 Lux @ F1.6 (Color) 0.01 Lux @ F1.6 (B/W) 0 Lux with IR illumination on	Alarm and Event	
Pan Speed	0.1° ~ 300° / sec	Alarm Triggers	Motion detection, manual trigger, digital input, periodical trigger, system boot, recording notification, audio detection
Pan Range	360° endless	Alarm Events	Event notification using digital output, HTTP, SMTP, FTP, NAS server and Micro SD card File upload via HTTP, SMTP, FTP, NAS server and Micro SD card
Tilt Speed	0.1° ~ 300° / sec	General	
Tilt Range	220° (-110° ~ +110°)	Connectors	RJ-45 cable connector for Network 10/100 Mbps PoE connection*1 Audio input*1 Audio output*1 AC/DC 24V power input*1 Digital input*4 Digital output*2 RS-485 for PTZ control (PelcoD protocol, Baud rate 2400)*1
Preset Locations	256 preset locations 128 presets per tour	LED Indicator	System power and status indicator
Pan/Tilt/Zoom Functionalities	SD9366-EH: 48x digital zoom (4x on IE plug-in, 12x built-in), Auto pan mode, Auto patrol mode SD9366-EHL: 128x digital zoom (4x on IE plug-in, 32x built-in), Auto pan mode, Auto patrol mode	Power Input	PoH/PoE (95W) AC/DC 24V
On-board Storage	Slot type: Micro SD/SDHC/SDXC card slot Seamless Recording		
Video			
Compression	H265, H264, MJPEG		

Technical Specifications

Power Consumption	PoH/PoE (95W): Max. 70 W (Heater on) Max. 51 W (Heater off) AC/DC 24V: Max. 63 W (Heater on) Max. 45 W (Heater off)
Dimensions	236.45 x 364.2 mm
Weight	7.1 kg (with bracket) 5.7 kg (without bracket)
Casing	IP66, IK10, NEMA 4X
Safety Certifications	CE, FCC Class A, VCCI, C-Tick, NEMA 4X, UL
Operating Temperature	Starting Temperature: -40°C ~ 55°C (-40°F ~ 131°F) Working Temperature: -40°C ~ 55°C (-40°F ~ 131°F), DC 24V power input -50°C ~ 55°C (-58°F ~ 131°F), AC 24V/ PoH(95W) power input *Wiper is functional at 10°C to 55°C (50°F to 131°F)
Humidity	98%
Warranty	36 months
System Requirements	
Operating System	Microsoft Windows 8/7
Web Browser	Mozilla Firefox 7~43 (streaming only) Internet Explorer 10/11
Other Players	VLC: 1.1.11 or above Quicktime: 7 or above







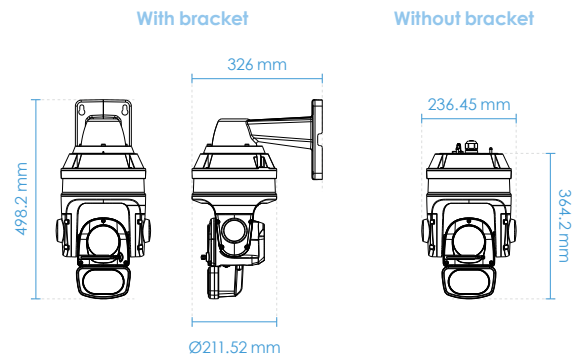















Included Accessories

CD	User's manual, quick installation guide, Shepherd, VAST
Others	Wall mount bracket*, I/O cable*, screws, waterproof connectors, terminal blocks, quick installation guide, warranty card, alignment sticker, ground wire, T25 star driver, software CD, desiccant bags *: Standard package for SD9366-EH/EHL(with Bracket, IO Cable).

Dimensions



Compatible Accessories

Mounting Kits		Others			
					
AM-220 Wall Mount Bracket	AM-529 Mounting Adapter	AE-301 Water Tank, 24VAC/DC, 0°C ~ 60°C	AJ-001 USB Joystick	AJ-002 USB Joystick	AO-007 I/O Combo Cable
Cabinet					
					
AT-CAS-001 Cabinet for Speed Dome	AT-CAB-002 Cabinet for HLG Power Supply	AT-SUN-002 Sunshield	AT-SWH-000 Power Safety Kit		
PoE Kit/Power Adapter					
24VAC			24VDC		
					
AA-341 AC 24V 3.5A Power Adapter	AA-351 Outdoor Power Box, 24VAC/144W, IP67, IK10	AA-352 Outdoor Power Box, 24VAC/144W, IP67, IK10	HLG-120H-24 Industrial 24VDC/120W Power Supply, IP67		
95W PoH/PoE					
					
AW-IHH-0100 Industrial 1xGE 95W PoH/PoE Injector	HLG-120H-54 Industrial 54VDC/120W Power Supply, IP67	AW-IHH-0200 Industrial 1xGE 95W PoH/PoE + 1x SFP GE Switch	HLG-120H-54 Industrial 54VDC/120W Power Supply, IP67	AP-GIC-011A-095 1xGE 95W PoH/PoE Injector with Surge Protection 12KV	AP-GIC-015B-095 Outdoor 1xGE 95W PoH/PoE Injector with Surge Protection 12KV, IP67, IK10