



# Garden Railroading News

Garden Railroading News No.2 Jan/Feb 2021  
A Digital Magazine

**GRNews is learning as we grow.**

Thank you to the newsletter editors who assembled many of the articles you will find in Garden Railroading News. And a big shout-out to the garden railroad club members whose tips, projects and photos become articles to share with railroaders around the world. G-Scale railroading comes in many varieties — and we wish to include ideas for experts and suggestions for those starting out by moving their “around the tree” train set outdoors.

GRNews is available to all garden railroaders by free download from our website: [www.GRNews.org](http://www.GRNews.org), and everyone can see more railroads on our Facebook Group at: [www.facebook.com/groups/gardenrailroadingnews](https://www.facebook.com/groups/gardenrailroadingnews)

Our volunteer initiative has grown to include garden railroaders around the world. We are delighted with your support and hope you enjoy this collection of articles. Please share the GRNews and spread our hobby.

**Stay on track! May your trains run on your timetable!**

# In This Issue

## Regularly Scheduled

Editor's Note	1
Seen On the Tracks: Photo Gallery	3
May We Suggest: New Products & News	4
AirWire, PIKO America, Garden Trains Annual, In Memoriam Charles F. Ro Sr.	
Straight from the Iron Horse's Mouth: Letters	40
3D Printing a Cabin, From a German Reader.	
Affiliated Clubs	41
Advertiser Index	42
Garden Railroading News Update	42

## Specials

Featured Layout: Alan & Donna Wright's Valentine & Heartland RR by Gary Woolard	7
--	---



The V&HRR Garden Guide by Alan Wright	22
Layout Preview: Nashville National Garden Railroad Convention 2021	11

## Mixed Consist Club Interchange

Thank You from the Organizers of the Nashville NGRC 2021	12
Gandy Dancers: Georgia GRS Members Winter Projects	13
Article from: Georgia Garden Railway Society Gazette February 2021	
Kitbashing Bachmann Tank Cars	16
by Howard Davis	
Article from: Tracking the Del Oro Pacific December 2020/January 2021	
Rough & Ready Sugar Cane Cars	18
by Eric Stratton Mueller	
Article from: Rose City Garden Railway Society Newsletter February 2021	
Review: Inexpensive Sound Board	20
by Chuck Carlson	
Article from: Puget Sound Garden Railway Society Garden Railroading January 2021	
Double Float Roadbed by Norm Baulinger	28
Article from: Puget Sound Garden Railway Society Garden Railroading January 2021	
Sharing a GR News Facebook Photo	30
by Louise Sewall	
Article from: Long Island Garden Railway Society Smoke & Cinders January 2021	
Animals for the Garden Railroad: Texas Longhorns	31
by Don Herzog	
Article from: Redwood Empire Garden Railway Society The Redwood Tie November 2020	
Weatherproofing Wooden Buildings	33
by Joe Hogenson	
Article from: Minnesota Garden Railway Society Newsletter January 2021	
Roadside Fruit Stand Plans by Mike Collyer	35
Article from: Central Ontario Garden Railway Assoc. Rails & Weeds Spring 2020	

All articles herein are copyright by their respective authors or club newsletters and may not be republished without permission.



Layout Design & Editor      Carla Brand Breitner  
Web Master      Mick Spilsbury

Suggestions and questions regarding the Garden Railroading News should be sent to:

Mick Spilsbury, Bay Area GRS at: [marketing@GRNews.org](mailto:marketing@GRNews.org)

Carla Brand Breitner, Santa Clarita Valley GRC at: [editor@GRNews@org](mailto:editor@GRNews@org)

Bill Derville, Organizing Principal, Rose City GRS at: [simplyGReNews@gmail.com](mailto:simplyGReNews@gmail.com)  
or [www.facebook.com/groups/gardenrailroadingenews](http://www.facebook.com/groups/gardenrailroadingenews)



Photo by Eric Blue • Blue Lantern Films

Above: *The Blue Mountain Railroad*, newly built in Atlanta, Georgia, has a scene straight out of a *Godzilla* movie. A terrifying monster, a Bearded Dragon, stopped the daily freight train as a passenger train speeds safely past. The photo proves that Model Railroading is an exciting and sometimes dangerous hobby.

Below: *The work never stops on the Tortoise & Lizard Bash Railroad.*  
*The crew at this fueling facility have their hands full.*



Photo by Todd Brody

*MAY  
WE SUGGEST...  
Something New*



## TC2300 Throttle for AirWire® Battery-Powered Wireless DCC

In mid-March, AirWire will be introducing a new OPS throttle designed to make operations easier in day, night and indoor conditions. A new graphics display, sun-light-readable black on white with backlight available when needed, shows the number, speed, direction and frequency of the active locomotive. Building and modifying multi-unit locomotive consists has been simplified. CVP Products also offers the throttle for EasyDCC and Lenz track powered systems. MSRP \$159 with charging cable & charger.

Info coming soon at: [www.cvpusa.com](http://www.cvpusa.com)

**The 2021 Garden Trains Annual** from White River Productions can be pre-ordered for \$22 through February 28; regular price \$24.95 (plus shipping, of course). The debut issue features 116 pages of exclusively large scale and outdoor railroading layouts, projects, and information. This softcover publication is dedicated to great large scale model railroading! From exciting layout tours, to gardening and plants tips, to in-depth construction and kitbashing articles, there's something for every large scale railroader.

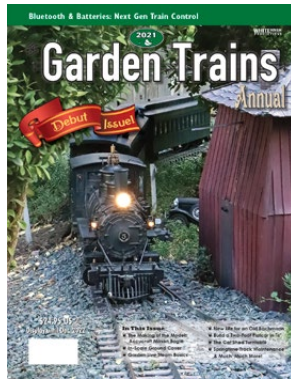

A sampling of the debut issue articles includes:

- Bluetooth & Batteries: Next Gen Train Control
- The Making of the Model: Accucraft Mason Bogie
- Build a Two-Foot Flatcar in 7/8 Scale
- Getting Started in Garden Live Steam
- In-Scale Ground Cover
- The Cat Shed Turntable
- The Garden Gallery photo feature
- And much more!

[shop.whiteriverproductions.com/products/gt21](http://shop.whiteriverproductions.com/products/gt21)  
[gardentrainsannual.com](http://gardentrainsannual.com)

White River Productions publishes multiple prototype and model railroad magazines, including *Narrow Gauge & Short Line Gazette* which occasionally features G-Scale modeling.

## Coming Soon: Constructing a Viaduct

by Bob Dransman  
from the Greater Cincinnati  
Garden Railway Society  
*The Branch Line*



## Coming Soon to PIKO America

Later this month, PIKO America will be unpacking the first of 75 new items for 2021. In addition to new catalogs, expect Deutsche Bahn Electric Locomotives, a UP Flag hopper car, PRR and D&RGW ore cars, and a Santa Fe steel boxcar. More new G-Scale product announcements will come, as well as HO-Scale North American items, later this year.



37436 DB III E94 Crocodile Electric Locomotive (decoder ready) MSRP \$959.99



37441 DB IV BR 103 Electric Locomotive (decoder ready) MSRP \$864.99



38911 PRR Ore Car MSRP \$62.99 w/lightweight ore load  
38912 D&RGW Ore Car MSRP \$62.99 w/lightweight ore load



38919 UP Flag Hopper Car MSRP \$73.99  
w/lightweight coal load



38926 SF Steel Boxcar MSRP \$93.99  
w/openable, moveable doors

Over the years, your editor has known a number of garden railroaders who have moved around the country. Most have removed their railroad before selling their home, leaving behind some interestingly shaped raised-bed planters. In this issue of GR News, you will find that two California garden railroaders are trying a different approach—sell the railroad with the house at a low-end (for their area) price to a railroad enthusiast who will enjoy maintaining an existing railroad (or two). The San Diego railroad appeared in *Garden Railways* in 2007 and the Pleasant Hill railroad appeared in 2018 and 2020. Take inspiration from the pictures and share the real estate info with anyone looking for a move-in railroad with house.

— Editor.

## Charlie F. Ro Sr. 1932–2020



Charles F. Ro Sr., founder of Charles Ro Supply Co. and USA Trains, passed away Dec. 1, 2020 at the age of 88. Charlie started selling Lionel trains in 1972, adding LGB trains when Lionel moved production to Mexico.



Charlie saw a need for G-Scale American prototype trains and started USA Trains to fill that void. Charlie promoted large scale trains at shows all around the country and was inducted into the Hobby Manufacturers Assoc. Model Railroad Hall of Fame in 2018. He helped produce numerous convention and special design cars. His enthusiasm will be missed. Contributions in memory of Charles F. Ro Sr. may be made to [www.toysfortots.org](http://www.toysfortots.org)

## Rick Blank Railroads For Sale with House in Poway near San Diego, California

**Rick Blank, former San Diego Garden Railroad Society News editor, is looking for a garden railroad enthusiast who wants to move to San Diego and take over two ready-to-run railroads.**



House

Rick writes, “We will be moving to Hawaii and I want to offer the house and railroads to someone who would enjoy and maintain the railroads. Realtors told us they would list our house on the low side at \$924,900 or 929,900. Rather than try for higher price, we would like to pass the savings on to a RR enthusiast buyer.”

Offer ends when we list our 4 bedroom, 3 bath house with a realtor in March — if we don’t get an offer from a RR enthusiast first.

Features include the railroads, beautiful mountain views and location on a quiet cul-de-sac in the highly desired Poway school district. We will sell the house to someone who will maintain the railroads for \$925,000 — and include at no extra cost the railroads, engines and rolling stock and all the items used to dress up the RRs for open houses. We will also include all tools for building and maintaining RRs: table saw, drill press, jig saw, grinding wheels and tools, parts and supplies for maintaining trains and accessories. We will cover any required inspection and real estate transfer fees. **See SDGRS.com website for photos and details.**

Contact Rick Blank at [rick.blank@att.net](mailto:rick.blank@att.net)



Patio View



Sierra Blanco RR



Regen Weissenstein RhB



# THE WORLD'S LARGEST OFFICIAL ON-LINE STORE FOR LIVE STEAM MODELS FROM THE BEST BRANDS.

[WWW.LIVESTEAMSTATION.COM](http://WWW.LIVESTEAMSTATION.COM)

## Brands

- Accucraft Trains
- Aster Hobby
- AMS (American Model Supply)
- Accucraft UK
- Accucraft Germany
- AML (American Mainline)
- Maxi-Trak
- Argyle Loco Works
- J&M Models
- Albrae Models
- O.S. Engine
- Accucraft Ride-On

## Featuring

- Live Steam & Electric
- HO, O, G-1, F and Ride-On
- Standard, Narrow Gauge & Road Engines
- Passenger Cars and Rolling Stock
- Track
- Parts and accessories



**ASTER HOBBY - LNER THOMPSON CLASS B1**  
1:32 Scale, Alcohol Fired, 4 Liveries, Kits and Ready To Run



**AML - GP60 & GP60M**  
1:29 Scale, Electric, Track or Battery Powered



**ACCUCRAFT UK - ADAMS RADIAL TANK 4-4-2T**  
1:32 Scale, Butane Fired, 5 Liveries, Kits and Ready To Run



**AML - HIGH CUBE BOX CARS**  
1:29 Scale, Metal Trucks and Wheels

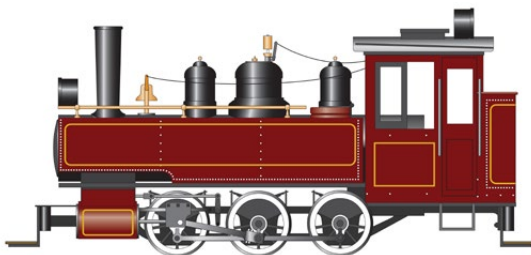

**ACCUCRAFT - BALDWIN 'MABEL' 0-6-0T**  
1:20.3 Scale, Live Steam Butane Fired, Kits and Ready To Run, R/C



**RIDE ON - 7.5" GAUGE LOCOS & PASSENGER CARS**  
1.6" & 2.5" Scale, 1" Steel Rail, Accessories



**J&M MODELS - CIWL COACHES**  
Brass Coaches in Gauge One: CIWL, L&SWR, & More

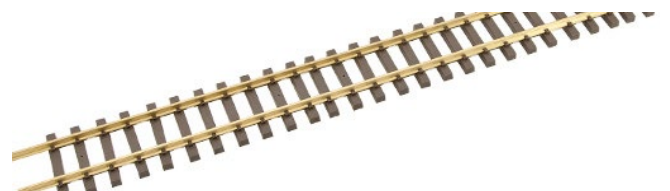

**TRACK AND ACCESSORIES**  
Code 332 & 250, Switches, Rail Clamps and more



## The Valentine & Heartland Railroad • Alan & Donna Wright, Proprietors

### Visiting The Valentine & Heartland Railroad

By Gary Woolard

Photos by Carla Brand Breitner

Alan and Donna Wright's Valentine & Heartland Railroad is an excellent garden railroad that has evolved and been maintained over 20 years.

Alan Wright bought his first engine, an LGB Mogul, in 1999. The planning began for an "L" shaped layout with a lower and upper loop along a fence and a corner of the yard, with scale landscaping to complement Donna's garden. Alan organized the Santa Clarita Valley Garden Railroad Club the next year to share his love of trains, and modeling and Donna's love of gardening.

Over the years the V&HRR has grown and changed. Alan reported on new additions, sources and maintenance tips for miniature plants that held up in a hot (and cold) high desert climate, explained track power, moved to battery-powered engines, simplified the track plan for easier maintenance, and always set out scenes of figures to populate the railroad during every Open House. He has been an exemplary garden railroad ambassador.

We first met Alan and Donna Wright viewing layouts at the Sacramento National Garden Railroad Convention in the early 2000's — or was it at a Bay Area NGRC or at the Big Train Show at the Queen Mary in Long Beach? Anyway we would exchange notes on layouts to see — and Alan would invite us to join the Santa Clarita Valley GRC. After all it was just a canyon pass away from our home in the San Fernando Valley and only thirty minutes drive, totally reasonable for the Los Angeles area where everything is at least twenty-five miles away. (Yes, the Saturday Night Live "Californios" skit is right on the mark.)

Alan arranged a pre-convention day of Open Houses before the 2004



*A logging train heads for the mill in 2006.*



*An overview of the Valentine & Heartland Railroad 2019.*

San Diego Western Regional GRC and Carla and I visited all five layouts. They were all top notch, well modeled and well planted. We joined SCVGRC that year. (As a side note, you'll meet great people at garden railroad conventions and shows. Don't be afraid to strike up a conversation about the railroads you're viewing; you might make a friend.)

Alan continues to share lessons from the V&HRR with anybody working to keep their garden railroad go-



*Alan built this replica of his dad's first business; the Westside Garage opened in Scott City, Kansas, in 1920..*

ing more than a few years. For the SCVGRC, the Valentine & Heartland has been a ‘founding layout,’ one of the few layouts shown during the 2004 Pre-San Diego Western Regional Tour which is still in place. But the layout has not remained static over the years — Alan has not been afraid to allow the layout to evolve, to adapt to changing circumstances and requirements. Some changes were part of the fight against entropy — struggles against an overgrowing tree or a leaky pond. But other changes grew out of Alan’s desire to streamline and simplify maintenance and operation of the Valentine and Heartland — the removal of an extended line of track, and very importantly, the change to battery power. Perhaps because the changes have occurred over the years, they’ve passed largely unnoticed, but they are significant.

Look at some “then-and-now” pictures which illustrate the layout’s growth and change. The top box shows the waterfall and pond. On the left as it appeared back in 2004 (yes, scanned from film!), Alan had dwarf Alberta Spruce beside the waterfall. In three years, the scene had grown, and by 2016 it had become a fully mature diorama; more climate-friendly boxwood and rosemary had replaced the Spruce.

Alan mentioned that he felt that the large wooden mill had aged well over the years, and that, too, got me looking back through Carla’s photos. Look at the middle box to see how the mill looked back in 2004 and compare it with the photo from 2018.

Perhaps the most dramatic change to the actual track plan occurred when

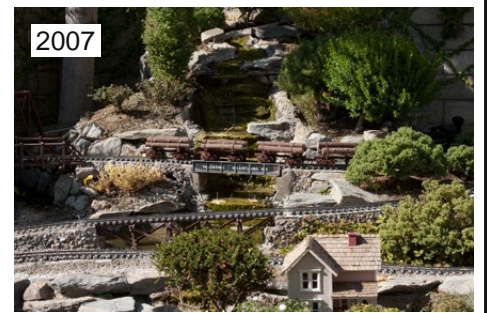
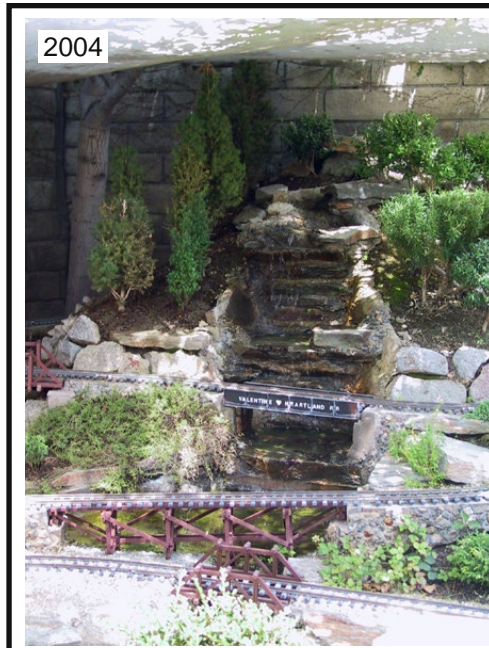

Alan decided to remove an entire leg of track. As nice as it looked in 2007, this track required a very tight turn-around, and became problematic. By 2016 Alan had taken it out and replaced it with the town and road below.

Two lessons can be learned from this then-and-now look at the Valentine & Heartland. One is that you

shouldn’t be afraid to change your layout to accommodate new ideas and circumstances. The other one, as I’m sure Alan will endorse, is that a garden railroader’s work is never done. Maintaining your layout requires constant attention and effort.

Hats off to Alan and Donna for their love of garden railroading.





# A Gallery of Details on the Valentine & Heartland Railroad

Photos by Carla Brand Breitner



For more on the miniature plantings on the V&HRR, see the V&HRR Garden Guide on pg. 22



Limited-Edition

# LGB® Garden Railroading

Get on board and join the fun!

Locomotives are partially chrome plated to replicate the stainless-steel on the actual locomotives. The galvanic chrome plating process is done by hand and involves nearly 40-steps. It is the same process used in the automotive industry.



20582 Santa Fe F7B Diesel Locomotive



20581 & 20583 Santa Fe F7A Diesel Locomotives, different road numbers



20587 Santa Fe F7B Diesel Locomotive



20585 Santa Fe F7A Diesel Locomotive

A complete Santa Fe "Super Chief" can be assembled using LGB streamliner cars (Nos. 36567, 36568, 36569, 36578, 36579). All cars have interior lighting, complete interior details and metal wheelsets.

LGB is offering a limited-edition Club model for North American LGB Club members only. Santa Fe F7 "Yellow Bonnet" (Item# 20584). The locomotive is partially chrome-plated to show the original locomotive's stainless-steel look. **Only 80 pieces available!**

*For more information on joining the LGB Club, visit [LGB.com](http://LGB.com)*

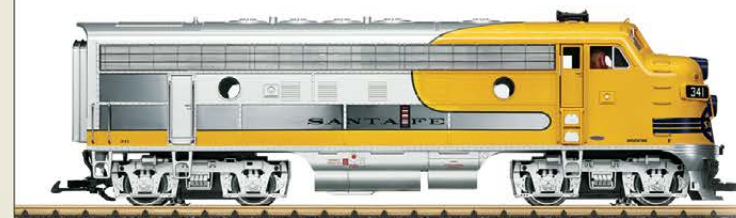

## Join the Club!

- Subscription to LGB Depesche magazine
- Access to annual Club model
- 2 Annual Videos – A Year with LGB
- Special offers and more!

# 36th National Garden Railway Convention • Nashville 2021



**May 30–June 5, 2021**

**Make plans now to attend and support garden railroading.**

Carter and Patsy Johnson  
Tuesday June 1, 2021

**Small Town USA** | The indoor layout is 18' x 20' in size with 150' of brass track and uses DCC. It is inspired by a 1960's small town, similar to any found throughout the USA. Lots of vehicles, figures and buildings show tons of detail. There are operating traffic lights and five bridges including various scenes that include a classic car show, a band playing in the park, mechanics working at a garage, and a drive-in hamburger joint. A typical town square anchors the layout. You'll be surprised at the disappearing mountain



**Evergreen Line** | The outdoor railroad is located on a 10' x 60' raised planter consisting of mostly evergreen shrubs. The layout has 140 feet of brass track with a 10-foot-long tunnel and seven-foot-long bridge. The trains are battery powered.



**Nashville will host the 36th National Garden Railway Convention in 2021.**

Updated information is at the website: [www.ngrc2021.com](http://www.ngrc2021.com)

Nashville GRS has sent out a few layout descriptions with photos to tempt us to come to the 36th National Garden Railway Convention in late May and early June. Registering early will help them stay "on track."



The 2021 National Garden Railroad Convention car, produced by USA Trains, is now available for pre-order in two road numbers—2020 or 2021. To reduce financial risk, there is a **February 22nd** deadline to place orders for a minimum of 150 cars or no cars will be produced. The price of the cars is \$85. Shipping for 1, 2 or 4 cars for \$12 is being negotiated for those who cannot attend. Convention cars can be purchased using the Convention website; [www.ngrc2021.com](http://www.ngrc2021.com).

Walter Ethridge  
Tuesday June 1, 2021

**Walter's Midway** | This layout was built by my very best friend Carter Johnson at his house. I never had a chance to have an outdoor layout. When I got out of the Air Force, I worked at a local amusement park in Nashville called Fair Park. I was the manager of the roller coaster for three years and this layout with all of the rides takes me back to the times when I smiled and laughed at other people having fun because of something I did. The layout has 140 feet of track and is track powered. At the amusement park, there are 14 animated attractions and four which are unanimated.



Steve and Malinda Jungst  
Wednesday June 2, 2021

**J2A Railroad** | With two mainlines consisting of separate loops totaling 370 feet, this track-powered railroad has three bridges and three trestles. Lengths of the trestles are 7.5, 8 and 24 feet. Many scenes are rural America and agricultural related. Several buildings have been scratch-built or kit-bashed. Numerous varieties of plants and ground cover are used on the layout including 14 dwarf and miniature Japanese maple trees.

William and Bettye Heald  
Thursday June 3, 2021

**Colorado Memory Line** | This railroad, with approximately 100 feet of brass track on the first loop and another 60 feet on the second loop, dates back to the early days of the Nashville Garden Railway Society. Different Colorado narrow gauge railroads between 1880 to 1930 are represented. Trains are battery powered. The layout is approximately 50 feet x 50 feet with a 10-foot-long curved trestle and four tunnels demonstrates what can be done with a limited amount of space, limited funds, and modest modeling skills. The station in the photo is scratch-built as are the numerous stores in the town scenes.



email: [ngrcnashville@gmail.com](mailto:ngrcnashville@gmail.com) • website: [www.ngrc2021.com](http://www.ngrc2021.com)

Vendor hall: Steve Jungst (615) 674-8281 • Hotel reservations: (877) 351-5021 (Request NGRC convention discount.)

# Thank You: An Open Letter to Our Fellow Garden Railroaders

On behalf of the Nashville Garden Railway Society and the 2020 National Garden Railroad Convention Organizing Committee we would like to extend our sincere appreciation to all of our fellow Garden Railroading friends for their patience and understanding as we continue to manage our way through the many challenges the COVID-19 pandemic has brought on all of us in 2020. We are deeply disappointed the 36<sup>th</sup> National Garden Railroad Convention had to be postponed, but with a vaccine for the virus on the horizon and new therapeutics, we are looking forward to better days ahead and hosting the convention in 2021.

With approximately 300 registrations for the 2020 national convention, it took us many hours to reach out to everyone to confirm whether to transfer their registrations or issue refunds. Thank you for your patience. To all the vendors that stood beside us and transferred their booth spaces from 2020 to 2021, we appreciate your continued support. To the Denver Garden Railway Society and the Bay Area Garden Railway Society, thank you for your willingness and coopera-

tion in sliding the dates for hosting the next two conventions back by one year to allow the Nashville Garden Railway Society to host the convention in 2021. We know both clubs were well on their way making plans to host their conventions. For all of our colleagues that purchased a 2020 National Garden Railroad Convention car, thank you and we hope you are enjoying the cars. We would like to acknowledge the assistance of several people who organized bulk purchases of convention cars by contacting their club members. To Mick Spilsbury, Colin Camarillo, Richard Friedman, Mark Edwards, Roy Williamson, Dwight Malott, and Robby Dascotte from RLD Hobbies, we are sincerely appreciative for all you have done.

Again, thank you to all of our friends and colleagues in this great hobby for your support and understanding. We look forward to seeing everyone in Nashville, TN from May 30 to June 5, 2021.

Kenneth Miller, President  
Nashville Garden Railway Society  
Steve Jungst, Vendor Hall Chairman

**EggHaulers.com**



Looking for something to tow behind your Eggliner?



Laser-cut Wood Doors, Windows, & Accessories at Affordable Prices!  
Semi-custom design wizard online

**ECKARDT DESIGN LLC**

www.eckardtdesign.com

## Nancy Norris RR For Sale with House in Pleasant Hill near San Francisco, California

[Real Estate Advertisement]



### Garden Railway Sale Coming Soon! *Yes, you must buy the home to buy this garden railway on three sides of the house.*

In peaceful Pleasant Hill, California, Nancy Norris is selling her ranch house of 1,385 sq. ft. on 0.226 acre (over 1/5 of an acre). The railway — all 45mm (large scale) track — goes through a storage shed caboose and was first shown at the 2016 National Garden Railway Convention. Numerous sitting areas joined by paver pathways allow roomy conversation areas or hobby-building spaces, both shady and sunny. Pick year-round fruit from over 22 fruit trees. A small greenhouse is wired and plumbed. Many fun extras.

Contact Nancy at 925-408-9402 for pricing and a March sale.

Live steamups have been run for the past five years on approximately 300 linear feet of raised track. Track is not electrified, but suitable for live steam or battery powered engines. Track spaced out over a large area allows concurrent running of multiple trains and a very active open house. Pathways afford train/track access to a cog railway and two other lines. Consists can be set up on ready tracks in the caboose.

For more, see stories in Garden Railways magazine [grw.trains.com](http://grw.trains.com): Dec. 2018 (caboose) and Feb. 2020 (7/8th" railway and edibles).



**Theme for the Month - Cold Weather Projects**

Members were asked to send in their 2021 cold weather projects.

**Gandy Dancers**

Highlighting Members and their work



My winter project has been collecting (over the years of Prescriptions) the little canisters of silica gel inserted into medications, vitamins, and supplements. These are almost the right size for G scale oil cans, grease tubs, and really require very little work. - Emil Decker

- 1) Save them up.
- 2) Paint the top and bottom a silver color.
- 3) Create labels that wrap around the circumference. Images of old petroleum cans are all over the internet. Just google the ones you want to use. Trial & error or do the math on size.
- 4) Cut and glue the labels onto the cans.
- 5) Seal with dulcote to protect the paper wrap against weather, or replace as needed.



**STEAM IN THE GARDEN**

**Starting in STEAM** is the definitive handbook for those just starting in Small Scale Live Steam. Available in digital format, you can take this with you on your laptop or tablet. Assembled from articles in *Steam in the Garden*, this 148-page book not only introduces new hobbyists to the fun and excitement of small-scale live steam, but will also provide experienced steamers with tips and tricks from seasoned hands. Buy your digital copy of *Starting in STEAM* today. <http://www.steamup.com>

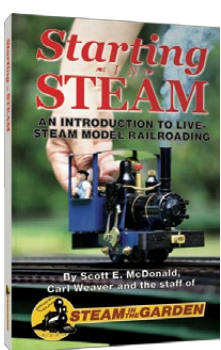

**IF YOU CAN DREAM IT WE CAN BUILD IT**

[WWW.JSWOODCRAFTS.NET](http://WWW.JSWOODCRAFTS.NET)

Structures, Animation, Motorization, Accessories, Diecast, Custom Freight Cars, Custom Work and more.

All structures and accessories are 1/2" scale • 1/24th, G-Scale compatible.

e-mail: [jswoodcrafts@sbcglobal.net](mailto:jswoodcrafts@sbcglobal.net)  
310-539-44246 P.S.T. All Week 10 to 5 P.M.

**G Scale Graphics**

2.4 GHZ Radio Control  
**RailBoss 4 R/C**

**Battery or Track**

All the Features you Expect and More !

**Sound Clip Modules**



**Battery Conversion Modules**  
Reduced wiring for any battery installation

- ★ New for Track Power
- Back 'n Forth Trolley
- All Purpose Train Control
- Track Pack
- No Frills Track Throttle

North American Distributor for **from \$89**

**MyLocoSound**

Steam - Diesel - Electric  
Goose - Street Car

Battery R/C or Track Power  
Trigger via R/C, TV Remote or Track Magnets

**Custom Vinyl Lettering**

[www.GScaleGraphics.net](http://www.GScaleGraphics.net)  
Del Tapparo GScaleGraphics@comcast.net 970-581-3567

**Theme for the Month - Cold Weather Projects**

*Members were asked to send in their 2021 cold weather projects.*

**Gandy Dancers**  
**Highlighting Members and their work**



With the Colorado Railroad Museum completing restoration of Rio Grande Southern 4-6-0 in August of 2020, I decided I would try to recreate the loco in G-Scale. I started with a Bachmann 4-6-0 RGS #25. I changed the cab to the wood style, changed road numbers and added other lettering to cab bottom. Hungry boards were added to tender as was an air tank. Spark arrestor was made from hummingbird feeder bee guard. While not an exact replica, I enjoyed the project. Compare the two photos.

- Ted Yarborough



**FAMILY OWNED SINCE 1995**  
**5-YEAR WARRANTY ON ALL PRODUCTS**

**CONTACT US AT:**  
**BRIDGEWERKS.COM**  
**253-225-9032**

**SINGLE TRACK POWER OPTIONS IN 3, 5, 15 AND 20 AMPS**  
**CONTACT US AT BRIDGEWERKS.COM FOR 220V OPTIONS**



# CANADA'S FAVOURITE G-SCALE TRAIN STORE



Located in the Great White North (Guelph, ON), Winona Garden Railway is your one-stop shop for large scale trains, radio controlled products (RailPro™. and Revolution™) battery power conversions, and sound installations.

Offering a large selection of G-Scale trains and accessories, We help you make your layout dreams a reality.

For product pricing and exclusive offers, **contact us today:**

[www.wgrr.ca](http://www.wgrr.ca)  
[john@wgrr.ca](mailto:john@wgrr.ca)  
1-519-763-9477

## WINONA GARDEN RAILWAY EXCLUSIVE ALCO S4 CANADIAN NATIONAL SWITCHER #8152

### ARE YOU ON THE LIST?



Calling all Canadian road name fans, We are currently offering this limited production CN Railway Alco S4 — **only 50 locomotives in production** — order yours today before they're gone!

AUTHORIZED RETAILERS OF:



*Limited Production - 50 Locomotives*

- 1:29 Scale
- Dual Motors
- Opening doors
- Fan driven smoke exhaust
- Lighted cab interior with engineer
- Lighted number boards
- Operational directional headlight
- Metal handrails
- Highly detailed graphics including builders plate

[www.wgrr.ca](http://www.wgrr.ca)

**Reserve Today**



## Projects, What's Coming Up, Things to check out

Howard Davis is quite the builder and kit basher. Howard sent me some pictures of tank cars he has been working on. He also sent me some info on how he constructed the cars.



The tank cars pictured are kit bashing projects of mine. They are all done by using Bachmann tank cars. The double dome tanks obviously use two cars. Once you do a few of these projects, you will end up with more tank car pieces and you can make a longer single dome or a shorty. Be creative; kit bashing is fun!

Once the tanks have been re-positioned and glued in place, spray paint first with primer then the appropriate color. Lettering on these cars is from K-4 Decals. Add some detail parts and metal wheels. The standard Bachmann tank car has a tank close to 14" long. If you make a longer tank, say one of the fairly quick double dome tank cars, at 17 1/4" long, you have added 3 1/4". Since all measurements are relative, you simply have to create a floor and a frame 3 1/4" longer. Whether you are kit bashing a single dome, double dome, or a shorty, make the tank first. It is a lot easier to make an adjustment in length of the floor rather the tank. The floors have been augmented by gluing wooden coffee stir sticks to the plastic floor.



Thank you for this wonderful article, I'm ready to go work on tank cars now!

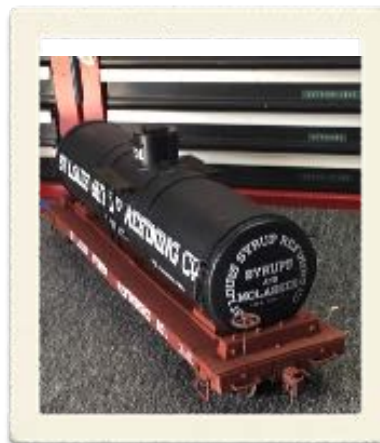



**DWARF & MINIATURE PLANTS MEAN MORE TIME TO RUN TRAINS**



**www.miniforest.com**  
 Order online or in person, visitors welcome by appointment 503 632 3555

**Valley Train Station**

13780 Pipeline Ave  
 Chino CA 91710

**Phone: 909-902-5351**  
**FAX: 909-902-5352**

Hours: 10 to 6 Tues-Sat

**G Scale Only!**  
**Slot Cars too!**



**EAGLEWINGS IRON CRAFT**

"Spend wisely buy only once!"



*Built To Last*

[www.eaglewingsironcraft.com](http://www.eaglewingsironcraft.com)

**BRIDGE MASTERS**

[www.bridge-masters.com](http://www.bridge-masters.com)

**Track Cleaner**  
 Goes around 1100 curves and switches.  
 Scotchbrite™ abrasive pad is replaceable.  
**\$95.00 including priority shipping**



**Additional Products:**  
 Culvert Bridge • Sub-Supported Bridge • Telephone Poles •  
 A-Frame Bridge • Right-of-Way Signs • Retaining Walls •  
 Brass Structure Lights • Warren Through Bridges • Portals/  
 Abutments • Modular Deck Trestles (straight & curved) •  
 Windmill • Bumpers • Coal Bins • Tank Stand •  
 Loads • Sheds • Platform Dock Set • Fencing

*All products are pre-assembled with nails and are dark semi-transparent stained.*  
 Send us a large SASE for complete product line and pricing.  
 22626 Manalastas Dr, Lake Forest CA 92630 (714) 985-9007

Serving You Since 1981 with over 65 products

**Gary Raymond Metal Wheels**

Upgrade to higher quality wheels!

**Easy Installation**

**Reliable on all large-scale track**

PO Box 1722-N, Thousand Oaks CA 91358  
 805-492-5858 • M-F, 9-5 PST

[www.trainwheels.com](http://www.trainwheels.com)  
[ggraymond@earthlink.net](mailto:ggraymond@earthlink.net)

NOT ALL METAL WHEELS ARE CREATED EQUAL™



## Sunset Valley Railroad LLC

Complete line of code 250 track in brass, aluminum, nickel-silver and stainless. Connects to code 332 track. G gauge (45mm) O gauge and dual gauge available. 49 sizes and styles of switches and crossings. Comprehensive pneumatic switch operating system, very simple and reliable to install and use! Experienced dealer for Accucraft/Aster and Roundhouse. In business for 30 years. Nearly everything proudly made in the USA.



Pneumatic switch



G gauge track

We carry over 20,000 ft of track and 300 switches in stock for YOUR garden railroad

Call 253-862-6748 [www.sunsetvalleyrailroad.com](http://www.sunsetvalleyrailroad.com) email [pete@sunsetvalleyrailroad.com](mailto:pete@sunsetvalleyrailroad.com)

## Beginner / Budget Project: Rough & Ready Sugar Cane Cars

Last month (January 2021 RCGRS Newsletter) featured an introduction to the Mueller's', a new member family and their garden railroad the Triple O. This is a follow-up article on how they build their Sugar Cane Cars.  
By Eric Stratton Mueller

Aloha again from the crew of the Triple O! Our Hawaii inspired garden railroad has two DC analog loops, with the outer loop nominally representing the real Oahu Railway & Land Co. and the inner loop nominally representing any of the sugar plantations along its route.

Last year, we decided we need a string of cane cars for the fictional M&K Sugar Co. to better fix the Triple O in time and place. A helpful donation of 1/2"x 1/2" strip lumber, spare wheelsets, and hook and loop couplers from an on-line "pen pal" forced us to go from thinking to doing. All projects begin with research. Photos in books and on the internet showed that each plantation answered the problem of hauling cane from field to mill a bit differently, but we wanted to at least draw from a local real-world example. We took measurements from a cane car on display at the Hawaiian Railway Society, one of the last of hundreds if not thousands of similar cars



Prototype Inspiration - 2' gauge US Navy mining 1 car from inter-War era projects

that once served the islands. We also photographed and measured maintenance of way cars and even the Navy's old mining equipment for ideas. In the end, we settled on a simple design that took from all the prototypes, as each offered an idea that was



Tape Before Glue - Testing an Early Prototype-1

"true to the spirit" and within our capabilities. The resulting design was 5" long and 3" wide across the end beams. We placed two lengthwise members so that the journals would line up over the rails, and we ran a third down the center for strength and to serve as a mounting point for the couplers. For reasons of simplicity and cost, journals are half-inch-long blocks



Crafting the Hold Down Chains

Continued on next page



with 3mm grommets glued into the holes. Each wheel has a washer glued behind it to add weight to the car. Craft sticks provided decking and bulkhead walls, 1/8"x1/8" basswood strips served to support the bulkheads, and jewelry chain became hold-down chains. Shish kabob skewers painted black became truss rods. I elected to leave off brakes, as these were not universal, as well as nuts and bolts, as these would've added unneeded complexity. We used TiteBond III throughout. Screws hold the couplers in place, and small nails hold up the end posts.

Though local can companies seemed to have painted their cars dark green, we all liked the plain wood look. A fine tip pen provided "nails," they all got a quick turn under the Dremel for wear followed



More than Sugar (2) - The Crew Has Fun with the Basic Design  
2020 8 31 16 43

PLAYMOBIL. We also used the design to make a simple gondola as a transition car for our Eggliner. "Craft stick" modeling may not be for every taste, but hopefully our experiences will provide ideas for your light industrial cars or entry-level projects for junior railroaders of all ages!



Completed Car Ready for the Harvest



The Oma Bea Liner Gets a Custom Gondola to Serve as a knuckle Transition Car-to-hook-12 20 17 37 and-loop

by a wash of diluted India ink. In the end, we had a nice string of custom cane cars! Having validated the basic design, we intended to make a string of service cars using the same chassis. Instead, when COVID hit, I created kits for the four crewmen with instructions that the car only had to be in scale with

Many thanks to the members of Large Scale Central (<http://largescalecentral.com>) for many of the ideas that brought these cars to life!

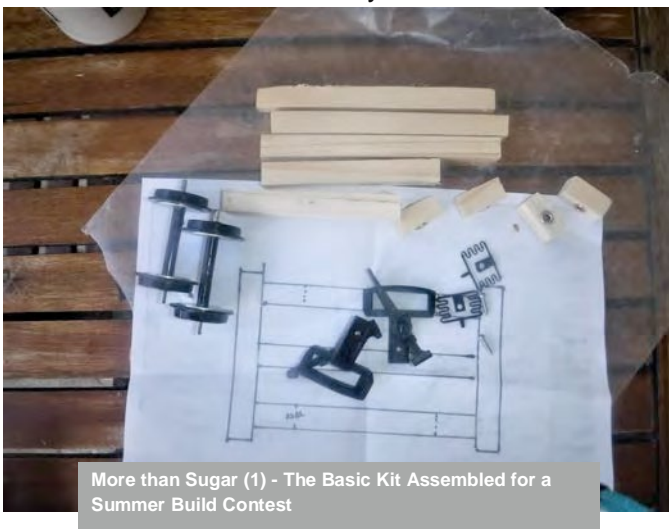

More than Sugar (1) - The Basic Kit Assembled for a Summer Build Contest



Komaka Iki (A Stainz - LGB 2075 hybrid) pushes homemade cane cars



## Inexpensive Sound Board

Photo and article by Chuck Carlson

For many years we had to rely on the Phoenix sound system to receive that steam or diesel sound that matched the era or engine we own. Also, to get that gas engine sound for our goose or railbus. Phoenix sound systems can cost as much as \$349.00 each.

Now there is an inexpensive Sound system that some of you know about and some don't. This article is primarily addressing those that have not heard of or know little about the Loco Sound System. Their distributor is G Scale Graphics, owned and operated by a real nice guy name Del.

I first came across Loco Sound board when I was looking for a gas engine sound for my new Southern Pacific Railbus. I had been buying G Scale Graphics battery conversion boards for many years and when Del sent me an Email about Loco now having a gas engine sound for an amazing price of \$79.95 (Loco Sound system also has sound for steam and diesel.). I had to have it. Big problem though: the demand was so high that my hesitation in buying cost me months of waiting.

One of the features of the Loco board is that it works with several of the RC boards on the market. I personally use the Revolution Train Engineer and if you are also a Train Engineer user, you know that seven wire connector that you never use, well that connects to the Loco sound board.



As you can see from the picture above, the sound board is smaller than the Revolution receiver board and uses all seven leads from the Revolution auxiliary plug. It plays the gas engine trying to start up, running, horn, bell, all aboard, and braking sound. By using a universal TV remote set to 0149 you have access to seven different goose engine sounds, increase the volume and change function keys. With the Revolution Transmitter, you use keys 1-7 to play the sounds. The sound board has an IF receiver for the remote and comes with an external IF plug if the board is not visible to the remote. The other thing you need is an 8 ohm 2 watt speaker.



## WifiTrax

### Walk-around Wi-Fi Control for your Garden Railway

- Wi-Fi/DCC controls your locomotive using your existing DCC Decoder!
- Dead-Rail Solution—Install WDMI-27 in your battery powered large-scale loco together with your chosen DCC Decoder
- Drive trains using popular Engine Driver app on Android, WiThrottle on Apple or use the TCS UWT-100

[www.wifitrax.com](http://www.wifitrax.com)

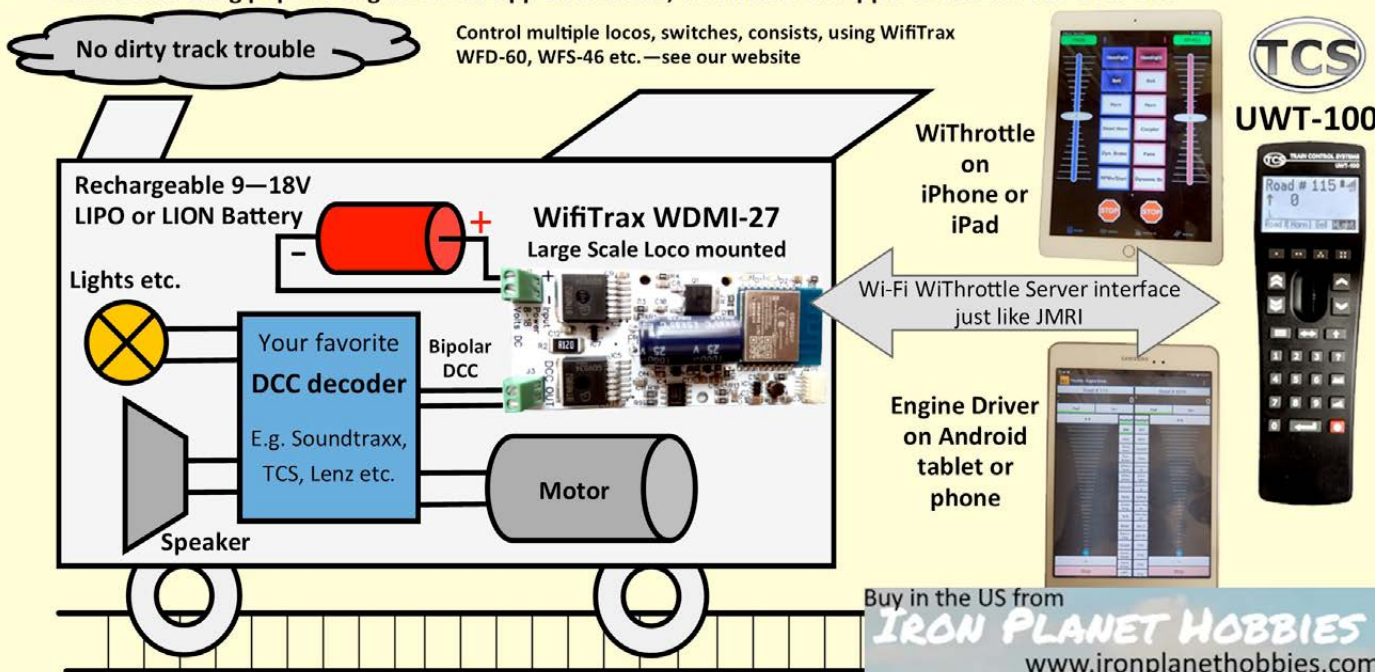

or buy direct from: [www.wifitrax.com](http://www.wifitrax.com)



NATIONAL GARDEN

MAY 30 through JUNE 5

2021

RAILWAY CONVENTION



Nashville, TN  
Gaylord Opryland Resort

May 30–June 5, 2021

Included with your Friday Banquet Event Ticket...

- Country Music Recording Artist Irlene Mandrell



- The renowned 12 South Band



"2021 Convention Car Available by Pre-Order Now!"

- Designed by NGRS and produced by USA Trains.
- Two road numbers—2020 & 2021—available. **Order TODAY!**
- Check deadline and shipping details at [www.ngrc2021.com](http://www.ngrc2021.com)

BULKEND FLATCAR WITH TANK



36th National Garden Railway Convention  
Presented by the Nashville Garden Railway Society

[ngrc2021.com](http://ngrc2021.com)  
Registration is open

## The Valentine & Heartland RR Garden Guide

### Adding The “Garden” To Our Garden Railroad

by Alan Wright

Photos by the Author except as noted

Depending on how much you want to put into them, garden railroads are a lot of work. Those of us who choose to include a substantial amount of landscaping with plants and water features have to accept the responsibility of maintaining those features on a regular basis. This article is about what worked and what didn't, and my attempt to reduce the *effort* spent maintaining the Valentine & Heartland Railroad, our garden railroad layout.

This is not intended to be a “how to” article, but to represent my experience with plants, pond and waterfall on the layout and how it has finally turned out. I will try to show how trial and error helped to shape the current results, realizing that it is an on-going effort.

When Donna and I married in 1998, her home already had a well-established garden with walkways and a gazebo on this large flag lot. A co-worker at Disney got her interested in a garden railroad and she asked me if I was interested. I couldn't wait to get started! She assumed it would simply be a “train running through the garden” but, of course, I had far grander ideas. I did, however, feel that the inclusion of a lot of plants on the layout would complement the rest of her lush, informal garden.

We added phase II to the layout starting in 2003, which almost doubled the size of the layout. The club hosted public open houses in 2004 and 2005 and we participated in both. The photo below shows how it looked at that time when quite a few trees had been added. Most of these are still on the layout.



### SOURCING OUR PLANTS

In the years that followed we picked up plants at the Big Train Show and various Garden Railroad Conventions. While several did not survive, we still have a couple which are favorites of mine. The lone Hokkaido Elm has done well in one of the few areas with pre-



*The grassy area between the edge of the walkway and the concrete block perimeter wall was selected for the layout. Even on this side of the house, the ivy on the wall, large shrubs and roses along the walk contributed a great background for the layout.* 9/7/1999



*This photo shows a view from the other direction eight months later. Aside from the lawn, all of the existing plants and two trees have been retained. The road-bed is cast-in-place concrete. Top soil is being added. The existing graded site was composed of a lot of clay mixed with rock, common in this area and not ideal for planting.* 5/12/2000



*Almost two years later the planting is emerging, with some trees at the far end and creeping thyme ground-cover on the bank between the tracks. The hill with the waterfall also has been planted with trees.* 3/30/2002

## The Valentine & Heartland RR Garden Guide continued

### PARTIAL PLANT LIST - TREES & SHRUBS Valentine & Heartland Railroad

- African Boxwood** *myrsinaceae africana*  
Full sun, partial shade, up to 8' if not pruned.
- Japanese Boxwood** *buxus microphylla japonica*  
Full sun or shade, takes dry heat & alkaline soil.
- Dwarf Pomegranate** *punica granatum nana*  
Sun, evergreen thru mild winters, flowers, fruit.
- Box Leaf Euonymus** *euonymus japonica pulcbella* — Full to partial sun, slow growing to 2' tall. A variegated variety is often available.
- Rosemary** *rosmarinus officinalis prostrates*  
Sun, tough, little water, to 2' tall, spreads.
- Dwarf Myrtle** *myrtus communis compacta*  
Sun, partial shade, compact, small leaves.
- Rock Cotoneaster** *cotoneaster horizontalis*  
Full sun, little water, up to 3' if not pruned; red berries provide apple tree look.
- Hokkaido Elm** *ulmus parvifolia seiju*  
Sun & some shade. This is a Bonsai plant; prune to shape.
- Dwarf New Zealand Tea Tree** *leptospermum scoparium* — Full sun, little water requirement.
- Japanese Juniper** *juniperus cupressaceae procumbens "nana"* — sun part shade, about 12" high & spreads, can be staked to more upright.
- Miniature Roses**, plant size is 12" to 18", plant in sunny spot, good air flow, nutrients, pest control and regular pruning. Select tree rose for variety.
- Lemon Thyme** *thymus citriodorus*  
Full sun to light shade, tiny leaves and knurly trunk.
- Small shrubs** which I am unable to identify but they look good. Only a few have survived.
- PARTIAL PLANT LIST—GROUND COVERS**
- Ice plants, sedums**, various varieties  
Some have been in place for a long time. Cut back when they intrude onto the track.
- Dymondia** *dymondia margaretae*  
An evergreen perennial, takes full sun, tight mats, 2 to 3" deep; spreads slowly by offsets. Can take light foot traffic.
- Ornamental grasses** Used between two parallel tracks and stand-alone locations.

dominant shade surrounded by a field of Baby Tears. Five Dwarf Pomegranates continue to thrive as stand-alone trees. These are really great garden railway plants with lots of color; they take pruning well and seem to thrive in our hot climate.

At a specialized nursery in Paso Robles that featured lots of hard-to-find herbal plants and similar types of small plants, we chose from a large number of varieties of Thyme and brought a lot of them home to put on the layout. Only a few now survive.

After a while it became apparent that it would be more convenient and cost less to shop locally for our plants. This has the added advantage of assuring that the plants will tolerate the extremes of our local climate.

### HOW ABOUT OUR CLIMATE

The Sunset Western Garden Book has described climate zones that are much more useful than the USDA maps. My book is a little old (7th printing 1998) and may not recognize our hotter and longer summers, but it continues to be a good guide to see what plants are likely to do well and survive. Their map indicates that the Santa Clarita Valley is in Zone 18 and the San Fernando Valley has both Zones 18 and 19. Both zones are very little influenced by the ocean and differ in their averaged lows of 28 to 10 degrees F. for Zone 18 and 27 to 22 degrees F. for Zone 19.

### WHAT DO I LOOK FOR IN MY NURSERY PLANT?

Even if you are buying a traditional hedge plant, you should look at all of the stock and select those that will make a good scale "tree." Multiple trunks or stems generally are a problem. Ideally you want a single strong trunk with the branches starting at a reasonable height. Plan to cut off anything that is below that. While it is nice to have the leaves small and close to scale, if the plant meets your other criteria a larger leaf is OK. Slow or fast growing? Remember you will be trimming this plant periodically throughout its life on your layout to keep it from getting too large.

The layout looks much nicer if you use groundcovers to fill in bare spots. At the beginning we found Wooley Thyme and Elfin Thyme to be very attractive. After several winters, the Thyme did not look good, with lots of brown thatch. Donna added a small leafed ice plant in several places and this fills in rapidly, stays green all year and produces colorful flowers. It can easily be trimmed to keep it away from the tracks, however it is largely out of scale. The ice plants also damage badly if you step on them.

A few years ago we bought groundcover plants marketed by Armstrong Nursery as "Stepables." We planted it in a place where frequent access was required and after it got established, it lived up to its reputation to allow occasional foot traffic without damage. The name of the plant is **Dymondia** and when I downsized about a year and half ago, it was planted in many flat and sloped areas with great success. During the drought it was one of the plants listed by our Water District as a water-wise lawn substitute.

## The Valentine & Heartland RR Garden Guide continued

### WATERFALL AND PONDS

The waterfall and adjacent lower pond were constructed in Phase I. In Phase II a large pre-formed plastic pond was installed and the stream bed from the waterfall was extended to the new pond. This provided a river for the new bridge to cross. (We won this bridge at the 2003 Sacramento National Garden Railway Convention.)

Water features can add a lot of interest to any layout. We tried to keep it simple, but had problems when I hurried the waterfall construction. Unfortunately we discovered that it leaked. Sealing the cement and rock joints did not correct the problem. Apparently the membrane laps underneath were allowing water to escape. I rejected doing a complete removal to fix the problem and instead built a bypass to direct the leak back into the small pond.

### MAINTAINING THE RAILROAD

Four years ago I made a decision to make changes in my layout so it would be easier to take care of. I hoped this would add to a greater enjoyment of what I had. I removed about a third of my track, eliminated one tunnel and relocated my buildings to make them all easily accessible. Several years before, I converted some engines to battery power, so clean track was not a requirement. All of my major plants, many over fifteen years old, were left in place and ground covers added where needed.

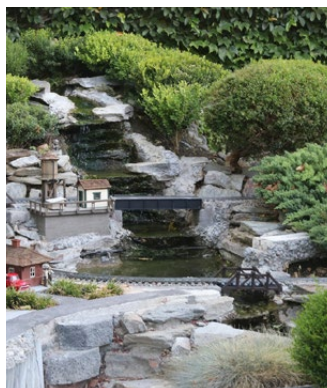
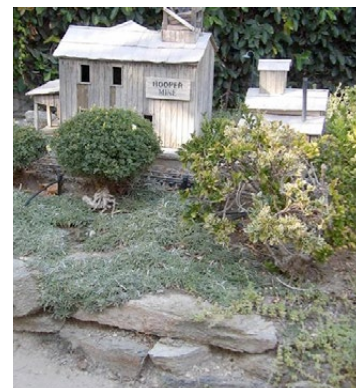

Photo by Carla Brand Breitner



These Dwarf Pomegranate have been trimmed using the grass clipper. Trimming under the canopy is for clearance.



Left: Dymondia, a stepable groundcover with Boxwood tree to the left and a New Zealand Tea Tree on the right in the shade.



Left: Lemon Thyme. Has interesting knurly trunk. This one is about sixteen years old.

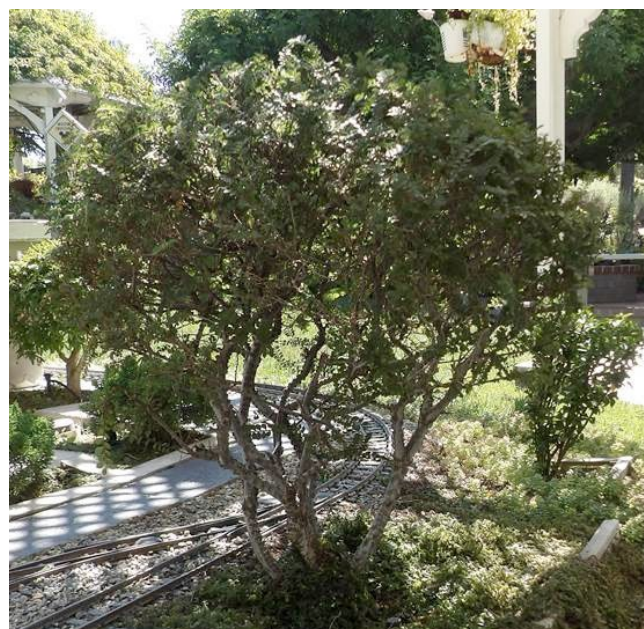

Above: Hokkaido Elm. This tree has recently been pruned and opened up. It was planted a little too close to the tracks and the lower areas have been trimmed more to allow clearance.



## The Valentine & Heartland RR Garden Guide continued

### HERE IS WHAT I AM TRYING TO DO

1. Plants need regular care so I work for an hour or so once or twice a week for routine maintenance.

2. I have installed **drip irrigation** to the extent that the existing system was capable of handling. Some areas still require some hand watering, but it is not burdensome.

3. One unavoidable task is **keeping the layout clean**. I use the low power blower (see right) to move the debris to the lawn and walks where our gardener can dispose of them. (I won't allow him on the layout).

4. **Pruning** can be a time consuming task. I now do most of my trimming with an electric grass clipper. (see right) The results (getting a haircut) are somewhat like a lollipop tree shape, but accomplish the necessary trimming. I still use the narrow-nose clippers to trim low hanging limbs, clean the trunk and cut off new shoots that come up in the ground around the tree.

5. I do as little as possible with my **ponds and water-fall**. Periodically I remove as much of the debris as possible, but there is always a lot of organic matter to deal with.

6. For routine maintenance I usually **use the tools** you see in the picture. (A) Narrow-nose clippers easily cut around and inside your plant. (B) A rechargeable grass cutter, perfect for pruning small plants. (C) Soil moisture & Ph meter. (D) A rechargeable blower. Perfect for railroad use, it is much lower power than full sized leaf blowers and will usually not move your ballast or damage other things. A fully charged battery gives about 10 minutes of use only.

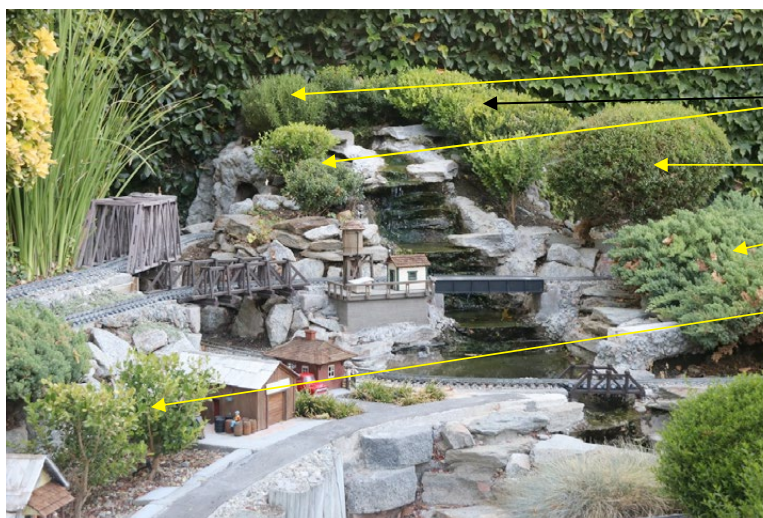

- Rosemary
- Boxwoods
- Dwarf Myrtle
- Juniper
- Boxwood

Photo by Carla Brand Breitner



- Ivy covered block wall
- Rosemary
- Boxwood
- Euonymus grove
- Dwarf Myrtle

Photo by Carla Brand Breitner



# The Home of Garden Railways

since 1987

**Good Times with Great Friends**  
25 UK Area Groups & Free Online Support



Join Today!

12 Months of Full Membership Now!

**4 Quality Journals (worth £20+)**  
Society Calendar, free Insurance\* & Technical Manual

[www.gscaleociety.com](http://www.gscaleociety.com)

\*see website for details

# The Valentine & Heartland RR Garden Guide continued



Photo by Carla Brand Breitner

- Ivy covered block wall.
- Euonymus
- Boxwood
- Ice plant
- Dwarf Pomegranate
- Boxwood
- Dymondia



Photo by Carla Brand Breitner

- Juniper
- Dwarf Pomegranate
- Hokkaido Elm
- Unknown name, miniature cypress?  
Very slow growing



Photo by Carla Brand Breitner

- Dwarf Myrtle
- Boxwood
- Miniature roses
- Boxwood
- Dymondia



Photo by Carla Brand Breitner

- Rosemary
- Boxwood
- Juniper
- Boxwood
- Dwarf Myrtle

*Examples of plantings  
growing throughout  
the Valentine &  
Heartland Railroad.*

# Battery Power Your TRAINS

For G, O, ON30, S, & HO Scale

**RailPro™**



**RailPro**  
Loco Modules  
w/sounds  
\$89 or \$167



Select 1 amp or 6 amp  
w/sound. Save \$139 over  
AirWire/Phoenix combo.



**RCS** REMOTE CONTROL SYSTEMS  
OF NEW ENGLAND

Sales • Installation • Service

**603-321-1347**

email: [donsweet@rcsofne.com](mailto:donsweet@rcsofne.com)

[www.rcsofne.com](http://www.rcsofne.com)



**Cedarleaf**  
Custom  
Decals

Call or Email  
Stan Cedarleaf  
928.778.3732  
[scedarleaf@aol.com](mailto:scedarleaf@aol.com)

Custom Decals  
Specifically Designed for  
Your Railroad  
[cedarleafcustomdecals.com](http://cedarleafcustomdecals.com)

G Scale Windows Doors &  
Much More!!

1:24 & 1:20

Window & door kits are laser cut  
from styrene and acrylic. Custom  
design available.

How-to  
All Weather Modeling In Stone &  
Cement

[www.RRStoneworks.com](http://www.RRStoneworks.com)

Toll Free: 1-877-473-4119 Email:  
[info@rrstoneworks.com](mailto:info@rrstoneworks.com)



**STONWORKS**

Support your Local Train Shops & Your Favorite On-Line Train Websites.  
Donate to Railroad Museums & Excursion Train Foundations. Keep Trains on the Rails in All Scales.



**REINDEER PASS**  
YOUR GARDEN RAILWAY HEADQUARTERS

Mike & Renee Kidman  
5220 NW 8<sup>th</sup> Street  
Ankeny, IA 50023

[ReindeerPass.com](http://ReindeerPass.com)  
[Renee@ReindeerPass.com](mailto:Renee@ReindeerPass.com)  
515-984-6946



Specializing in G scale products  
for outdoor garden railways.

**Precision Board: Pattern Sheet**

**Corrugated Metal: Galv. Steel**

**Custom, UV Stabilized Signs**

**Flickering Fire Electronics**

Website: [rainbowridgekits.com](http://rainbowridgekits.com)  
Ross & Sue Piper Lakeside, CA  
Email: [rainbowridgekits@aol.com](mailto:rainbowridgekits@aol.com)  
Phone & Fax: 619-561-0643

**TRAINZ**

Trainz wants your G scale collection!  
With over 45 years of experience,  
we make it easy to sell  
your collection.

[sellmytrains.com/grn](http://sellmytrains.com/grn)  
(866) 313-7919



Looking for a great selection  
of new and used trains?  
Visit [trainz.com](http://trainz.com)

## Double Float Roadbed

*Photos and article by Norm Baullinger*

Over the years, I have tried several methods for laying track on the ground primarily using a “hard/fixed” roadbed and a ballasted roadbed. I’ve had limited success with both of these approaches. Recently I had an issue on my layout that was on a corner, where it went through a small tunnel, and was close to a tree that caused the track to rise and tilt. Originally I had used a hard roadbed (Trex), and then several years later, when the roadbed moved, I removed the hard roadbed and just went with a ballasted roadbed. That only lasted a year. Due to derailments, I had to totally redo this section of the layout, moving the track away from the tree, tunnel and all.

**Background** - For the hard roadbed I dug a 3” – 4” deep trough, 6” – 7” wide, filled with ¼” minus gravel, wet (to help firm up the gravel) and tamped to a firm surface. I then drove composite (Trex) stakes in every 18” to 24”, leveled (smoothed and re-tamped) the roadbed, and then screwed Trex boards cut to the width of the track to the tops of the stakes. I then screwed track, through the ties, every several feet, allowing a small space between the six foot pieces of flexible track for expansion. Over time, the stakes would rise up or the gravel under the Trex would compact more and cause a depression. Also, contraction and expansion of the rail (I use code 250 aluminum rail) due to temperature, caused the track to want to move. But being constrained, as it was fastened down, it caused stress in the track. After time, the ties and slide joiners basically fixed themselves to the rail so the rail wouldn’t move in the ties. The result is that the roadbed/track would move or try to move and/or become discontinuous at the roadbed joints, and often pull rail out of the ties at the joints and/or where the ties were fastened down.

When just using ballast, I would also build a trench, fill with gravel, wet, tamp and level. Then I would lay the track on the gravel roadbed, add more wet ballast on top of the track moving it side to side to set it in. Just being ballasted, the track could “float” and move due to expansion and contraction, as it wasn’t fastened down to a fixed surface. This worked fine for a while but with time, the track would move, up, down, tilt, as the ballast would move, sink, disappear, or whatever. As a result I would have to remove/lift track, re-ballast, re-level, etc. This became a maintenance issue after a while as large sections of track would have to be re-worked even though it may have just been a local problem as on my corner and through the tunnel.

Note: I have not tried adding cement or similar to the ballasted roadbed.

**Solution** - Neither approach was satisfactory. After considering the causes and issues, I decided to relocate the track and try a “double float” roadbed/track. That is, float the roadbed and track separately. This is the new cut after removing the old tunnel, track and roadbed. *(top photo in right column)*



I used a hard roadbed, Trex again, but this time I didn’t attach the roadbed to stakes. After rebuilding the roadbed with ¼” minus gravel, wetting it, leveling, etc., I set pieces of Trex into the gravel roadbed every 12” or so. The top of the blocks were tamped in level with the top of the gravel roadbed. Note the tamper I used standing up. Where the Trex roadbed had a joint, I would use a slightly larger piece of Trex and screw each end firmly to the block.

After assembling the entire length of the roadbed and making sure all was smooth and level, I then screwed the hard roadbed to the rest of the blocks. This basically formed a continuous piece of hard roadbed that would float on the gravel roadbed.



*Continued on next page.*

*Continued from previous page.*

To fasten the track, I cut pieces of thin sheet metal strip, about 1" x 1", drilled a hole in the center and then screwed the strip of metal to the hard roadbed. The screw is put between the ties with the metal strip overlapping a tie on each side. I did not screw the metal strip down tight, just enough to keep the track down but still loose enough to allow the track to move if it wanted to. The track is basically floating on the hard roadbed.

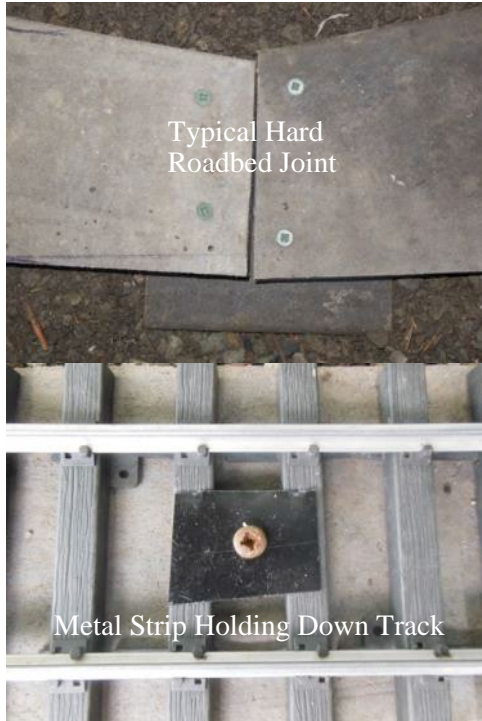

The advantage of this approach is the hard roadbed acts as a single continuous piece so it will float on the gravel roadbed and if the roadbed moves due to the forces of nature, it will be more continuous, eliminating sharp discontinuities that could pull rail out of the ties. The intermediate blocks help keep the roadbed smooth and level side to side. Rail expansion and contraction due to temperature swings, or roadbed movements are easily accommodated as the track will "float" on the hard roadbed and not cause stress that may pull rail out of the ties as it might if the ties were screwed down tight.



This approach is good in areas of your layout that may experience wide temperature swings due to changes in sun/shade during the day as well as summer to winter temperature differentials.



Track Prior to Roofing the Tunnel.

If the track needs to be removed for any reason, it is very easy to unscrew the metal strips and remove the track. If needed, additional ballast can be "pushed in" from the side under the hard roadbed to smooth out any depressions that may have occurred. Scraping out ballast from under the hard roadbed and/or a good sledgehammer will solve any problems where the hard roadbed may have risen due to nature. Or, if necessary, sections of the roadbed can be easily disassembled by removing the screws and re-leveling. Note: roots under the roadbed may cause it to rise over time and should be removed. The finished track/roadbed is shown above prior to adding the tunnel roof.



I refer to this approach as a "double float" roadbed, the roadbed floating on the ballast and the track floating on the roadbed. After laying the track, rebuilding the tunnel and adding landscaping, the finished project is shown above. You can see the metal strips holding the track down and that ballast has been added covering the Trex. I re-built three areas totaling about 35 feet of track this way. I have now done this to several areas of my layout over the past several years and have not had anywhere the maintenance issues I've had before.



Louise Sewall, Editor of the Long Island GRS *Smoke & Cinders*, used her column to write about the GR News Facebook page. Thank you, Louise!



I am still enjoying the photos and videos posted on the GRNews Facebook page.

This new one was posted by Gary Lee from Oregon. "The engineer and fireman pose in front of #4 on a newly completed 4-span viaduct near Windy Point Junction on the Baker & Grande Ronde Railroad."

How inspiring!

Louise Sewall





# AIRWIRE®

NEW!

- ▶ Sleek and comfortable OPS throttle
- ▶ Big, bright and rugged graphics display
- ▶ Single turn speed knob with speed readout
- ▶ Dedicated key for locomotive direction
- ▶ Long-life Li-Ion protected rechargeable battery
- ▶ Easy to use and very simple to setup
- ▶ Compatible with all AIRWIRE products

AIRWIRE is the preferred battery-powered wireless DCC control system for garden railroads. And the new T2300 OPS throttle has several new features requested by many customers. The new sunlight-readable graphics display shows the active locomotive number, frequency, speed and direction. The built-in backlight can be turned on or off with a single key press. Multi-unit locomotive consists are easily built, changed or deleted. Operation is simple - tap the power key, enter the loco number and drive away. Available now at any of our authorized AIRWIRE dealers or direct from CVP. For ordering options and pricing, please see the CVP website.

CVP PRODUCTS Richardson, TX [www.cvpusa.com](http://www.cvpusa.com)

## ANIMALS FOR THE GARDEN RAILROAD: TEXAS LONGHORNS

By Don Herzog



1.



2.



3.



4.

When I first started collecting items for my garden railroad 50 years ago, I made a list of vignettes or scenes that I wanted to portray. I had worked as a Greensman, landscaping several western movie sets and had become enthralled with the Texas Longhorn cattle drives. The animals, cowboys, and a chuck wagon would make a nice scene, but where do I get my props? The easiest source seemed to be Preiser ads in *Model Railroader* magazines, but the animals were expensive and the variety limited. So, I went to a few toy stores where I found multitudes of toy animals that seemed to be the right price, right size, well made, and in a multitude of poses.

After looking around, I was given a Schleich and Safari catalogue to check out further at home. The store owner said that he could get for me anything in the catalogue that I wanted. WOW! I also noticed a few usable animals made by Papo and by Bullyland. In the past few years, Mojo Fun Toys and CollectA, both having great animals, have arrived on the scene.

These animals are made for about 75 percent children and 25 percent collectors and are meant to fit small hands. Thus, the larger animals are fine for our garden railroads while the sheep, chickens, rabbits, and dogs are too large for our use.

I have only been collecting these for the past 30 or so years. In the beginning the cows, horses etc., were made at a scale of about 1:24. Now, kids are bigger, so the scale has changed to about 1:20. That is wonderful. Some cows, horses, etc., are tall and some are short just like people and this adds variety to our scenes. Also, like cars that change models each year, these companies add new figures and change the colors of older models. For me, I find everything that I now need manufactured by Schleich, Safari, CollectA, Mojo, and Papo. I do on occasion, however, find a nice animal of some unknown manufacturer at big box stores around Christmas.

About 35 to 45 Longhorns make a nice cattle drive for me. My scene consists of 43 Longhorn figures and I may add three more calves the next time I set it up. There are 19 Schleich, 10 Safari, 1 CollectA, 3 Mojo, 4 Bullyland, 3 Papo and 3 Maison brand animals that were purchased at Target in this vignette.

Schleich and Safari can be found in many toy and farm stores as well as big box stores. Mojo figures are available at amazon.com, walmart.com and at many Hobby Lobby stores. CollectA can be found at internet stores and on eBay and Papo can be found at some toy stores. Internet stores and eBay are great sources for

SEE ANIMALS ON PAGE 

**ANIMALS, CONTINUED FROM PAGE 31**



5.



6.



7.

both new and discontinued items. Schleich and Safari both have an internet store where you may also find some animals on special. Schleich, Safari, and Mojo have a free catalogue available at selected toy stores.

I live 65 northwest of San Francisco and set out my figures and wooden buildings starting about mid April when the rainy season usually ends and it gets pleasantly warm outside. They are washed and stored inside starting in early October. During the summer, it may get as hot as 115 degrees for a few days and I find that some of the animals get a bit soft on the outside. This lets them pick up some dirt if the wind blows. However, I don't mind having my cattle a bit dirty. They don't take a bath every day and get squeaky clean when out on the trail!

The pictures here and on the previous page are from my collection that have been out in the weather for the past four or five summers, so you can see how they look now. There are a few new ones available that I have not yet added to my herd. All other accessories in my scenes will be covered in future articles.

*Photos:*

1. Schleich bulls and calf
2. Safari bull
3. CollectA bull
4. Mojo bull
5. Papo bull and cow
6. Bullyland bull
7. Maison bull
8. Cattle Drive



8.



**MGRS MEMBER JIM HOGENSON**  
**WAS BUSY IN 2020...**

*How much fill does it take to elevate your railroad and how much time does it take to make perfection? Jim has some answers. Read on.....*



I've expanded my layout footprint by about two-thirds with roughly 110 tons of fill and a few tons of retaining wall block, so have lots of new space to work with. My goal is to gradually build up an old west mining town in the newly added area.

So to kick things off in that endeavor, I have built the first four buildings (from scratch) for the old west town, and here they are. I think only about half of my time was spent actually building the new structures. The other half of my time was spent making it all look like I built it 100 years ago. The buildings are built from cedar infused with enough clear acrylic weather proofing to make them act more like plastic when it comes to repelling water.

The wood started out as ordinary cedar boards from Menards. Then I used my band saw to cut the stock lumber down to tiny boards. Siding boards are about 1/16" thick by 1/2" wide by however long, usually 8" to 12" or however long I need. Structures were built first using Titebond III weatherproof glue.

Then comes the weather proofing....

First coat of weather proofing was actually stain and weatherproofing for a gray base. Then I added two more coats of clear, but not brushed or painted. I literally "dipped" the entire buildings and let them soak up however much acrylic they wanted, especially in cracks you couldn't get to with a brush. I dipped to whatever extent I could and "bathed" the buildings the rest of the way, literally

pouring cups of acrylic over the buildings, inside and out, over a big tub to catch and reuse the excess. I let the buildings completely dry for a couple days between coats. After about 3 coats, the weather proofed surfaces start to repel any more weather proofing.

The artistic touches are added after weather proofing, and window installation is last.

My oldest scratch built wood structures that were treated this way still look as good today as when I first built them. That's only about 5 years at this point, but I'm hopeful they will hold a while longer. A couple of scratch built buildings I purchased on eBay allegedly built for outdoor use completely self-destructed in 2 years.

The extra challenge with outdoor layouts is to make them look good but figure out how to make them stay looking good in a few years.

The weathering effects are all acrylic artists paint applied after weather proofing.



**Thanks Jim for the great article!**

*Santa Clarita, California, sun is hard on pines so one railroader used the acrylic dip method on his artificial replacements. – Ed.*





**STEAM IN THE GARDEN**

**We Are All About Real Steam on your Garden Railroad**

For over 30 years, *Steam in the Garden Magazine* has covered garden scale *live steam* trains. We provide information that is aimed at live steamers of all skill levels, bringing together the best that we can for the hobby. Available in **Print** and **Digital**. With a digital subscription you can download and take us with you on your laptop or tablet plus access our complete archive of magazines, over 30 years smallscale live steam of knowledge. Visit us online at [www.steamup.com](http://www.steamup.com) for more information. Until then – Happy Steaming!

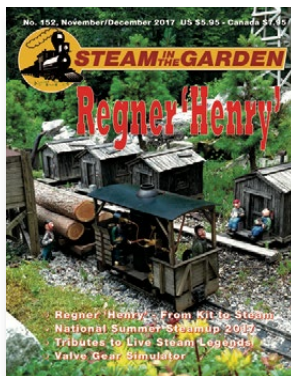



**EGGHAULERS**



WE HAVE GONDOLAS,  
FLAT CARS, BOX CARS,  
CABOOSES FOR YOUR EGGLINERS

**EGGHAULERS.COM**

**EAGLEWINGS IRON CRAFT**

"Buy your buildings just once!"  
Solid Steel Buildings



For many more buildings browse  
[www.eaglewingsironcraft.com](http://www.eaglewingsironcraft.com)



**38th National Garden Railway Convention 2023**

www.  
**GardenLines.net**

Nancy Norris  
creates gardens  
for model trains!



(925) 408-9402  
[nunorris@aol.com](mailto:nunorris@aol.com)  
Lic. #870086





**Train Installations**

Model railroads for home or business  
**Overhead-Garden-Tabletop**  
David Bennett  
770-597-0038  
[dave@traininstallations.com](mailto:dave@traininstallations.com)  
[www.traininstallations.com](http://www.traininstallations.com)

**OLD DOMINION RAILWAYS**

LGB Trains from Germany  
Sales - Repairs - DCC/DC Sound Decoder Installations

Website: [www.OldDominionRailways.com](http://www.OldDominionRailways.com)  
Email: [OldDominionRailways@gmail.com](mailto:OldDominionRailways@gmail.com)  
Thomas White - Cell: 703-946-4522  
Northern Virginia

Custom Built & Painted Large Scale Trains  
Custom Decals made to order



CATALOG \$7.00  
REFUNDABLE ON ORDERS OF \$50.00 OR MORE

**SHAWMUT CAR SHOPS.COM**  
307 North Michael Street, St Marys PA 15857  
818-834-9455  
email: [shawmutcarshops@yahoo.com](mailto:shawmutcarshops@yahoo.com)



### The Roadside Fruit Stand

by Mike Collyer, Petoskey MI

We've all seen them at some time, either on a long trip or an afternoon drive in the country. You can find them virtually anywhere selling almost everything any time of the year. Out in the country, depending on the location and geography, it could be apples, peaches, cherries, oranges, vegetables, flowers, honey, maple syrup, birdhouses, sewn goods, pies and baked goods, or Christmas wreaths; the list goes on and on. Even in the big city, you can find a smaller version of the same basic structure out on the sidewalk selling newspapers and magazines, or tickets to a sightseeing bus tour.

Attached to this newsletter there is an extra handout with some drawings for a "typical" roadside fruit stand in 1:29 scale. Since there is no "standard" design, these call out the major dimensions and some suggested materials but leave the specific construction details to the builder. Some stands are built to last only one season, others are built to last a life time. Frequently they are built out of whatever is on hand and only occasionally are new materials used. This particular stand has an 8'x8' footprint so as to not exceed a 4x8 sheet of plywood. The rear wall is roughly 6'-6" tall, and the front is 7'-6" tall. The shorter walls are all 36" high. The roof has a 12" overhang on all 4 sides. The 3/4" thick counter to the inside of the short walls is 16" wide. The side entrance is 32" wide.

The basic construction consists of:

- 4"x4" corner posts
- Walls are simple 2"x4" stud construction
- 1/2" plywood wall covering
- 1/2" roof sheathing
- 2"x4" roof rafters sitting on 2"x6" headers

The roof material could be any of:

- 3-tab shingles
- granular roll roofing
- tar paper
- metal roofing

Some stands have additional racks or shelves on the outside of the walls. Some are built open and left to the elements, while others have hinged awnings that can be shut and latched when closed to protect the interior. When it comes to colors and graphics, you can find literally anything. While many stands are a basic white with other color(s) for the trim and lettering, I have seen these in just about every color known. There was even one setup for the fall/Halloween season selling pumpkins, gourds, and straw bales that was painted black with orange lettering. In this same newsletter you will find an invitation to build one of these during the current shutdown. Here's a chance to exercise your imagination and create a stand of your own that can fit your particular layout.

Happy modeling  
Mike

*GR News Editor's Note: In response to a request to republish his article and drawings, Mike Collyer wrote, "Trying to keep our hobby alive during these tough times is more important now than it has been for a very long time. In that light, yes, feel free to share my Fruit Stand article in your publication." Mike's 1:29 scale drawings were originally laid out in a landscape format and have been rearranged for this publication.*



These roadside stand photos illustrate the possibilities.



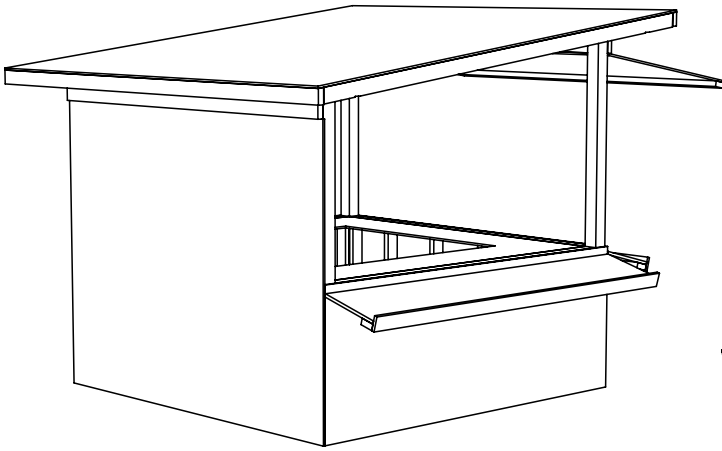

Structure with Optional Front Awning and exterior 16" Shelves

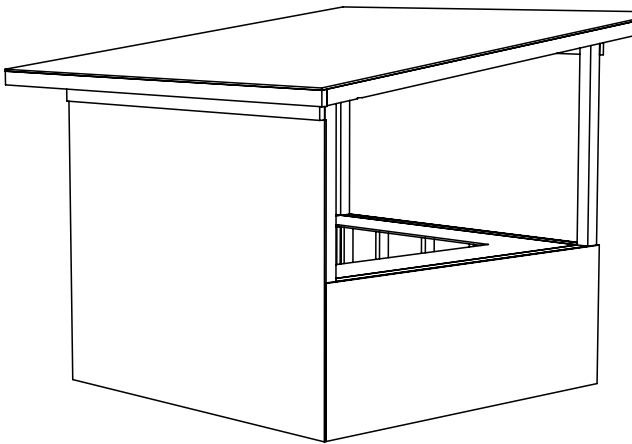
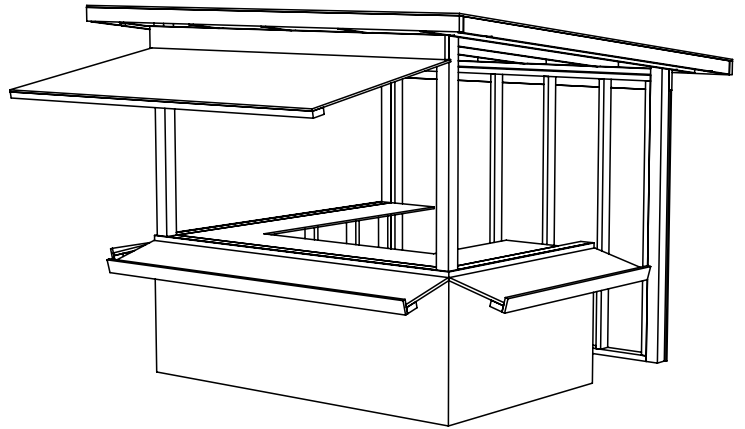

Basic Structure

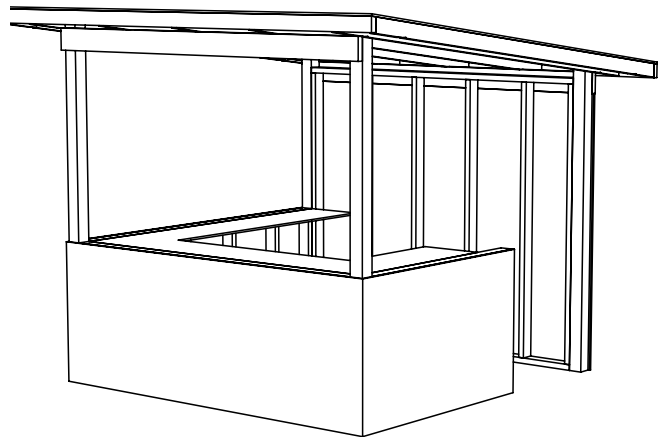

## Fruit Stand -Perspectives and Options

Scale: NA  
Drawn: Mike Collyer  
Date: Apr 10 2020



# Fruit Stand -Construction Details

Scale: 1:29  
Drawn: Mike Collyer  
Date: Apr 10 2020

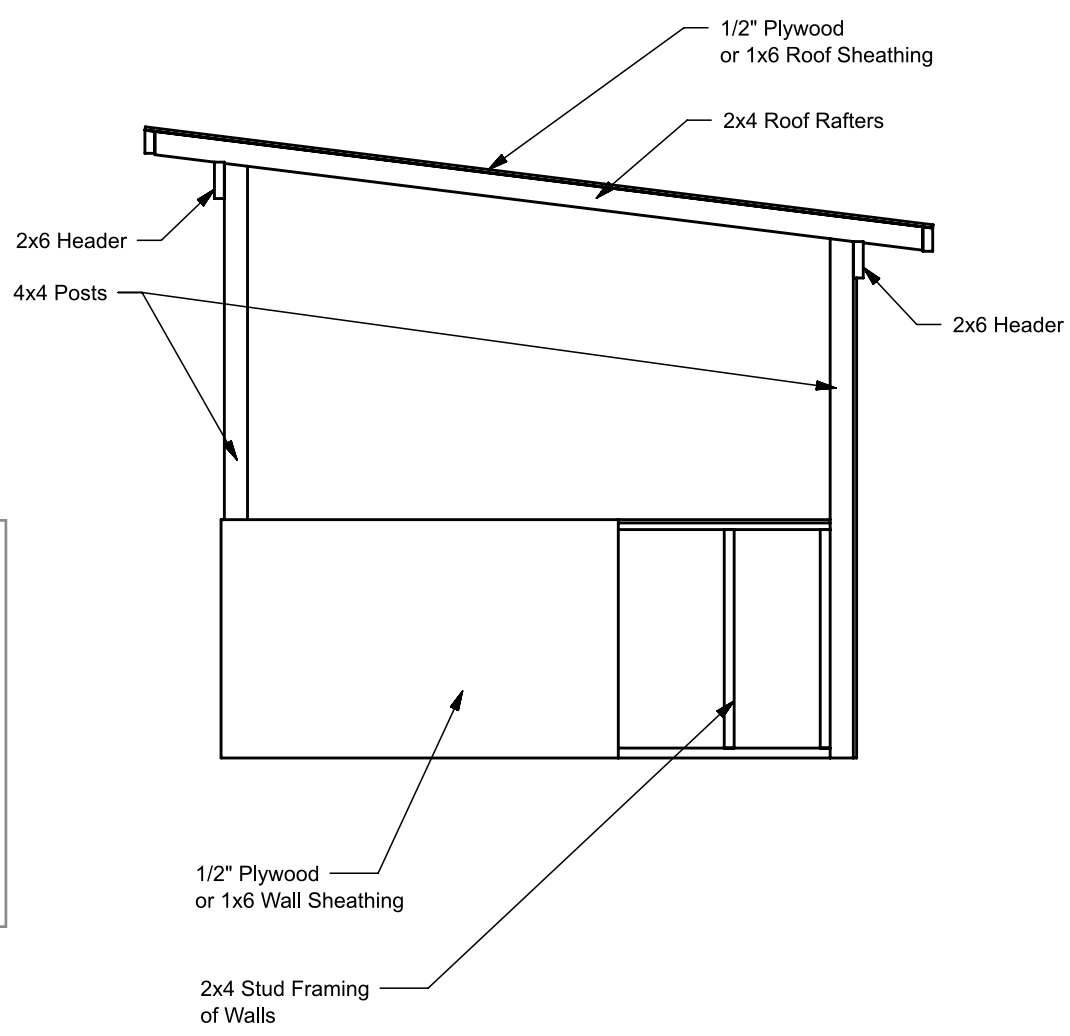
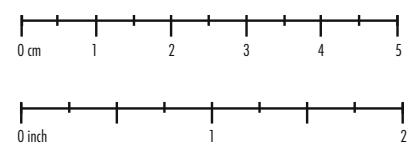
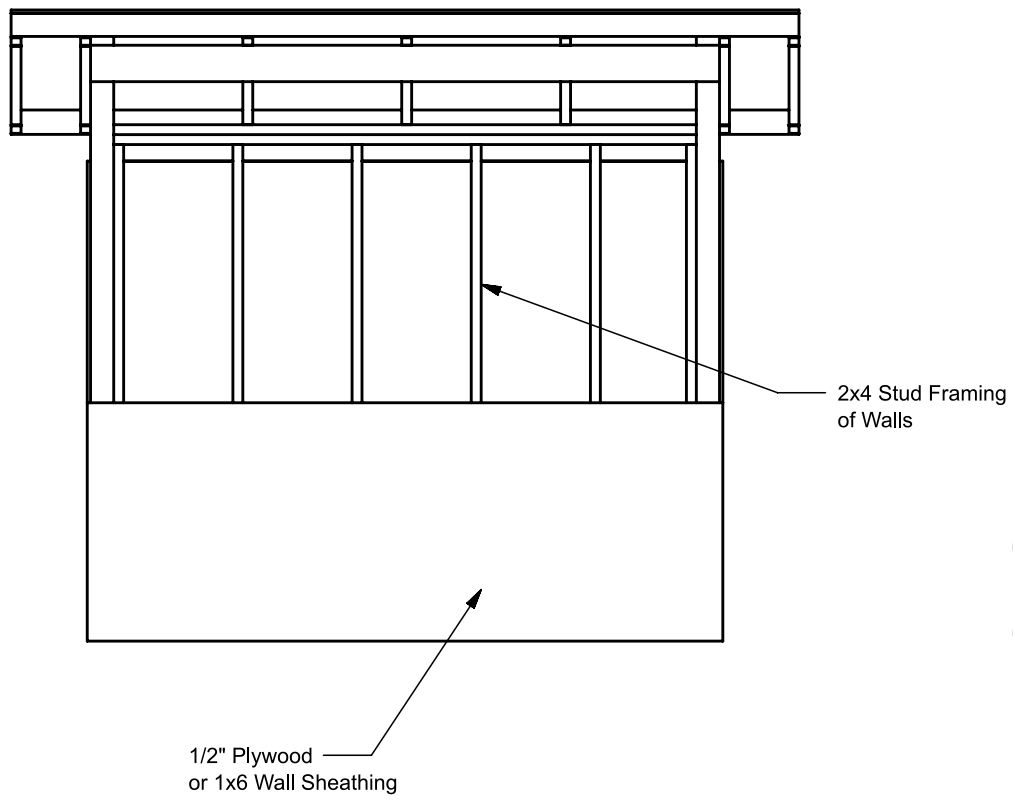

Select "Actual Size" to Print Drawing at 1:29 Scale

Input Custom Scale below For other G-Gauge Scales

For 1:32 reduce 90.6%

For 1:29 Actual Size 100%

For 1:24 enlarge 124%

For 1:22.5 enlarge 129%

For 1:20.3 enlarge 143%

For 1:19 (16mm) enlarge 153%

For 1:13.7% (7/8") enlarge 212%

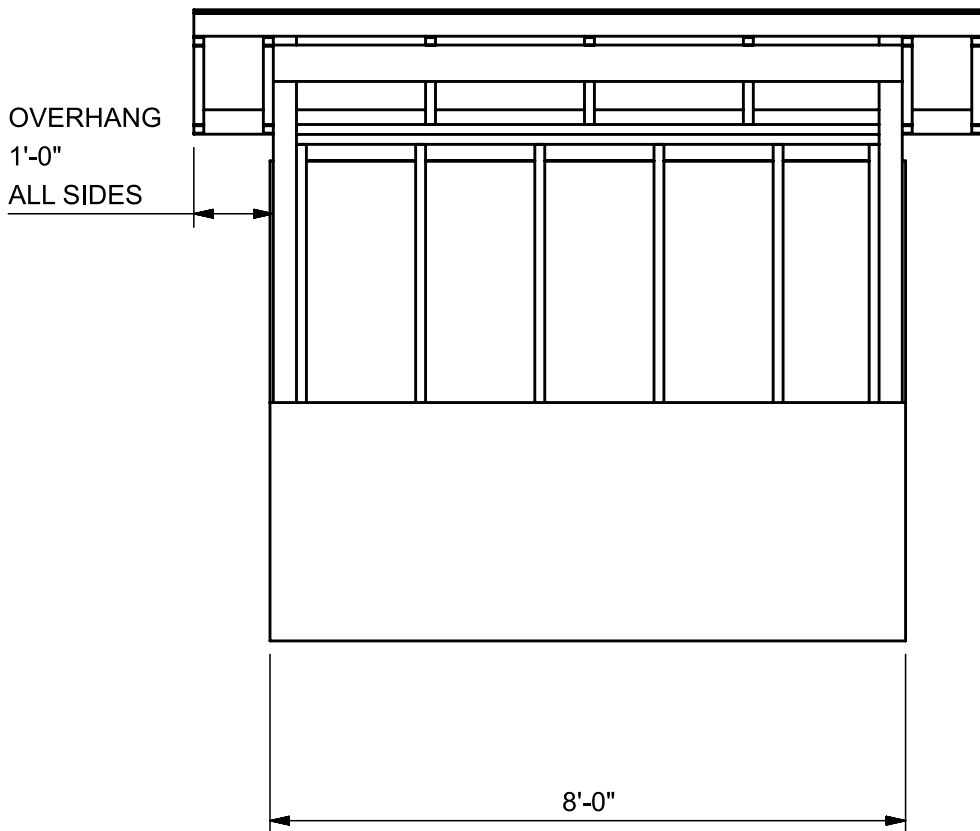

Select "Actual Size" to Print Drawing at 1:29 Scale

Input Custom Scale below For other G-Gauge Scales

For 1:32 reduce 90.6%  
 For 1:29 Actual Size 100%  
 For 1:24 enlarge 124%  
 For 1:22.5 enlarge 129%  
 For 1:20.3 enlarge 143%  
 For 1:19 (16mm) enlarge 153%  
 For 1:13.7% (1/8") enlarge 212%

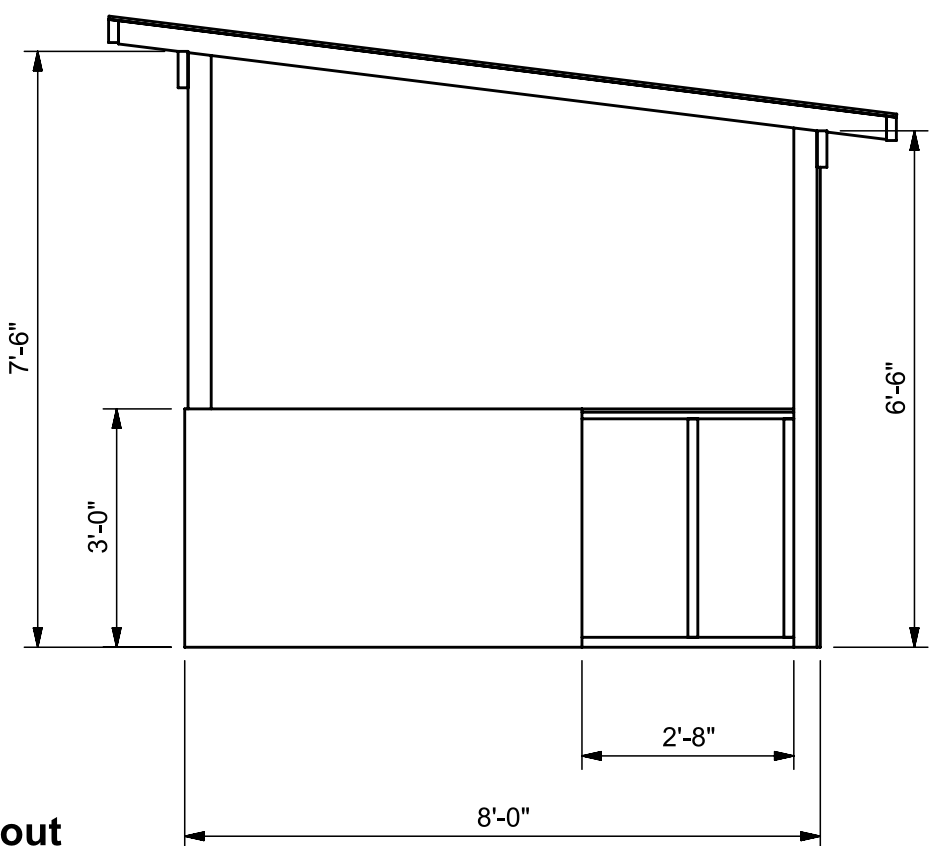
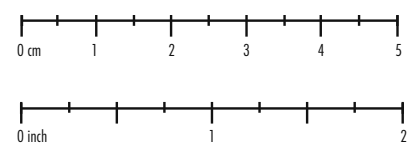

### Fruit Stand -General Layout

Scale: 1:29  
 Drawn: Mike Collyer  
 Date: Apr 10 2020



# DENVER GARDEN RAILWAY SOCIETY

proudly hosting the

**37th NGRC ★ JUNE 20-25, 2022**

**VISIT [NGRC2022.ORG](http://NGRC2022.ORG)**

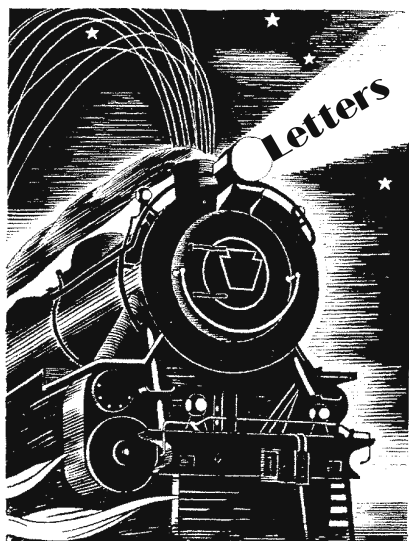

## STRAIGHT FROM THE IRON HORSE'S MOUTH

Letters to the Editor should be sent as e-mails only to Carla Brand Breitner at:  
[Editor@GRNews.org](mailto:Editor@GRNews.org)

Letters will then be addressed accordingly and/or passed on to the author for further edification. Unless marked otherwise, letters to this publication are assumed to be submitted for print. Please include your name and club affiliation. Please note that we may not be able to print all letters, though we will try to respond to them. Letters may be edited for length and clarity. We are unable to answer requests for information about specific products or systems; these are best addressed to the appropriate manufacturer.

### Michael's Birdhouse Kitbash

Great job! I enjoyed your article about modifying a Michael's birdhouse. It looks much like the cottage I designed in Tinkercad. I took my "doghouse" and stretched and added to it! I can't print it (yet) as it's too big for my printer to do in one piece, but it's ready. I added an external chimney, a porch, and a bathroom out back.

Richard L. Friedman  
 Sacramento Valley Garden Railroad Society

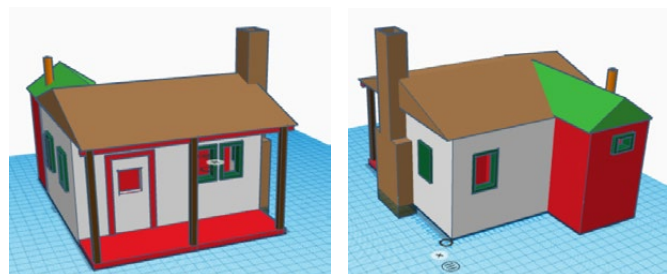

Dick Friedman's 3D Corner appears monthly in the Sacramento Valley GRS Valley Flyer. The November 2020 issue showed steps to creating a dog house file for 3D printing. Below are a few illustrations from the article which ended with this note:

"You can try this at home on TinkerCad.com. It is a free website, has tutorials and is quick to learn. When the design is finished, you can change the size of the dog house, either in TinkerCad, or after loading the file into your slicer (the program that converts this file into one your 3-D printer understands). There you can rescale the design."

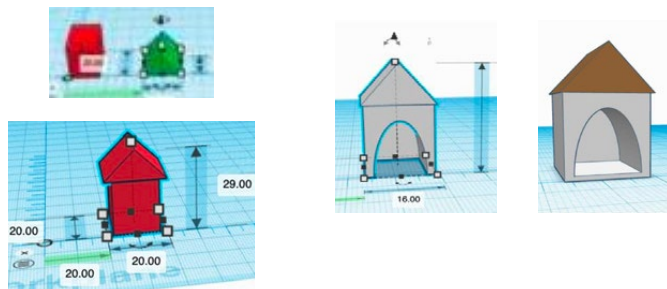

### Why we started Garden Railroading News

Dear Bill,

I am a German G-scaler, dedicated to US theme, and was a subscriber to *Garden Railways* for more than twenty-five years til the bad ending — and I sure suffer from its blow-up. A friend from Canada forwarded me your fine first e-mail-newsletter. It is truly great! Also I really do need the ad's division to get information on the market. BTW: my latest diesel loco came from Upland Trains. ;-)

Please register me for your wonderful *simplyGRNews* [now *Garden Railroading News* aka *GRNews* - ed.]. I appreciate its PDF-style as I am not a member with Facebook.

Thank you for your help! Best regards and stay in good health Have biG fun with biG trains !!°

Reinhold

Dr. med. Reinhold D. Braun

*Thanks for the welcome, Reinhold. Future issues will be downloadable at GRNews.org. Your message sums up our reasons for starting Garden Railroading News by explaining its impact. We are committed to sharing techniques and tips, while also connecting vendors with railroaders and modelers who enjoy working and playing in G-Scale.*





## Affiliated Clubs by State & Country as of 2/10/2021

- AR ..... Greater Hot Springs Garden Railway Society  
 ..... Northwest Arkansas Garden Railway Society
- AZ ..... Arizona Big Trains Operators  
 ..... Gadsden Pacific Div. Toy Train Operating Museum  
 ..... Oracle Community Learning Garden Kid's Railroad  
 ..... Tuscon Garden Railway Society
- CA ..... Bay Area Garden Railway Society  
 ..... Central California Coast Garden Railroad Society  
 ..... Del Oro Pacific Large Scale Modular Railroaders  
 ..... Diablo Pacific Short Line  
 ..... Fairplex Garden Railroad Volunteers  
 ..... Gandydancers  
 ..... Gold Coast Garden Railway Society  
 ..... Mendocino Coast Model RR & Navigation Co.  
 ..... Orange County Garden Railway Society  
 ..... Redwood Empire Garden Railway Society  
 ..... Sacramento Valley Garden Railway Society  
 ..... San Diego Garden Railway Society  
 ..... San Leandro Historical Railway Society G&O Rwy  
 ..... Santa Clarita Valley Garden Railroad Club  
 ..... Santa Fe & Butthead Cove RR Train Group  
 ..... Shasta Garden Railway Society  
 ..... Southern California Garden Railway Society  
 ..... Upland Garden Railroad Society
- CO ..... Denver Garden Railway Society  
 ..... Mile High Garden Railway Society  
 ..... Northern Colorado Garden Railroaders
- CT ..... Central Connecticut "G" Gaugers Modular Club  
 ..... Central Connecticut "G" Scalers
- DC/MD/VA ..... Washington, Maryland & Virginia GRS
- FL ..... Emerald Coast Garden Railway Club  
 ..... Florida Garden Railway Society  
 ..... Model RR Division of Florida RR Museum
- GA ..... Georgia Garden Railway Society
- IA ..... Central Iowa Garden Railway Society
- ID/WA ..... Inland Northwest Garden Railroad Society
- IL ..... Chicago Area Garden Railway Society  
 ..... LGB Model Railroad Club of Chicago  
 ..... Midwest RAILS (Railroaders Active In Large Scale)
- IN ..... Illiana Garden Railway Society
- MA ..... Rusty Rails & Rotten Ties
- MD ..... Mason Dixon Large Scale Railroad Society
- ME ..... Maine Garden Railway Society
- MI ..... Lakeshore Garden Railway Club
- MN ..... Minnesota Garden Railway Society
- MO ..... MO-KAN Garden Railroaders
- MO/AR/OK ..... Ozark Garden Railroad Society
- NC ..... Coastal Carolina Garden Railroad Society  
 ..... Gibsonville Garden Railroad Inc.  
 ..... North Carolina Garden Railway Society  
 ..... Piedmont Garden Railway Society
- NE ..... Rivercity Railroaders
- NH ..... New Hampshire Garden Railway Society
- NJ ..... South Jersey Garden Railway Society
- NM ..... New Mexico Garden Railroaders
- NY ..... Finger Lakes Live Steamers  
 ..... Long Island Garden Railway Society, Inc.  
 ..... Western New York Garden Railway Society
- OH ..... Buckeye State Garden Railroaders  
 ..... Columbus Garden Railway Society  
 ..... Greater Cincinnati Garden Railway Society  
 ..... Miami Valley Garden Railway Society  
 ..... Northern Ohio Garden Railway Society
- OR ..... Medford Garden Railroaders  
 ..... Northwest "G" Railroad Club  
 ..... Rose City Garden Railway Society
- PA ..... Lehigh Valley Garden Railroaders  
 ..... North Central Pennsylvania Mountains GRS  
 ..... Pennsylvania Garden Rail Society  
 ..... Southern Penn. Garden Railway Society (SEPGRS)  
 ..... Susquehanna Valley Garden Railway Society
- TN ..... Crossville Model Railroad Club  
 ..... Mid-South Garden Railway Society  
 ..... Nashville Garden Railway Society
- TX ..... Houston Area G Gaugers  
 ..... North Texas Garden Railroad Club  
 ..... San Antonio Garden Railway Engineer Society
- UT ..... Color Country Model Railroad Club  
 ..... Utah Garden Railway Society
- VA ..... Piedmont Railroaders  
 ..... Tidewater Big Train Operators
- WA ..... Puget Sound Garden Railway Society
- WI ..... Wisconsin Garden Railway Society
- NATIONAL US ..... Big Train Operator Club  
 ..... LGB of America

### CANADA

- Canada Black Mountain Railway Club  
 ..... BC Society of Model Engineers  
 ..... Burlington Model Railway  
 ..... Central Ontario GR Association  
 ..... Golden Horseshoe Live Steamers  
 ..... Greater Vancouver GRS  
 ..... London GRS  
 ..... Northern Alberta Garden Railroaders  
 ..... Ontario's West GRS  
 ..... Ottawa Valley GRS  
 ..... Rocky Mountain Garden Railroaders  
 ..... Vancouver Island GR Club

### COUNTRIES BEYOND NORTH AMERICA

- AUS ..... Garden Railway Club of Australia Inc.
- NZ ..... Auckland Garden Railway Group  
 ..... Christchurch Garden Railway Group  
 ..... Locos, Lads & Lasses  
 ..... Waikato Garden Railway Group  
 ..... Wairarapa Garden Railway Group  
 ..... Wellington Garden Railway Group
- CH ..... US G-Scale Friends Switzerland
- UK ..... G Scale Society United Kingdom

**Check our website: [www.GRNews.org](http://www.GRNews.org)  
 for an up-to-date Club Listing.**

## ADVERTISER INDEX

2021 NGRC Nashville .....	11, 21	G Scale Graphics .....	13	Starting in Steam .....	13
2022 NGRC Denver .....	39	G Scale Society – UK .....	25	Steam in the Garden .....	34
2023 NGRC Bay Area .....	34	J. S. Woodcrafts .....	13	Stoneworks.....	27
Airwire CVP Products.....	30	LGB America.....	10	Sunset Valley Railroad .....	17
Bridgemasters .....	17	Live Steam Station/Accucraft .....	6	Train Installations .....	34
Bridgewater .....	14	Mini Forest by Sky .....	17	Trainz.com .....	27
Cedarleaf Custom Railroad Decals .....	27	My Loco Sound .....	13	Valley Train Station .....	17
Eaglewings Iron Craft .....	17, 34	Old Dominion Railways .....	34	WifiTrax .....	20
Eckardt Design.....	12	RailBoss .....	13	Winona Garden Railway .....	15
Egghaulers.com .....	12, 34	Rainbow Ridge.....	27		
GardenLines.net .....	34	RCS of New England .....	27	<b>Real Estate Advertisers</b>	
Gary Raymond Wheels .....	17	Reindeer Pass .....	27	Nancy Norris • House with Railroads .....	12
		Shawmut Car Shops .....	34	Rick Blank • House with Railroads .....	5

# Garden Railroading News Update

from Bill Derville, Rose City Garden Railway Society President 2013-2019

**M**uch has happened since our Christmas edition. We are very grateful for the support of the 110 G-Scale clubs that have signed on to forward our magazine to their members. Of those clubs, 10 are from overseas. People who are not a member of a club can always download the magazine for free from our website GRNews.org as we have no current means of collecting e-mails for individual subscriptions. Look for our next issue in April.

Our content comes from club newsletters we receive each month. It is much easier and faster for us to copy and paste articles we believe you will find interesting and informative than to accept submissions from individuals. That's why the typeface and page style varies from article to article. We are not currently accepting articles submitted for publication other than from club newsletters as the editing and assembling of pictures and captions requires more than the limited hours we have to put this magazine together. We continue to look for useful one-page and two-page articles published in club newsletters. We only use material with permission of the author.

We are now charging for advertisements in our publication, but the rates are a fraction of what vendors were paying for advertising in a Kalmbach magazine. Our intent is to be able to fund a part time editor, as putting this publication together takes many hours. We can't expect that to go on without compensation for the hours spent on this project. We all owe Carla Breitner of the Santa Clarita Valley Garden Railway Society a huge thank you for our first three issues!

Earlier this month we formally organized as GRNews LLC. We have opened a bank account and set up a PayPal account to make payment from our vendors easier. Our next step is to launch our Advisory Committee which has members from Florida, Georgia, New York, Ohio, British Columbia, California and Oregon. This group will work on a written Operating Agreement, Vision and Mission Statements. The committee will advise on website enhancements and magazine content, solicit feedback from our clubs, and encourage clubs to forward our free newsletter to their members upon receipt. The first Advisory Committee meeting will be February 20th. If you have any suggestions for us, do send a note to our Marketing Director, Mick Spilsbury of the Bay Area Garden RR Society, at [marketing@GRNews.org](mailto:marketing@GRNews.org). He would love to hear from you!

We have a list of about 50 clubs that still have not signed on to our distribution program, so we are hoping to expand our network to more clubs. We currently have about 6,000 people viewing our magazine, assuming all the club members are receiving it. Our Facebook page has close to 1,000 members, many posting regularly.

Watch for more updates in future issues. We want to keep everyone in the loop and we appreciate any feedback you wish to send us. We all need to band together to grow this beloved hobby of ours.



Bill Derville  
GR News Network of Clubs  
Chairman of 2019 National Garden Railway Convention  
[simplyGRNews@gmail.com](mailto:simplyGRNews@gmail.com)

