



Tigers Tile Corp.

201 S. BISCAYNE BLVD. SUITE 2862 MIAMI, FL 33131, USA

DIRECT 305.767.2947 OFFICE 305.913.8998

sam@tigerstile.com

www.tigerstile.com

PUMA

COLLECTION

STONE

inspiration



AURIC

COLLECTION



120 × 280 [48" × 110"]

120 × 120 [48" × 48"]

60 × 120 [24" × 48"]

60 × 60 [24" × 24"]

AURIC | COLLECTION

/ LIGHT GREY

120 × 280 [48" × 110"]



6 mm
0.24"
2

60 × 120 [24" × 48"]



8 mm
0.31"
12

120 × 120 [48" × 48"]



8 mm
0.31"
6

60 × 60 [24" × 24"]



8 mm
0.31"
24



Tigers Tile Corp.

MATT



CE-AUGR-245

AURIC | COLLECTION



/ Auric LIGHT GREY

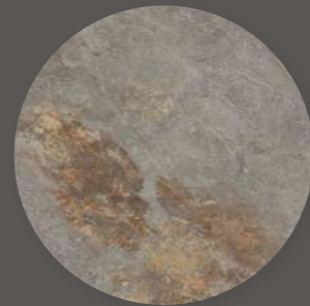

AURIC | COLLECTION

/ GREY



Tigers Tile Corp.

120 × 280 [48" × 110"]



6 mm
0.24"

2

60 × 120 [24" × 48"]



8 mm
0.31"

12

120 × 120 [48" × 48"]



8 mm
0.31"

6

60 × 60 [24" × 24"]



8 mm
0.31"

24

MATT



CE-AUGR-250

AURIC | COLLECTION



/ Auric GREY



TTC
Tigers Tile Corp.

AURIC | COLLECTION

/ GRAPHITE



Tigers Tile Corp.

120 × 280 [48" × 110"]



6 mm
0.24"

2

60 × 120 [24" × 48"]



8 mm
0.31"

12

120 × 120 [48" × 48"]



8 mm
0.31"

6

60 × 60 [24" × 24"]



8 mm
0.31"

24

MATT

PEI



CE-AUGR-255

AURIC | COLLECTION

TTC
Tigers Tile Corp.



GRAPHITE

DIGNITY

COLLECTION

TTC 
Tigers Tile Corp.

120 × 280 [48" × 110"]

120 × 120 [48" × 48"]

60 × 120 [24" × 48"]

60 × 60 [24" × 24"]

DIGNITY | COLLECTION

/ *BEIGE*

120 × 280 [48" × 110"]



6 mm
0.24"
2

60 × 120 [24" × 48"]



8 mm
0.31"
12

120 × 120 [48" × 48"]



8 mm
0.31"
6

60 × 60 [24" × 24"]



8 mm
0.31"
24



Tigers Tile Corp.

PEI ●●●●○ / MATT (R10)

CE-DIBE-230

DIGNITY | COLLECTION



/ Dignity BEIGE



DIGNITY | COLLECTION

/ LIGHT GREY

120 × 280 [48" × 110"]



6 mm
0.24"
2

60 × 120 [24" × 48"]



8 mm
0.31"
12

120 × 120 [48" × 48"]



8 mm
0.31"
6

60 × 60 [24" × 24"]



8 mm
0.31"
24



Tigers Tile Corp.

MATT

PEI ●●●●○ / R10

CE-DILG-225

DIGNITY | COLLECTION

/ GREY



Tigers Tile Corp.

120 × 280 [48" × 110"]



6 mm
0.24"
2

60 × 120 [24" × 48"]



8 mm
0.31"
12

120 × 120 [48" × 48"]





8 mm
0.31"
6

60 × 60 [24" × 24"]



8 mm
0.31"
24

MATT

PEI ●●●○○ /  / 

CE-GIGR-235

DIGNITY | COLLECTION



/Dignity LIGHT GREY



/Dignity GREY



DIGNITY | COLLECTION



GREY

DIGNITY | COLLECTION

/ GRAPHITE



Tigers Tile Corp.

120 × 280 [48" × 110"]



6 mm
0.24"
2

60 × 120 [24" × 48"]



8 mm
0.31"
12

120 × 120 [48" × 48"]



8 mm
0.31"
6

60 × 60 [24" × 24"]



8 mm
0.31"
24

MATT

PEI ●●●○○ /  / 

CE-GIGR-240

DIGNITY | COLLECTION

TTC 
Tigers Tile Corp.

LIGHT GREY & GRAPHITE

Tacoma

24"×24" 24"×48"
48"×48" 48"×110"

TTC 
Tigers Tile Corp.



matt surface

Tacoma

24"×24" | 24"×48" | 48"×48" | 48"×110"



SAND

DCOF 0.57 | R10 | PEI ●●●●

48" × 110" 120 × 280 cm



0.24"
4

24" × 48" 60 × 120 cm

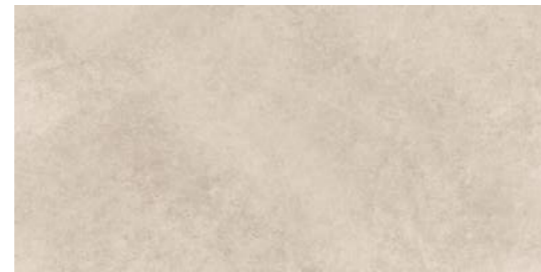

0.31"
9

24" × 24" 60 × 60 cm

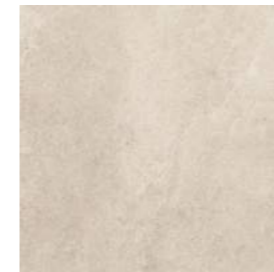

0.31"
18

mosaic

12" × 12" 30 × 30 cm



48" × 48" 120 × 120 cm



0.31"
8

step tread

12" × 48" 30 × 120 cm

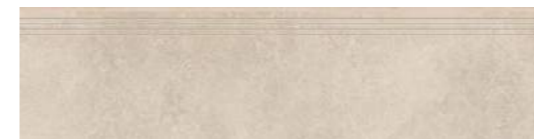

12" × 24" 30 × 60 cm

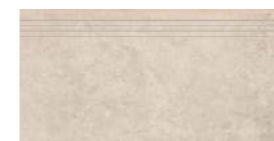

baseboard

3" × 48" 7 × 120 cm



baseboard

3" × 24" 7 × 60 cm



CE-TASA-200

COLLECTION

- ◀ sand
- white
- silver
- grey
- steel

VISUALIZATIONS

Tacoma

24"×24" | 24"×48" | 48"×48" | 48"×110"



WHITE

DCOF 0.57 | R10 | PEI ●●●●

48" × 110" 120 × 280 cm



0.24"
4

24" × 48" 60 × 120 cm



0.31"
9

24" × 24" 60 × 60 cm



0.31"
18

mosaic

12" × 12" 30 × 30 cm



48" × 48" 120 × 120 cm



0.31"
8

step tread

12" × 48" 30 × 120 cm

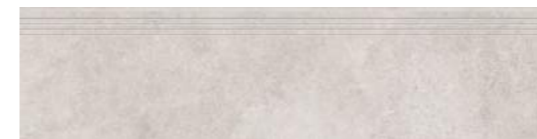

12" × 24" 30 × 60 cm



baseboard

3 × 48" 7 × 120 cm



baseboard

3" × 24" 7 × 60 cm



CE-TAWH-220

COLLECTION

sand

◀ **white**

silver

grey

steel

VISUALIZATIONS

Tacoma

24"×24" | 24"×48" | 48"×48" | 48"×110"



SILVER

DCOF 0.57 | R10 | PEI ●●●○

48" × 110" 120 × 280 cm



0.24"
4

24" × 48" 60 × 120 cm



0.31"
9

24" × 24" 60 × 60 cm



0.31"
18

mosaic

12" × 12" 30 × 30 cm



5903313304047

48" × 48" 120 × 120 cm



0.31"
8

step tread

12" × 48" 30 × 120 cm



12" × 24" 30 × 60 cm



baseboard

3" × 48" 7 × 120 cm



baseboard

3" × 24" 7 × 60 cm



CE-TASI-215

COLLECTION

sand
white
silver
grey
steel

VISUALIZATIONS

Tacoma

24"×24" | 24"×48" | 48"×48" | 48"×110"



GREY

DCOF 0.57 | R10 | PEI ●●●●

48" × 110" 120 × 280 cm



0.24"
4

24" × 48" 60 × 120 cm



0.31"
9

24" × 24" 60 × 60 cm



0.31"
18

mosaic

12" × 12" 30 × 30 cm

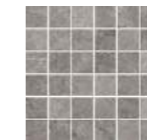

48" × 48" 120 × 120 cm



0.31"
8

step tread

12" × 48" 30 × 120 cm



12" × 24" 30 × 60 cm



baseboard

3" × 48" 7 × 120 cm



baseboard

3" × 24" 7 × 60 cm



CE-TAGR-210

COLLECTION

sand
white
silver
◀ **grey**
steel

VISUALIZATIONS

Tacoma

24"×24" | 24"×48" | 48"×48" | 48"×110"



STEEL

DCOF 0.57 | R10 | PEI ●●●○

48" × 110" 120 × 280 cm



0.24"
4

24" × 48" 60 × 120 cm



0.31"
9

24" × 24" 60 × 60 cm



0.31"
18

mosaic

12" × 12" 30 × 30 cm

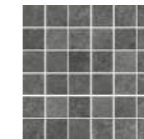

48" × 48" 120 × 120 cm



0.31"
8

step tread

12" × 48" 30 × 120 cm



5903313305334

12" × 24" 30 × 60 cm



5903313305280

baseboard

3" × 48" 7 × 120 cm



baseboard

3" × 24" 7 × 60 cm



CE-TASI-215

COLLECTION

sand
white
silver
grey

◀ **steel**

VISUALIZATIONS

Tacoma



PEI ●●●●●



sand

PEI ●●●●●



white

PEI ●●●●○



silver

PEI ●●●○○



grey



PEI ●●●○○



steel



COLLECTION

- sand
- white
- silver
- grey
- steel

VISUALIZATIONS

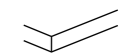

matt surface

color body



Tigers Tile Corp.

COLLECTION

sand
white
silver
grey
steel

◀ **VISUALIZATIONS**

Tacoma sand



Tigers Tile Corp.

COLLECTION

sand
white
silver
grey
steel

◀ **VISUALIZATIONS**

Tacoma white & grey



Tigers Tile Corp.

COLLECTION

sand
white
silver
grey
steel

◀ **VISUALIZATIONS**

Tacoma silver & grey



COLLECTION

- sand
- white
- silver
- grey
- steel

◀ **VISUALIZATIONS**

Tacoma steel

COLLECTION

BRAZILIAN QUARTZITE



Tigers Tile Corp.



IN THE RHYTHM OF EXCEPTIONAL DESIGN

**Vivacious, but full of class.
De nada!**



Do you hear that energetic music? Do you feel how the air vibrates, pulsates and resonates? Warm sand under your feet, a blue sheet of water on the horizon, and a singular thought in your mind: how to hold on to this aura for just a little bit longer, hold it in the palm of your hand and take it with you wherever you go, so this exotic feeling can delight you with its rhythm and contrast on a daily basis. You're already aware that parting with the azure ocean, golden beach and the deep, dark, rocky outcrops will be of great difficulty. But do you really have to part with it all?

BRAZILIAN QUARTZITE

/NATURAL

120 × 280
[48" × 110"]

✎4 / ✎0,6



120 × 120
[48" × 48"]

✎12 / ✎0,6



60 × 120
[24" × 48"]

✎24 / ✎0,8

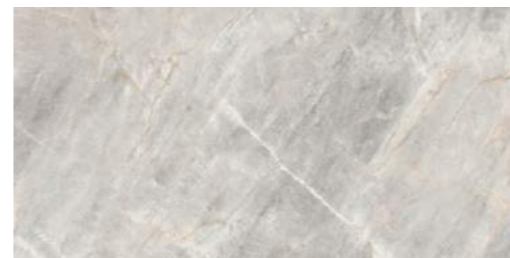

Tigers Tile Corp.

MATT | POLISHED
PEI ●●●●○ / (R9) | PEI ●●●●○

CE-BRQN-275

BRAZILIAN QUARTZITE

/ *GREEN*

120 × 280
[48" × 110"]

✂ 4 / ✂ 0,6



120 × 120
[48" × 48"]

✂ 12 / ✂ 0,6



60 × 120
[24" × 48"]

✂ 24 / ✂ 0,8



Tigers Tile Corp.

PEI ●●●● / (R9) | MATT | POLISHED
PEI ●●●●

CE-BRQN-270

BRAZILIAN QUARTZITE

/BLUE

120 × 280
[48" × 110"]

4 / 0,6



120 × 120
[48" × 48"]

12 / 0,6



60 × 120
[24" × 48"]

24 / 0,8



Tigers Tile Corp.

PEI ●●●●○ / (R9) | MATT | POLISHED
PEI ●●●●○

CE-BRQB-285

BRAZILIAN QUARTZITE

/ AMBER

120 × 280
[48" × 110"]

4 / 0,6



120 × 120
[48" × 48"]

12 / 0,6



60 × 120
[24" × 48"]

24 / 0,8



Tigers Tile Corp.

MATT | POLISHED
PEI ●●●●○ / (R9) | PEI ●●●●○

CE-BRQA-290

BRAZILIAN QUARTZITE

/BLACK

120 × 280
[48" × 110"]

4 / 0,6



120 × 120
[48" × 48"]

12 / 0,6





60 × 120
[24" × 48"]

24 / 0,8



PEI ●●●● / (R9) /  | MATT | POLISHED | PEI ●●●●

CE-BRQB-295

 - COLOR BODY /  4 - NUMBER OF GRAPHIC PATTERNS

BRAZILIAN QUARTZITE



/ Brazilian Quartzite BLUE



BRAZILIAN QUARTZITE



/Brazilian Quartzite GREEN

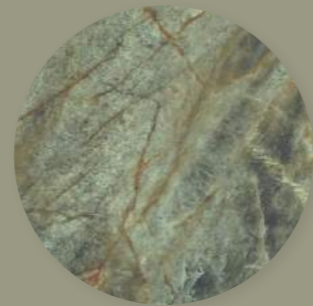

BRAZILIAN QUARTZITE

TTC
Tigers Tile Corp.

BLACK



BRAZILIAN QUARTZITE



/Brazilian Quartzite AMBER

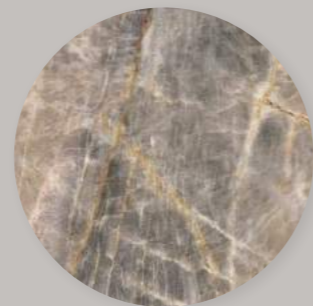

BRAZILIAN QUARTZITE

TTC
Tigers Tile Corp.

BLUE / NATURAL



DIMENSION AND PACKAGING



Tigers Tile Corp.

	Dimensions cm [in]	Pieces in the box	m ² [ft ²] in the box	Packaging weight kg [lb]	m ² [ft ²] / pcs on a pallet	Boxes on a pallet	Pallet weight kg [lb]	Frost resistance
RECTIFIED TILE	59,7x59,7x0,8 [24"x24"x0.31"]	4	1,43 [15.39]	27,30 [60.18]	45,76 [492.55]	32	873,6 [1925.95]	✓
	59,7x119,7x0,8 [24"x48"x0.31"]	2	1,43 [15.39]	27,31 [60.20]	47,19 [507.94]	33	901,2 [1986.6]	
	119,7x119,7x0,8 [48"x48"x0.31"]	1	1,43 [15.39]	27,31 [60.20]	42,90 [461.77]	30	819,3 [1806.0]	

PALLET

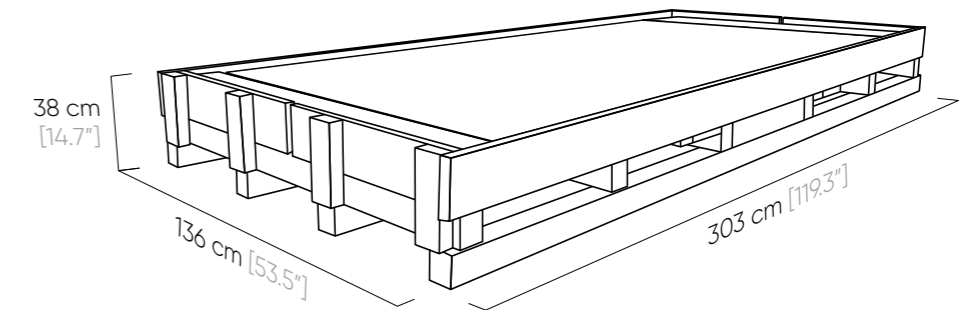

	Dimensions cm [in]	Pieces on a pallet	m ² [ft ²] on a pallet	Pallet weight kg [lb]	Pallet dimensions cm [in]	Frost resistance
A-FRAME	119,7x279,7x0,6 [48"x110"x0.24"]	38	127,30 [1370.24]	1980 [4365]	290x147,9x75 [114.2"x58.2"x29.5"]	✓
PALLET		25	83,75 [901.48]	1340 [2954]	303x136x38 [119.3"x53.5"x14.7"]	

A-FRAME

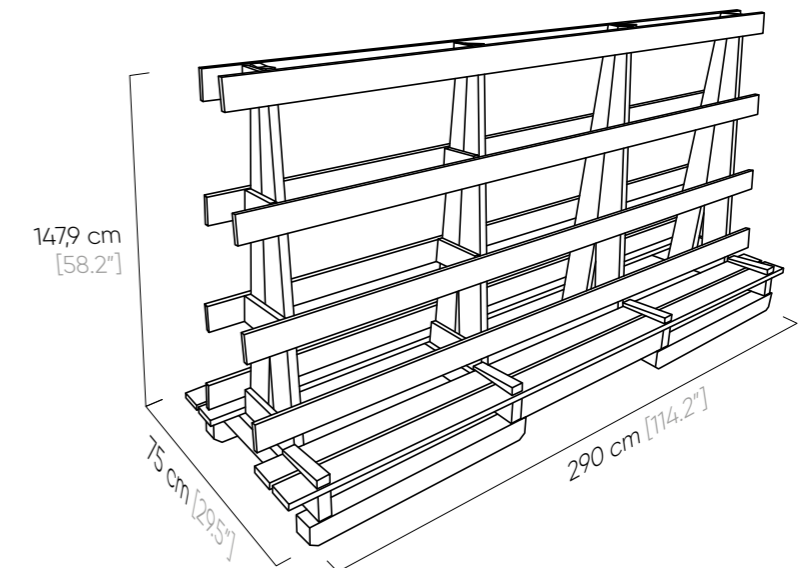



Tigers Tile Corp.

201 S. BISCAYNE BLVD. SUITE 2862 MIAMI, FL 33131, USA

DIRECT 305.767.2947 OFFICE 305.913.8998

sam@tigerstile.com

www.tigerstile.com