



avenli®

SHANGHAI JILONG PLASTIC PRODUCTS CO.,LTD

3F & 6F, Tower A1, No.2555 Xiupu Road, Kangqiao,
Pudong Area, Shanghai, 201315, P.R.China

Tel: +86-21-58942200

Fax: +86-21-58940305/58940434

E-mail: info@jilong.com

Web: www.jilong.com / www.avenli.com



© 2022 Shanghai Jilong Plastic Products Co., Ltd. ALL rights reserved. Printed in China.

SPA

Spas that free your mind

2023

CONFIDENTIAL

Over 30 Years Experience

JILONG is an export-oriented manufacturer of plastic leisure products with over 30 years of experience in R&D, high-quality manufacturing and worldwide sales. Sincerity, Practicality and Innovation has always been our business philosophy. All JILONG Manufacturing facilities are located within specially designated development zones which offer very favorable tax policies, utilities, new up to date infrastructure, and most importantly the major portion of our workforce originates in this zone, therefore lowering employee turnover, increasing a skilled retainable workforce. 100% of JILONG's capacity both manufacturing and component sourcing, is located within 300km of the Shanghai region. In house mass production for PVC sheets, flocking, lamination, printing, welding, filter pumps, metal frames and accessories provides production cost control.



- VERTICALLY INTEGRATED

JILONG completes a vertical chain from producing raw materials to end products. JILONG owns production lines of PVC film, silkscreen printing, high-frequency welding, sewing, and packing.

- WORLD WIDE VISION

JILONG products reach customers including global retailers in more than 50 countries in Europe, North America, Australia, and Asia, etc. With 6 subsidiaries worldwide, we are one of the major suppliers of plastic leisure products globally.

- CREATIVE IDEAS

JILONG's R&D team innovates hundreds of new products every year with superior design, Quality and environmentally-friendly compliance. Requirements of the global market and safety regulations are closely monitored. Various technical parameters of each new product have been tested and verified by the internal professional lab.



SHANGHAI-Head Office



JIANGSU-Facility (154,000m²)

PRODUCTS AND BRANDS



Safety & Quality



We maintain good cooperative relations with some well-known testing institutions, grasping/and grasp the latest changes in safety regulations to ensure that our products could comply with the laws and regulations of various countries where they are sold, so as to protect the life and property safety of consumers

- 94/62/EC On packaging and packaging waste
- 2011/65/EU Restriction of Hazardous Substances
- 2014/30/EU Electromagnetic Compatibility Directive
- EN 17125 Domestic spas/whirlpool spas/ hot tubs - Safety requirements and test methods
- 2014/35/EU Low Voltage Directive
- UL1563 Electric SPAs Equipment Assemblies, and Associated Equipment
- 2012/19/EU Waste Electrical and Electronic E
- C22.2 NO.218.1-13 SPAs Hot tubs, and Associated Equipment

Quality Assurance

The entire production process adopts a traceable management mode, and records and image acquisition are carried out in the incoming inspection of raw materials, the testing of key controlled substances, product durability experiments, online quality supervision, finished product inflation inspection, shipping and loading containers, etc., to ensure ensure the delivered products could meet the safety requirements and the products are authentic and reliable.

QUALITY ASSURANCE

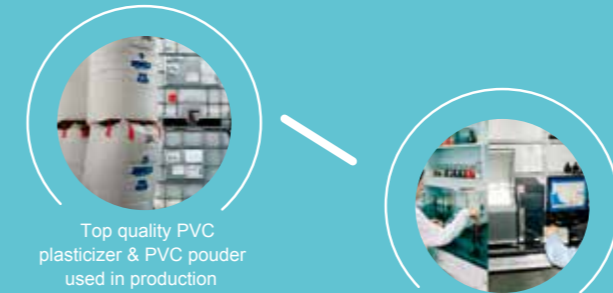

Top quality PVC plasticizer & PVC powder used in production



State-of-the-art internal lab and close cooperation with external lab to ensure quality of R&D



Durability Testing



Tightly controlled production process



24hr inflation test before packing & random inspection before shipment



Container Loading Records & Photos

The entire production process adopts a traceable management mode, and records and image acquisition are carried out in the incoming inspection of raw materials, the testing of key controlled substances, product durability experiments, online quality supervision, finished product inflation inspection, shipping and loading containers, etc., to ensure ensure the delivered products could meet the safety requirements and the products are authentic and reliable.

SALES And MARKETING

We have over 30 years of experience in inflatables industry to support our global partners.

We are constantly upgrading our packaging, sales promotion material, product manuals and other sales tools to service customers around the world, including big retail-chains, internet sellers, distributors, independent shops,etc.



Advertisement



Exhibition

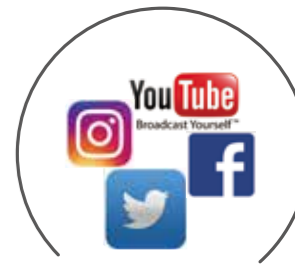

Social media

SUPPORT

Most of the products are equipped with instructions to guide consumers to use the product correctly.

Jilong has established an online information access platform. Consumers can quickly check and download e-manuals and review FAQs of related products by logging on to our website.

Step 1:

Login website:
www.zraysports.com
www.avenli.com
www.sunclubglobal.com

Step 2:

Select corresponding information according to product categories

Step 3:

If Manual & FAQ is not helpful, please send email to info@jilong.com

CONFIDENTIAL



AVENLI SPAS THAT FREE YOUR MIND!

Our reliable, high-performance spas are designed for comfort, efficient energy use, and simple maintenance so you can enjoy the full wellness benefits that come from making a hot tub part of your daily routine. Just a quick 20-30-minute dip counts as exercise...and so much more.

avenli®

COMFORT

The core of Avenli SPAs is Comfort. Dual massage tech helps you stay relaxed and seated even when enjoying powerful jets. Scientifically positioned massage melts your tension away. And related supporting accessories enhance the comfort experience.

INNOVATION

Our SPAs are carefully crafted with the details to awaken the senses. From rich patterns, various series to complete accessories, every element is intended to calm and delight.

PERFORMANCE

To make the most of your spa, it needs to operate at a consistently high level. Each SPA is engineered and built with the strictest attention to quality and efficiency. Our commitment is your assurance of reliable, energy-efficient performance for years.



Contents

1 All in one (AIO)

- Boston Spa (P10)
- Chicago Spa (P12)

2 CLASSIC

- London Spa (P20)
- Vienna Spa (P22)
- Madrid Spa (P24)
- Nice Spa (P26)

3 PREMIUM

- Milan Spa (P32)
- Victory Spa (P34)
- Oslo Spa (P36)
- Bergen Spa (P38)

4 EcoPlus™

- Saipan Spa (P44)

5 Avenli Accessories

- Cleanplus (P48)
- Energy saving (P55)
- Comfort&feel (P56)

CONFIDENTIAL

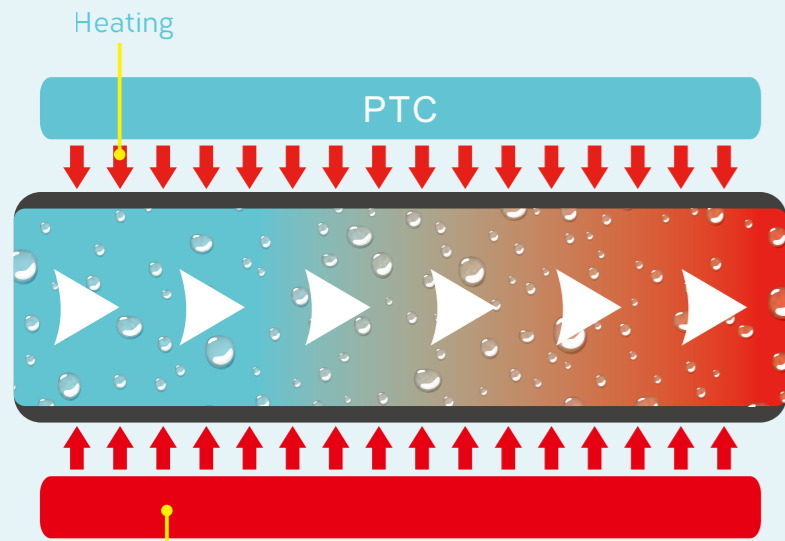

- | Thermal transmission | | |
|-------------------------------|---------------------------------|-------------|
| Fast | Stable | Safe |
| High power
Heat Up Rapidly | Constant Temperature
control | Waterproof |

Triple backflow-proof protection:

There are three mechanical valves designed to prevent water flow back into the working electric parts.

Three different parts of One way non-return valve

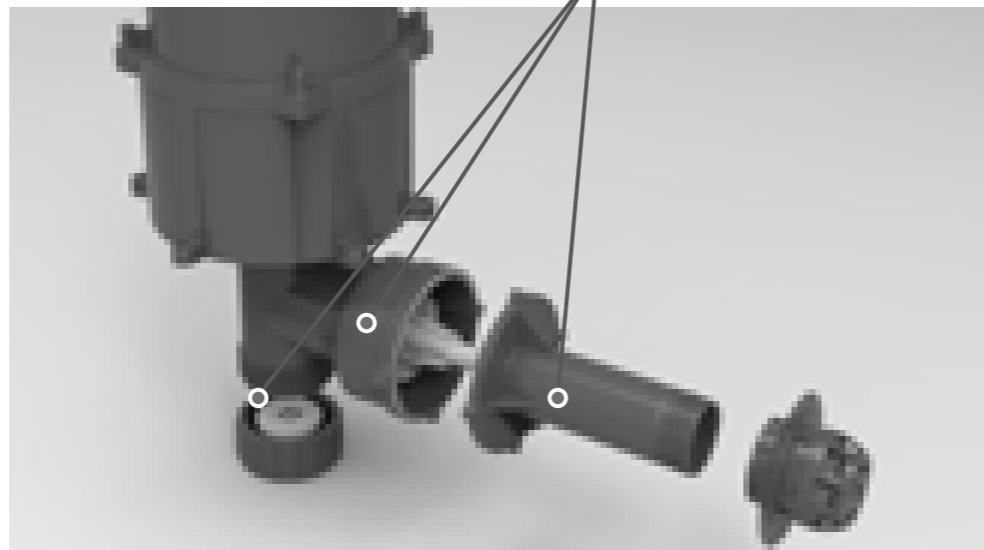

Dual Heating System (DHS)

To provide advanced enjoyment, our spa applies a unique dual heating system. The water is filtered and double-heated by the pump with PTC (Positive Temperature Coefficient) and Hydroelectric Separation Structure (HES), and then pumped into the SPA. It ensures rapid heating, stable temperature control, and adequate safety protection.



Effortless Water Treatment

Avenli is an effortless water treatment that combines purified water in addition to providing a unique massage experience via multiple jets. The combination of 3 high-strength filter materials, antibacterial options and energy-saving technologies offer a time saving maintenance solution.

All in one (AIO)

avenli®



Air Bubbles



Dual Heating System



Lockable Cover



Base Protector



Safety Lock



3-Speeds massages



Ozone



Anti-freeze



WiFi control



Timer

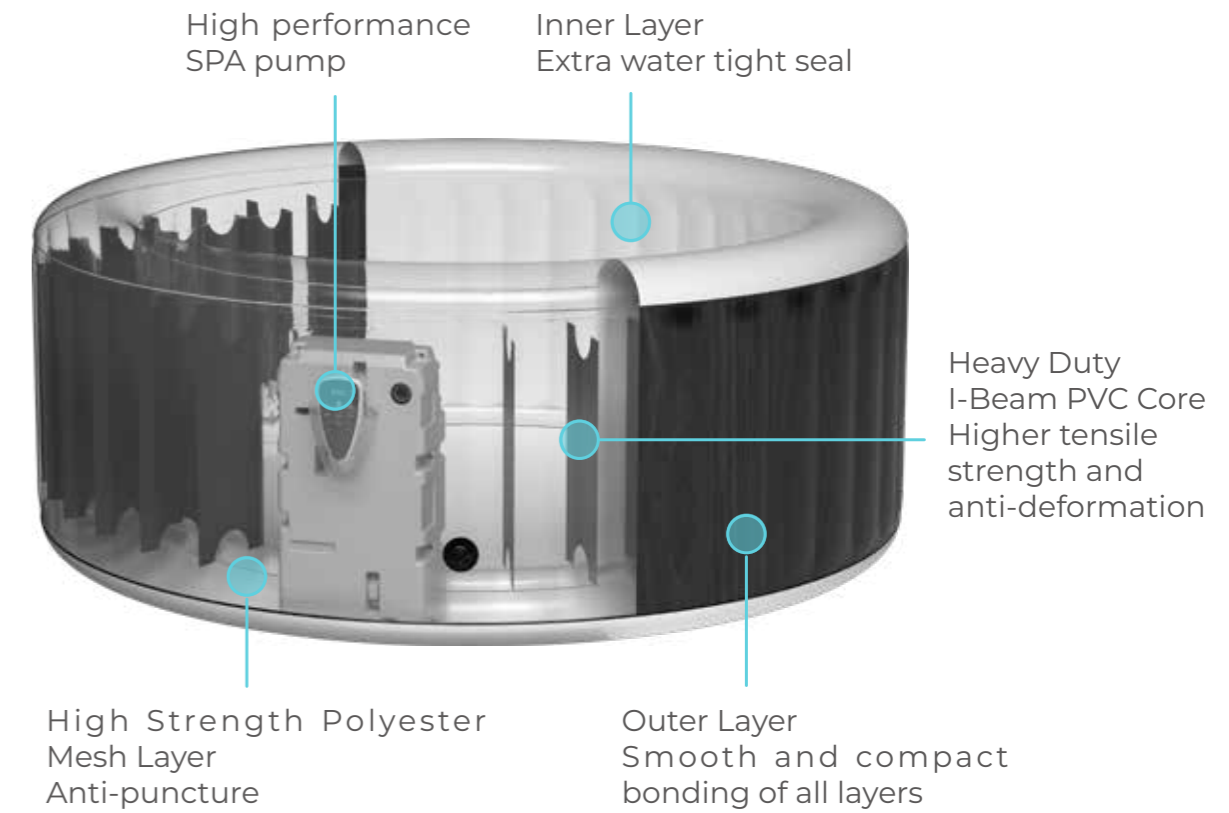
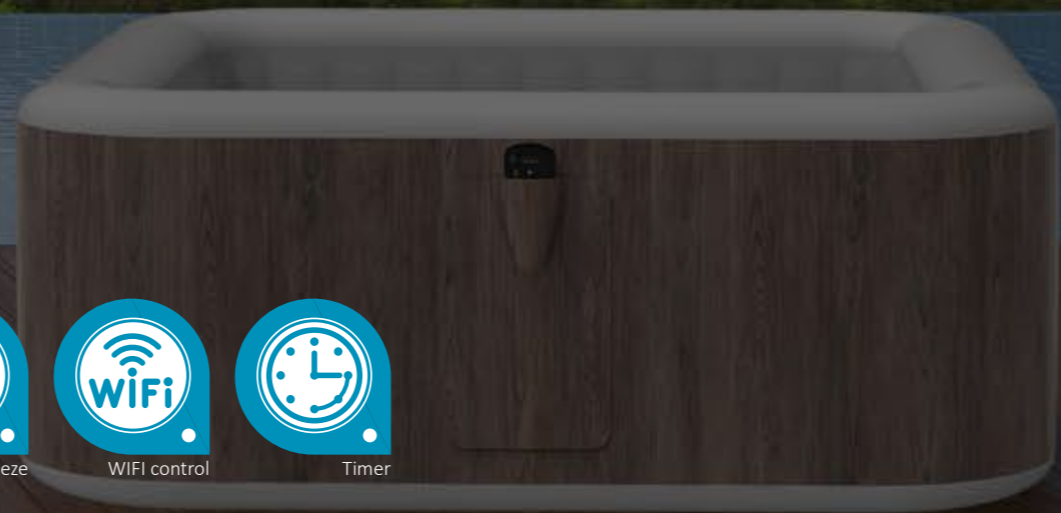

- Designed with the integrated heater unit built into the wall of the spa, this compact and streamlined inflatable hot tub can be controlled swiftly and easily via the accompanying controller.
- The integrated design reduces traditional pipeline connections, making the SPA look simpler and more elegant.
- The unique patented structure makes your installation easier.
- Double-insulated PTC heating structure, plus leakage protection plug, make your SPA safer.
- The whole series comes standard with the Anti-Freeze function, so that you can avoid the worry of SPA being damaged at low temperature.

• **OPTIONAL CONFIGURATION:**

- **WiFi, let you know your SPA situation at any time.**
- **Three-level massage, allowing you to have a variety of choices at different time periods.**
- **Ozone makes your SPA water more clear.**

CONFIDENTIAL



NEW

BOSTON

14015EU V43

- # Wooden pattern
- # Insulated top cover and floor protector included
- # Max temperature 42°C/108°F
- # Convenient waterproof remote control
- # # Heating timer
- # Freeze Protect
- # Grounding Test
- # Waterproof PCB



avenli®

CONFIDENTIAL

aveni®



NEW

CHICAGO

14016EU / 14014EU

- # Classical black color
- # Sturdy I-beam construction
- # Insulated top cover and floor protector included
- # Max temperature 42°C/108°F
- # Convenient waterproof remote control
- # Heating timer
- # Freeze Protect
- # Grounding Test
- # Waterproof PCB



CONFIDENTIAL

SPECIFICATION

Control System	EU:AC 220-240V 50HZ, 1545w	Certification	EU:CE
Heater	1545W	Filter Pump	530GAL (2006L)
Heating Rate	EU:1.5-2.5°C/hour	Bubble Jet Holes	108-138

Boston

Chicago

Chicago

14015EU V43

68cm x 38cm x 57.5cm

2-3

CE

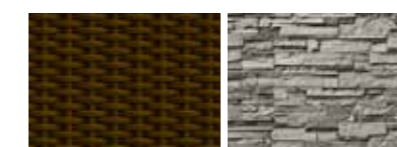

V31

V32

14016EU

68cm x 38cm x 57.5cm

2-4

CE

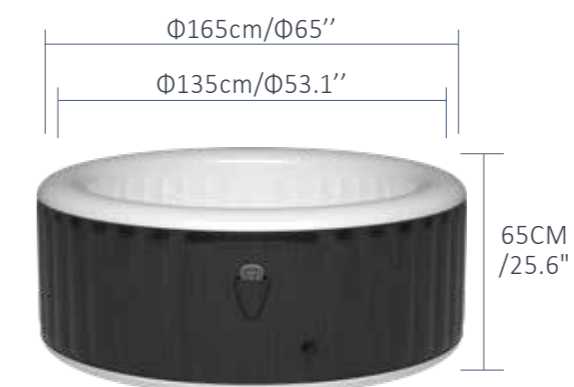

14014EU

68cm x 40cm x 57.5cm

4-6

CE

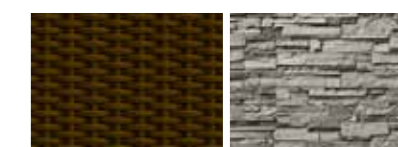
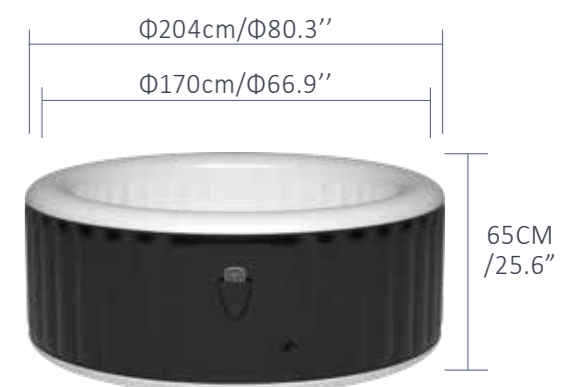

V31

V32

CONFIDENTIAL

CLASSIC

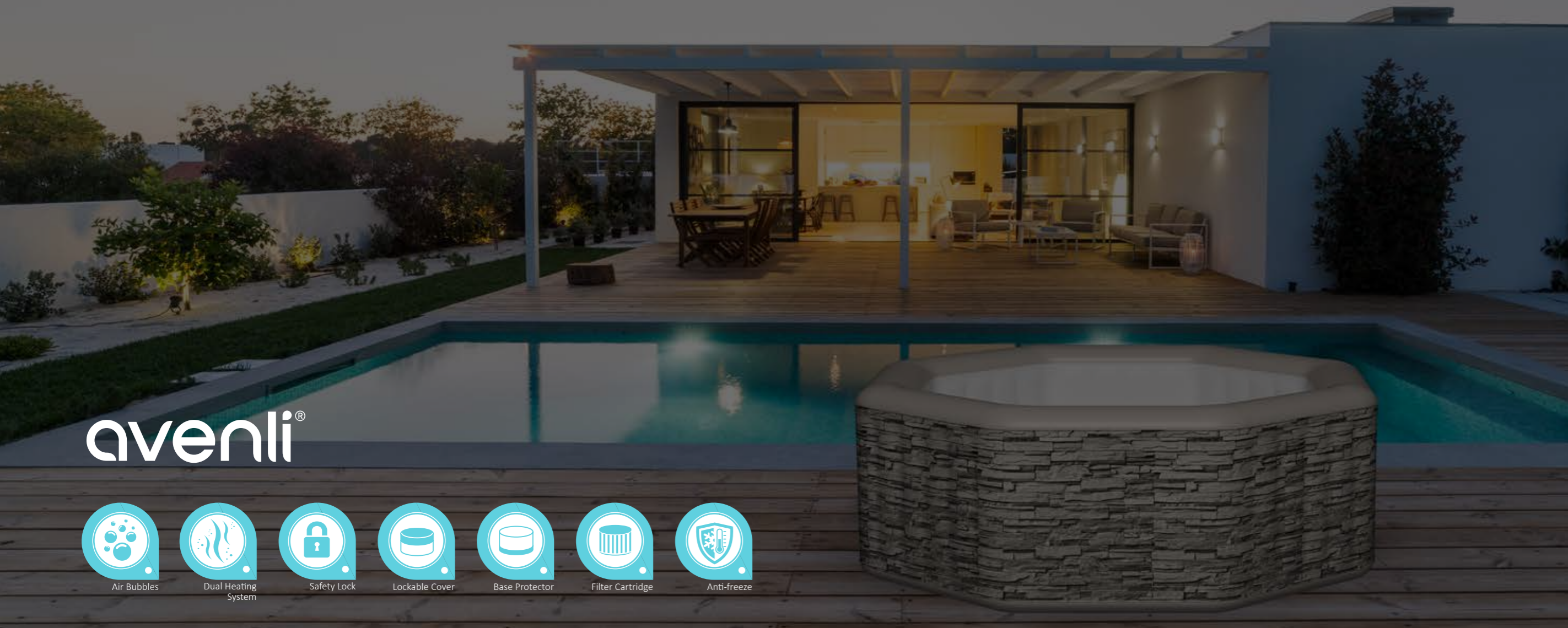

avenli®



Air Bubbles



Dual Heating System



Safety Lock



Lockable Cover



Base Protector



Filter Cartridge



Anti-freeze

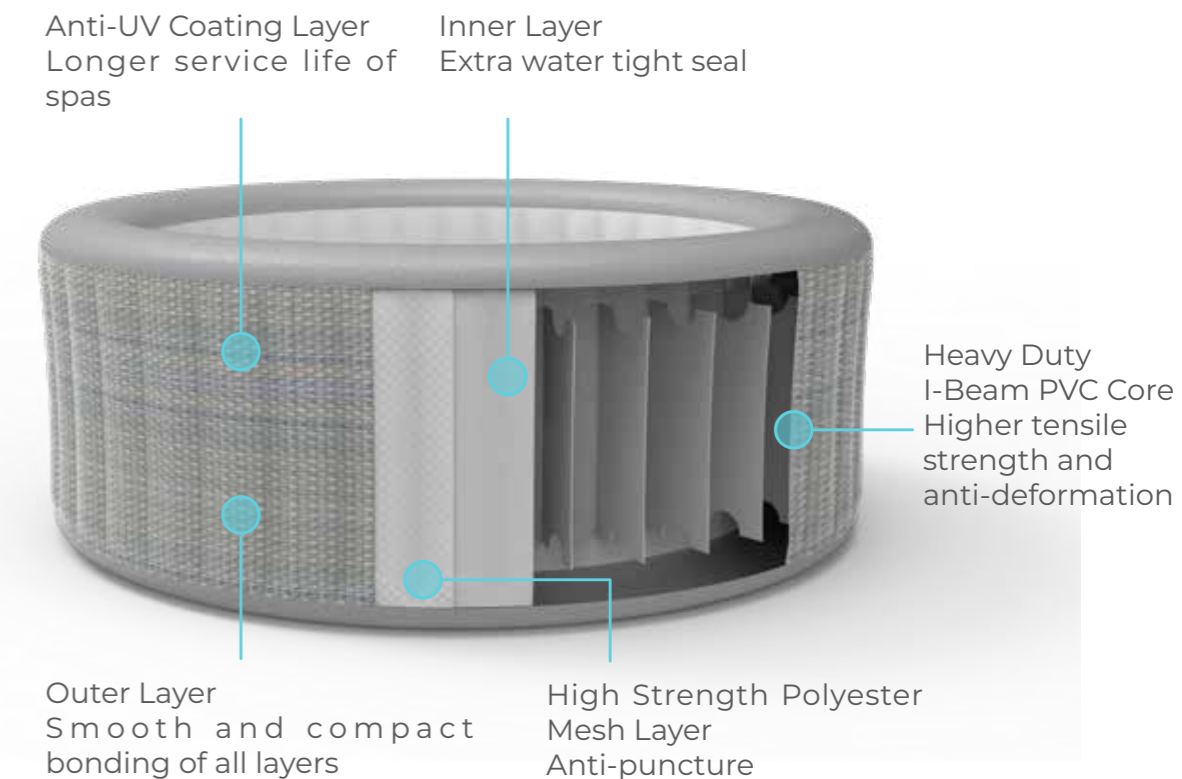

- **Classic appearance design, easy installation.**
- **The unique patented inflatable structure makes your installation easier.**
- **The special backwater design conforms the US IMPAO PS33 certification.**
- **Double-insulated PTC heating structure with leakage protection plug. All series conforms GS certification, making your SPA safer.**

CONFIDENTIAL



LONDON

17612EU / US

- # Special diamond beam construction make the SPA more durable
- # classical black color
- # Insulated top cover and floor protector included
- # Max temperature 42°C/108°F
- # Freeze Protect
- # Grounding Test
- # Waterproof PCB



avenli®

avenli®



NEW

VIENNA

17283EU / US V13

- # Sturdy I-beam construction
- # blackish green color with contracted style pattern
- # Insulated top cover and floor protector included
- # Max temperature 42°C/108°F
- # Freeze Protect
- # Grounding Test
- # Waterproof PCB



CONFIDENTIAL

NEW

MADRID

17654EU / US V32

- # Sturdy I-beam construction
- # Simple brick pattern with grey color
- # Insulated top cover and floor protector included
- # Max temperature 42°C/108°F
- # Freeze Protect
- # Grounding Test
- # Waterproof PCB



avenli®

aveni®



NICE

17286EU / US V31

- # Sturdy I-beam construction
- # Simple rattan pattern with grey color
- # Insulated top cover and floor protector included
- # Max temperature 42°C/108°F
- # Freeze Protect
- # Grounding Test
- # Waterproof PCB

CONFIDENTIAL

SPECIFICATION



Control System	EU:AC 220-240V 50HZ, 1540w US:AC 110-120V 60HZ, 1380w	Certification	EU:CE; US:cETLus
Heater	1540w;1380W	Filter Pump	530GAL (2006L)
Heating Rate	EU:1.5-2.5°C/hour; US:1-2°C/hour	Bubble Jet Holes	105-140

London	Vienna	Madrid	Nice
--------	--------	--------	------

17612EU/US
61.5cm x 45cm x 57.5cm
4-6

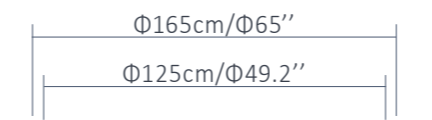

17283EU/US V13
63cm x 56.5cm x 57.5cm
4-6

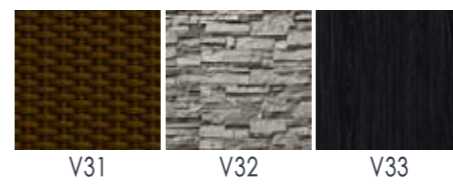
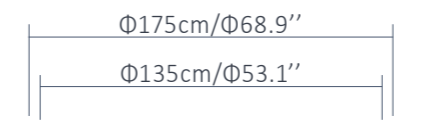

17654EU/US V32
63cm x 56.5cm x 57.5cm
4-6

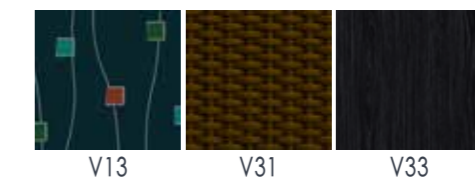
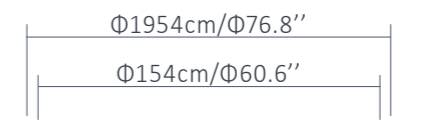

17286EU/US V41
68.5 x 63 x 57.5cm
4-6

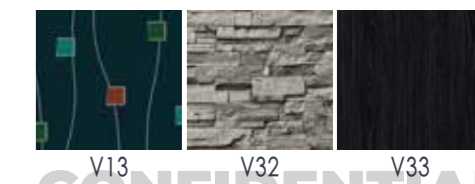

CONFIDENTIAL

PREMIUM

avenli®



Air Bubbles



Dual Heating System



Safety Lock



Lockable Cover



Base Protector



Filter Cartridge



3-Speeds massages



Anti-freeze



WiFi control



Timer

Anti-UV Coating Layer
Longer service life of spas

Inner Layer
Extra water tight seal

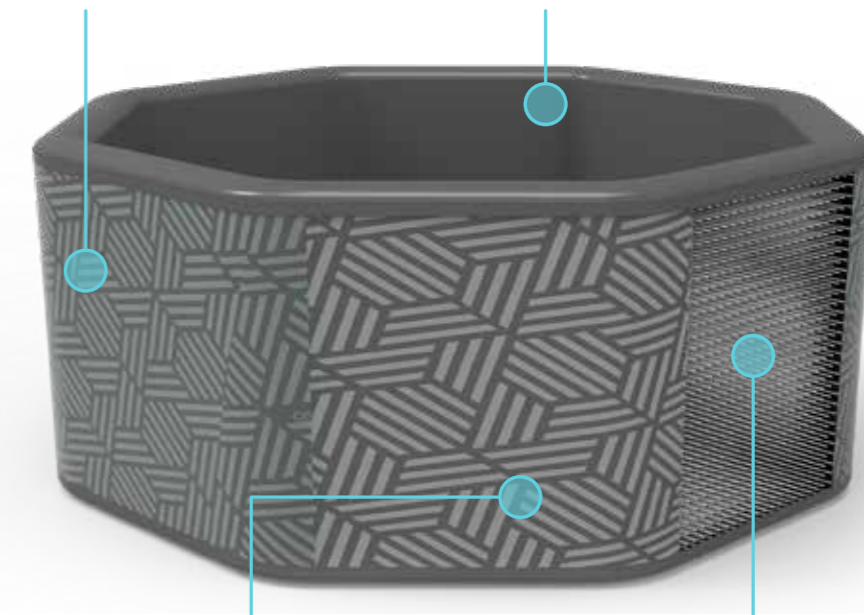

Outer Layer
Smooth and compact bonding of all layers

Drop Stitch Core
Higher compressive and tensile strength

- Drop stitch material structure is strong and durable, suitable for use in various weather conditions.
- Extra thickness of drop stitch increases 30% thermal insulation performance of the product compared with the same type of SPA.
- The unique patented structure and design of the SPA pump allow you to install your SPA in only 3 minutes, avoiding manual pumping.

OPTIONAL CONFIGURATION:

- **WiFi, let you know your SPA situation at any time.**
- **Three-level massage, allowing you to have a variety of choices at different time periods.**

CONFIDENTIAL

avenli®

MILAN

17660EU / US V01

- # Premium Drop Stitch Technology
- # Minimalist line pattern
- # Unique exterior uses ultra-rigid 5cm thickness Drop Stitch material for long-lasting strength and durability
- # Insulated top cover and floor protector included
- # Max temperature 42°C/108°F
- # Anti-bacterial filters keeps spa water cleaner by inhibiting bacterial growth
- # Freeze Protect
- # Grounding Test
- # Waterproof PCB



CONFIDENTIAL

PREMIUM - PAGE / 33



avenli®

VICTORY

17665EU / US V01

- # Premium Drop Stitch Technology
- # Minimalist line pattern
- # Unique exterior uses ultra-rigid 10cm thickness Drop Stitch material for long-lasting strength and durability
- # Insulated top cover and floor protector included
- # Max temperature 42°C/108°F
- # Anti-bacterial filters keeps spa water cleaner by inhibiting bacterial growth
- # Freeze Protect
- # Grounding Test
- # Waterproof PCB

CONFIDENTIAL

PREMIUM - PAGE / 35

avenli®

NEW

OSLO

14030EU / US V33W

- # Premium Drop Stitch Technology
- # Black marble pattern pattern
- # Unique exterior uses ultra-rigid 15cm thickness Drop Stitch material for long-lasting strength and durability
- # Insulated top cover and floor protector included
- # Max temperature 42°C/108°F
- # Anti-bacterial filters keeps spa water cleaner by inhibiting bacterial growth
- # Freeze Protect
- # Grounding Test
- # Waterproof PCB



CONFIDENTIAL



avenli®

NEW

BERGEN

14028EU / US V43W

- # Premium Drop Stitch Technology
- # Grey marble pattern pattern
- # Unique exterior uses ultra-rigid 20cm thickness Drop Stitch material for long-lasting strength and durability
- # Insulated top cover and floor protector included
- # Anti-bacterial filters keeps spa water cleaner by inhibiting bacterial growth
- # Max temperature 42°C/108°F
- # Freeze Protect
- # Grounding Test
- # Waterproof PCB
- # Wifi controller and 3 massages can be option

CONFIDENTIAL

SPECIFICATION



Control System	EU:AC 220-240V 50HZ, 1540w/2040w US:AC 110-120V 60HZ, 1380w	Certification	EU:CE; US:cETLus
Heater	1540w/2040W; 1380W	Filter Pump	530GAL (2006L)
Heating Rate	EU:1.5-2.5°C/hour; US:1-2°C/hour	Bubble Jet Holes	70-100

Milan	Victory	Oslo	Bergen
-------	---------	------	--------

17660EU/US V01 60 x 54.5 x 64cm 2-4 CE	17665EU/US V01 70 x 45.5 x 64cm 3-5 CE	14030EU/US V 33W 68.5 x 63 x 57.5cm 4-6 CE	14028EU/US V 43W 70cm x 60cm x 57.5cm 4-6 CE
--	--	--	--

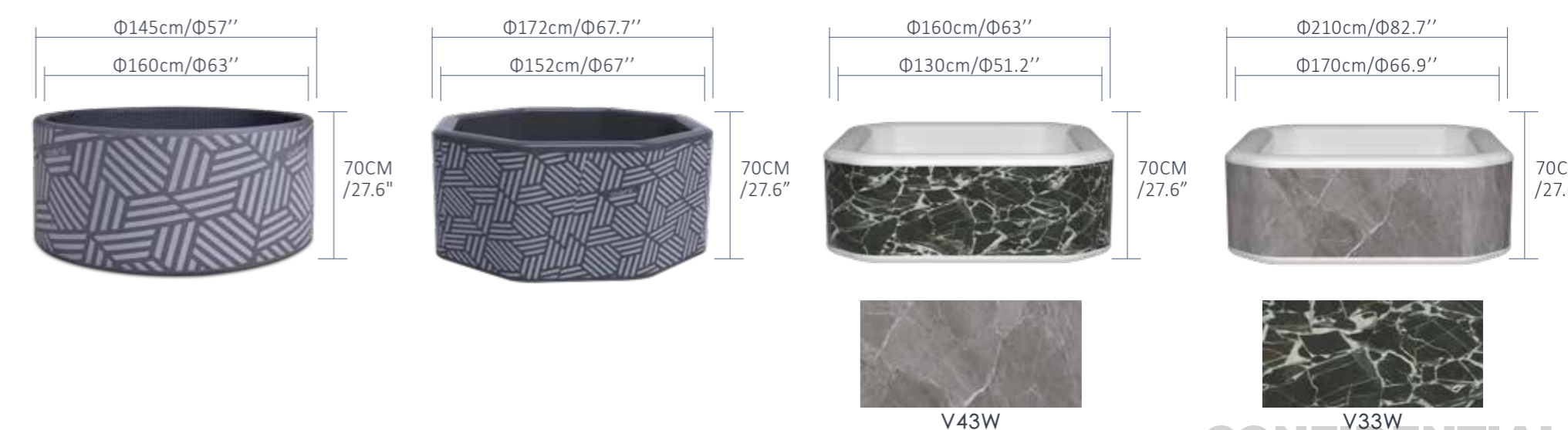

CONFIDENTIAL
PREMIUM - PAGE / 41

EcoPlus™

avenli®



Air Bubbles



Dual Heating System



Anti-bacterial Filter Cartridge X2



Lockable Cover



Base Protector



Safety Lock



ECO



3-Speeds massages



Anti-freeze



WIFI control



Timer

Anti-UV Coating Layer
Longer service Life of spas

Imitation Leather Layer
A premium and luxury feel when using spas

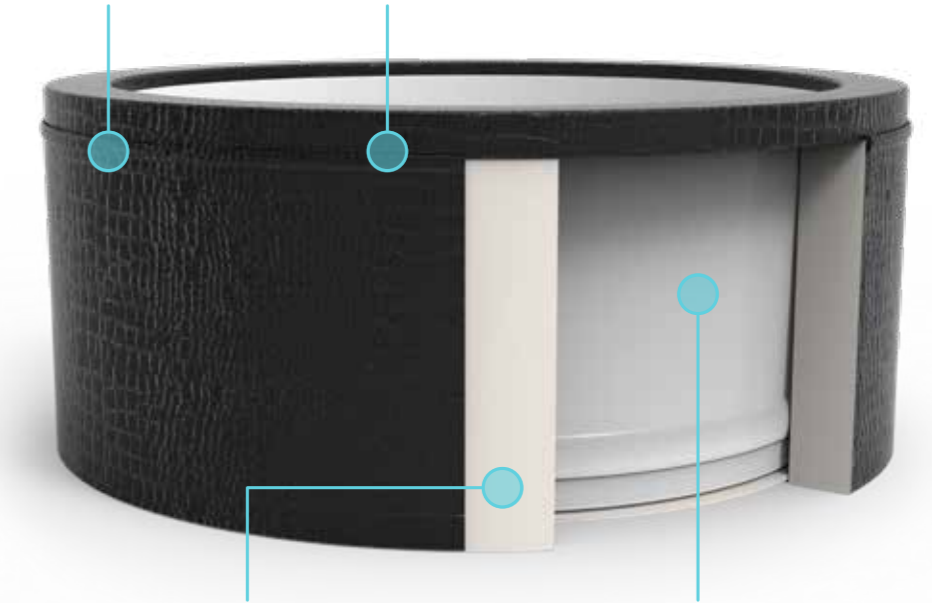

Heat Insulation Foam Layer
50% thermally efficient and energy saving

Heavy Duty Laminated Reinforced PVC layer
Extra water tight seal

- The unique non-inflatable and patented portable SPA on the market. Constructed with PE foams for quick installation in just 10 minutes.
- The inner PE foam wall with excellent thermal insulation performance for 100% energy-saving compared with normal type of spa in the same conditions.
- The artificial leather design of exterior makes the SPA more elegant.
- The SPA with increased power and the better thermal insulation performance make the heating performance 30% faster than normal types.

OPTIONAL CONFIGURATION:

- **WIFI, let you know your SPA situation at any time.**
- **Three-level massage, allowing you to have a variety of choices at different time periods.**

CONFIDENTIAL

SAIPAN

17691EU / US

- # Unique leather skin design ,Symbols luxury and enhanced the look of your spa to offer a premium decoration to your spaces
- #Foam wall of high performance thermal insulation material
- # 3-ply Laminated PVC liner more durable
- # Insulated top cover included
- # Anti-bacterial filters keeps spa water cleaner by inhibiting bacterial growth
- # Freeze Protect
- # Grounding Test
- # Waterproof PCB
- # Wifi controller and 3 massages can be option

avenli®



CONFIDENTIAL

SPECIFICATION

Control System	EU:AC 220-240V 50HZ, 2040w US:AC 110-120V 60HZ, 1380w	Certification	EU:CE; US:cETLus
Heater	2040W;1380W	Filter Pump	530GAL (2006L)
Heating Rate	EU:1.5-2.5°C/hour; US:1-2°C/hour	Bubble Jet Holes	100

Stockholm

17691EU / US

A: 60cm x 51cm x 65cm

B: 110cm x 73cm x 76cm

4-6

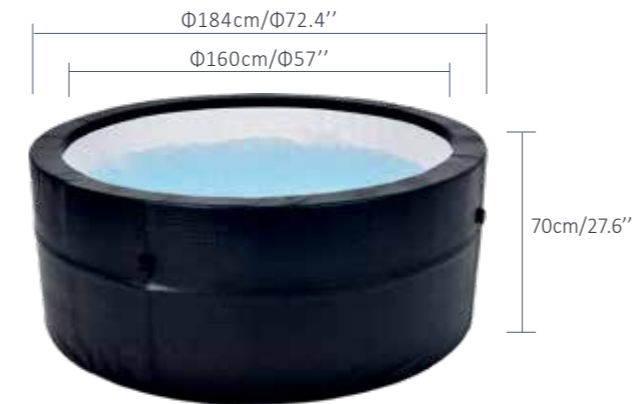

CONFIDENTIAL

ACCESSORIES— CleanPlus™

Integrated Pump

Design for Safe and Easy Use

ADVANCED DHS TECHNOLOGY

*DHS-Dual Heating System

Efficient filtration is essential for a quality swim experience. Who wants to swim in a dirty pool?

Pumps and cartridges guarantee a cleaner pool with:

- Powerful pumps in several of our most popular pool sets
- Filter cartridges with thicker, heavier paper and more pleats
- Water inlet jets for enhanced water flow back into the pool

Faster water circulation, improved filtration, and best of all – a superior swim experience!

Item No	Voltage	Power Rated	Case Pack
29P502EU	AC220-240V 50HZ	1545W	0.077cbm/ 1st/ctn
29P501EU	AC220-240V 50HZ	2045W	0.077cbm/ 1st/ctn

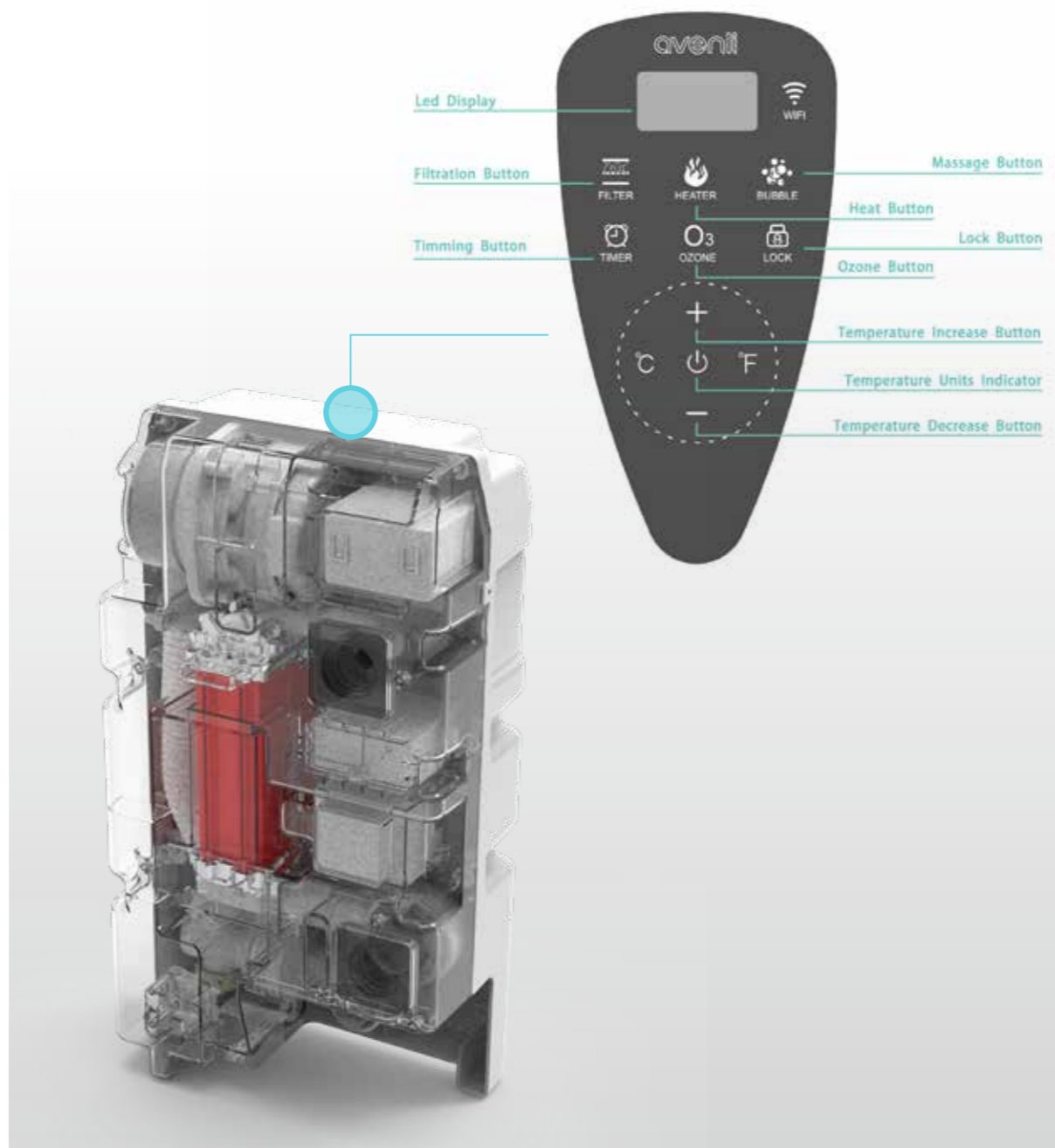

Seperated Pump

Design for Safe and Easy Use

ADVANCED DHS TECHNOLOGY

*DHS-Dual Heating System

Efficient filtration is essential for a quality swim experience. Who wants to swim in a dirty pool?

Pumps and cartridges guarantee a cleaner pool with:

- Powerful pumps in several of our most popular pool sets
- Filter cartridges with thicker, heavier paper and more pleats
- Water inlet jets for enhanced water flow back into the pool

Faster water circulation, improved filtration, and best of all – a superior swim experience!

Item No	Voltage	Power Rated	Case Pack
290757US	AC 110-120V 60HZ	1380W	0.077cbm/ 1st/ctn
290757EU	AC 220-240V 50HZ	1540w	0.077cbm/ 1st/ctn
290758EU	AC 220-240V 50HZ	2040W	0.077cbm/ 1st/ctn



CONFIDENTIAL

ACCESSORIES— CleanPlus™

Spray Brush

290495

- Size: 19.5 x 22.5 x 9cm
- Easy to clean filter cartridge
- Two function: brush or washing can be locked in auto spraying way used with a water pipe
- Clamshell
- Case pack: 0.034cbm/24pcs/ctn

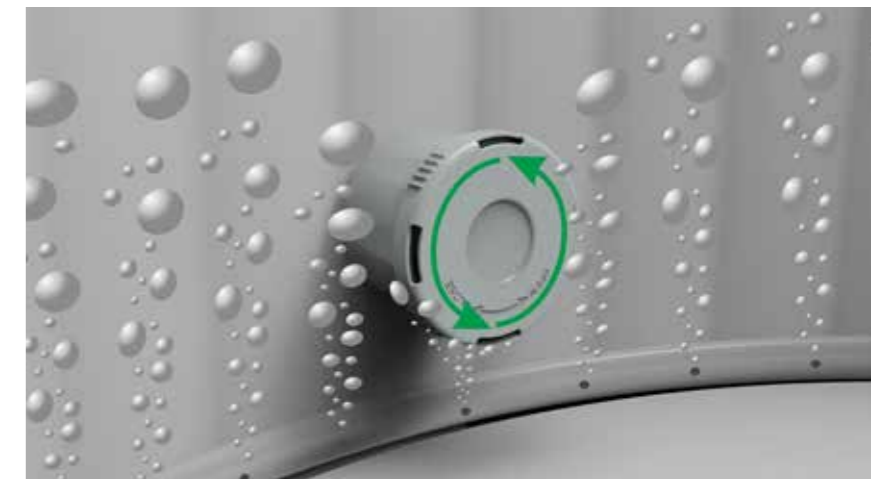

Filter Cartridge

290760

- Size: Φ 10.5x8cm
- Professional SPA filter cartridge are characterized with 150 pleats
- High water flow
- Shrink wrap
- Case pack: 0.055cbm/48pcs/ctn

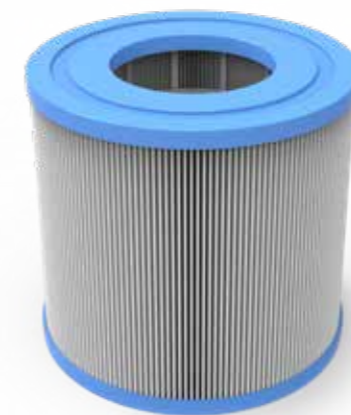

Anti-Bacterial Filter Cartridge

290802

- Size: Φ 10.5 x 8cm
- Extends the life of your filter
- Improves the quality of your water
- Neutralizes bacteria, fungi and algae and prevents their proliferation
- Shrink wrap
- Case pack: 0.055cbm/48pcs/ctn



CONFIDENTIAL

ACCESSORIES

ACCESSORIES— CleanPlus™



Cleaning Kit

290850

- The 6-in-1 Cleaning kit is the ideal SPA accessory with everything you need to keep your spa clean
- All the materials used in our cleaning kit are strictly tested and of excellent quality. all make the cleaning equipment super durable, and offer you a comfortable cleaning experience
- Color box
- Case pack: 0.028cbm/3set/ctn



Chemical Dispenser x1



Oil-absorbing Foam x1



Pad Brush x1



Brush x1



Leaf Net x1



Waterline Glove x1pc

CONFIDENTIAL

ACCESSORIES—CleanPlus™

Cleaner

290851

- 3 Section electric vacuum cleaner for spas or small soft wall above ground Pools(rechargeable)
- Color Box
- Case pack: 0.05cbm/6pcs/ctn



Test Strips

290471

- 3 in 1 free chlorine,PH,total alkalinity
- The ideal solution for basic pool and spa water testing
- Easy color-match system
- Contains 50 test strips
- 1 year shelf life
- Blister card package
- Case pack: 0.020cbm/48pcs/ctn



Chemical Floater

290468

- Dia.5" floating chemical dispenser
- Dispenses 1" chemical tablets
- Adjustable dial to control the release of chemicals
- contractive construction
- No tablets included
- Shrink wrapped with insert card
- Case pack: 0.028cbm/24pcs/ctn



ACCESSORIES—Energy Saving



14023

- For 3P Square SPA
- Color box
- Size: 115x115x20cm
- Case pack: 0.034cbm/4pcs/ctn



14024

- For 4P Square SPA
- Color box
- Size: 130x130x20cm
- Case pack: 0.039cbm/4pcs/ctn



14029

- For 6P Square SPA
- Color box
- Size: 170x170x20cm
- Case pack: 0.069cbm/4pcs/ctn



Inflatable Lid

- Heavy-duty PVC
- Help the temperature of spa water to become warm faster
- Save 20% electric energy
- Compact storage measurement is convenient to transport
- Easy to set up

14017

- For 3P Round SPA
- Color box
- Size: Φ125 x 18cm
- Case pack: 0.032cbm/4pcs/ctn



14018

- For 4P Round SPA
- Color box
- Size: Φ135 x 18cm
- Case pack: 0.034cbm/4pcs/ctn



14019

- For 6P Round SPA
- Color box
- Size: Φ160 x 18cm
- Case pack: 0.045cbm/4pcs/ctn



14020

- For 6P Octagon SPA
- Color box
- Size: 154 x 154 x 18cm
- Case pack: 0.045cbm/4pcs/ctn



CONFIDENTIAL

ACCESSORIES

ACCESSORIES—Comfort&Feel

Headrest & Cup Holder Set For Inflatable Spa

290410

- Size: 16.8 x 24.2 x 24.5cm/25 x 22.5 x 23cm
- TPU
- For Bali/ London/ Vancouver/ Nice/ Venice spa
- Color box: 1 cup holder & 2 headrests
- Case pack: 0.051cbm/2set/ctn



Headrest with Cup Holder For Osaka/Saipan Spa

290671

- Size: 27 x 16 x 19cm
- TPU
- 1 headrest with cup holders
- Color box: 2 headrests/set
- Case pack: 0.054cbm/4set/ctn



NEW

Aromatherapy Port

395169

- Easy place in your spa pump
- Included the 1 beads
- Relax your mind and body
- Not effect the chemistry of the SPA water
- Color box
- Case pack: 0.099cbm/100pcs/ctn

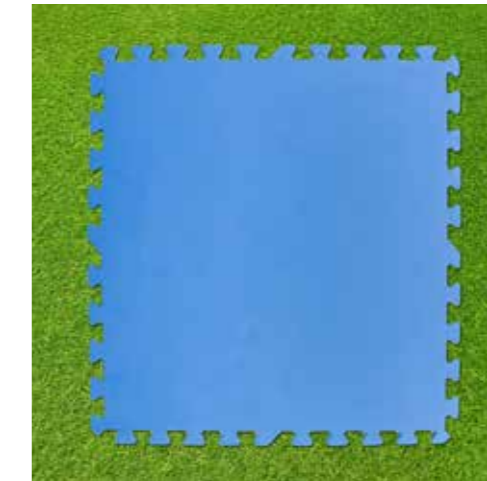

Pool/Spa Floor Protector

290972

- Size: 55x55x0.4cm
- High temperature resistant PE
- material makes the bottom of the pool softer.
- Give extra protection to your pool bottom.
- Shrink wrap with insert card package.
- Various colors available
- Case pack: 0.156cbm/108pcs/ctn

LED Lamp

290795

- Size: Φ8 x 6.5cm
- Easy to operate
- Easy battery installation
- Floating design
- Light can be used in water indoor & outdoor and playtime
- Color box
- Case pack: 53 x 43 x 22cm/40pcs/ctn
- Weight: 6.5kg (14.3lb)



CONFIDENTIAL

ACCESSORIES—*Comfort&Feel*

Foot Basin

137205-1

- Size: 87 x 68 x 14cm (34" x 27" x 5.5")
- 10ga.(0.25mm) PVC
- Repair patch,Color box
- Case pack: 0.026cbm/12pcs/ctn



Seat Cushion

97265

- Size: 50 x 35 x 11 cm (19.7" x 13.8" x 4.3")
- 10ga.(0.25mm) PVC
- Insert card with poly bag
- Case pack: 0.037cbm/24pcs/ctn



RANK	AIO			Classic			Premium					EcoPlus™	RANK
PICTURE													PICTURE
NAME	Boston	Chicago	Chicago	London	Vienna	Madrid	Nice	Milan	Victory	Oslo	Bergen	Saipan	NAME
ITEM NO	14015EU V43	14016EU	14014EU	17612EU/US	17283EU/US V13	17654EU/US V32	17286EU/US V 31	17660EU/US V 01	17665EU/US V01	14030EU/US V 33W	14028EU/US V 43W	17691EU/US	ITEM NO
PATTERN OPTIONAL	V31 / V32	/	V31 / V32	/	V31 / V32 / V33	V13 / V31 / V33	V13 / V32 / V33	/	/	V43W	V33W	/	PATTERN OPTIONAL
TECHNIQUE	Built in pump + 1 beam	Built in pump + 1 beam	Built in pump + 1 beam	1 beam	1 beam	1 beam	1 beam	Drop Stitch				PE foam	TECHNIQUE
	(3-ply laminated PVC)	(3-ply laminated PVC)	(3-ply laminated PVC)	(3-ply laminated PVC)	(3-ply laminated PVC)	(3-ply laminated PVC)	(3-ply laminated PVC)	(5 cm thickness)	(10 cm thickness)	(15 cm thickness)	(20 cm thickness)	(rattan outer)	
SEATING CAPACITY	2-3 PLACES	2-3 PLACES	4-6 PLACES	2-3 PLACES	2-4 PLACES	3-5 PLACES	4-6 PLACES	2-4 PLACES	3-5 PLACES	2-4 PLACES	4-6 PLACES	4-6 PLACES	SEATING CAPACITY
WATER CAPACITY	580L (153gal)	650L(172gal)	1000L (264gal)	686L(181gal)	800L(211gal)	800L(211gal)	1000L (264gal)	800L (211gal)	940L(248gal)	760L(201GAL)	1300L(343gal)	1200L(317gal)	WATER CAPACITY
POWER RATED	EU:AC 220-240V 50HZ, 1545w	EU:AC 220-240V 50HZ, 1545w	EU:AC 220-240V 50HZ, 1545w	EU:AC 220-240V 50HZ, 1540w	EU:AC 220-240V 50HZ, 1540w	EU:AC 220-240V 50HZ, 1540w	EU:AC 220-240V 50HZ, 1540w	EU:AC 220-240V 50HZ, 1540w	EU:AC 220-240V 50HZ, 1540w	EU:AC 220-240V 50HZ, 2040w	EU:AC 220-240V 50HZ, 2040w	EU:AC 220-240V 50HZ, 2040w	POWER RATED
				US:AC 110-120V 60HZ, 1380w	US:AC 110-120V 60HZ, 1380w	US:AC 110-120V 60HZ, 1380w	US:AC 110-120V 60HZ, 1380w	US:AC 110-120V 60HZ, 1380w	US:AC 110-120V 60HZ, 1380w	US:AC 110-120V 60HZ, 1380w	US:AC 110-120V 60HZ, 1380w	US:AC 110-120V 60HZ, 1380w	
HEATING RATE	EU:1.5-2.5°C/hour	EU:1.5-2.5°C/hour	EU:1-2°C/hour	EU:1.5-2.5°C/hour	EU:1.5-2.5°C/hour	EU:1.5-2.5°C/hour	EU:1-2°C/hour	EU:1.5-2.5°C/hour	EU:1.5-2.5°C/hour	EU:1.5-2.5°C/hour	EU:1-2°C/hour	EU:1.5-2.5°C/hour	HEATING RATE
				US:1-2°C/hour	US:1-2°C/hour	US:1-2°C/hour	US:0.5-1.5°C/hour	US:1-2°C/hour	US:1-2°C/hour	US:1-2°C/hour	US:1-2°C/hour	US:0.5-1.5°C/hour	
SYSTEM FLOW RATE	530GAL(2006L)/H	530GAL(2006L)/H	530GAL(2006L)/H	530GAL(2006L)/H	530GAL(2006L)/H	530GAL(2006L)/H	530GAL(2006L)/H	530GAL(2006L)/H	530GAL(2006L)/H	530GAL(2006L)/H	530GAL(2006L)/H	530GAL(2006L)/H	SYSTEM FLOW RATE
MESSAGE BUBBLE POWER	650W	650W	650W	650W	650W	650W	650W	650W	650W	650W	650W	650W	MESSAGE BUBBLE POWER
CERTIFICATION	EU: CE	EU: CE	EU: CE	EU:CE/GS	EU:CE/GS	EU:CE/GS	EU:CE/GS	EU:CE	EU:CE	EU:CE/GS	EU:CE	EU:CE/GS	CERTIFICATION
				US:cETLus	US:cETLus	US:cETLus	US:cETLus	US:cETLus	US:cETLus	US:cETLus	US:cETLus	US:cETLus	
OUTER DIAMETER	148cm x 148cm x 65cm	Φ165cm x 65cm	Φ204cm x 65cm	Φ165cm x 70cm	Φ175cm x 70cm	195cm x 195cm x 70cm	Φ204cm x 70cm	Φ145cm x 70cm	Φ172cm x 70cm	160cm x 160cm x 70cm	210cm x 210cm x 70cm	Φ184cm x 73cm	OUTER DIAMETER
	(58.3" x 58.3" x 25.6")	(65" x 25.6")	(80.3" x 25.6")	(65" x 27.6")	(68.9" x 27.6")	(76.8" x 76.8" x 27.6")	(80.3" x 27.6")	(57.1" x 27.6")	(67.7" x 27.6")	(63" x 63" x 27.6")	(82.7" x 82.7" x 27.6")	(72.4" x 28.7")	
INNER DIAMETER	115cm x 115cm x 65cm	Φ135cm x 65cm	Φ170cm x 65cm	Φ125cm x 70cm	Φ135cm x 70cm	154cm x 154cm x 70cm	Φ160cm x 70cm	Φ135cm x 70cm	Φ152cm x 70cm	130cm x 130cm x 70cm	170cm x 170cm x 70cm	Φ160cm x 70cm	INNER DIAMETER
	(45.3" x 45.3" x 25.6")	(53.1" x 25.6")	(66.9" x 25.6")	(49.2" x 27.6")	(53.1" x 27.6")	(60.6" x 60.6" x 27.6")	(63" x 27.6")	(53.1" x 27.6")	(59.8" x 27.6")	(51.2" x 51.2" x 27.6")	(66.9" x 66.9" x 27.6")	(63" x 27.6")	
BUBBLE JET HOLES	114	108	138	105	110	120	140	90	90	70	100	90	BUBBLE JET HOLES
BOX SIZE	68cm x 38cm x 57.5cm	68cm x 38cm x 57.5cm	68cm x 40cm x 57.5cm	61.5cm x 45cm x 57.5cm	63cm x 56.5cm x 57.5cm	63cm x 56.5cm x 57.5cm	68.5cm x 63cm x 57.5cm	60cm x 54.5cm x 64cm	70cm x 45.5cm x 64cm	70cm x 45.5cm x 64cm	70cm x 60cm x 57.5cm	A: 60cmX51cmX65cm B: 110cm x 73cm x 76cm	BOX SIZE
CASE PACK	0.170cbm/1set/1ctn	0.170cbm/1set/1ctn	0.201cbm/1set/1ctn	0.243cbm/1set/1ctn	0.201cbm/1set/1ctn	0.201cbm/1set/1ctn	0.243cbm/1set/1ctn	0.200cbm /1set /1c tn	0.211cbm /1set /1c tn	0.211cbm /1set /1c tn	0.513cbm/1set /1c tn	0.84cbm/1set /2c tn	CASE PACK
1x20 CTNS	155	155	130	110	130	130	110	135	125	125	50	30	1x20 CTNS
1x40 CTNS	335	335	280	230	280	280	230	285	270	270	110	65	1x40 CTNS
1x40HQ CTNS	411	411	336	272	336	336	272	320	332	332	115	84	1x40HQ CTNS

CONFIDENTIAL