

LEDFHB-V2 Full-Body LED High Bay

Project:	
Type:	
Catalog #:	

STANDARD



FEATURES

- Available in 4000k (neutral white) and 5000k (cool white) color temperatures.*
- Long-life LEDs provide 122,000 hours of operation with at least 70% of initial lumen output (L₇₀).**
- Delivers from 12,193 lumens (140 lumens per watt, LPW) to 60,629 lumens (142 LPW).*
- 0-10vdc dimming drivers are standard. See list of compatible dimmers (page 2).
- Power factor > 0.90.
- Total harmonic distortion < 20%.
- Color rendering index > 80.
- Painted steel housings are standard.
- Chain-mount kits (includes v-hooks and 1/8" thick, 1-meter long chain) are standard.
- Accessories include lenses (clear & diffused), wire-guard kits, surface-mounting kits, pendant-mounting kits, and cable-mounting kits.
- Easy installation in new construction or retrofit.

* Contact factory for other color temperatures and lumen packages.

** L₇₀ hours are IES TM-21-11 calculated hours.



WARRANTY & LISTINGS

- cULus listed for damp locations in ambient temperatures from -20°C to 50°C (-4°F to 122°F).
- DLC approved.
- Flicker-free per IEEE1789-2015 (low risk of adverse effects of flicker at 100% light output level).
- Complies with RoHS (Restriction on Hazardous Substances) requirements.
- Complies with FCC Part 15, class A.
- Complies with IEEE C.62.41-1991, input transient protection (2.5kV).
- 5-year warranty of all electronics and housing.

MOUNTING OPTIONS

- Chain mounting with V-hooks is standard.
- Optional surface mounting kits provides attachment to flat ceilings.*
- Optional pendant mounting kits provides pendant attachment to junction boxes.
- Optional cable mounting kits provide suspension at two lengths (i.e., 3 & 5 meters).

* Not compatible with 347-480V models or emergency drivers.

ORDERING INFORMATION

Example: LEDFHB180-5K-MVDIM-V2-OS-EM20

Model	Color Temperature		Voltage		Series	Occupancy Sensor ¹²³		Emergency Driver ⁴⁵⁶	
	4K	5000k	MVDIM	120-277V		OS	Passive infrared	EM12	1200 lumens
LEDFHB90	4K	4000k	MVDIM	120-277V	V2	OS	Passive infrared	EM12	1200 lumens
LEDFHB135	5K	5000k	UNC	347-480V		ODS	Microwave	EM16	1600 lumens
LEDFHB180						Blank	No occupancy sensor	EM20	2000 lumens
LEDFHB215								EM24	2400 lumens
LEDFHB265								EC12	1200 lumens
LEDFHB320								EC16	1600 lumens
LEDFHB425								EC20	2000 lumens
								EC24	2400 lumens
								Blank	No emergency driver

¹ Sensors available for 120-277V models only.

² Contact factory for other sensors.

³ Luminaires with the OS sensor installed have a maximum mounting height of 26 FT.

⁴ Emergency drivers available for 120-277V models only.

⁵ See list of emergency drivers (page 2).

⁶ EC emergency drivers are California Energy Commission (CEC) listed.

LED FHB-V2 Full-Body LED High Bay

Compatible Emergency Drivers

Emergency Driver Part Number	EM12 / EC12		EM16 / EC16		EM20 / EC20		EM24 / EC24		Runtime
	Model	Watts	EM Lumens	Watts	EM Lumens	Watts	EM Lumens	Watts	
LED FHB90	7.8	1092	10.7	1498	13.7	1918	17.0	2380	90 MINS.
LED FHB135	7.8	1084	10.7	1487	13.7	1904	17.0	2363	
LED FHB180	7.8	1092	10.7	1498	13.7	1918	17.0	2380	
LED FHB215	7.8	1100	10.7	1509	13.7	1932	17.0	2397	
LED FHB265	7.8	1100	10.7	1509	13.7	1932	17.0	2397	
LED FHB320	7.8	1076	10.7	1477	13.7	1891	17.0	2346	
LED FHB425	7.8	1084	10.7	1487	13.7	1904	17.0	2363	

Compatible Dimmers

Manufacture	Model Number	Dimming Range	Load Switching Capacity
Lutron	DVSTV	10%-100%	450W
Leviton	IP710-LFZ	10%-100%	1200W
General Protecht	DMD-LED3-102	10%-100%	600W

Accessories

Lens

LED FHB-CRLENS-12X23	=	Clear lens – 90W, 135W & 180W
LED FHB-CRLENS-17X23	=	Clear lens – 215W
LED FHB-CRLENS-12X45	=	Clear lens – 265W & 320W
LED FHB-CRLENS-17X45	=	Clear lens – 425W
LED FHB-DIFLENS-12X23	=	Diffuse lens – 90W, 135W & 180W
LED FHB-DIFLENS-17X23	=	Diffuse lens – 215W
LED FHB-DIFLENS-12X45	=	Diffuse lens – 265W & 320W
LED FHB-DIFLENS-17X45	=	Diffuse lens – 425W

Wire Guard

LED FHB-WG-12X23	=	Wire-guard kit – 90W, 135W & 180W
LED FHB-WG-17X23	=	Wire-guard kit – 215W
LED FHB-WG-12X45	=	Wire-guard kit – 265W & 320W
LED FHB-WG-17X45	=	Wire-guard kit – 425W

Mounting Options

LED FHB-SMK-12.625WIDE	=	Surface-mount kit – 90W, 135W, 180W, 265W & 320W
LED FHB-SMK-17.25WIDE	=	Surface-mount kit – 215W & 425W
LED FHB-PMK	=	Pendant-mount kit – 90W, 135W, 180W, 265W, 320W, & 425W
LED FHB-PMK8	=	Pendant-mount kit – 215W
LED FHB-CMK3	=	Cable-mounting kit, 3 meters long
LED FHB-CMK5	=	Cable-mounting kit, 5 meters long

LED FHB-V2 Full-Body LED High Bay

ELECTRICAL DATA

Model	Color Temp.	CRI ¹	Luminaire Lumens	Luminaire Watts	Lumens/Watt	Input Voltage ²	Input Current (A)			Power Factor	THD ³	L ₇₀ Hours ⁴
							120V	240V	277V			
LED FHB90-4K-MVDIM-V2	4000k	>80	12,193	87	140	120-277	0.73	0.36	0.31	>90%	<20%	122,000
LED FHB90-5K-MVDIM-V2	5000k	>80	12,394	87	142	120-277	0.73	0.36	0.31	>90%	<20%	122,000
LED FHB135-4K-MVDIM-V2	4000k	>80	18,401	132	139	120-277	1.10	0.55	0.48	>90%	<20%	122,000
LED FHB135-5K-MVDIM-V2	5000k	>80	18,564	132	141	120-277	1.10	0.55	0.48	>90%	<20%	122,000
LED FHB180-4K-MVDIM-V2	4000k	>80	24,457	175	140	120-277	1.46	0.73	0.63	>90%	<20%	122,000
LED FHB180-5K-MVDIM-V2	5000k	>80	24,603	175	141	120-277	1.46	0.73	0.63	>90%	<20%	122,000
LED FHB215-4K-MVDIM-V2	4000k	>80	29,929	213	141	120-277	1.78	0.89	0.77	>90%	<20%	122,000
LED FHB215-5K-MVDIM-V2	5000k	>80	30,356	213	143	120-277	1.78	0.89	0.77	>90%	<20%	122,000
LED FHB265-4K-MVDIM-V2	4000k	>80	37,590	267	141	120-277	2.23	1.11	0.96	>90%	<20%	122,000
LED FHB265-5K-MVDIM-V2	5000k	>80	37,996	267	142	120-277	2.23	1.11	0.96	>90%	<20%	122,000
LED FHB320-4K-MVDIM-V2	4000k	>80	44,235	320	138	120-277	2.67	1.33	1.16	>90%	<20%	122,000
LED FHB320-5K-MVDIM-V2	5000k	>80	44,460	320	139	120-277	2.67	1.33	1.16	>90%	<20%	122,000
LED FHB425-4K-MVDIM-V2	4000k	>80	59,278	428	139	120-277	3.57	1.78	1.55	>90%	<20%	122,000
LED FHB425-5K-MVDIM-V2	5000k	>80	60,629	428	142	120-277	3.57	1.78	1.55	>90%	<20%	122,000

¹ Color rendering index.

² All 50-60Hz.

³ Total harmonic distortion.

⁴ L₇₀ refers to the number of hours at which lumen output declines to 70% of the initial level. L₇₀ hours are IES TM-21-11 calculated hours.

PHOTOMETRIC DATA

LED FHB90-5K-MVDIM-V2 (12,394 Lumens)

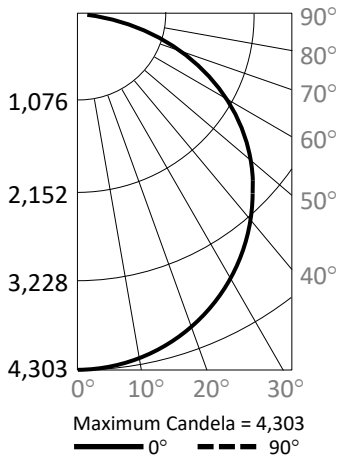

Candlepower Summary

	0°	90°
0°	4,303	4,303
10°	4,274	4,302
20°	4,110	4,154
30°	3,767	3,822
40°	3,305	3,385
50°	2,713	2,841
60°	1,987	2,179
70°	1,176	1,045
80°	385	268
90°	0	0

Zonal Lumen Summary

Zone	Lumens	% Fixture
0° – 10°	406	3.3%
0° – 20°	1,582	12.8%
0° – 30°	3,397	27.4%
0° – 40°	5,614	45.3%
0° – 50°	7,947	64.1%
0° – 60°	10,069	81.2%
0° – 70°	11,644	94.0%
0° – 80°	12,313	99.3%
0° – 90°	12,394	100.0%
90° – 180°	0	0.0%
0° – 180°	12,394	100.0%

Cone of Light

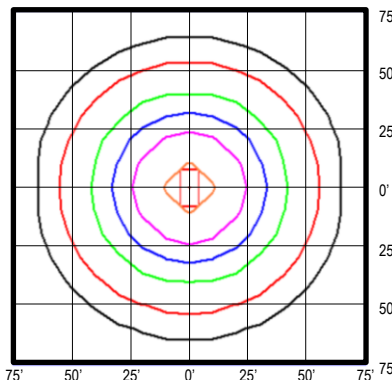
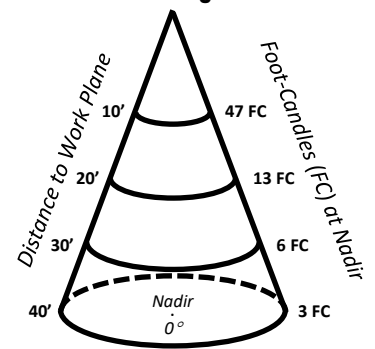

Foot Candles

- 5.0
- 2.0
- 1.0
- 0.5
- 0.2
- 0.1

Notes:

- Isofootcandle plots depict initial foot-candles at grade.
- Gridlines represent units of mounting height of 25 feet.

LED FHB-V2 Full-Body LED High Bay

PHOTOMETRIC DATA

LED FHB135-5K-MVDIM-V2 (18,564 Lumens)

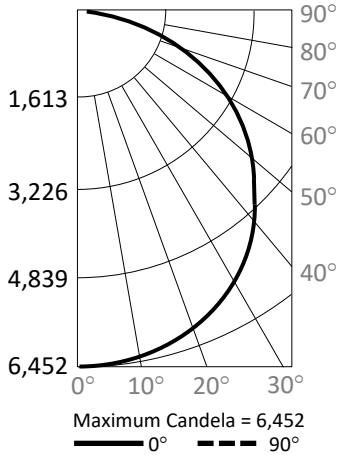

Candlepower Summary

	0°	90°
0°	6,452	6,452
10°	6,398	6,438
20°	6,143	6,215
30°	5,642	5,845
40°	4,948	5,133
50°	4,066	4,265
60°	3,003	3,257
70°	1,772	1,305
80°	580	300
90°	0	0

Zonal Lumen Summary

Zone	Lumens	% Fixture
0° - 10°	610	3.3%
0° - 20°	2,377	12.8%
0° - 30°	5,110	27.5%
0° - 40°	8,470	45.6%
0° - 50°	11,998	64.6%
0° - 60°	15,214	82.0%
0° - 70°	17,465	94.1%
0° - 80°	18,441	99.3%
0° - 90°	18,564	100.0%
90° - 180°	0	0.0%
0° - 180°	18,564	100.0%

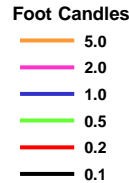
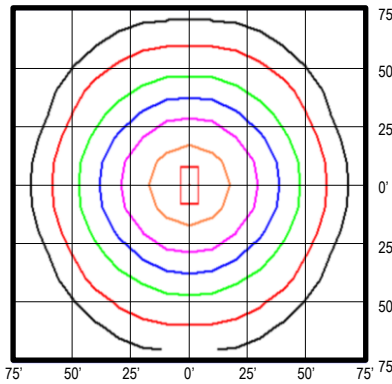
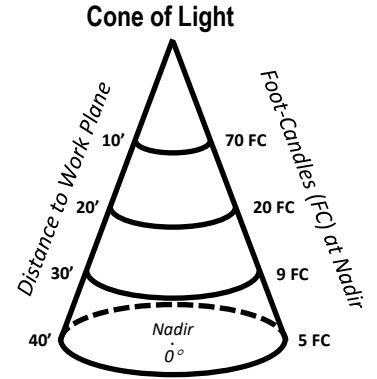

Notes:

- Isofootcandle plots depict initial foot-candles at grade.
- Gridlines represent units of mounting height of 25 feet.

LED FHB180-5K-MVDIM-V2 (24,603 Lumens)

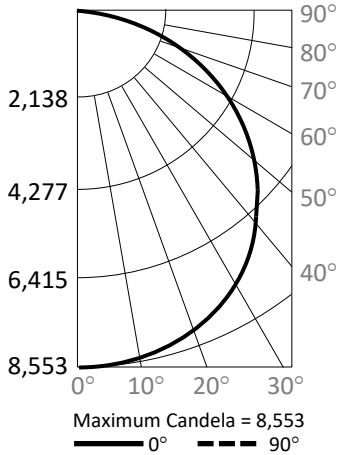

Candlepower Summary

	0°	90°
0°	8,553	8,553
10°	8,487	8,480
20°	8,173	8,255
30°	7,487	7,759
40°	6,581	6,870
50°	5,425	5,678
60°	3,993	3,802
70°	2,383	2,084
80°	808	346
90°	0	0

Zonal Lumen Summary

Zone	Lumens	% Fixture
0° - 10°	809	3.3%
0° - 20°	3,155	12.8%
0° - 30°	6,787	27.6%
0° - 40°	11,259	45.8%
0° - 50°	15,964	64.9%
0° - 60°	20,185	82.0%
0° - 70°	23,093	93.9%
0° - 80°	24,441	99.3%
0° - 90°	24,603	100.0%
90° - 180°	0	0.0%
0° - 180°	24,603	100.0%

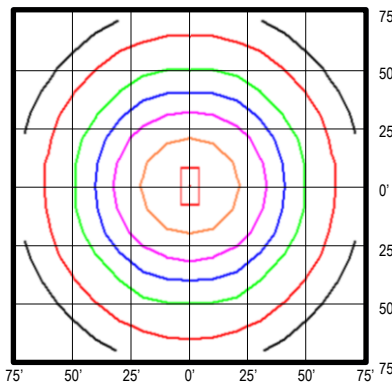
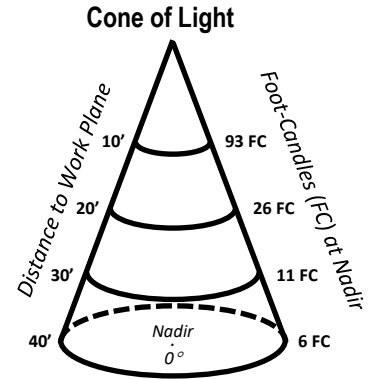

Notes:

- Isofootcandle plots depict initial foot-candles at grade.
- Gridlines represent units of mounting height of 25 feet.

LED FHB-V2 Full-Body LED High Bay

PHOTOMETRIC DATA

LED FHB215-5K-MVDIM-V2 (30,356 Lumens)

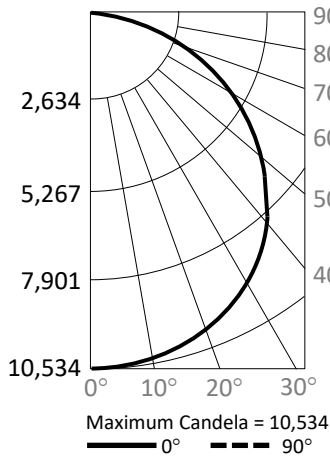

Candlepower Summary

	0°	90°
0°	10,534	10,534
10°	10,446	10,436
20°	10,036	10,119
30°	9,191	9,493
40°	8,048	8,416
50°	6,605	7,015
60°	4,857	4,897
70°	2,885	2,838
80°	972	560
90°	0	0

Zonal Lumen Summary

Zone	Lumens	% Fixture
0° - 10°	993	3.3%
0° - 20°	3,870	12.7%
0° - 30°	8,310	27.4%
0° - 40°	13,770	45.4%
0° - 50°	19,513	64.3%
0° - 60°	24,683	81.3%
0° - 70°	28,355	93.4%
0° - 80°	30,118	99.2%
0° - 90°	30,356	100.0%
90° - 180°	0	0.0%
0° - 180°	30,356	100.0%

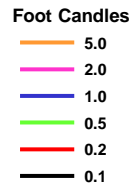
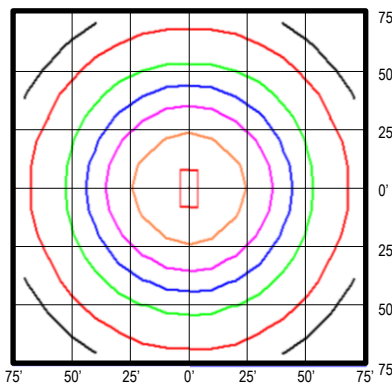
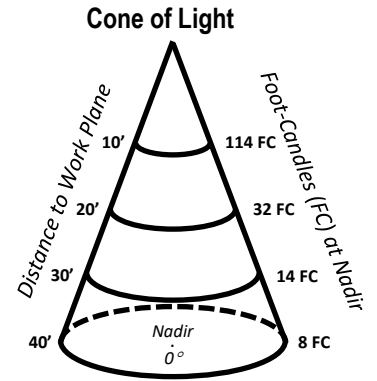

Notes:

- Isofootcandle plots depict initial foot-candles at grade.
- Gridlines represent units of mounting height of 25 feet.

LED FHB265-5K-MVDIM-V2 (37,996 Lumens)

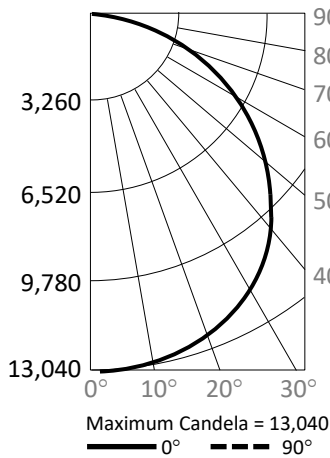

Candlepower Summary

	0°	90°
0°	13,040	13,040
10°	12,940	12,943
20°	12,450	12,545
30°	11,488	11,728
40°	10,159	10,193
50°	8,449	8,458
60°	6,305	5,687
70°	3,864	2,705
80°	1,376	592
90°	0	0

Zonal Lumen Summary

Zone	Lumens	% Fixture
0° - 10°	1,234	3.2%
0° - 20°	4,813	12.7%
0° - 30°	10,349	27.2%
0° - 40°	17,160	45.2%
0° - 50°	24,351	64.1%
0° - 60°	30,907	81.3%
0° - 70°	35,544	93.5%
0° - 80°	37,692	99.2%
0° - 90°	37,991	100.0%
90° - 180°	5	0.0%
0° - 180°	37,996	100.0%

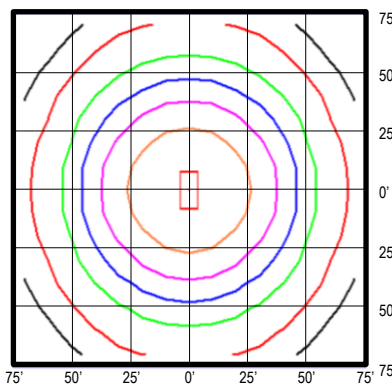
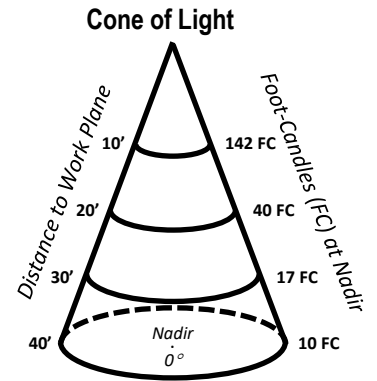

Notes:

- Isofootcandle plots depict initial foot-candles at grade.
- Gridlines represent units of mounting height of 25 feet.

LED FHB-V2 Full-Body LED High Bay

PHOTOMETRIC DATA

LED FHB320-5K-MVDIM-V2 (44,460 Lumens)

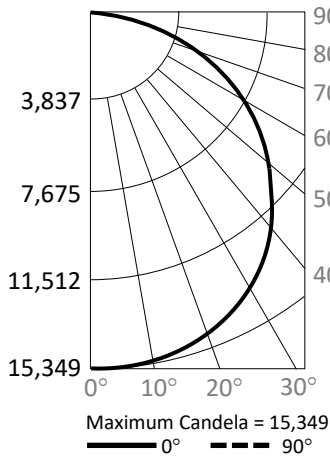

Candlepower Summary

	0°	90°
0°	15,349	15,349
10°	15,202	15,293
20°	14,607	14,738
30°	13,474	13,773
40°	11,901	12,003
50°	9,818	10,013
60°	7,312	6,602
70°	4,456	3,264
80°	1,578	701
90°	0	0

Zonal Lumen Summary

Zone	Lumens	% Fixture
0° - 10°	1,453	3.3%
0° - 20°	5,665	12.7%
0° - 30°	12,168	27.4%
0° - 40°	20,153	45.3%
0° - 50°	28,564	64.2%
0° - 60°	36,216	81.5%
0° - 70°	41,604	93.6%
0° - 80°	44,106	99.2%
0° - 90°	44,456	100.0%
90° - 180°	4	0.0%
0° - 180°	44,460	100.0%

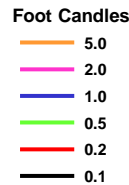
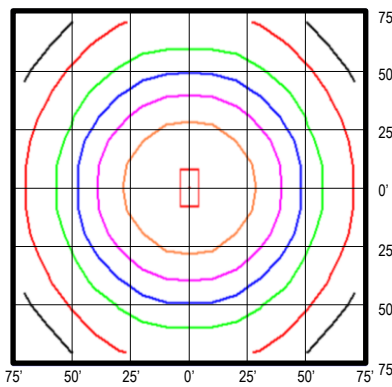
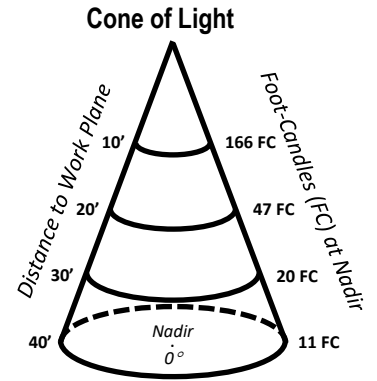

Notes:

- Isofootcandle plots depict initial foot-candles at grade.
- Gridlines represent units of mounting height of 25 feet.

LED FHB425-5K-MVDIM-V2 (60,629 Lumens)

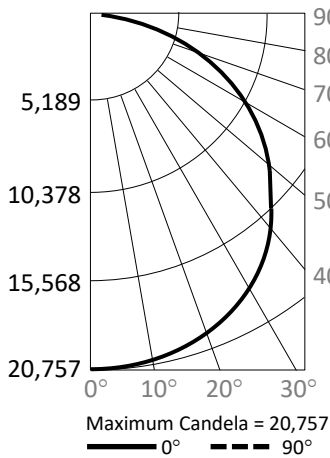

Candlepower Summary

	0°	90°
0°	20,757	20,757
10°	20,548	20,583
20°	19,742	19,889
30°	18,239	18,567
40°	16,086	16,566
50°	13,307	13,877
60°	9,917	9,531
70°	5,987	5,317
80°	2,089	1,138
90°	0	30

Zonal Lumen Summary

Zone	Lumens	% Fixture
0° - 10°	1,962	3.2%
0° - 20°	7,645	12.6%
0° - 30°	16,413	27.1%
0° - 40°	27,217	44.9%
0° - 50°	38,652	63.8%
0° - 60°	49,008	80.8%
0° - 70°	56,412	93.0%
0° - 80°	60,036	99.0%
0° - 90°	60,600	100.0%
90° - 180°	29	0.0%
0° - 180°	60,629	100.0%

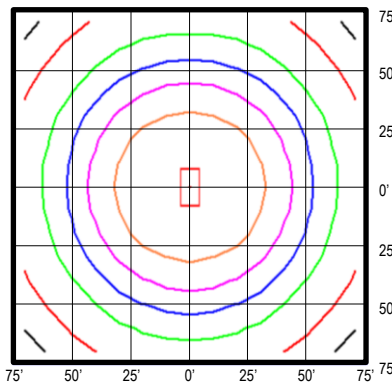
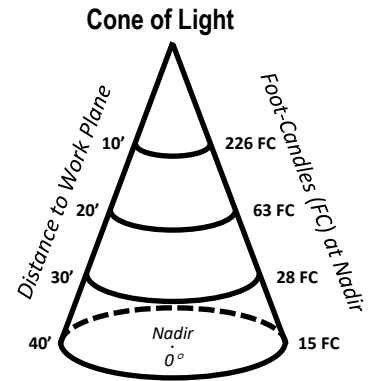

Notes:

- Isofootcandle plots depict initial foot-candles at grade.
- Gridlines represent units of mounting height of 25 feet.

LED FHB-V2 Full-Body LED High Bay

DIMENSIONS

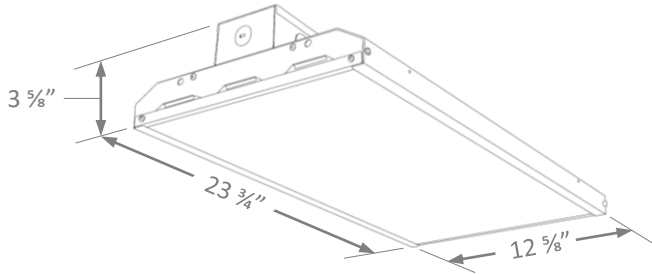

90 – 180W Models
(9.9 – 11.0 lbs.)

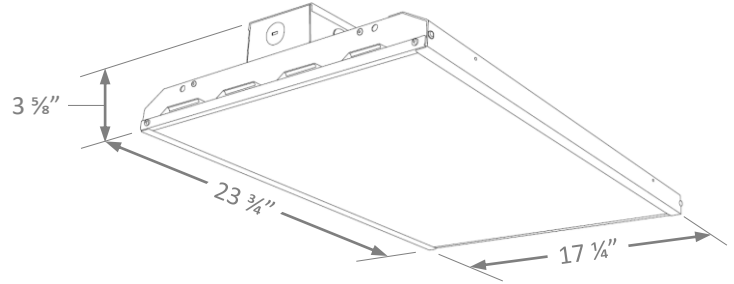

215W Model
(14.0 lbs.)

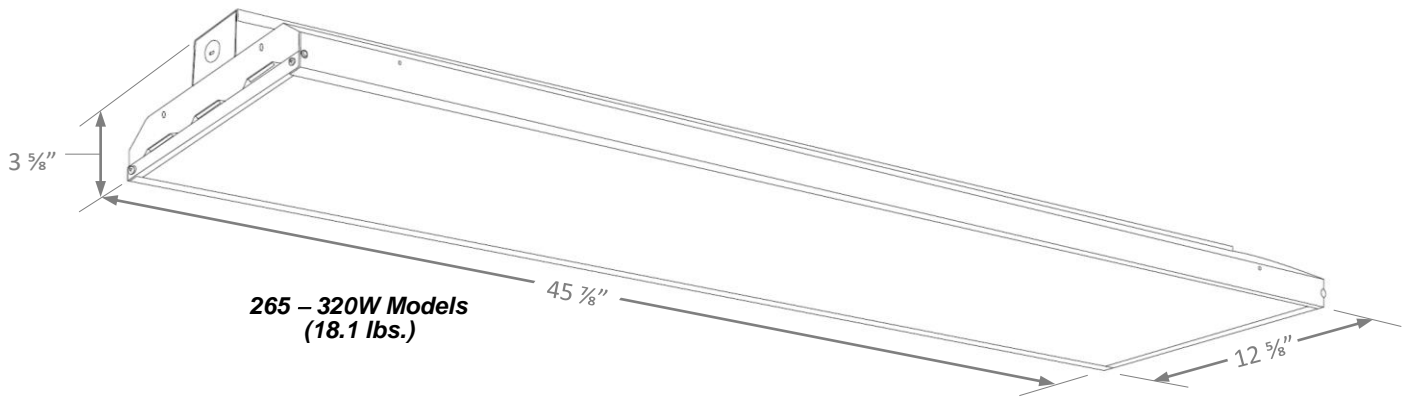

265 – 320W Models
(18.1 lbs.)

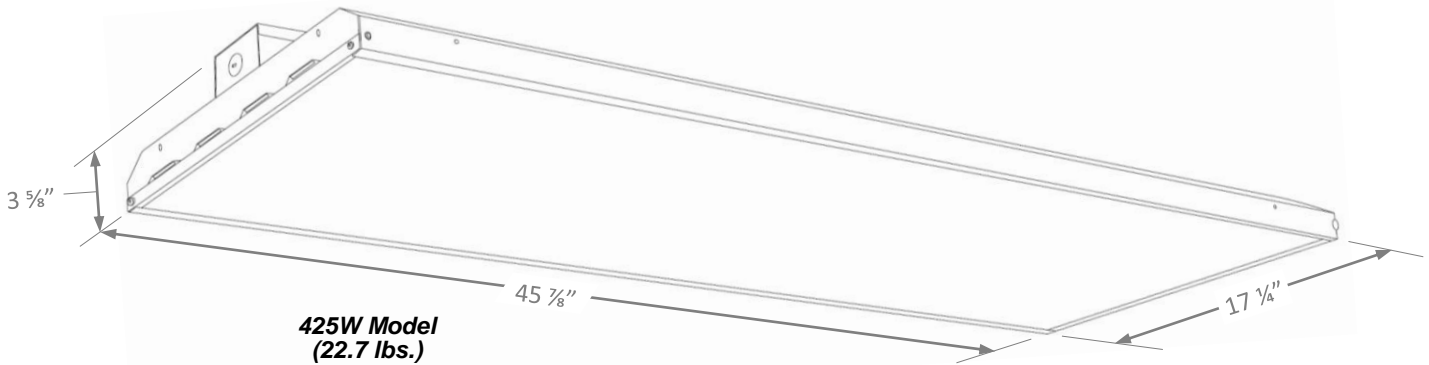

425W Model
(22.7 lbs.)