

Thank you for selecting the Photonic Universe BW series waterproof solar charge controller. Please read this manual carefully before using the product, paying close attention to the safety information provided.

Photonic Universe BW Series Solar Charge Controller

1. Safety Information

- Read the instruction manual in full before beginning the installation.
- Do not disassemble or attempt to repair the controller.
- Install the controller in a well-ventilated place to ensure adequate heat dissipation from the controller.
- Install appropriate external fuses/breakers as recommended.
- Remove all connections between the controller and the battery / PV array or disconnect the appropriate fuses/breakers before installing or moving the controller.
- Power connections must remain tight to avoid excessive heating from a loose connection.
- Only charge lead acid batteries that comply with the parameters of the controller.
- Battery connection may be wired to one battery or a bank of batteries.

2. Overview

The Photonic Universe BW series waterproof controller combines innovative PWM technology with advanced communication features. Parameters can be programmed via a remote meter MT50, a mobile device using a mobile app, a PC using software, or via a remote wireless collector. The multiple load control modes allow a high degree of personalisation for a wide range of applications such as solar home systems, traffic signaling, lighting, fans etc. Key features include:

- 12/24VDC automatic system voltage recognition
- 3-Stage intelligent PWM charging: Bulk, Boost/Equalize, Float
- Supports 4 types of lead acid batteries: Sealed, Gel, Flooded and User defined.
- Battery temperature compensation function
- Multiple load control modes
- Extensive electronic safety protection features
- Parameter monitoring and adjustment via multiple connection methods
- Use of standard Modbus communication protocol for RS485 bus connections
- RS485 connector can provide a power supply
- Aluminum housing for improved cooling
- IP67 waterproof rating

3. Product Features

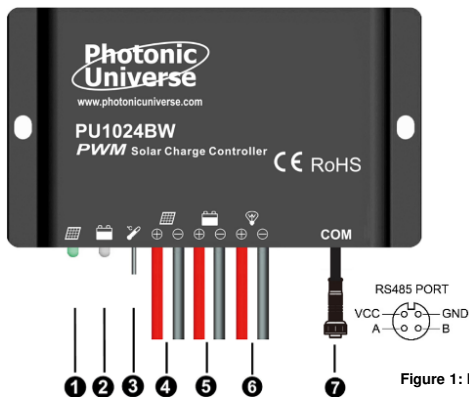

Figure 1: Product features

1 Charging Status LED indicator	5 Battery connection cables
2 Battery Status LED indicator	6 Load connection cables (optional)
3 External Temperature Sensor*	7 RS485 waterproof connector**
4 PV connection cables	

* If the temperature sensor is short-circuited or damaged, the controller will charge or discharge at the internal temperature of device.

**The connector provides 5V voltage and 150mA current. The pin definition is shown in the diagram

4. Wiring

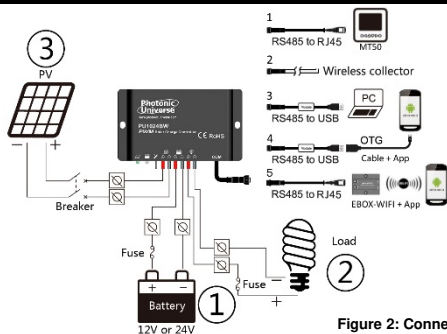



Figure 2: Connection diagram

- 1) Connect components to the charge controller in the sequence as shown above. Pay close attention to the "+" and "-" polarity. Please do not insert the fuse or turn on the breaker during the installation. When disconnecting the system, follow the reverse order.
- 2) After switching on the controller by connecting the battery (step 1 on the diagram), the battery LED indicator on the controller should turn on. If not, please refer to section 8 of this manual.
- 3) The load terminals do not have to be connected if the controller is used for battery charging only. The load terminals are optional; they are designed for small loads in applications which would benefit from low battery cut-off protection and scheduled on/off switching (e.g dusk to dawn programme etc).
- 4) The load terminals **cannot be used for charging a second battery**.
- 5) The battery fuse should be installed on the positive (+) side of the battery, as close to the battery as possible. The fuse must be 1.25 to 2 times the rated current of the controller.



Any inverter or other powerful load must be connected directly to the battery. Do not connect it to the load terminals of the controller.

5. LED Indicators

Indicator	Colour	Status	Description
 (charging LED)	Green	On solid	PV connection normal but PV voltage low, no charging
	Green	OFF	No PV voltage (night time), PV disconnected or PV connection error
	Green	Slow flashing (1 x per second)	Charging
	Green	Fast Flashing (4 x per second)	PV reverse polarity
 (battery LED)	Green	On solid	Normal
	Green	Slow flashing (1 x per second)	Full
	Green	Fast Flashing (4 x per second)	Over voltage
	Orange	On solid	Under voltage
	Red	On solid	Over discharged
	Red	Slow flashing (1 x per second)	Battery overheating
Charging (green) and battery indicator (orange) flashing simultaneously			Controller overheating
Charging (green) and battery indicator (red) flashing simultaneously			System voltage error

6. Settings

The controller is pre-programmed with factory default parameters, such as sealed battery type and light on/off load working mode. If these settings or other parameters need to be changed, the controller must be connected to a remote meter, PC or a mobile device using a special communication cable with a waterproof RS485 socket.

➤ Connection options

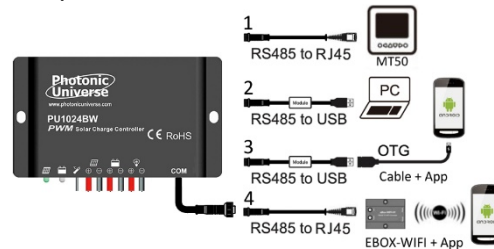

Figure 3: Parameter programming

There are four connection options to view and adjust charging parameters through the controller's RS485 communication port:

- 1) **MT50 remote meter**
 - Requires RS485 to RJ45 connection cable (product code BW2MT50)
- 2) **PC connection (monitoring software "Solar Station Monitor")**
 - Requires RS485 to USB connection cable
- 3) **Smartphone or tablet connection (monitoring app "Solar Station Monitor")**
 - Requires RS485 to USB connection cable and OTG mobile cable
- 4) **Wi-Fi module (EBOX-WIFI) for wireless connectivity to a smartphone or tablet (monitoring app "Solar Station Monitor")**
 - Requires RS485 to RJ45 connection cable (product code BW2MT50)

➤ Load working modes

1) Manual Mode

The load can be switched on via button or remote-control command using one of the communication options above.

2) Light ON/OFF (Default)

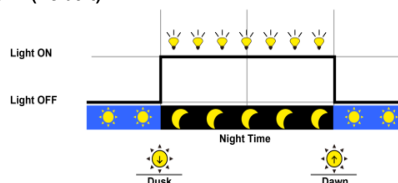

3) Light ON + Timer

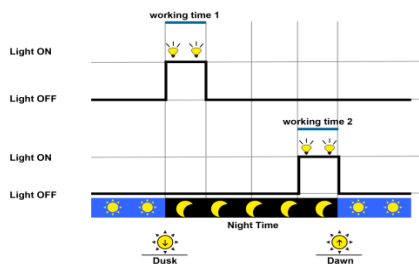

4) Real-time Control

Control the load ON/OFF time through setting a real-time clock.



NOTE: In the Light ON/OFF mode and Light ON/Timer mode, the Load is turned on after a 10 min delay.

> Battery type and other parameters

In addition to the load working mode, the communication methods above allow changing other controller parameters, including:

- Battery type (sealed, gel, flooded and user-defined)
- Charging voltages (for user-defined battery type only) and duration of charging stages
- Load cut off voltage and reconnect voltages
- Other parameters relating to charging or discharging.

7. Protection Features

Function	Details
PV Reverse Polarity	The controller is protected against reverse PV polarity. In case of accidental incorrect PV connection, correct the wiring mistake to resume normal operation.
Battery Reverse Polarity	The controller is protected against reverse polarity of the battery connection. In case of accidental incorrect battery connection, correct the wiring mistake to resume normal operation.
Battery Over-Voltage	When the battery voltage reaches the <i>Over Voltage Disconnect</i> voltage set point, the controller will stop charging the battery to protect the battery from overcharging.
Battery Over-Discharge	When the battery voltage reaches the <i>Low Voltage Disconnect</i> voltage set point, the controller will stop discharging the battery (cut off the load if any load is connected to the load terminals) to protect the battery from deep discharge.
Battery Overheating	The controller uses its external temperature sensor to measure ambient temperature. If the temperature exceeds 65°C, this will automatically trigger the overheating protection. The controller will stop working and resume when the temperature falls below 50°C.
Controller Overheating	If the temperature of the controller exceeds 85°C, the overheating protection will be automatically triggered. The controller will resume normal operations when the temperature falls below 75°C.
Load Short Circuit	The controller is fully protected against load wiring short-circuits. If the load shorts (≥ 4 times rated current), the load short circuit protection will be automatically triggered. After five automatic load reconnect attempts, the fault must be cleared by restarting the controller.
Load Overload	If the load current exceeds the maximum load current rating of the controller by 1.05 times, the controller will disconnect the load. Overloading must be resolved by reducing the load and restarting the controller.
High-Voltage Transients	The controller is protected against small high voltage transients. In lightning-prone areas, additional external suppression is recommended.

8. Troubleshooting

Fault	Possible Reason	Troubleshooting
Charging LED is off during daytime No LED indicators	PV array disconnection Battery voltage may be under 9V	Confirm that PV and battery wire connections are correct and tight. Measure battery voltage with a multi-meter. Min 9V is required for start-up.
Battery LED green, flashing fast (4 x per sec.)	Battery over voltage	Check if battery voltage is higher than over-voltage disconnect point, and disconnect PV.
Battery LED red, constant	Battery over-discharged	Load will recover when battery voltage \geq low-voltage reconnect point.
Battery LED red, flashing	Battery overheating	System will automatically switch off. Operation will resume when temp. < 50 °C.
Charging LED flashing green + Battery LED flashing orange or red	Controller Overheating	Cool down the surrounding area, or decrease the PV or load power.
	System voltage error	Check battery voltage is suitable for controller's operating voltage. If not, change the battery or reset the working voltage.
No load output	Load terminals are switched off	The load terminals should be off at this time in line with the current load working mode. Use RS485 port to change the load working mode (e.g. load terminals permanently on)

No load output	Overload	Reduce the number of electrical appliances connected and check load connections.
	Output short circuit	Restart the controller

9. Technical Specifications

	PU1024BW	PU2024BW
Nominal system voltage	12V /24V DC Auto	
Battery input voltage range	9 – 34V DC	
Max. PV open circuit voltage	50V	
Rated charge current	10A	20A
Rated discharge current	10A	20A
Battery type	Sealed (default) / Gel / Flooded / User	
Self-consumption	12V ≤ 9 mA / 24V ≤ 7 mA	
Charge circuit voltage drop	≤ 0.3 V	
Discharge circuit voltage drop	≤ 0.2 V	
Temperature compensation coefficient	-3mV/°C/2V	
Working environment temperature	-35°C ~ +55°C	
Enclosure	IP67	
Grounding	Common positive	
Overall dimensions	108.5 x 63 x 25.6mm	139 x 75 x 28mm
Mounting dimensions	100.5mm	131mm
Mounting hole size	$\Phi 5$	$\Phi 5$
Power cable	14AWG(2.1mm ²)	14AWG(2.1mm ²)
Net weight	0.26kg	0.47kg

Battery Voltage Control Parameters

(below parameters are for a 12V system at 25 °C, please double the values for 24V)

	Sealed	Gel	Flooded	User
Over Voltage Disconnect Voltage	16.0V	16.0V	16.0V	9~17V
Charging Limit Voltage	15.0V	15.0V	15.0V	9~17V
Over Voltage Reconnect Voltage	15.0V	15.0V	15.0V	9~17V
Equalize Charging Voltage	14.6V	—	14.8V	9~17V
Boost Charging Voltage	14.4V	14.2V	14.6V	9~17V
Float Charging Voltage	13.8V	13.8V	13.8V	9~17V
Boost Reconnect Charging Voltage	13.2V	13.2V	13.2V	9~17V
Low Voltage Reconnect Voltage	12.6V	12.6V	12.6V	9~17V
Under Voltage Warning Reconnect Voltage	12.2V	12.2V	12.2V	9~17V
Under Voltage Warning Voltage	12.0V	12.0V	12.0V	9~17V
Low Voltage Disconnect Voltage	11.1V	11.1V	11.1V	9~17V
Discharging Limit Voltage	10.6V	10.6V	10.6V	9~17V
Equalize Duration	120 min	—	120 min	0~180 min
Boost Duration	120 min	120 min	120 min	10~180 min

NOTE:

1) The default battery type is Sealed. For Sealed, Gel, Flooded battery types, the voltage parameters are fixed and non-modifiable. The range of Equalize Duration is 0 – 180 mins and Boost Duration is 10 – 180 mins.

2) "User" is the user defined battery type. The default value is the same as "Sealed". When modifying, please follow the restrictions below:

- Over Voltage Disconnect Voltage > Charging Limit Voltage \geq Equalize Charging Voltage \geq Boost Charging Voltage \geq Float Charging Voltage > Boost Reconnect Charging Voltage.
- Over Voltage Disconnect Voltage > Over Voltage Reconnect Voltage.
- Low Voltage Reconnect Voltage > Low Voltage Disconnect Voltage \geq Discharging Limit Voltage.
- Under Voltage Warning Reconnect Voltage > Under Voltage Warning Voltage \geq Discharging Limit Voltage.
- Boost Reconnect Charging voltage > Low Voltage Disconnect Voltage.

10. Disclaimer

This product is covered by a 1 year warranty. The warranty is invalid under the following conditions:

- Damage from improper use or use in an unsuitable environment.
- Solar or load current, voltage or power exceeding the rated value of controller.
- The controller working temperature exceeds the max. temperature as per specifications.
- User disassembly or attempted repair of the controller without permission.
- The controller is damaged due to natural elements such as lightning.
- The controller is damaged during transportation and shipment.
- Custom, non-compatible or non-genuine communication accessories are connected to the RS485 port of the controller.

This user manual is subject to changes without prior notice.