

NOTE: ON LEVEL GRADE DIG A 18"/24" HOLE 18" DEEP AT EACH ANCHOR POINT. REPOSITION BASE RAILS OVER HOLES AND DROP A GROUND ANCHOR THROUGH EACH HOLE IN BASE RAILS. FILL EACH HOLE WITH 2500 PSI CONCRETE.

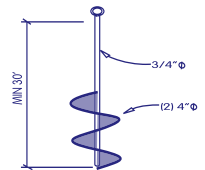

NOTE: 1. HELICAL ANCHORS ARE NOT TO BE USED IF DRIVING TORQUE INTO GROUND IS LESS THAN 150 FT-LBS

# Coast To Coast

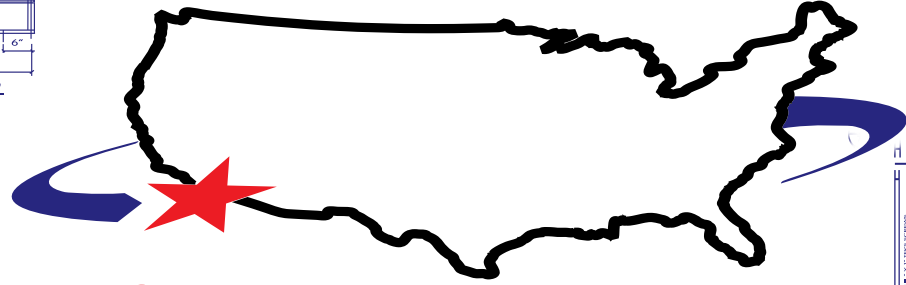

# Carports, Inc.

The Leading Manufacturer of Carports & Steel Buildings

Made in the USA!

## BUILDINGS GARAGES CARPORTS

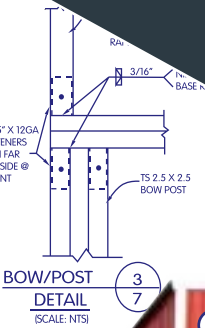
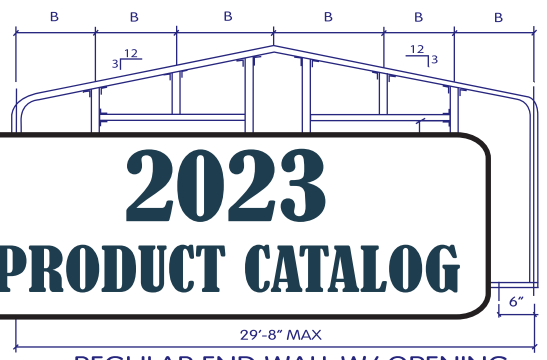
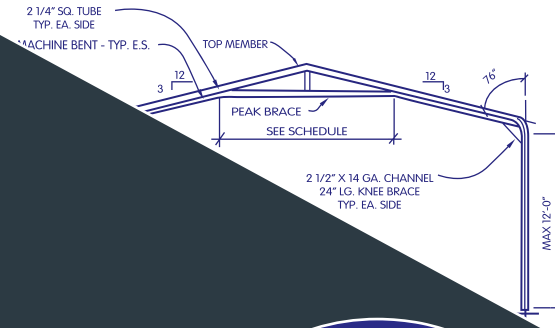

**BOW/POST DETAIL**  
(SCALE: NTS)



[WWW.COAST-TO-COASTCARPORTS.COM](http://WWW.COAST-TO-COASTCARPORTS.COM)



# ABOUT US



## WHY CHOOSE COAST TO COAST CARPORTS, INC.?

Between our quality products, fair price, outstanding customer service, and a passion for helping others: you won't find another steel building company that offers what we do. Coast To Coast Carports, Inc. is one of the largest manufacturers in the metal building industry. It's because of our manufacturing facilities across the country that we're able to deliver our products to our customers throughout most of the United States. While we offer one of the largest selections of steel buildings: you can also opt to design and customize one for yourself. With such a wide variety of customizable options, it's nearly impossible to not get the metal structure of your dreams.

## OUR VISION

Our vision here at Coast To Coast Carports, Inc. is to continue providing our customers with high-quality steel structures and staying ahead of our competition with our honesty and integrity, while turning satisfied customer experiences into lasting relationships.

## COMPANY VALUES

- Taking responsibility for all of our actions, decisions, policies, and products.
- Being committed to providing outstanding products and services.
- Giving back to our community by contributing time and effort.
- Taking chances to further help the company.
- Maintaining honesty and honor in all we do.
- Building long-lasting relationships with our employees, customers, and business partners.



# WHAT WE DO





# CERTIFIED CARPORTS 30 PSF



NOTE: Vertical Buildings Are 1' Shorter Than Horizontal.



## VERTICAL ROOF STYLE

AS LOW AS  
**\$2,095.00**

STANDARD 14 GAUGE, 6" LEGS

Prices are for top with open sides only.

**STANDARD FEATURES**  
5 Bows, Corner Braces, and Center Braces. (Welded center braces standard on 22' wide and wider) and Braces on Legs.

\*Welded peak brace standard

14 GAUGE	12 x 20	\$2,095.00	18 x 20	\$2,495.00	20 x 20	\$2,695.00	*22 x 20	\$2,895.00	*24 x 20	\$3,095.00
	12 x 25	\$2,595.00	18 x 25	\$3,095.00	20 x 25	\$3,295.00	*22 x 25	\$3,495.00	*24 x 25	\$3,695.00
	12 x 30	\$3,695.00	18 x 30	\$3,795.00	20 x 30	\$3,895.00	*22 x 30	\$4,095.00	*24 x 30	\$4,395.00
	12 x 35	\$3,795.00	18 x 35	\$4,095.00	20 x 35	\$4,395.00	*22 x 35	\$4,695.00	*24 x 35	\$5,495.00
	12 x 40	\$3,895.00	18 x 40	\$4,595.00	20 x 40	\$4,995.00	*22 x 40	\$5,595.00	*24 x 40	\$6,195.00
	12 x 45	\$4,195.00	18 x 45	\$4,795.00	20 x 45	\$5,095.00	*22 x 45	\$5,695.00	*24 x 45	\$6,495.00
	12 x 50	\$4,695.00	18 x 50	\$5,195.00	20 x 50	\$5,895.00	*22 x 50	\$6,695.00	*24 x 50	\$7,595.00



Has Horizontal Roof

We Offer 3 Styles

- \*A-Frame Horizontal
- \*A-Frame Vertical Roof Only
- \*A-Frame Vertical Entire Bldg.

## A-FRAME STYLE

AS LOW AS  
**\$1,595.00**

STANDARD 14 GAUGE, 6" LEGS

Prices are for top with open sides only.

**STANDARD FEATURES**  
5 Bows, Corner Braces, and Center Braces. (Welded center braces standard on 22' wide and wider) and Braces on Legs.

\*Welded peak brace standard

14 GAUGE	12 x 21	\$1,595.00	18 x 21	\$1,995.00	20 x 21	\$2,195.00	*22 x 21	\$2,495.00	*24 x 21	\$2,695.00
	12 x 26	\$1,895.00	18 x 26	\$2,395.00	20 x 26	\$2,595.00	*22 x 26	\$2,895.00	*24 x 26	\$3,195.00
	12 x 31	\$2,395.00	18 x 31	\$2,895.00	20 x 31	\$3,295.00	*22 x 31	\$3,395.00	*24 x 31	\$3,595.00
	12 x 36	\$2,795.00	18 x 36	\$3,595.00	20 x 36	\$3,695.00	*22 x 36	\$3,895.00	*24 x 36	\$4,095.00



Prices are for top with open sides only.

## REGULAR STYLE

AS LOW AS  
**\$1,495.00**

STANDARD 14 GAUGE, 6" LEGS

**STANDARD FEATURES**  
5 Bows, Corner Braces, and Center Braces. (Welded center braces standard on 22' wide and wider) and Braces on Legs.

\*Welded peak brace standard

14 GAUGE	12 x 21	\$1,495.00	18 x 21	\$1,895.00	20 x 21	\$1,995.00	*22 x 21	\$2,295.00	*24 x 21	\$2,595.00
	12 x 26	\$1,795.00	18 x 26	\$2,295.00	20 x 26	\$2,495.00	*22 x 26	\$2,795.00	*24 x 26	\$2,995.00
	12 x 31	\$2,195.00	18 x 31	\$2,695.00	20 x 31	\$2,895.00	*22 x 31	\$3,195.00	*24 x 31	\$3,395.00
	12 x 36	\$2,395.00	18 x 36	\$3,095.00	20 x 36	\$3,295.00	*22 x 36	\$3,695.00	*24 x 36	\$3,995.00

### Colonial Style

(Best purchase vertical sides and ends to add Colonial Style Options)



**EXTRA FRAME** 12' - 20' WIDE \$225.00 (each)  
**BOWS** 22' - 24' WIDE \$250.00 (each)  
(Includes standard legs) \* Add \$10.00 for each foot extra height

**FRAME OUTSIDE WALL**  
Up To 12' Garage Side Closed Price, Plus:  
Square (Traditional) 2000' == \$250.00 per opening  
1500' == \$200.00 per opening  
45" Gassing 2000' == \$350.00 per opening  
Window: \$125.00  
Walk-In Door: \$150.00  
12' - 80' \$450.00

12' - 24' GABLE END \$250.00 (each)  
VERTICAL GABLE END \$275.00 (each)

**WELDED CENTER BRACE UPGRADE**  
4" Brace recommended for 12' wide bow \$25.00 per bow  
6" Brace recommended for 18' - 30' wide bow \$40.00 per bow  
\*Welded center braces standard on 22' wide and wider



* EXTRA LABOR	21' Long	26' Long	31' Long	36' Long	41' Long	46' Long	51' Long
	INSTALL OVER EXISTING	\$100.00	\$125.00	\$150.00	\$175.00	\$200.00	\$250.00
	INSTALL ON DECK/DOCK (NON FLOATING)	\$100.00	\$125.00	\$150.00	\$175.00	\$200.00	\$250.00
	INSTALL ON WALL (UP TO 3')	\$100.00	\$125.00	\$150.00	\$175.00	\$200.00	\$250.00
CUT LEGS ON SITE	\$50.00	\$75.00	\$100.00	\$125.00	\$150.00	\$175.00	\$200.00

NOTE: If you are needing special drawings or wet stamped drawings for your building, there will be an additional charge.

\*Rent to Own Available Only In Participating States, and Participating Dealerships



# OPTION LIST

**NOTE: Vertical Roof Option available on A-FRAME Style Carports only**

		21' Long	26' Long	31' Long	36' Long	41' Long	46' Long	51' Long	
<b>CERTIFIED WIND 140 MPH</b>		\$200.00	\$250.00	\$250.00	\$300.00	\$350.00	\$400.00	\$400.00	
<b>DOUBLE LEG UP TO 12'</b>		\$850.00	\$1,100.00	\$1,300.00	\$1,500.00	\$1,750.00	\$2000.00	\$2,250.00	
<b>J-TRIM</b>		\$60.00	\$70.00	\$80.00	\$90.00	\$100.00	\$110.00	\$120.00	
<b>LEG HEIGHT</b>		21' Long	26' Long	31' Long	36' Long	41' Long	46' Long	51' Long	
<b>HEIGHT</b>	<b>DOUBLE LEGS</b>	6 Ft	STD	STD	STD	STD	STD	STD	
		7 Ft	\$80.00	\$100.00	\$120.00	\$140.00	\$160.00	\$180.00	\$200.00
		8 Ft	\$160.00	\$200.00	\$240.00	\$280.00	\$320.00	\$360.00	\$400.00
		9 Ft	\$240.00	\$300.00	\$360.00	\$420.00	\$480.00	\$540.00	\$600.00
		10 Ft	\$320.00	\$400.00	\$480.00	\$560.00	\$640.00	\$720.00	\$800.00
		11 Ft	\$400.00	\$500.00	\$600.00	\$700.00	\$800.00	\$900.00	\$1,000.00
	<b>LADDER LEGS</b>	12 Ft	\$480.00	\$600.00	\$720.00	\$840.00	\$960.00	\$1,080.00	\$1,200.00
		13 Ft	\$1,600.00	\$2,000.00	\$2,300.00	\$2,700.00	\$3,100.00	\$3,400.00	\$3,825.00
		14 Ft	\$1,650.00	\$2,100.00	\$2,420.00	\$2,880.00	\$3,290.00	\$3,600.00	\$4,010.00
		15 Ft	\$1,920.00	\$2,480.00	\$2,640.00	\$3,130.00	\$3,610.00	\$4,090.00	\$4,570.00
	16 Ft	\$2,160.00	\$2,520.00	\$2,880.00	\$3,360.00	\$3,850.00	\$4,330.00	\$4,810.00	
	17 Ft	\$2,710.00	\$3,070.00	\$3,430.00	\$4,160.00	\$4,600.00	\$5,035.00	\$5,475.00	
	18 Ft	\$2,820.00	\$3,200.00	\$3,590.00	\$4,350.00	\$4,815.00	\$5,280.00	\$5,750.00	
	19 Ft	\$2,940.00	\$3,340.00	\$3,750.00	\$4,550.00	\$5,040.00	\$5,540.00	\$6,040.00	
	20 Ft	\$3,060.00	\$3,475.00	\$3,900.00	\$4,750.00	\$5,275.00	\$5,805.00	\$6,330.00	

**& Lift Required, Includes Certification (If Installed On Concrete).**

Colonial Style	\$240.00	\$300.00	\$360.00	\$420.00	\$480.00	\$552.00	\$600.00		
LEG HEIGHT	21' Long	26' Long	31' Long	36' Long	41' Long	46' Long	51' Long		
<b>BOTH SIDES CLOSED</b>	6 Ft	\$560.00	\$630.00	\$750.00	\$810.00	\$1,060.00	\$1,185.00	\$1,310.00	
	7 Ft	\$655.00	\$735.00	\$875.00	\$945.00	\$1,310.00	\$1,390.00	\$1,530.00	
	8 Ft	\$760.00	\$880.00	\$1,000.00	\$1,080.00	\$1,440.00	\$1,605.00	\$1,760.00	
	9 Ft	\$800.00	\$975.00	\$1,125.00	\$1,215.00	\$1,500.00	\$1,675.00	\$1,850.00	
	10 Ft	\$950.00	\$1,100.00	\$1,250.00	\$1,350.00	\$1,830.00	\$2,035.00	\$2,200.00	
	11 Ft	\$1,045.00	\$1,210.00	\$1,375.00	\$1,485.00	\$1,925.00	\$2,145.00	\$2,365.00	
	12 Ft	\$1,075.00	\$1,310.00	\$1,500.00	\$1,620.00	\$2,015.00	\$2,250.00	\$2,485.00	
	13 Ft	\$1,225.00	\$1,430.00	\$1,625.00	\$1,755.00	\$2,345.00	\$2,610.00	\$2,860.00	
	14 Ft	\$1,305.00	\$1,540.00	\$1,750.00	\$1,890.00	\$2,410.00	\$2,690.00	\$2,970.00	
	<b>VERTICAL SIDES INCLUDED</b>	15 Ft	\$2,155.00	\$2,695.00	\$3,240.00	\$3,740.00	\$4,315.00	\$4,890.00	\$5,470.00
		16 Ft	\$2,430.00	\$3,020.00	\$3,645.00	\$4,255.00	\$4,855.00	\$5,460.00	\$6,070.00
		17 Ft	\$2,690.00	\$3,355.00	\$4,030.00	\$4,665.00	\$5,335.00	\$6,000.00	\$6,680.00
		18 Ft	\$2,940.00	\$3,680.00	\$4,405.00	\$5,155.00	\$5,875.00	\$6,595.00	\$7,310.00
		19 Ft	\$3,220.00	\$4,015.00	\$4,810.00	\$5,610.00	\$6,415.00	\$7,215.00	\$8,040.00
20 Ft		\$3,470.00	\$4,315.00	\$5,200.00	\$6,045.00	\$6,910.00	\$7,770.00	\$8,640.00	
Vertical Sides Option Add.	6 ft-10 ft \$325.00 11 ft-14 ft \$450.00	6 ft-10 ft \$375.00 11 ft-14 ft \$525.00	6 ft-10 ft \$425.00 11 ft-14 ft \$600.00	6 ft-10 ft \$475.00 11 ft-14 ft \$675.00	6 ft-10 ft \$525.00 11 ft-14 ft \$750.00	6 ft-10 ft \$600.00 11 ft-14 ft \$850.00	6 ft-10 ft \$650.00 11 ft-14 ft \$925.00		

Colonial Style	\$144.00	\$216.00	\$240.00	\$264.00	\$288.00		
LEG HEIGHT	12' Wide	18' Wide	20' Wide	22' Wide	24' Wide		
<b>CLOSED END (Per End)</b>	6 Ft	\$525.00	\$675.00	\$845.00	\$925.00	\$1,005.00	
	7 Ft	\$670.00	\$815.00	\$945.00	\$1,050.00	\$1,140.00	
	8 Ft	\$685.00	\$985.00	\$1,045.00	\$1,150.00	\$1,240.00	
	9 Ft	\$700.00	\$1,000.00	\$1,100.00	\$1,200.00	\$1,300.00	
	10 Ft	\$755.00	\$1,115.00	\$1,235.00	\$1,350.00	\$1,440.00	
	11 Ft	\$790.00	\$1,150.00	\$1,270.00	\$1,390.00	\$1,510.00	
	12 Ft	\$825.00	\$1,185.00	\$1,305.00	\$1,425.00	\$1,545.00	
	13 Ft	\$900.00	\$1,350.00	\$1,500.00	\$1,650.00	\$1,800.00	
	14 Ft	\$950.00	\$1,400.00	\$1,550.00	\$1,700.00	\$1,850.00	
	<b>VERTICAL ENDS INCLUDED</b>	15 Ft	\$1,675.00	\$2,110.00	\$2,540.00	\$2,970.00	\$3,360.00
		16 Ft	\$1,820.00	\$2,280.00	\$2,870.00	\$3,210.00	\$3,590.00
		17 Ft	\$1,970.00	\$2,470.00	\$2,980.00	\$3,470.00	\$3,950.00
		18 Ft	\$2,110.00	\$2,640.00	\$3,200.00	\$3,720.00	\$4,230.00
		19 Ft	\$2,300.00	\$2,830.00	\$3,410.00	\$3,960.00	\$4,520.00
20 Ft		\$2,450.00	\$3,050.00	\$3,620.00	\$4,220.00	\$4,800.00	
Vertical Ends Option Add.	6 ft-10 ft \$350.00 11 ft-14 ft \$450.00	6 ft-10 ft \$550.00 11 ft-14 ft \$650.00	6 ft-10 ft \$600.00 11 ft-14 ft \$700.00	6 ft-10 ft \$650.00 11 ft-14 ft \$750.00	6 ft-10 ft \$700.00 11 ft-14 ft \$800.00		

## DOUBLE LEG OPTION

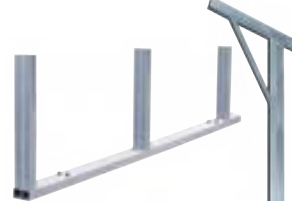

## NOTES

- \* Prices may vary by area.
- \* Prices are subject to change without notice.
- \* To create a building length greater than 51', two or more buildings may be attached for \$120.00 per attachment.
- \* To price a customized building with the width or length in between the sizes shown, then use the next size up.



**\*NOTE: Customer must provide lift on 13' or taller buildings.**

NOTE: If you are needing special drawings or wet stamped drawings for your building, there will be an additional charge.

\* Rent to Own Available Only In Participating States, and Participating Dealerships



# CERTIFIED TRIPLE WIDE CARPORTS 35 Lbs PSF/140 MPH



### STANDARD FEATURES

14 Gauge Galvanized Framing, 29 Gauge Metal Roofing (Siding Optional), Welded Trussing System, Legs 5' on Centers or Less, 2" Braces on Legs & Either Concrete, Or Rebar & Mobile Home Anchors Included.



## VERTICAL ROOF STYLE

AS LOW AS  
**\$3,695.00**

STANDARD 14 GAUGE, 6" LEGS  
26 x 20 x 6

Prices are for top with open sides only.

**NOTE: Vertical Buildings Are 1' Shorter Than Horizontal.**

14 GAUGE	26 x 20	\$3,695.00	28 x 20	\$3,895.00	30 x 20	\$3,995.00
	26 x 25	\$4,195.00	28 x 25	\$4,595.00	30 x 25	\$4,795.00
	26 x 30	\$5,595.00	28 x 30	\$5,795.00	30 x 30	\$6,095.00
	26 x 35	\$6,195.00	28 x 35	\$6,595.00	30 x 35	\$6,895.00
	26 x 40	\$7,195.00	28 x 40	\$7,395.00	30 x 40	\$7,695.00
	26 x 45	\$7,295.00	28 x 45	\$7,995.00	30 x 45	\$8,595.00
	26 x 50	\$7,995.00	28 x 50	\$8,595.00	30 x 50	\$9,395.00



Has Horizontal Roof

### STANDARD FEATURES

14 Gauge Galvanized Framing, 29 Gauge Metal Roofing (Siding Optional), Welded Trussing System, Legs 5' on Centers or Less, 2" Braces on Legs & Either Concrete, Or Rebar & Mobile Home Anchors Included.

## A-FRAME STYLE

AS LOW AS  
**\$2,895.00**

STANDARD 14 GAUGE, 6" LEGS  
26 x 21 x 6

Prices are for top with open sides only.

We Offer 3 Styles

- \*A-Frame Horizontal
- \*A-Frame Vertical Roof Only
- \*A-Frame Vertical Entire Bldg.

14 GAUGE	26 x 21	\$2,895.00	28 x 21	\$2,995.00	30 x 21	\$3,195.00
	26 x 26	\$3,595.00	28 x 26	\$3,695.00	30 x 26	\$3,995.00
	26 x 31	\$4,195.00	28 x 31	\$4,395.00	30 x 31	\$4,595.00
	26 x 36	\$4,795.00	28 x 36	\$5,195.00	30 x 36	\$5,995.00



### STANDARD FEATURES

14 Gauge Galvanized Framing, 29 Gauge Metal Roofing (Siding Optional), Welded Trussing System, Legs 5' on Centers or Less, 2" Braces on Legs & Either Concrete, Or Rebar & Mobile Home Anchors Included.

## REGULAR STYLE

AS LOW AS  
**\$2,795.00**

STANDARD 14 GAUGE, 6" LEGS  
26 x 21 x 6

Prices are for top with open sides only.

14 GAUGE	26 x 21	\$2,795.00	28 x 21	\$2,895.00	30 x 21	\$3,095.00
	26 x 26	\$3,395.00	28 x 26	\$3,595.00	30 x 26	\$3,795.00
	26 x 31	\$3,995.00	28 x 31	\$4,195.00	30 x 31	\$4,395.00
	26 x 36	\$4,595.00	28 x 36	\$4,895.00	30 x 36	\$5,395.00

* EXTRA LABOR	21' Long	26' Long	31' Long	36' Long	41' Long	46' Long	51' Long
INSTALL OVER EXISTING	\$200.00	\$250.00	\$300.00	\$350.00	\$400.00	\$450.00	\$500.00
INSTALL ON DECK/DOCK (NON FLOATING)	\$200.00	\$250.00	\$300.00	\$350.00	\$400.00	\$450.00	\$500.00
INSTALL ON WALL (UP TO 3')	\$200.00	\$250.00	\$300.00	\$350.00	\$400.00	\$450.00	\$500.00
CUT LEGS ON SITE	\$100.00	\$150.00	\$200.00	\$250.00	\$300.00	\$350.00	\$400.00



NOTE: If you are needing special drawings or wet stamped drawings for your building, there will be an additional charge.

\*Rent to Own Available Only In Participating States, and Participating Dealerships.



# OPTION LIST

	21' Long	26' Long	31' Long	36' Long	41' Long	46' Long	51' Long
<b>J-TRIM</b>	\$60.00	\$70.00	\$80.00	\$90.00	\$100.00	\$110.00	\$120.00
<b>DOUBLE LEG UP TO 12'</b>	\$850.00	\$1,100.00	\$1,300.00	\$1,500.00	\$1,750.00	\$2,000.00	\$2,250.00

LEG HEIGHT		21' Long	26' Long	31' Long	36' Long	41' Long	46' Long	51' Long	
HEIGHT	6 Ft	STD	STD	STD	STD	STD	STD	STD	
	7 Ft	\$80.00	\$100.00	\$120.00	\$140.00	\$160.00	\$180.00	\$200.00	
	8 Ft	\$160.00	\$200.00	\$240.00	\$280.00	\$320.00	\$360.00	\$400.00	
	9 Ft	\$240.00	\$300.00	\$360.00	\$420.00	\$480.00	\$540.00	\$600.00	
	10 Ft	\$320.00	\$400.00	\$480.00	\$560.00	\$640.00	\$720.00	\$800.00	
	11 Ft	\$400.00	\$500.00	\$600.00	\$700.00	\$800.00	\$900.00	\$1,000.00	
	12 Ft	\$480.00	\$600.00	\$720.00	\$840.00	\$960.00	\$1,080.00	\$1,200.00	
	DOUBLE LEGS	13 Ft	\$1,600.00	\$2,000.00	\$2,300.00	\$2,700.00	\$3,100.00	\$3,400.00	\$3,825.00
		14 Ft	\$1,650.00	\$2,100.00	\$2,420.00	\$2,880.00	\$3,290.00	\$3,600.00	\$4,010.00
		15 Ft	\$1,920.00	\$2,480.00	\$2,640.00	\$3,130.00	\$3,610.00	\$4,090.00	\$4,570.00
16 Ft		\$2,160.00	\$2,520.00	\$2,880.00	\$3,360.00	\$3,850.00	\$4,330.00	\$4,810.00	
LADDER LEGS		17 Ft	\$2,710.00	\$3,070.00	\$3,430.00	\$4,160.00	\$4,600.00	\$5,035.00	\$5,475.00
		18 Ft	\$2,820.00	\$3,200.00	\$3,590.00	\$4,350.00	\$4,815.00	\$5,280.00	\$5,750.00
		19 Ft	\$2,940.00	\$3,340.00	\$3,750.00	\$4,550.00	\$5,040.00	\$5,540.00	\$6,040.00
		20 Ft	\$3,060.00	\$3,475.00	\$3,900.00	\$4,750.00	\$5,275.00	\$5,805.00	\$6,330.00

&  Lift Required

Colonial Style	\$300.00		\$350.00		\$400.00		\$450.00		\$500.00		\$550.00		\$600.00	
LEG HEIGHT	21' Long		26' Long		31' Long		36' Long		41' Long		46' Long		51' Long	
BOTH SIDES CLOSED	6 Ft	\$560.00	\$630.00	\$750.00	\$810.00	\$1,060.00	\$1,185.00	\$1,310.00	\$1,440.00	\$1,600.00	\$1,765.00	\$1,930.00	\$2,100.00	\$2,270.00
	7 Ft	\$655.00	\$735.00	\$875.00	\$945.00	\$1,210.00	\$1,340.00	\$1,510.00	\$1,680.00	\$1,850.00	\$2,025.00	\$2,200.00	\$2,375.00	\$2,550.00
	8 Ft	\$760.00	\$880.00	\$1,000.00	\$1,080.00	\$1,350.00	\$1,480.00	\$1,650.00	\$1,820.00	\$2,000.00	\$2,175.00	\$2,350.00	\$2,525.00	\$2,700.00
	9 Ft	\$800.00	\$975.00	\$1,125.00	\$1,215.00	\$1,500.00	\$1,635.00	\$1,810.00	\$1,990.00	\$2,170.00	\$2,350.00	\$2,530.00	\$2,710.00	\$2,890.00
	10 Ft	\$950.00	\$1,100.00	\$1,250.00	\$1,350.00	\$1,650.00	\$1,795.00	\$2,090.00	\$2,235.00	\$2,530.00	\$2,675.00	\$2,970.00	\$3,115.00	\$3,410.00
	11 Ft	\$1,045.00	\$1,210.00	\$1,375.00	\$1,485.00	\$1,800.00	\$1,950.00	\$2,250.00	\$2,400.00	\$2,700.00	\$2,850.00	\$3,150.00	\$3,300.00	\$3,600.00
	12 Ft	\$1,075.00	\$1,310.00	\$1,500.00	\$1,620.00	\$1,950.00	\$2,075.00	\$2,400.00	\$2,525.00	\$2,850.00	\$2,975.00	\$3,300.00	\$3,425.00	\$3,750.00
	13 Ft	\$1,225.00	\$1,430.00	\$1,625.00	\$1,755.00	\$2,100.00	\$2,230.00	\$2,550.00	\$2,680.00	\$3,000.00	\$3,130.00	\$3,450.00	\$3,580.00	\$3,900.00
	14 Ft	\$1,305.00	\$1,540.00	\$1,750.00	\$1,890.00	\$2,250.00	\$2,390.00	\$2,750.00	\$2,890.00	\$3,250.00	\$3,390.00	\$3,750.00	\$3,890.00	\$4,250.00
	15 Ft	\$2,155.00	\$2,695.00	\$3,240.00	\$3,740.00	\$4,315.00	\$4,815.00	\$5,390.00	\$5,890.00	\$6,465.00	\$6,965.00	\$7,540.00	\$8,040.00	\$8,615.00
VERTICAL SIDES INCLUDED	16 Ft	\$2,430.00	\$3,020.00	\$3,645.00	\$4,255.00	\$4,855.00	\$5,460.00	\$6,070.00	\$6,675.00	\$7,285.00	\$7,890.00	\$8,500.00	\$9,110.00	\$9,720.00
	17 Ft	\$2,690.00	\$3,355.00	\$4,030.00	\$4,665.00	\$5,335.00	\$6,000.00	\$6,680.00	\$7,350.00	\$8,025.00	\$8,700.00	\$9,375.00	\$10,050.00	\$10,725.00
	18 Ft	\$2,940.00	\$3,680.00	\$4,405.00	\$5,155.00	\$5,875.00	\$6,595.00	\$7,315.00	\$8,035.00	\$8,755.00	\$9,475.00	\$10,195.00	\$10,915.00	\$11,635.00
	19 Ft	\$3,220.00	\$4,015.00	\$4,810.00	\$5,610.00	\$6,415.00	\$7,215.00	\$8,015.00	\$8,815.00	\$9,615.00	\$10,415.00	\$11,215.00	\$12,015.00	\$12,815.00
	20 Ft	\$3,470.00	\$4,315.00	\$5,200.00	\$6,045.00	\$6,910.00	\$7,770.00	\$8,630.00	\$9,490.00	\$10,350.00	\$11,210.00	\$12,070.00	\$12,930.00	\$13,790.00
	Vertical Sides Option Add.	6 ft - 10 ft \$400.00	11 ft - 14 ft \$500.00	6 ft - 10 ft \$450.00	11 ft - 14 ft \$600.00	6 ft - 10 ft \$475.00	11 ft - 14 ft \$700.00	6 ft - 10 ft \$525.00	11 ft - 14 ft \$800.00	6 ft - 10 ft \$550.00	11 ft - 14 ft \$900.00	6 ft - 10 ft \$625.00	11 ft - 14 ft \$1,000.00	6 ft - 10 ft \$700.00

Colonial Style	\$350.00		\$400.00		\$450.00	
LEG HEIGHT	26' Wide		28' Wide		30' Wide	
CLOSED END (Per End)	6 Ft	\$1,200.00	\$1,275.00	\$1,350.00	\$1,425.00	\$1,500.00
	7 Ft	\$1,325.00	\$1,475.00	\$1,625.00	\$1,775.00	\$1,925.00
	8 Ft	\$1,375.00	\$1,525.00	\$1,675.00	\$1,825.00	\$1,975.00
	9 Ft	\$1,425.00	\$1,575.00	\$1,725.00	\$1,875.00	\$1,975.00
	10 Ft	\$1,600.00	\$1,800.00	\$1,950.00	\$2,100.00	\$2,200.00
	11 Ft	\$1,625.00	\$1,840.00	\$2,030.00	\$2,220.00	\$2,320.00
	12 Ft	\$1,650.00	\$1,875.00	\$2,100.00	\$2,290.00	\$2,390.00
	13 Ft	\$1,850.00	\$2,025.00	\$2,200.00	\$2,390.00	\$2,490.00
	14 Ft	\$1,900.00	\$2,075.00	\$2,250.00	\$2,440.00	\$2,540.00
	15 Ft	\$3,450.00	\$3,610.00	\$3,760.00	\$3,910.00	\$4,060.00
VERTICAL ENDS INCLUDED	16 Ft	\$3,655.00	\$3,740.00	\$3,890.00	\$4,035.00	\$4,180.00
	17 Ft	\$4,960.00	\$5,170.00	\$5,380.00	\$5,590.00	\$5,800.00
	18 Ft	\$5,650.00	\$5,885.00	\$6,115.00	\$6,345.00	\$6,575.00
	19 Ft	\$6,330.00	\$6,610.00	\$6,890.00	\$7,170.00	\$7,450.00
	20 Ft	\$6,985.00	\$7,290.00	\$7,590.00	\$7,890.00	\$8,190.00
	Vertical Ends Option Add.	6 ft - 10 ft \$800.00	11 ft - 14 ft \$900.00	6 ft - 10 ft \$900.00	11 ft - 14 ft \$1,050.00	6 ft - 10 ft \$1,000.00

**NOTE:** Coast to Coast Carports is not responsible for impenetrable rocky ground.

**EXTRA FRAME BOWS (Includes standard legs)**

26' WIDE	\$275.00	Each
28' WIDE	\$300.00	Each
30' WIDE	\$350.00	Each

\* Add. \$10.00 for each foot extra height

	<b>VERTICAL GABLE END</b>	
26' WIDE	\$300.00	Each \$350.00
28' WIDE	\$350.00	Each \$375.00
30' WIDE	\$375.00	Each \$425.00



**\*NOTE: Customer must provide lift on 13' or taller buildings.**

- Prices may vary by area.
- Prices are subject to change without notice
- To create a building length greater than 51', two or more buildings may be attached for \$120.00 per attachment.

NOTE: If you are needing special drawings or wet stamped drawings for your building, there will be an additional charge.

**\* Rent to Own Available Only In Participating States, and Participating Dealerships**



# CERTIFIED A-FRAME BARN 30 PSF



## STANDARD FEATURES

A-Frame Barn features include the following: 14 gauge galvanized steel framing spaced at 5' on center or less and 29 gauge metal roofing. A Frame Barn package include leg bracing for additional strength and stability, as well as both front and back gable ends on the main section and both lean-tos of the barn. The base leg heights are 12' & 8' tall. Coast to Coast Carports, Inc. is not responsible for stopping, or repairing leaks under base rails.

### CERTIFIED WIND 140 MPH ADD.

21' Long	26' Long	31' Long	36' Long	40' Long
<b>\$400.00</b>	<b>\$500.00</b>	<b>\$500.00</b>	<b>\$600.00</b>	<b>\$700.00</b>

21' Long	26' Long	31' Long	36' Long	40' Long	
14 ga 36 X 21 X 12 <b>\$6,190.00</b> With Vertical Roof \$6,990.00	14 ga 36 X 26 X 12 <b>\$7,200.00</b> With Vertical Roof \$8,400.00	14 ga 36 X 31 X 12 <b>\$8,310.00</b> With Vertical Roof \$10,410.00	14 ga 36 X 36 X 12 <b>\$9,420.00</b> With Vertical Roof \$11,920.00	14 ga 36 X 40 X 12 <b>\$12,912.00</b> Price Includes Vertical Roof	
14 ga 42 X 21 X 12 <b>\$6,590.00</b> With Vertical Roof \$7,490.00	14 ga 42 X 26 X 12 <b>\$7,700.00</b> With Vertical Roof \$8,900.00	14 ga 42 X 31 X 12 <b>\$8,810.00</b> With Vertical Roof \$10,510.00	14 ga 42 X 36 X 12 <b>\$10,220.00</b> With Vertical Roof \$12,220.00	14 ga 42 X 40 X 12 <b>\$13,610.00</b> Price Includes Vertical Roof	
14 ga 44 X 21 X 12 <b>\$6,790.00</b> With Vertical Roof \$7,690.00	14 ga 44 X 26 X 12 <b>\$7,900.00</b> With Vertical Roof \$9,100.00	14 ga 44 X 31 X 12 <b>\$9,210.00</b> With Vertical Roof \$10,610.00	14 ga 44 X 36 X 12 <b>\$10,320.00</b> With Vertical Roof \$12,520.00	14 ga 44 X 40 X 12 <b>\$14,010.00</b> Price Includes Vertical Roof	
14 ga 46 X 21 X 12 <b>\$7,090.00</b> With Vertical Roof \$7,890.00	14 ga 46 X 26 X 12 <b>\$8,200.00</b> With Vertical Roof \$9,300.00	14 ga 46 X 31 X 12 <b>\$9,310.00</b> With Vertical Roof \$10,810.00	14 ga 46 X 36 X 12 <b>\$10,520.00</b> With Vertical Roof \$12,820.00	14 ga 46 X 40 X 12 <b>\$14,610.00</b> Price Includes Vertical Roof	
14 ga 48 X 21 X 12 <b>\$7,290.00</b> With Vertical Roof \$8,090.00	14 ga 48 X 26 X 12 <b>\$8,500.00</b> With Vertical Roof \$9,500.00	14 ga 48 X 31 X 12 <b>\$9,510.00</b> With Vertical Roof \$11,110.00	14 ga 48 X 36 X 12 <b>\$10,720.00</b> With Vertical Roof \$13,920.00	14 ga 48 X 40 X 12 <b>\$15,210.00</b> Price Includes Vertical Roof	

21' Long	26' Long	31' Long	36' Long	40' Long	
14 ga 50 X 21 X 12 <b>\$7,590.00</b> With Vertical Roof \$8,790.00	14 ga 50 X 26 X 12 <b>\$9,000.00</b> With Vertical Roof \$10,100.00	14 ga 50 X 31 X 12 <b>\$10,210.00</b> With Vertical Roof \$12,410.00	14 ga 50 X 36 X 12 <b>\$11,520.00</b> With Vertical Roof \$14,620.00	14 ga 50 X 40 X 12 <b>\$16,310.00</b> Price Includes Vertical Roof	
14 ga 54 X 21 X 12 <b>\$8,040.00</b> With Vertical Roof \$9,240.00	14 ga 54 X 26 X 12 <b>\$9,550.00</b> With Vertical Roof \$10,850.00	14 ga 54 X 31 X 12 <b>\$10,760.00</b> With Vertical Roof \$13,060.00	14 ga 54 X 36 X 12 <b>\$12,870.00</b> With Vertical Roof \$15,470.00	14 ga 54 X 40 X 12 <b>\$16,960.00</b> Price Includes Vertical Roof	

### 35 PSF/140 MPH

Prices may vary from State to State

Prices are subject to change without notice

NOTE: If you are needing special drawings or wet stamped drawings for your building, there will be an additional charge.

\*Rent to Own Available Only In Participating States, and Participating Dealerships

# A-FRAME BARN OPTIONS

LEG HEIGHT	21' Long	26' Long	31' Long	36' Long	41' Long	
<b>HEIGHT</b>	12 / 8 Ft	STD	STD	STD	STD	
	13 / 9 Ft	\$1,200.00	\$1,500.00	\$1,700.00	\$2,000.00	\$2,300.00
	14 / 10 Ft	\$1,330.00	\$1,700.00	\$1,940.00	\$2,320.00	\$2,650.00
	15 / 11 Ft	\$1,680.00	\$2,180.00	\$2,280.00	\$2,710.00	\$3,130.00
	16 / 12 Ft	\$2,000.00	\$2,320.00	\$2,640.00	\$3,080.00	\$3,530.00
	17 / 13 Ft	\$3,670.00	\$4,270.00	\$4,770.00	\$5,740.00	\$6,420.00
	18 / 14 Ft	\$3,830.00	\$4,500.00	\$5,050.00	\$6,110.00	\$6,825.00
	19 / 15 Ft	\$4,220.00	\$5,020.00	\$5,430.00	\$6,560.00	\$7,370.00
20 / 16 Ft	\$4,580.00	\$5,195.00	\$5,820.00	\$6,990.00	\$7,845.00	

Colonial Style	\$240.00		\$300.00		\$360.00		\$420.00		\$480.00	
LEG HEIGHT	21' Long		26' Long		31' Long		36' Long		41' Long	
<b>BOTH SIDES CLOSED</b>	<b>BOTH SIDES INCLUDED</b>	8 Ft	\$760.00	\$880.00	\$1,000.00	\$1,080.00	\$1,440.00	\$1,500.00	\$1,830.00	\$1,925.00
		9 Ft	\$800.00	\$975.00	\$1,125.00	\$1,215.00	\$1,500.00	\$1,620.00	\$2,015.00	\$2,345.00
		10 Ft	\$950.00	\$1,100.00	\$1,250.00	\$1,350.00	\$1,750.00	\$1,890.00	\$2,410.00	\$2,690.00
		11 Ft	\$1,045.00	\$1,210.00	\$1,375.00	\$1,485.00	\$2,155.00	\$2,345.00	\$3,15.00	\$3,35.00
		12 Ft	\$1,075.00	\$1,310.00	\$1,500.00	\$1,620.00	\$2,405.00	\$2,610.00	\$3,415.00	\$3,680.00
		13 Ft	\$1,225.00	\$1,430.00	\$1,625.00	\$1,755.00	\$2,510.00	\$2,745.00	\$3,535.00	\$3,875.00
	<b>VERTICAL SIDES INCLUDED</b>	14 Ft	\$1,305.00	\$1,540.00	\$1,750.00	\$1,890.00	\$2,645.00	\$2,855.00	\$3,615.00	\$3,915.00
		15 Ft	\$2,155.00	\$2,695.00	\$3,240.00	\$3,740.00	\$4,370.00	\$4,665.00	\$5,335.00	\$5,875.00
		16 Ft	\$2,430.00	\$3,020.00	\$3,645.00	\$4,255.00	\$4,910.00	\$5,155.00	\$5,875.00	\$6,415.00
		17 Ft	\$2,690.00	\$3,355.00	\$4,030.00	\$4,665.00	\$5,335.00	\$5,610.00	\$6,415.00	\$6,910.00
		18 Ft	\$2,940.00	\$3,680.00	\$4,405.00	\$5,155.00	\$5,875.00	\$6,415.00	\$6,910.00	\$7,370.00
		19 Ft	\$3,220.00	\$4,015.00	\$4,810.00	\$5,610.00	\$6,415.00	\$6,910.00	\$7,370.00	\$7,845.00
20 Ft	\$3,470.00	\$4,315.00	\$5,200.00	\$6,045.00	\$6,910.00	\$7,370.00	\$7,845.00	\$8,300.00	\$8,760.00	
Vertical Sides Option Add.	8 ft - 10 ft \$325.00	11 ft - 14 ft \$450.00	8 ft - 10 ft \$375.00	11 ft - 14 ft \$525.00	8 ft - 10 ft \$425.00	11 ft - 14 ft \$600.00	8 ft - 10 ft \$475.00	11 ft - 14 ft \$675.00	8 ft - 10 ft \$525.00	11 ft - 14 ft \$750.00

Colonial Style	\$432.00	\$504.00	\$528.00	\$552.00	\$576.00	\$638.00	\$738.00		
LEG HEIGHT	36' Wide	42' Wide	44' Wide	46' Wide	48' Wide	50' Wide	54' Wide		
<b>CLOSED END (Per End)</b>	<b>BOTH SIDES INCLUDED</b>	12 / 8 Ft	\$1,565.00	\$1,925.00	\$2,045.00	\$2,165.00	\$2,285.00	\$2,340.00	\$2,715.00
		13 / 9 Ft	\$1,700.00	\$2,150.00	\$2,300.00	\$2,450.00	\$2,600.00	\$2,675.00	\$2,875.00
		14 / 10 Ft	\$1,890.00	\$2,340.00	\$2,490.00	\$2,640.00	\$2,790.00	\$2,855.00	\$3,065.00
		15 / 11 Ft	\$2,685.00	\$3,120.00	\$3,550.00	\$3,980.00	\$4,370.00	\$4,410.00	\$4,645.00
	<b>VERTICAL SIDES INCLUDED</b>	16 / 12 Ft	\$2,865.00	\$3,325.00	\$3,915.00	\$4,255.00	\$4,635.00	\$4,650.00	\$4,810.00
		17 / 13 Ft	\$3,270.00	\$3,770.00	\$4,280.00	\$4,770.00	\$5,250.00	\$6,210.00	\$6,555.00
		18 / 14 Ft	\$3,460.00	\$3,990.00	\$4,550.00	\$5,070.00	\$5,580.00	\$6,950.00	\$7,340.00
		19 / 15 Ft	\$5,160.00	\$5,690.00	\$6,270.00	\$6,820.00	\$7,380.00	\$9,140.00	\$9,625.00
20 / 16 Ft	\$5,540.00	\$6,140.00	\$6,710.00	\$7,310.00	\$7,890.00	\$10,025.00	\$10,630.00		
Vertical Ends Option Add.	12/8 ft - 14/10 ft \$1,250.00	12/8 ft - 14/10 ft \$1,450.00	12/8 ft - 14/10 ft \$1,500.00	12/8 ft - 14/10 ft \$1,550.00	12/8 ft - 14/10 ft \$1,600.00	12/8 ft - 14/10 ft \$1,700.00	12/8 ft - 14/10 ft \$2,000.00		

➤ Prices may vary by area

➤ Prices are subject to change without notice

NOTE: If you are needing special drawings or wet stamped drawings for your building, there will be an additional charge.

**\*Rent to Own Available** Only In Participating States, and Participating Dealerships



# CERTIFIED STRAIGHT ROOF STYLE BARN 30 PSF



Open ends, gables, and sides.



Fully enclosed leans to, 2 garage doors, 1 walk-in door, and vertical roof.

## STANDARD FEATURES

Straight Roof Barn features include the following: 14 gauge galvanized steel framing spaced at 5' on center or less and 29 gauge metal roofing. The Straight Roof Barn package include leg bracing for additional strength and stability, as well as both front and back gable ends on the main section and both lean-tos of the barn. The base leg heights are 12' & 10' tall. Coast to Coast Carports, Inc. is not responsible for stopping, or repairing leaks under base rails.

### CERTIFIED WIND 140 MPH ADD.

21' Long	26' Long	31' Long	36' Long	40' Long
\$400.00	\$500.00	\$500.00	\$600.00	\$700.00

21' Long	26' Long	31' Long	36' Long	40' Long
14 ga 36 X 21 X 12 <b>\$6,090.00</b> With Vertical Roof: <b>\$6,990.00</b>	14 ga 36 X 26 X 12 <b>\$7,090.00</b> With Vertical Roof: <b>\$8,290.00</b>	14 ga 36 X 31 X 12 <b>\$8,190.00</b> With Vertical Roof: <b>\$10,290.00</b>	14 ga 36 X 36 X 12 <b>\$9,290.00</b> With Vertical Roof: <b>\$11,790.00</b>	14 ga 36 X 40 X 12 <b>\$12,690.00</b> Price Includes Vertical Roof
14 ga 42 X 21 X 12 <b>\$6,490.00</b> With Vertical Roof: <b>\$7,390.00</b>	14 ga 42 X 26 X 12 <b>\$7,590.00</b> With Vertical Roof: <b>\$8,790.00</b>	14 ga 42 X 31 X 12 <b>\$8,690.00</b> With Vertical Roof: <b>\$10,390.00</b>	14 ga 42 X 36 X 12 <b>\$10,090.00</b> With Vertical Roof: <b>\$12,090.00</b>	14 ga 42 X 40 X 12 <b>\$13,390.00</b> Price Includes Vertical Roof
14 ga 44 X 21 X 12 <b>\$6,690.00</b> With Vertical Roof: <b>\$7,590.00</b>	14 ga 44 X 26 X 12 <b>\$7,790.00</b> With Vertical Roof: <b>\$8,990.00</b>	14 ga 44 X 31 X 12 <b>\$9,090.00</b> With Vertical Roof: <b>\$10,490.00</b>	14 ga 44 X 36 X 12 <b>\$10,190.00</b> With Vertical Roof: <b>\$12,390.00</b>	14 ga 44 X 40 X 12 <b>\$13,790.00</b> Price Includes Vertical Roof
14 ga 46 X 21 X 12 <b>\$6,990.00</b> With Vertical Roof: <b>\$7,790.00</b>	14 ga 46 X 26 X 12 <b>\$8,090.00</b> With Vertical Roof: <b>\$9,190.00</b>	14 ga 46 X 31 X 12 <b>\$9,190.00</b> With Vertical Roof: <b>\$10,690.00</b>	14 ga 46 X 36 X 12 <b>\$10,390.00</b> With Vertical Roof: <b>\$12,690.00</b>	14 ga 46 X 40 X 12 <b>\$14,390.00</b> Price Includes Vertical Roof
14 ga 48 X 21 X 12 <b>\$7,190.00</b> With Vertical Roof: <b>\$7,990.00</b>	14 ga 48 X 26 X 12 <b>\$8,390.00</b> With Vertical Roof: <b>\$9,390.00</b>	14 ga 48 X 31 X 12 <b>\$9,390.00</b> With Vertical Roof: <b>\$10,990.00</b>	14 ga 48 X 36 X 12 <b>\$10,590.00</b> With Vertical Roof: <b>\$13,790.00</b>	14 ga 48 X 40 X 12 <b>\$14,990.00</b> Price Includes Vertical Roof

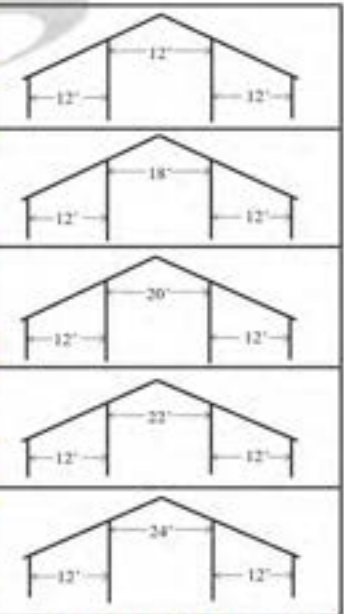

21' Long	26' Long	31' Long	36' Long	40' Long
14 ga 50 X 21 X 12 <b>\$7,490.00</b> With Vertical Roof: <b>\$8,690.00</b>	14 ga 50 X 26 X 12 <b>\$8,890.00</b> With Vertical Roof: <b>\$9,990.00</b>	14 ga 50 X 31 X 12 <b>\$10,090.00</b> With Vertical Roof: <b>\$12,290.00</b>	14 ga 50 X 36 X 12 <b>\$11,390.00</b> With Vertical Roof: <b>\$14,490.00</b>	14 ga 50 X 40 X 12 <b>\$16,090.00</b> Price Includes Vertical Roof
14 ga 54 X 21 X 12 <b>\$7,940.00</b> With Vertical Roof: <b>\$9,140.00</b>	14 ga 54 X 26 X 12 <b>\$9,440.00</b> With Vertical Roof: <b>\$10,740.00</b>	14 ga 54 X 31 X 12 <b>\$10,640.00</b> With Vertical Roof: <b>\$12,940.00</b>	14 ga 54 X 36 X 12 <b>\$12,640.00</b> With Vertical Roof: <b>\$15,340.00</b>	14 ga 54 X 40 X 12 <b>\$16,740.00</b> Price Includes Vertical Roof

### 35 PSF/140 MPH

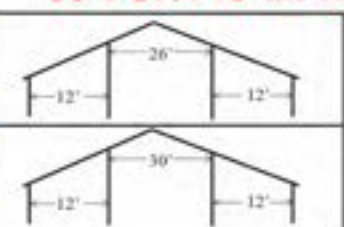

Prices are subject to change without notice Prices may vary by area

NOTE: If you are needing special drawings or wet stamped drawings for your building, there will be an additional charge.

\*Rent to Own Available Only In Participating States, and Participating Dealerships

# STRAIGHT ROOF BARN OPTIONS

LEG HEIGHT		21' Long	26' Long	31' Long	36' Long	41' Long
<b>HEIGHT</b>	12 / 10 Ft	STD	STD	STD	STD	STD
	13 / 11 Ft	\$1,200.00	\$1,500.00	\$1,700.00	\$2,000.00	\$2,300.00
	14 / 12 Ft	\$1,330.00	\$1,700.00	\$1,940.00	\$2,320.00	\$2,650.00
	15 / 13 Ft	\$2,720.00	\$3,480.00	\$3,740.00	\$4,430.00	\$5,110.00
	16 / 14 Ft	\$3,010.00	\$3,620.00	\$4,100.00	\$4,840.00	\$5,540.00
	17 / 15 Ft	\$3,830.00	\$4,550.00	\$4,870.00	\$5,890.00	\$6,610.00
	18 / 16 Ft	\$4,180.00	\$4,720.00	\$5,270.00	\$6,120.00	\$7,065.00
	19 / 17 Ft	\$4,850.00	\$5,410.00	\$5,980.00	\$7,310.00	\$8,040.00
	20 / 18 Ft	\$5,080.00	\$5,675.00	\$6,290.00	\$7,700.00	\$8,490.00

Colonial Style		\$240.00	\$300.00	\$360.00	\$420.00	\$480.00	
LEG HEIGHT		21' Long	26' Long	31' Long	36' Long	41' Long	
<b>BOTH SIDES CLOSED</b>	<b>VERTICAL SIDES INCLUDED</b>	10 Ft	\$950.00	\$1,100.00	\$1,250.00	\$1,350.00	\$1,830.00
		11 Ft	\$1,045.00	\$1,210.00	\$1,375.00	\$1,485.00	\$1,925.00
		12 Ft	\$1,075.00	\$1,310.00	\$1,500.00	\$1,620.00	\$2,015.00
		13 Ft	\$1,225.00	\$1,430.00	\$1,625.00	\$1,755.00	\$2,345.00
		14 Ft	\$1,305.00	\$1,540.00	\$1,750.00	\$1,890.00	\$2,410.00
	15 Ft	\$2,155.00	\$2,695.00	\$3,240.00	\$3,740.00	\$4,315.00	
	16 Ft	\$2,430.00	\$3,020.00	\$3,645.00	\$4,255.00	\$4,855.00	
	17 Ft	\$2,690.00	\$3,355.00	\$4,030.00	\$4,665.00	\$5,335.00	
	18 Ft	\$2,940.00	\$3,680.00	\$4,405.00	\$5,155.00	\$5,875.00	
	19 Ft	\$3,220.00	\$4,015.00	\$4,810.00	\$5,610.00	\$6,415.00	
20 Ft	\$3,470.00	\$4,315.00	\$5,200.00	\$6,045.00	\$6,910.00		
Vertical Sides Option Add.		10 ft - 14 ft \$450.00	10 ft - 14 ft \$525.00	10 ft - 14 ft \$600.00	10 ft - 14 ft \$675.00	10 ft - 14 ft \$750.00	

Colonial Style		\$432.00	\$504.00	\$528.00	\$552.00	\$576.00	\$638.00	\$738.00	
LEG HEIGHT		36' Wide	42' Wide	44' Wide	46' Wide	48' Wide	50' Wide	54' Wide	
<b>CLOSED END (Per End)</b>	<b>VERTICAL ENDS INCLUDED</b>	12 / 10 Ft	\$1,765.00	\$2,125.00	\$2,245.00	\$2,365.00	\$2,485.00	\$2,540.00	\$2,915.00
		13 / 11 Ft	\$1,910.00	\$2,360.00	\$2,510.00	\$2,660.00	\$2,810.00	\$2,885.00	\$3,085.00
		14 / 12 Ft	\$1,995.00	\$2,445.00	\$2,595.00	\$2,745.00	\$2,895.00	\$2,990.00	\$3,170.00
	15 / 13 Ft	\$2,975.00	\$3,210.00	\$3,840.00	\$4,270.00	\$4,660.00	\$4,700.00	\$4,935.00	
	16 / 14 Ft	\$3,170.00	\$3,630.00	\$4,220.00	\$4,560.00	\$4,940.00	\$4,955.00	\$5,115.00	
	17 / 15 Ft	\$4,830.00	\$5,330.00	\$5,840.00	\$6,330.00	\$6,810.00	\$7,770.00	\$8,115.00	
	18 / 16 Ft	\$5,200.00	\$5,730.00	\$6,290.00	\$6,810.00	\$7,320.00	\$8,690.00	\$9,080.00	
	19 / 17 Ft	\$5,750.00	\$6,280.00	\$6,860.00	\$7,410.00	\$7,970.00	\$9,730.00	\$10,215.00	
	20 / 18 Ft	\$6,180.00	\$6,780.00	\$7,350.00	\$7,950.00	\$8,530.00	\$10,665.00	\$11,195.00	
	Vertical Ends Option Add.		12/10 ft - 14/12 ft \$1,250.00	12/10 ft - 14/12 ft \$1,450.00	12/10 ft - 14/12 ft \$1,500.00	12/10 ft - 14/12 ft \$1,550.00	12/10 ft - 14/12 ft \$1,600.00	12/10 ft - 14/12 ft \$1,700.00	12/10 ft - 14/12 ft \$2,000.00

NOTE: If you are needing special drawings or wet stamped drawings for your building, there will be an additional charge.

**\*Rent to Own Available** Only In Participating States, and Participating Dealerships



# CERTIFIED 30 PSF A-FRAME UTILITY CARPORT WITH VERTICAL ROOF

## AND 10 FT ENCLOSURE ON BACK

AS LOW AS

# \$8,673.00

18' x 30' x 7' 14 ga.



(Shown with Options- Window)



CERTIFIED WIND 140 MPH ADD.	30' Long	35' Long	40' Long
	\$250.00	\$300.00	\$350.00
18 x 30 x 6 14 ga	\$3,795.00	\$4,095.00	\$4,595.00
7 ft. leg	\$120.00	\$140.00	\$160.00
Closed Sides	\$328.00	\$328.00	\$328.00
Front	\$815.00	\$815.00	\$815.00
Back	\$815.00	\$815.00	\$815.00
Garage Door 8 x 7	\$600.00	\$600.00	\$600.00
Walk-In Door	\$350.00	\$350.00	\$350.00
4 Openings	\$1,400.00	\$1,400.00	\$2,100.00
Arch Cut End	\$450.00	\$450.00	\$450.00
Price With Options	\$8,673.00	\$8,993.00	\$10,213.00
20 x 30 x 6 14 ga	\$3,895.00	\$4,395.00	\$4,995.00
7 ft. leg	\$120.00	\$140.00	\$160.00
Closed Sides	\$328.00	\$328.00	\$328.00
Front	\$945.00	\$945.00	\$945.00
Back	\$945.00	\$945.00	\$945.00
Garage Door 8 x 7	\$600.00	\$600.00	\$600.00
Walk-In Door	\$350.00	\$350.00	\$350.00
4 Openings	\$1,400.00	\$1,400.00	\$2,100.00
Arch Cut End	\$450.00	\$450.00	\$450.00
Price With Options	\$9,033.00	\$9,553.00	\$10,873.00
22 x 30 x 6 14 ga	\$4,095.00	\$4,695.00	\$5,595.00
8 ft. leg	\$240.00	\$280.00	\$320.00
Closed Sides	\$380.00	\$380.00	\$380.00
Front	\$1,150.00	\$1,150.00	\$1,150.00
Back	\$1,150.00	\$1,150.00	\$1,150.00
Garage Door 9 x 8	\$800.00	\$800.00	\$800.00
Walk-In Door	\$350.00	\$350.00	\$350.00
4 Openings	\$1,400.00	\$1,400.00	\$2,100.00
Arch Cut End	\$450.00	\$450.00	\$450.00
Price With Options	\$10,015.00	\$10,655.00	\$12,295.00
24 x 30 x 6 14 ga	\$4,395.00	\$5,495.00	\$6,195.00
8 ft. leg	\$240.00	\$280.00	\$320.00
Closed Sides	\$380.00	\$380.00	\$380.00
Front	\$1,240.00	\$1,240.00	\$1,240.00
Back	\$1,240.00	\$1,240.00	\$1,240.00
Garage Door 9 x 8	\$800.00	\$800.00	\$800.00
Walk-In Door	\$350.00	\$350.00	\$350.00
4 Openings	\$1,400.00	\$1,400.00	\$2,100.00
Arch Cut End	\$450.00	\$450.00	\$450.00
Price With Options	\$10,495.00	\$11,635.00	\$13,075.00
30 x 30 x 6 14 ga	\$6,095.00	\$6,895.00	\$7,695.00
8 ft. leg	\$240.00	\$280.00	\$320.00
Closed Sides	\$380.00	\$380.00	\$380.00
Front	\$1,675.00	\$1,675.00	\$1,675.00
Back	\$1,675.00	\$1,675.00	\$1,675.00
Garage Door 10' x 8'	\$900.00	\$900.00	\$900.00
Walk-In Door	\$350.00	\$350.00	\$350.00
4 Openings	\$1,400.00	\$1,400.00	\$2,100.00
Arch Cut End	\$575.00	\$575.00	\$575.00
Price With Options	\$13,290.00	\$14,130.00	\$15,670.00
CERTIFIED 30' WIDE:	30 x 35 x 6 14 ga	30 x 35 x 6 14 ga	30 x 40 x 6 14 ga
	\$6,095.00	\$6,895.00	\$7,695.00
	\$240.00	\$280.00	\$320.00
	\$380.00	\$380.00	\$380.00
	\$1,675.00	\$1,675.00	\$1,675.00
	\$1,675.00	\$1,675.00	\$1,675.00
	\$900.00	\$900.00	\$900.00
	\$350.00	\$350.00	\$350.00
	\$1,400.00	\$1,400.00	\$2,100.00
	\$575.00	\$575.00	\$575.00
	\$13,290.00	\$14,130.00	\$15,670.00

These prices include 10' storage, increase 5' more additional \$100.00

NOTE: If you are needing special drawings or wet stamped drawings for your building, there will be an additional charge.



**CERTIFIED 35 Lbs PSF/140 MPH 32 FT - 40 FT WIDE A-FRAME VERTICAL ONLY**



W x L	W x L	W x L	W x L	W x L
32 x 30 \$10,095.00	34 x 30 \$10,595.00	36 x 30 \$11,195.00	38 x 30 \$11,795.00	40 x 30 \$12,395.00
32 x 35 \$11,395.00	34 x 35 \$11,995.00	36 x 35 \$12,495.00	38 x 35 \$13,595.00	40 x 35 \$14,295.00
32 x 40 \$12,795.00	34 x 40 \$13,295.00	36 x 40 \$14,295.00	38 x 40 \$15,495.00	40 x 40 \$16,195.00
32 x 45 \$14,295.00	34 x 45 \$15,295.00	36 x 45 \$16,295.00	38 x 45 \$17,695.00	40 x 45 \$18,495.00
32 x 50 \$15,895.00	34 x 50 \$16,995.00	36 x 50 \$17,995.00	38 x 50 \$18,495.00	40 x 50 \$20,495.00

**OPTION LIST**

HEIGHT	LEG HEIGHT	30' LONG	35' LONG	40' LONG	45' LONG	50' LONG
	8 FT	STD	STD	STD	STD	STD
10 FT	\$675.00	\$770.00	\$865.00	\$960.00	\$1,060.00	
12 FT	\$1,345.00	\$1,540.00	\$1,730.00	\$1,920.00	\$2,115.00	
14 FT	\$2,020.00	\$2,305.00	\$2,595.00	\$2,880.00	\$3,170.00	
16 FT	\$2,685.00	\$3,075.00	\$3,460.00	\$3,840.00	\$4,225.00	
18 FT	\$4,350.00	\$5,390.00	\$5,870.00	\$6,375.00	\$6,880.00	
20 FT	\$5,175.00	\$6,375.00	\$7,040.00	\$7,705.00	\$8,370.00	

COLONIAL STYLE ADD.	\$240.00	\$280.00	\$320.00	\$360.00	\$400.00
---------------------	----------	----------	----------	----------	----------

BOTH SIDES CLOSED	LEG HEIGHT	30' LONG	35' LONG	40' LONG	45' LONG	50' LONG
	8 FT	\$2,325.00	\$2,650.00	\$2,985.00	\$3,285.00	\$3,655.00
10 FT	\$2,580.00	\$2,955.00	\$3,340.00	\$3,660.00	\$4,075.00	
12 FT	\$2,970.00	\$3,390.00	\$3,825.00	\$4,175.00	\$4,640.00	
14 FT	\$3,255.00	\$3,720.00	\$4,200.00	\$4,595.00	\$5,110.00	
16 FT	\$3,685.00	\$4,200.00	\$4,730.00	\$5,170.00	\$5,735.00	
18 FT	\$4,120.00	\$4,680.00	\$5,260.00	\$5,745.00	\$6,355.00	
20 FT	\$4,550.00	\$5,160.00	\$5,790.00	\$6,370.00	\$6,980.00	

COLONIAL STYLE ADD.	\$256.00	\$272.00	\$288.00	\$304.00	\$320.00
---------------------	----------	----------	----------	----------	----------

CLOSED ENDS (PER END)	LEG HEIGHT	32' WIDE	34' WIDE	36' WIDE	38' WIDE	40' WIDE
	8 FT	\$3,220.00	\$3,420.00	\$3,650.00	\$3,850.00	\$4,035.00
10 FT	\$3,510.00	\$3,705.00	\$3,940.00	\$4,140.00	\$4,335.00	
12 FT	\$3,665.00	\$3,860.00	\$4,100.00	\$4,295.00	\$4,490.00	
14 FT	\$3,820.00	\$4,020.00	\$4,250.00	\$4,415.00	\$4,650.00	
16 FT	\$4,110.00	\$4,305.00	\$4,540.00	\$4,740.00	\$4,940.00	
18 FT	\$4,450.00	\$4,670.00	\$4,930.00	\$5,160.00	\$5,375.00	
20 FT	\$4,610.00	\$4,830.00	\$5,090.00	\$5,315.00	\$5,535.00	

EXTRAS	Gable End	
	32' WIDE	\$575.00 each
34' WIDE	\$625.00 each	
36' WIDE	\$675.00 each	
38' WIDE	\$725.00 each	
40' WIDE	\$800.00 each	
Roll-Up Commercial Doors With Chain		
12' x 12'	\$2,495.00	
14' x 14'	\$2,995.00 (Requires lift)	

*NOTE: Customer will need to add fees for drawings and freight on bigger buildings. Customer is also responsible for providing the proper lift (Reach Lift) to ensure a safe and efficient install.*



**NOTE: If you are needing special drawings or wet stamped drawings for your building, there will be an additional charge.**



# 42-70 Ft Wide A-Frame Vertical Only



## Certified 35 LBS PSF/140 MPH 42-70 FT Wide Price List

W x L	Price	W x L	Price	W x L	Price	W x L	Price	W x L	Price
42 x 30	\$14,395.00	44 x 30	\$15,795.00	46 x 30	\$16,995.00	48 x 30	\$18,095.00	50 x 30	\$18,895.00
42 x 35	\$16,095.00	44 x 35	\$17,795.00	46 x 35	\$19,995.00	48 x 35	\$20,395.00	50 x 35	\$21,195.00
42 x 40	\$17,495.00	44 x 40	\$19,795.00	46 x 40	\$21,195.00	48 x 40	\$22,595.00	50 x 40	\$23,495.00
42 x 45	\$20,495.00	44 x 45	\$21,795.00	46 x 45	\$23,295.00	48 x 45	\$24,895.00	50 x 45	\$25,795.00
42 x 50	\$22,695.00	44 x 50	\$23,795.00	46 x 50	\$25,495.00	48 x 50	\$27,195.00	50 x 50	\$27,995.00

W x L	Price	W x L	Price	W x L	Price	W x L	Price	W x L	Price
52 x 30	\$20,395.00	54 x 30	\$20,495.00	56 x 30	\$22,595.00	58 x 30	\$23,795.00	60 x 30	\$24,895.00
52 x 35	\$22,895.00	54 x 35	\$23,195.00	56 x 35	\$25,495.00	58 x 35	\$26,695.00	60 x 35	\$27,995.00
52 x 40	\$25,495.00	54 x 40	\$25,895.00	56 x 40	\$28,295.00	58 x 40	\$29,695.00	60 x 40	\$31,095.00
52 x 45	\$27,995.00	54 x 45	\$28,595.00	56 x 45	\$31,195.00	58 x 45	\$32,695.00	60 x 45	\$34,195.00
52 x 50	\$30,595.00	54 x 50	\$31,295.00	56 x 50	\$34,095.00	58 x 50	\$35,695.00	60 x 50	\$37,395.00

W x L	Price	W x L	Price	W x L	Price	W x L	Price	W x L	Price
62 x 30	\$27,730.00	64 x 30	\$30,130.00	66 x 30	\$30,540.00	68 x 30	\$30,950.00	70 x 30	\$31,830.00
62 x 35	\$35,150.00	64 x 35	\$35,640.00	66 x 35	\$36,130.00	68 x 35	\$36,620.00	70 x 35	\$37,650.00
62 x 40	\$36,440.00	64 x 40	\$36,940.00	66 x 40	\$37,450.00	68 x 40	\$37,600.00	70 x 40	\$39,070.00
62 x 45	\$42,070.00	64 x 45	\$42,650.00	66 x 45	\$42,230.00	68 x 45	\$43,810.00	70 x 45	\$45,060.00
62 x 50	\$47,390.00	64 x 50	\$48,050.00	66 x 50	\$48,710.00	68 x 50	\$49,370.00	70 x 50	\$50,770.00

## WE NOW OFFER INSULATION!!

**THERMAL BARRIER**  
**RADIANT BARRIER**  
**VAPOR BARRIER**



### Sources of Heat Loss in an Uninsulated Wall Cavity

In reality, a large portion of heat is gained/lost by radiant means. Radiant insulation reflects heat that is trying to enter your cool living space, back out so that it never gets to you. This provides for much cooler buildings in the summer. By the same means, if you use a reflective product facing into the building, you will reflect the heat you produce in the winter back into the building.

**Reflective Insulation = Warmer Winters & Cooler Summers**

### Better Alternative

Reflective insulation is a uniquely designed system made from layers of insulating air bubbles encased by a reflective surface. This unique combination delivers a high performance insulating product suitable for all construction and home renovation projects.

#### Summer

Reflects heat away from your living spaces, blocks significant heat gain in your house, and cuts air conditioning costs.

#### Winter

Reflects escaping heat back towards your living spaces, reducing heat loss, and lowering heat bills.

### THERMAL BARRIER:

\* Inside layer made of heat-sealed insulating bubbles. Eliminates convection and conduction heat transfers (can represent 25% of all energy loss/gain in your building).

### RADIANT BARRIER:

\* The highly reflective surface of metallized foil (made of 99% pure aluminum) and white polyethylene eliminates radiant heat transfers (can represent 75% of all energy loss/gain in your building).

### VAPOR BARRIER:

Combined product material acts as vapor barrier. Protects against condensation and mildew.

**The highly reflective surface provides optimal thermal performance:**

- 97% radiant heat reflection
- Acts as a vapor barrier
- Maximize Thermal resistance (R value) without adding significant thickness to the insulation system.
- Helps maintain temperature and humidity distribution of the structure at time of construction
- Can be used on its own, or in conjunction with mass insulation.

**Only**  
**\$1.50**  
**Per Square**  
**Foot**





# OPTION LIST

HEIGHT	LEG HEIGHT	30' LONG	35' LONG	40' LONG	45' LONG	50' LONG
	8 FT	STD	STD	STD	STD	STD
	10 FT	\$675.00	\$770.00	\$865.00	\$960.00	\$1,060.00
	12 FT	\$1,345.00	\$1,540.00	\$1,730.00	\$1,920.00	\$2,115.00
	14 FT	\$2,020.00	\$2,305.00	\$2,595.00	\$2,880.00	\$3,170.00
	16 FT	\$2,685.00	\$3,075.00	\$3,460.00	\$3,840.00	\$4,225.00
	18 FT	\$4,350.00	\$5,390.00	\$5,870.00	\$6,375.00	\$6,880.00
	20 FT	\$5,175.00	\$6,375.00	\$7,040.00	\$7,705.00	\$8,370.00

COLONIAL STYLE ADD.	\$240.00	\$280.00	\$320.00	\$360.00	\$400.00
---------------------	----------	----------	----------	----------	----------

BOTH SIDES CLOSED	LEG HEIGHT	30' LONG	35' LONG	40' LONG	45' LONG	50' LONG
	8 FT	\$2,325.00	\$2,650.00	\$2,985.00	\$3,285.00	\$3,655.00
	10 FT	\$2,580.00	\$2,955.00	\$3,340.00	\$3,660.00	\$4,075.00
	12 FT	\$2,970.00	\$3,390.00	\$3,825.00	\$4,175.00	\$4,640.00
	14 FT	\$3,255.00	\$3,720.00	\$4,200.00	\$4,595.00	\$5,110.00
	16 FT	\$3,685.00	\$4,200.00	\$4,730.00	\$5,170.00	\$5,735.00
	18 FT	\$4,120.00	\$4,680.00	\$5,260.00	\$5,745.00	\$6,355.00
	20 FT	\$4,550.00	\$5,160.00	\$5,790.00	\$6,370.00	\$6,980.00

COLONIAL STYLE ADD.	\$336.00	\$352.00	\$368.00	\$384.00	\$400.00	\$416.00	\$432.00	\$448.00	\$464.00	\$480.00
---------------------	----------	----------	----------	----------	----------	----------	----------	----------	----------	----------

CLOSED ENDS (PER END)	LEG HEIGHT	42' WIDE	44' WIDE	46' WIDE	48' WIDE	50' WIDE	52' WIDE	54' WIDE	56' WIDE	58' WIDE	60' WIDE
	8 FT	\$4,270.00	\$4,390.00	\$4,505.00	\$4,630.00	\$4,740.00	\$4,860.00	\$4,980.00	\$5,100.00	\$5,210.00	\$5,330.00
	10 FT	\$4,600.00	\$4,710.00	\$4,830.00	\$4,950.00	\$5,070.00	\$5,190.00	\$5,300.00	\$5,410.00	\$5,530.00	\$5,650.00
	12 FT	\$4,755.00	\$4,870.00	\$5,030.00	\$5,145.00	\$5,230.00	\$5,340.00	\$5,460.00	\$5,580.00	\$5,700.00	\$5,810.00
	14 FT	\$4,920.00	\$5,040.00	\$5,155.00	\$5,270.00	\$5,390.00	\$5,500.00	\$5,620.00	\$5,740.00	\$5,855.00	\$5,970.00
	16 FT	\$5,080.00	\$5,255.00	\$5,310.00	\$5,430.00	\$5,550.00	\$5,670.00	\$5,790.00	\$5,900.00	\$6,020.00	\$6,130.00
	18 FT	\$5,240.00	\$5,360.00	\$5,470.00	\$5,590.00	\$5,710.00	\$5,830.00	\$5,940.00	\$6,060.00	\$6,180.00	\$6,300.00
	20 FT	\$5,400.00	\$5,520.00	\$5,640.00	\$5,755.00	\$5,870.00	\$5,990.00	\$6,100.00	\$6,220.00	\$6,340.00	\$6,460.00

COLONIAL STYLE ADD.	\$495.00	\$508.00	\$524.00	\$540.00	\$556.00
---------------------	----------	----------	----------	----------	----------

CLOSED ENDS (PER END)	LEG HEIGHT	62' WIDE	64' WIDE	66' WIDE	68' WIDE	70' WIDE
	8 FT	\$5,755.00	\$5,995.00	\$6,295.00	\$6,475.00	\$6,715.00
	10 FT	\$5,995.00	\$6,235.00	\$6,695.00	\$6,915.00	\$6,955.00
	12 FT	\$6,235.00	\$6,475.00	\$6,715.00	\$6,955.00	\$7,195.00
	14 FT	\$6,475.00	\$6,715.00	\$6,955.00	\$7,195.00	\$7,435.00
	16 FT	\$6,715.00	\$6,955.00	\$7,195.00	\$7,435.00	\$7,675.00
	18 FT	\$6,955.00	\$7,195.00	\$7,435.00	\$7,675.00	\$7,915.00
	20 FT	\$7,195.00	\$7,435.00	\$7,675.00	\$7,915.00	\$8,155.00

GABLE END	62' Wide	64' Wide	66' Wide	68' Wide	70' Wide
	\$2,150.00	\$2,350.00	\$2,575.00	\$2,825.00	\$3,075.00

GABLE END	42' WIDE	44' WIDE	46' WIDE	48' WIDE	50' WIDE	52' WIDE	54' WIDE	56' WIDE	58' WIDE	60' WIDE
	\$850.00	\$950.00	\$1,050.00	\$1,150.00	\$1,250.00	\$1,400.00	\$1,500.00	\$1,650.00	\$1,775.00	\$1,950.00

**FRAME OUTS ON SIDE WALL PRICING ( Must Close Sides First)**

- \* Up to 14' \$250.00 with door & \$800.00 without door
- \* 15' to 20' \$950.00
- \* Building must be 2' taller when installing garage door on sides

**End Frame outs For Buildings 32' Wide And Wider**

Width	Height			
	Up to 14' Tall	15' - 16' Tall	17' - 18' Tall	19' to 20' Tall
Up To 12'	\$475.00	\$525.00	\$550.00	\$575.00
13' - 14'	\$525.00	\$550.00	\$600.00	\$625.00
15' - 20'	\$625.00	\$650.00	\$700.00	\$725.00

NOTE: Customer will need to add fees for drawings and freight on bigger buildings. Customer is also responsible for providing the proper lift (Reach Lift) to ensure a safe and efficient install.

NOTE: If you are needing special drawings or wet stamped drawings for your building, there will be an additional charge.





# CERTIFIED SIDE ENTRY CARPORTS 30 PSF

Pricing includes arched cut ends, plus 1 panel with framed openings on each side as follows: 21' - 2 openings, 26' - 2 openings, 31' - 3 openings, 36' - 3 openings, 41' - 4 openings

## Horizontal Roof Side Entry Carports



Ground Certification WIND 140 MPH	21' Long	26' Long	31' Long	36' Long	41' Long	46' Long	51' Long
	\$200.00	\$250.00	\$250.00	\$300.00	\$350.00	\$400.00	\$400.00

14 GAUGE 7 FT. LEGS	12 x 21	\$4,235.00	18 x 21	\$4,635.00	20 x 21	\$4,835.00	22 x 21	\$5,135.00	24 x 21	\$5,335.00
	12 x 26	\$4,605.00	18 x 26	\$5,105.00	20 x 26	\$5,305.00	22 x 26	\$5,605.00	24 x 26	\$5,905.00
	12 x 31	\$5,875.00	18 x 31	\$6,175.00	20 x 31	\$6,775.00	22 x 31	\$6,875.00	24 x 31	\$7,075.00
	12 x 36	\$6,345.00	18 x 36	\$6,645.00	20 x 36	\$7,245.00	22 x 36	\$7,445.00	24 x 36	\$7,645.00

## Vertical Roof Side Entry Carports



Ground Certification WIND 140 MPH	21' Long	26' Long	31' Long	36' Long	41' Long	46' Long	51' Long
	\$200.00	\$250.00	\$250.00	\$300.00	\$350.00	\$400.00	\$400.00

14 GAUGE 7 FT. LEGS	12 x 20	\$4,735.00	18 x 20	\$5,135.00	20 x 20	\$5,335.00	22 x 20	\$5,535.00	24 x 20	\$5,735.00
	12 x 25	\$5,305.00	18 x 25	\$5,805.00	20 x 25	\$6,005.00	22 x 25	\$6,205.00	24 x 25	\$6,405.00
	12 x 30	\$7,175.00	18 x 30	\$7,275.00	20 x 30	\$7,375.00	22 x 30	\$7,575.00	24 x 30	\$7,875.00
	12 x 35	\$7,345.00	18 x 35	\$7,645.00	20 x 35	\$7,945.00	22 x 35	\$8,245.00	24 x 35	\$9,145.00
	12 x 40	\$8,295.00	18 x 40	\$8,995.00	20 x 40	\$9,395.00	22 x 40	\$9,995.00	24 x 40	\$10,595.00
	12 x 45	\$8,645.00	18 x 45	\$9,245.00	20 x 45	\$9,545.00	22 x 45	\$10,145.00	24 x 45	\$10,945.00
	12 x 50	\$9,915.00	18 x 50	\$10,415.00	20 x 50	\$11,115.00	22 x 50	\$11,915.00	24 x 50	\$12,815.00

NOTE: If you are needing special drawings or wet stamped drawings for your building, there will be an additional charge.

\*Rent to Own Available Only In Participating States, and Participating Dealerships



# LOAFING SHED



Shown with Options: Vertical Roof, Gable and Tack Room with Walk-In Door





Shown with Options: Vertical Roof, Gable

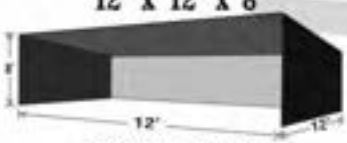
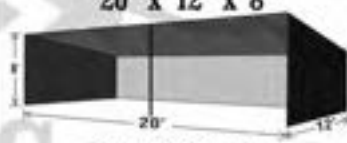

Shown with Options: Gable

**ALL PACKAGES COME IN 2½" 14 GAUGE AND INCLUDES 6 MOBILE HOME ANCHORS**  
**NOTE: Coast to Coast Carports, Inc. is not responsible for impenetrable rocky ground.**

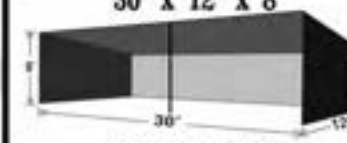
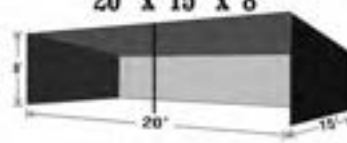
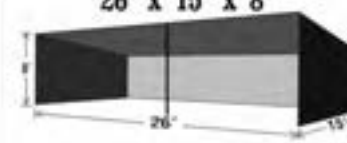
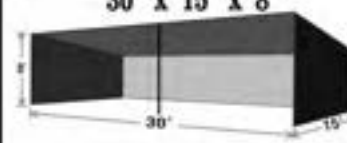
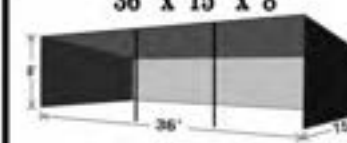
<p>12' x 12' x 8'</p>  <p><b>\$3,640.00</b></p> <p>(INCLUDES 1 EXTRA LEG)</p> <p>For vertical roof add..... \$175.00                      For vertical side &amp; back add..... \$363.00</p>	<p>20' x 12' x 8'</p>  <p><b>\$4,660.00</b></p> <p>(INCLUDES 1 EXTRA LEG)</p> <p>For vertical roof add..... \$200.00                      For vertical side &amp; back add..... \$363.00</p>	<p>26' x 12' x 8'</p>  <p><b>\$5,070.00</b></p> <p>(INCLUDES 1 EXTRA LEG)</p> <p>For vertical roof add..... \$400.00                      For vertical side &amp; back add..... \$388.00</p>	<p>30' x 12' x 8'</p>  <p><b>\$5,485.00</b></p> <p>(INCLUDES 1 EXTRA LEG)</p> <p>For vertical roof add..... \$500.00                      For vertical side &amp; back add..... \$413.00</p>
<p>20' x 15' x 8'</p>  <p><b>\$6,160.00</b></p> <p>(INCLUDES 1 EXTRA LEG)</p> <p>For vertical roof add..... \$200.00                      For vertical side &amp; back add..... \$563.00</p>	<p>26' x 15' x 8'</p>  <p><b>\$7,170.00</b></p> <p>(INCLUDES 1 EXTRA LEG)</p> <p>For vertical roof add..... \$400.00                      For vertical side &amp; back add..... \$588.00</p>	<p>30' x 15' x 8'</p>  <p><b>\$7,705.00</b></p> <p>(INCLUDES 1 EXTRA LEG)</p> <p>For vertical roof add..... \$500.00                      For vertical side &amp; back add..... \$613.00</p>	<p>36' x 15' x 8'</p>  <p><b>\$8,530.00</b></p> <p>(INCLUDES 2 EXTRA LEG)</p> <p>For vertical roof add..... \$600.00                      For vertical side &amp; back add..... \$638.00</p>

## GABLE END

12' - 20'	\$275.00
26'	\$350.00
30' - 36'	\$425.00

**Add a 10' Tack Room With Walk-in Door, & Front Dressing**  
(NOTE: This is NOT an extension to the frame. The 10' enclosure fits inside the base frame size)

12' wide x 10' .....	\$2,130.00
15' wide x 10' .....	\$2,340.00



➤ Prices may vary by area.

➤ Prices are subject to change without notice

NOTE: If you are needing special drawings or wet stamped drawings for your building, there will be an additional charge.

\*Rent to Own Available Only In Participating States, and Participating Dealerships



# CERTIFIED GAMBREL STYLE BARNS 35 Lbs PSF/ 140 MPH



To price a Gambrel Style Barn, simply add the cost from the table below to the All-Vertical Fully Enclosed Building you are interested in.



	20' Long	25' Long	30' Long	35' Long	40' Long	45' Long	50' Long
<b>12' to 20' WIDE</b>	\$1,230.00	\$1,380.00	\$1,560.00	\$1,710.00	\$1,890.00	\$2,040.00	\$2,190.00
<b>22' to 24' WIDE</b>	\$1,710.00	\$1,890.00	\$2,040.00	\$2,190.00	\$2,370.00	\$2,520.00	\$2,700.00
<b>26' to 30' WIDE</b>	\$2,730.00 + DOUBLE LEG OPTION	\$3,120.00 + DOUBLE LEG OPTION	\$3,690.00 + DOUBLE LEG OPTION	\$4,110.00 + DOUBLE LEG OPTION	\$4,500.00 + DOUBLE LEG OPTION	\$4,920.00 + DOUBLE LEG OPTION	\$5,310.00 + DOUBLE LEG OPTION

**NOTE: Lift Required On All Sizes.**

NOTE: Building must be vertical and fully enclosed in order to get Gambrel Style Barn. Customer is also responsible for providing the proper lift (Reach Lift) to ensure a safe and efficient install.



## HOW TO PRICE INSULATION

### 1. ROOF

Add extra feet to width of roof

WIDTH	REGULAR	A-FRAME
12'-22' Wide	2' Add On	2' Add On
24' Wide	2'6" Add On	2'6" Add On
26' Wide	2' Add On	3' Add On
30' Wide	2' Add On	3' Add On
32' Wide		3' Add On
34' - 60' Wide		3' Add On
61' - 70' Wide		10' Add On

1. (Width) + (Extra Ft.) = (Answer)

2. (Answer) x (Length) = Square Footage

3. (Square Footage) x (\$1.50) = Cost

1. (18') + (2') = (20')

2. (20') x (25') = 500'

3. (500') x (\$1.50) = \$750.00

### 2. SIDES

1. (Length) x (Height) = Square Footage

2. (Square Footage) x (\$1.50) = Cost

3. (Cost) x (2) = Both Sides Cost

ONE SIDE COST

1. (25') x (7') = 175'

2. (175') x (\$1.50) = \$262.50

BOTH SIDES COST

\$262.50 x 2 = \$525.00

### 3. ENDS

1. (Leg Height) x (Width) = Square Footage

2. (Square Footage) x (\$1.50) = Cost

ONE END COST

1. (7') x (18') = 126'

2. (126') x (\$1.50) = \$189.00

BOTH ENDS COST

\$189.00 x 2 = \$378.00

**TOTAL**

**\$750.00**

**\$525.00**

**\$378.00**

**\$1,653.00**



EXAMPLE: A-FRAME 18' Wide X 25' Long X 7' Height

NOTE: If you are needing special drawings or wet stamped drawings for your building, there will be an additional charge.

\*Rent to Own Available Only In Participating States, and Participating Dealerships

# 30 Lbs PSF/140 MPH CERTIFIED REINFORCED RV COVERS



## Standard Features **LEG POSTS AND BASERAILS DOUBLED**

- \*14 Gauge
- \*10' Legs
- \*Double Base Rails and Legs
- \*3' Braces
- \*5' on Center or less for added rigidity and strength, and either concrete, or rebar & mobile home anchors included



### A-FRAME Style

14 GAUGE	12 x 21	\$2,965.00	18 x 21	\$3,365.00	20 x 21	\$3,565.00	22 x 21	\$3,865.00	24 x 21	\$4,065.00
	12 x 26	\$3,645.00	18 x 26	\$4,345.00	20 x 26	\$4,345.00	22 x 26	\$4,645.00	24 x 26	\$4,945.00
	12 x 31	\$4,425.00	18 x 31	\$5,325.00	20 x 31	\$5,325.00	22 x 31	\$5,425.00	24 x 31	\$5,625.00
	12 x 36	\$5,155.00	18 x 36	\$6,055.00	20 x 36	\$6,055.00	22 x 36	\$6,255.00	24 x 36	\$6,455.00

### A-FRAME Style With Vertical Roof

14 GAUGE	12 x 20	\$3,465.00	18 x 20	\$3,865.00	20 x 20	\$4,065.00	22 x 20	\$4,265.00	24 x 20	\$4,465.00
	12 x 25	\$4,345.00	18 x 25	\$4,845.00	20 x 25	\$5,045.00	22 x 25	\$5,245.00	24 x 25	\$5,445.00
	12 x 30	\$5,725.00	18 x 30	\$5,825.00	20 x 30	\$5,925.00	22 x 30	\$6,125.00	24 x 30	\$6,425.00
	12 x 35	\$6,155.00	18 x 35	\$6,455.00	20 x 35	\$6,755.00	22 x 35	\$7,055.00	24 x 35	\$7,855.00
	12 x 40	\$6,635.00	18 x 40	\$7,335.00	20 x 40	\$7,735.00	22 x 40	\$8,335.00	24 x 40	\$8,935.00
	12 x 45	\$7,315.00	18 x 45	\$7,915.00	20 x 45	\$8,215.00	22 x 45	\$8,815.00	24 x 45	\$9,615.00
	12 x 50	\$8,145.00	18 x 50	\$8,645.00	20 x 50	\$9,345.00	22 x 50	\$10,145.00	24 x 50	\$11,045.00

## OPTIONS

HEIGHT	LEG HEIGHT	21' Long	26' Long	31' Long	36' Long	41' Long	46' Long	51' Long
	11 Ft	\$80.00	\$100.00	\$120.00	\$140.00	\$160.00	\$180.00	\$200.00
	12 Ft	\$160.00	\$200.00	\$240.00	\$280.00	\$320.00	\$360.00	\$400.00
	13 Ft	\$1,280.00	\$1,600.00	\$1,820.00	\$2,140.00	\$2,460.00	\$2,680.00	\$3,025.00
	14 Ft	\$1,330.00	\$1,700.00	\$1,940.00	\$2,320.00	\$2,650.00	\$2,880.00	\$3,210.00
	15 Ft	\$1,600.00	\$2,080.00	\$2,160.00	\$2,570.00	\$2,970.00	\$3,370.00	\$3,770.00

BOTH SIDES CLOSED	LEG HEIGHT	21' Long	26' Long	31' Long	36' Long	41' Long	46' Long	51' Long
	10 Ft	\$950.00	\$1,100.00	\$1,250.00	\$1,350.00	\$1,830.00	\$2,035.00	\$2,200.00
	11 Ft	\$1,045.00	\$1,210.00	\$1,375.00	\$1,485.00	\$1,925.00	\$2,145.00	\$2,365.00
	12 Ft	\$1,075.00	\$1,310.00	\$1,500.00	\$1,620.00	\$2,015.00	\$2,250.00	\$2,485.00
	13 Ft	\$1,225.00	\$1,430.00	\$1,625.00	\$1,755.00	\$2,345.00	\$2,610.00	\$2,860.00
	14 Ft	\$1,305.00	\$1,540.00	\$1,750.00	\$1,890.00	\$2,410.00	\$2,690.00	\$2,970.00
15 Ft	\$2,155.00	\$2,695.00	\$3,240.00	\$3,740.00	\$4,315.00	\$4,890.00	\$5,470.00	
Vertical Sides Option Add.		\$450.00	\$525.00	\$600.00	\$675.00	\$70.00	\$850.00	\$925.00

**Vertical Sides Included**

CLOSED END (Per End)	LEG HEIGHT	12' Wide	18 Wide	20' Wide	22' Wide	24' Wide
	10 Ft	\$755.00	\$1,115.00	\$1,250.00	\$1,350.00	\$1,440.00
	11 Ft	\$790.00	\$1,150.00	\$1,375.00	\$1,390.00	\$1,510.00
	12 Ft	\$825.00	\$1,185.00	\$1,500.00	\$1,425.00	\$1,545.00
	13 Ft	\$900.00	\$1,350.00	\$1,625.00	\$1,650.00	\$1,800.00
	14 Ft	\$950.00	\$1,400.00	\$1,750.00	\$1,700.00	\$1,850.00
15 Ft	\$1,675.00	\$2,110.00	\$3,240.00	\$2,970.00	\$3,360.00	
Vertical Ends Option Add.		\$450.00	\$650.00	\$600.00	\$700.00	\$800.00

**Vertical Ends Included**

**Mobile Home Anchors 30"**  
\$30.00 EACH  
\$30.00 NOT INSTALLED

NOTE: COAST TO COAST CARPORTS IS NOT RESPONSIBLE FOR IMPENETRABLE ROCKY GROUND.

**\*NOTE: 13' or taller must provide lift.**

➤ Prices may vary by area  
➤ Prices are subject to change without notice

NOTE: If you are needing special drawings or wet stamped drawings for your building, there will be an additional charge.

**\*Rent to Own Available** Only In Participating States, and Participating Dealerships.



# Roof Pitches

## 12'-24' Wide

	20'	25'	30'	35'	40'	45'	50'
2/12	\$500.00	\$650.00	\$800.00	\$950.00	\$1,100.00	\$1,250.00	\$1,400.00
3/12	STD	STD	STD	STD	STD	STD	STD
4/12	\$700.00	\$850.00	\$1,000.00	\$1,150.00	\$1,300.00	\$1,450.00	\$1,600.00
5/12	\$800.00	\$950.00	\$1,100.00	\$1,250.00	\$1,400.00	\$1,550.00	\$1,700.00
6/12	\$900.00	\$1,050.00	\$1,200.00	\$1,350.00	\$1,500.00	\$1,650.00	\$1,800.00

## 25'-30' Wide

	20'	25'	30'	35'	40'	45'	50'
2/12	\$600.00	\$750.00	\$900.00	\$1,050.00	\$1,200.00	\$1,350.00	\$1,500.00
3/12	STD	STD	STD	STD	STD	STD	STD
4/12	\$800.00	\$950.00	\$1,100.00	\$1,250.00	\$1,400.00	\$1,550.00	\$1,700.00
5/12	\$900.00	\$1,100.00	\$1,250.00	\$1,400.00	\$1,550.00	\$1,700.00	\$1,850.00
6/12	\$1,000.00	\$1,150.00	\$1,300.00	\$1,450.00	\$1,600.00	\$1,750.00	\$1,900.00

## 31'-40' Wide

	20'	25'	30'	35'	40'	45'	50'
3/12	STD	STD	STD	STD	STD	STD	STD
4/12	\$950.00	\$1,100.00	\$1,250.00	\$1,400.00	\$1,550.00	\$1,700.00	\$1,850.00
5/12	\$1,050.00	\$1,200.00	\$1,350.00	\$1,500.00	\$1,650.00	\$1,800.00	\$1,950.00
6/12	\$1,150.00	\$1,300.00	\$1,450.00	\$1,600.00	\$1,750.00	\$1,900.00	\$2,050.00

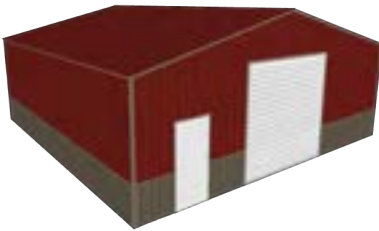

Standard Vertical  
Roof Style 30 x 30 x 10  
3/12 Roof Pitch

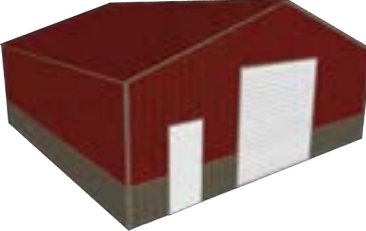

Standard Vertical  
Roof Style 30 x 30 x 10  
4/12 Roof Pitch



Standard Vertical  
Roof Style 30 x 30 x 10  
5/12 Roof Pitch



Standard Vertical  
Roof Style 30 x 30 x 10  
6/12 Roof Pitch

**The customer is responsible for providing the proper reach lift to ensure a safe and efficient install**

A 5,000 lb Telehandler reach lift will be required for buildings 16' tall and higher. The reach height will vary depending upon your buildings leg height and roof pitch.

The lift reach is also required to be able to go up and out.

### How to calculate the correct reach height:

Lets say the leg height on your building is 18', and your roof pitch is 4/12. You would add the height of your legs (18') and the height of your roof (4'), which in this case, would be 22', meaning you would need to provide a 5,000 lb telehandler that reaches up and out to a minimum of 22'



It is also noted that multiple lifts will be required for buildings wider than 60'

NOTE: If you are needing special drawings or wet stamped drawings for your building, there will be an additional charge.

\*Rent to Own Available Only In Participating States, and Participating Dealerships

# LEVELLED LAND AWARENESS

Coast to Coast Carports greatly appreciate your purchase, however, it is imperative that your ground is professionally leveled before the unit can be installed. Coast to Coast Carports and our subcontracted installation crews will not be able to install the structure if any of the following are indicated at the construction site. Please contact your Coast to Coast Carports Customer Service Specialist if you have any questions or concerns.



Wall Installation - 3 Feet Maximum



No Installs on Stacked Blocks



No Installs on Floating Docks



No Installs on Uneven Land

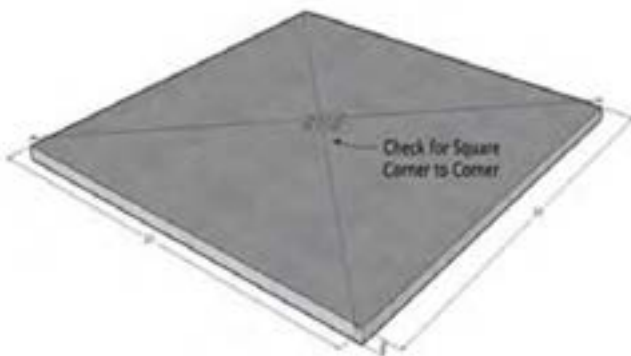

Slab Must Be Level & Square



No Installs on Slopes Over 12"

Buyer ensures Coast To Coast Carports that the ground is professionally level while also acknowledging that if the installation crew is unable to install the structure due to an uneven foundation there will be a return trip fee along with a restock fee that must be paid before returning to the site.

Thank you for your understanding, and once again, we appreciate your business.



# ROOFING AND SIDING COLORS

COAST TO COAST CARPORTS, INC. OFFERS 17 DIFFERENT COLOR OPTIONS THAT YOU CAN CHOOSE FROM, MAKING IT EASIER TO

MATCH THE SURROUNDINGS.



White



Black



Evergreen



Slate Blue



Quaker Gray



Pewter Gray



Earth Brown



Burgundy

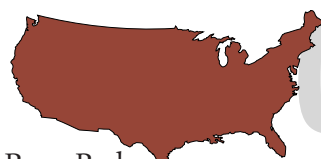

Barn Red

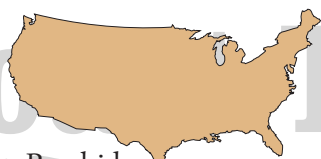

Rawhide



Clay



Pebble Beige



Sandstone



Galvalume



Royal Blue

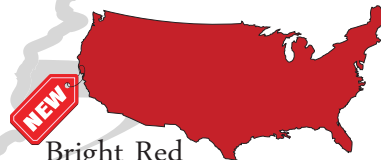

Bright Red



Burnished Slate

COLORS MAY VARY SLIGHTLY

## OPTIONAL GROUND CONCRETE SUPPORT

NOTE: This is not an anchor.



**\$150.00 Each**

RECOMMENDED FOR CARPORTS TALLER THAN 8 FT TO AVOID SWAY.

**WE ACCEPT**



NOTE: If you are needing special drawings or wet stamped drawings for your building, there will be an additional charge.  
NOTE: Site-Specific drawings required on 13' or taller at additional cost.

\*Rent to Own Available Only In Participating States, and Participating Dealerships

## HEARTLAND R.T.O.

- \*No Credit Required
- \*Everyone Pre-Approved
- \*24, 36, 48, or 60 Month Terms
- \*No Penalty for Early Payoff
- \*Financing Range: \$1.2K-\$20K
- \*Customer MUST be the Home/Land Owner of Install Location or Provide A Land Lord Lien Waiver

## ACORN FINANCE

- \*100% Online Application Process Will Not Impact Your Credit Score
- \*Loan Amount Up to \$100K
- \*APR as Low as 4.99%
- \*Terms Up To 12 Years
- \*Funding in 1-2 Days
- \*No Prepayment Fees
- \*FICO- 600 and Above
- \*States Coverage 90% US Population



## SPECIFICATIONS AND ACCESORIES

- \*If you are needing special drawings or wet stamped drawings for your building, there will be an additional charge.
- \*Coast To Coast Carports, Inc. strongly recommends a vertical roof on all buildings over 36' long.
- \*Waiver required on warranty and leaks on horizontal roofs over 36' long
- \*Coast To Coast Carports is not responsible for impenetrable, rocky ground

<b>Extra Panel</b> 21' Long \$130.00 26' Long \$155.00 31' Long \$180.00 36' Long \$205.00	<b>End Frame Out</b> (Must close ends first) Window Frame Out (Up to 30" x 36") \$125.00 Walk-In Door Frame Out (Up To 36" x 80") \$150.00 Garage Door Frame Out On Ends (Up To 12" x 12") \$200.00	<b>Arch End Cut</b> (Must Add Gable End) 6' To 8' \$200.00 (Per End) 9' to 12' \$320.00 (Per End) 13' To 16' \$440.00 (Per End) 12" Wide On Each Side. Must Pair with Gable End	<b>Connect Fees</b> End to End: 12' to 30' Wide \$120.00 Side to Side: 21' Long \$100.00 26' Long \$130.00 31' Long \$150.00 36' Long \$175.00 41' Long \$200.00 46' Long \$225.00 51' Long \$250.00
--	---	--	--

<b>Standard Roll-Up Garage Door</b> 6 x 6 \$550.00 6 x 7 \$550.00 8 x 7 \$600.00 9 x 8 \$800.00 10 x 8 \$900.00 10 x 10 \$1,050.00 Fee to install Roll-Up Doors on side of buildings 12' to 30' wide, is \$100.00	<b>Standard Roll-Up Door Commercial Door With Chain</b> 12' x 12' \$2,495.00 14' x 14' \$2,995.00 Fee to install Roll-Up commercial doors on side of buiding 12' to 30' wide is \$100.00	<b>Mobile Home Anchors</b> \$30.00 Each \$30.00 Not Installed	<b>Asphalt Anchor 30"</b> \$30.00 Each \$30.00 Not Installed	<b>Windows</b> 24" x 36" \$200.00 Each 30" x 36" \$225.00 Each	<b>45 Degree Arch Cut</b> \$100.00 Per Opening 
--	---	---	--	--	---

<b>Walk-In Doors</b> Price for Each*				<b>Welded Center Brace Upgrade</b> 4' Brace recommended for 12' wide bow \$25.00 6' Brace recommended for 18'-20' wide bow \$50.00	
Standard 36" x 80" \$350.00	Six Panel Door 36" x 80" \$400.00	Six Panel w/ Window 36" x 80" \$450.00	Nine Lite 36" x 80" \$550.00	<b>Pin Anchors</b> Temporary at no additional cost	<b>Concrete Anchor Bolts</b> \$10.00 Each 

# ASK YOUR DEALER FOR A QUOTE ON A "CERTIFIED CARPORT"

NOTE: If you are needing special drawings or wet stamped drawings for your building, there will be an additional charge.

Rent to Own Available: Only in Participating States, and Participating Dealerships.



# TESTIMONIALS

## Melissa Fults

Arrived at 7:05, had the carport up & ready to go in an hour. Crew was professional & did a great job!

## Becky Baird Thermopolis, Wyoming

Awesome workers. Super 24x40 enclosed with 2 garage doors and 2 shop doors and time building was incredibly fast and efficient. I bought the workers to go boxes with Mexican food and tipped them well. I can't thank you enough for the fine work.

## Mrs. Sue Sweetma Board Camp Arkansas

I would like to compliment you on your crew, the four young men that came to install my carport were very polite and professional. I was really amazed at how fast they got the job done and it looks fabulous. I would highly recommend Coast-to-Coast to anyone.

**Faster Delivery Times**

**Financing Available**

**Free Delivery & Installation**

**High Quality Products**

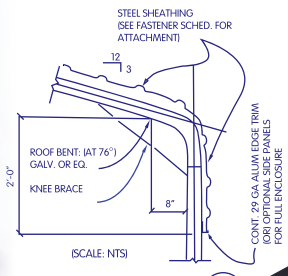
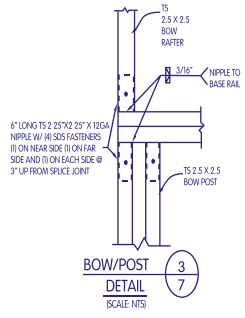

2 1/2" X 14GA. SQ. TUBE



# Great Customer Service

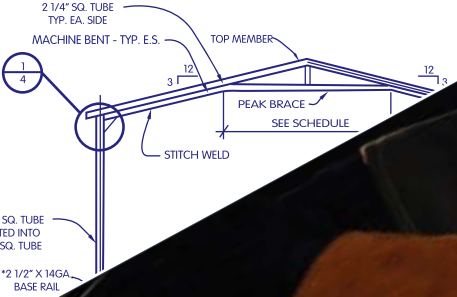

\*2 1/4" SQ. TUBE INSERTED INTO 2 1/2" SQ. TUBE

\*2 1/2" X 14GA. BASE RAIL

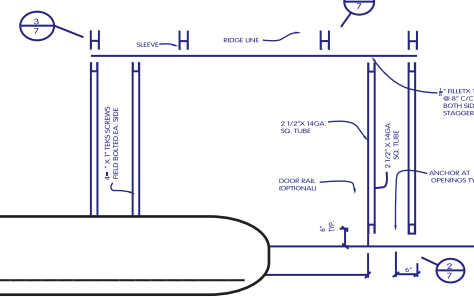
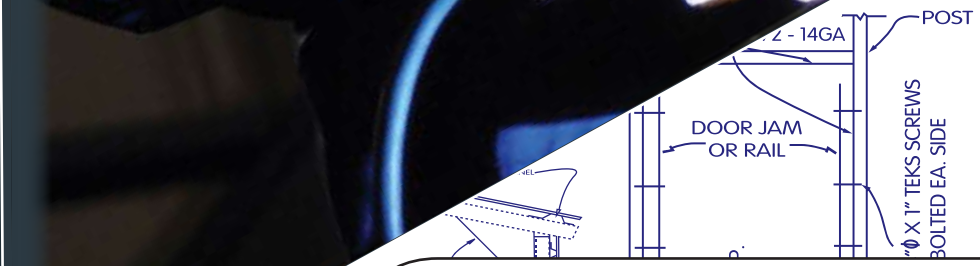
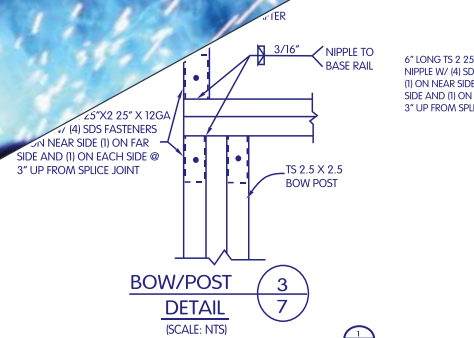

**Call Your Dealer:** \_\_\_\_\_



**WE ACCEPT**



Revised 8-2023

Pricing for: AR, TX, AL, TN, KY, KS, MD, MS, OK, LA, GA