



IAQ Solutions Inc.

© 2019 IAQ Solutions Inc.  
Lubbock, Texas U.S.A.

10/2019  
10311904

# Commercial Air Handler / Induct

## 2008 PCP™ Compound Induct Photocatalytic Oxidation Technology (PCO)

### Installation and Maintenance Instructions for All 2008 PCP Compounds

#### General

The Populated Catalyst Panel (PCP) Compound is used to reduce the levels of Volatile Organic Compounds (VOC's) and viable airborne biological contaminants in airstreams, such as Air Handling Units (AHU's), Roof-Top Units (RTU's) or in the duct work. The PCP Compound is a "scalable" technology, it may be engineered for any size air stream using combinations of standard sizes, or by designing custom units for the non-standard pathways. The Compound is comprised of 1-3 PCP Standards joined together. All IAQ Solutions products incorporate GAP™ 3-step Synergistic technology: MERV 13 Filtration, UVGI Lamps and Photocatalysis.

#### Shipping and Packing List

- 1 - Populated catalyst panel
- 1 - Electrical Whip (Power Module Panel Only)

#### Accessories Options

- Power Kill Box
- Fan Proof Switch
- Door Micro Switches
- Catalyst Racks

#### Nomenclature

- XXXX
- 2440 = 24" Height / 40" Length (Nominal)

#### Packaged Unit Description

- 56 = Power Unit Compound (Line Voltage Input)
- 57 = Center Section Compound
- 58 = End Section Compound

#### WARNING



Electric shock hazard  
Can cause injury of death  
Disconnect all remote electrical power supplies before servicing.  
Access panels must be in place during operation.

#### WARNING



UVC light hazard. UVC light can cause temporary or permanent loss of vision and sunburn. Take proper precautions to protect eyes and skin from direct exposure.

#### WARNING!

Mercury Hazard. Do not Break  
Each UVC lamp contains a small amount of Mercury.  
In case of breakage use proper disposal techniques on page 5-6.

#### WARNING!

Improper installation, adjustment, alteration, service or maintenance can cause property damage, personal injury or loss of life. Installation and service must be performed by a qualified installer or service agency.

#### Clearance and Requirements

**Maximum Air Speed:** 500 fpm

**Pressure drop:** .05 in wc

**UVGI life cycle:** 12,000 operation hours

**Installation location:** After filtration

**Installation location preference:** Downstream of evap. coil in saturated zone

**Clearance from AHU to nearest obstacle:** Clearance must be at least the distance of the length longest compound installed in the system.

## Dimension/Specifications

### Safety Certifications

UL Classified UL File No. E326567  
FIFRA...EPA EST No. 877447--TX--001  
OSHPD: OSP-0307-10



### UL REQUIREMENTS

- 105°C minimum supply connections
- For catalyst marked “XXXX”, 50°C/122°F maximum ambient temperature. For those marked “XXXX-E”, 80°C/176°F maximum ambient temperature.
- Suitable for air-handling units
- Access above ceiling may be required
- The health aspects associated with the use of this product and its ability to aid in disinfection of environment air have not been investigated by UL.
- Use only First Light type T5 lamps specified by the PCP Compound.
- **Warning:** *The electrical supply circuit connected to this UV appliance must be routed through an electrical interlock switch placed on the HVAC system duct access panels and doors to prevent accidental UV exposure when servicing the air ducts or equipment.*
- **Caution:** *Equipment Damage Hazard. Ultraviolet light can cause color shift or surface degradation and sometimes structural degradation of non-metallic components. Select mounting location that prevents exposure to plastic flexible duct components, polyurethane foam insulation material, rubber hoses, wiring insulation, filtration media, etc. If mounting options are limited, items above should be protected with ultraviolet resistant material such as aluminum foil, aluminum duct tape, or metallic shields.*

### Dimensional Data

The standard sizes for the PCP Compounds are found in the chart below. The first dimension is the measurement of the panel across the lamps; the second measurement is along the lamps (see figure).

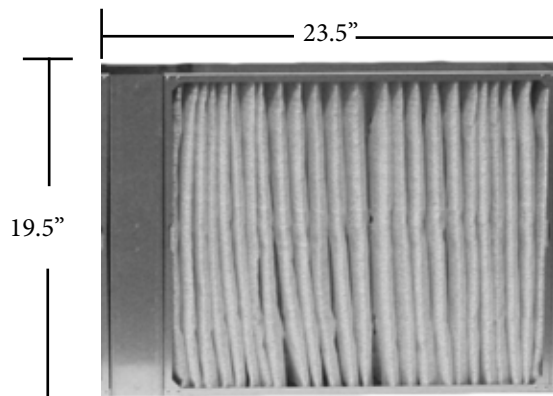

20x24 PCP Standard

All dimensions are nominal; actual dimensions are listed in the table below. All PCP Compounds are 6” deep nominal; actual dimension is 5 13/16”. The catalyst is pleated at one pleat per inch. The lamps are spaced 6” from each other on all models, then centered over the width of the panel. All PCP Compounds are rated at 500 fpm. As residence time is the most critical factor in designing a viable solution, do not exceed 500 fpm.

Complete List of PCP Compounds by IAQ Solutions 11.11.11																
PROPRIETARY AND CONFIDENTIAL																
	#	Height	Width	Built From Standards			Actual Height	Total Length	Lamps	Lamp Length	Amp per Lamp	Total Amps	UVC Watts	Approx Weight Gal, lbs.	Approx Weight SS, lbs.	Approx Weight Al, lbs.
1212	1	12	12	12			11.5	14.938	2	12"	0.224	0.45	7	7.348	6.488	5.286
1216	2	12	16	16			11.5	18.938	2	16"	0.296	0.59	9	8.224	7.364	6.162
1220	3	12	20	20			11.5	22.938	2	20"	0.367	0.73	15	9.099	8.239	7.038
1221	4	12	21	21			11.5	24.063	2	20"	0.367	0.73	15	9.335	8.475	7.273
1224	5	12	24	24			11.5	26.938	2	24"	0.519	1.04	18	9.975	9.115	7.913
1228	6	12	28	16	12		11.5	30.438	2	28"	0.604	1.21	21	12.327	11.030	9.218
1232	7	12	32	22	9		11.5	34.438	2	31"	0.659	1.32	24	13.203	11.906	10.093
1233	8	12	33	24	9		11.5	35.938	2	31"	0.659	1.32	24	13.489	12.192	10.379
1236	9	12	36	24	12		11.5	38.438	2	36"	0.752	1.50	27	14.078	12.781	10.969
1237	10	12	37	24	13		11.5	39.688	2	36"	0.752	1.50	27	14.331	13.034	11.221
1240	11	12	40	20	20		11.5	42.438	2	40"	0.844	1.69	30	14.954	13.657	11.845
1241	12	12	41	21	20		11.5	43.563	2	40"	0.844	1.69	30	15.190	13.892	12.080
1244	13	12	44	24	20		11.5	46.438	2	44"	0.908	1.82	32	15.829	14.532	12.720
1245	14	12	45	24	21		11.5	47.563	2	44"	0.908	1.82	32	16.065	14.768	12.956
1246	15	12	46	24	22		11.5	48.938	2	44"	0.908	1.82	32	16.334	15.037	13.225
1248	16	12	48	24	24		11.5	50.438	2	48"	0.981	1.96	36	16.705	15.408	13.596
1252	17	12	52	24	16	12	11.5	53.938	2	51.5"	1.033	2.07	38.5	19.057	17.323	14.900
1253	18	12	53	24	20	9	11.5	55.438	2	51.5"	1.033	2.07	38.5	19.343	17.609	15.186
1256	19	12	56	24	22	9	11.5	57.938	2	55"	1.105	2.21	41	19.933	18.199	15.776
1257	20	12	57	24	24	9	11.5	59.438	2	55"	1.105	2.21	41	20.219	18.485	16.062
1259	21	12	59	21	21	17	11.5	61.688	2	59"	1.17	2.34	44	20.690	18.956	16.533
1260	22	12	60	24	24	12	11.5	61.938	2	59"	1.17	2.34	44	20.808	19.074	16.652
1261	23	12	61	24	24	14a	11.5	63.438	2	59"	1.17	2.34	44	21.095	19.360	16.938
1262	24	12	62	24	24	14b	11.5	64.188	2	59"	1.17	2.34	44	21.280	19.546	17.123
1612	25	16	12	12			15.5	14.938	3	12"	0.224	0.67	7	9.753	8.556	6.883
1616	26	16	16	16			15.5	18.938	3	16"	0.296	0.89	9	10.741	9.544	7.871
1620	27	16	20	20			15.5	22.938	3	20"	0.367	1.10	15	11.730	10.532	8.860
1621	28	16	21	21			15.5	24.063	3	20"	0.367	1.10	15	11.994	10.796	9.124
1624	29	16	24	24			15.5	26.938	3	24"	0.519	1.56	18	12.718	11.521	9.848
1628	30	16	28	16	12		15.5	30.438	3	28"	0.604	1.81	21	15.855	14.030	11.482
1632	31	16	32	22	9		15.5	34.438	3	31"	0.659	1.98	24	16.843	15.019	12.470
1633	32	16	33	24	9		15.5	35.938	3	31"	0.659	1.98	24	17.157	15.333	12.784
1636	33	16	36	24	12		15.5	38.438	3	36"	0.752	2.26	27	17.831	16.007	13.458
1637	34	16	37	24	13		15.5	39.688	3	36"	0.752	2.26	27	18.112	16.288	13.739
1640	35	16	40	20	20		15.5	42.438	3	40"	0.844	2.53	30	18.820	16.995	14.447
1641	36	16	41	21	20		15.5	43.563	3	40"	0.844	2.53	30	19.084	17.259	14.711
1644	37	16	44	24	20		15.5	46.438	3	44"	0.908	2.72	32	19.808	17.984	15.435
1645	38	16	45	24	21		15.5	47.563	3	44"	0.908	2.72	32	20.072	18.248	15.699
1646	39	16	46	24	22		15.5	48.938	3	44"	0.908	2.72	32	20.370	18.545	15.996
1648	40	16	48	24	24		15.5	50.438	3	48"	0.981	2.94	36	20.797	18.972	16.424
1652	41	16	52	24	16	12	15.5	53.938	3	51.5"	1.033	3.10	38.5	23.933	21.482	18.057
1653	42	16	53	24	20	9	15.5	55.438	3	51.5"	1.033	3.10	38.5	24.247	21.796	18.371
1656	43	16	56	24	22	9	15.5	57.938	3	55"	1.105	3.32	41	24.922	22.470	19.045
1657	44	16	57	24	24	9	15.5	59.438	3	55"	1.105	3.32	41	25.236	22.784	19.360
1659	45	16	59	21	21	17	15.5	61.688	3	59"	1.17	3.51	44	25.764	23.312	19.887
1660	46	16	60	24	24	12	15.5	61.938	3	59"	1.17	3.51	44	25.910	23.458	20.034
1661	47	16	61	24	24	14a	15.5	63.438	3	59"	1.17	3.51	44	26.224	23.773	20.348
1662	48	16	62	24	24	14b	15.5	64.188	3	59"	1.17	3.51	44	26.438	23.986	20.562
1728	49	17	28	25			17	28.000	3	24"	0.519	1.56	18	14.000	12.392	10.142
2012	50	20	12	12			19.5	14.938	3	12"	0.224	0.67	7	11.014	9.556	7.518

2016	51	20	16	16			19.5	18.938	3	16"	0.296	0.89	9	12.115	10.657	8.619
2020	52	20	20	20			19.5	22.938	3	20"	0.367	1.10	15	13.217	11.758	9.721
2021	53	20	21	21			19.5	24.063	3	20"	0.367	1.10	15	13.509	12.050	10.013
2024	54	20	24	24			19.5	26.938	3	24"	0.519	1.56	18	14.318	12.859	10.822
2028	55	20	28	16	12		19.5	30.438	3	28"	0.604	1.81	21	17.970	15.770	12.698
2032	56	20	32	22	9		19.5	34.438	3	31"	0.659	1.98	24	19.071	16.872	13.799
2033	57	20	33	24	9		19.5	35.938	3	31"	0.659	1.98	24	19.414	17.214	14.141
2036	58	20	36	24	12		19.5	38.438	3	36"	0.752	2.26	27	20.173	17.973	14.900
2037	59	20	37	24	13		19.5	39.688	3	36"	0.752	2.26	27	20.481	18.282	15.209
2040	60	20	40	20	20		19.5	42.438	3	40"	0.844	2.53	30	21.274	19.074	16.001
2041	61	20	41	21	20		19.5	43.563	3	40"	0.844	2.53	30	21.566	19.366	16.293
2044	62	20	44	24	20		19.5	46.438	3	44"	0.908	2.72	32	22.375	20.175	17.103
2045	63	20	45	24	21		19.5	47.563	3	44"	0.908	2.72	32	22.667	20.468	17.395
2046	64	20	46	24	22		19.5	48.938	3	44"	0.908	2.72	32	22.993	20.793	17.720
2048	65	20	48	24	24		19.5	50.438	3	48"	0.981	2.94	36	23.476	21.277	18.204
2052	66	20	52	24	16	12	19.5	53.938	3	51.5"	1.033	3.10	38.5	27.128	24.188	20.080
2053	67	20	53	24	20	9	19.5	55.438	3	51.5"	1.033	3.10	38.5	27.471	24.530	20.422
2056	68	20	56	24	22	9	19.5	57.438	3	55"	1.105	3.32	41	28.230	25.289	21.181
2057	69	20	57	24	24	9	19.5	59.438	3	55"	1.105	3.32	41	28.572	25.631	21.523
2059	70	20	59	21	21	17	19.5	61.688	3	59"	1.17	3.51	44	29.156	26.216	22.107
2060	71	20	60	24	24	12	19.5	61.938	3	59"	1.17	3.51	44	29.331	26.390	22.282
2061	72	20	61	24	24	14a	19.5	63.438	3	59"	1.17	3.51	44	29.673	26.733	22.624
2062	73	20	62	24	24	14b	19.5	64.188	3	59"	1.17	3.51	44	29.915	26.974	22.866
2412	74	24	12	12			23.5	14.938	4	12"	0.224	0.90	7	13.285	11.527	9.071
2416	75	24	16	16			23.5	18.938	4	16"	0.296	1.18	9	14.499	12.741	10.285
2420	76	24	20	20			23.5	22.938	4	20"	0.367	1.47	15	15.713	13.955	11.500
2421	77	24	21	21			23.5	24.063	4	20"	0.367	1.47	15	16.033	14.275	11.820
2424	78	24	24	24			23.5	26.938	4	24"	0.519	2.08	18	16.927	15.169	12.714
2428	79	24	28	16	12		23.5	30.438	4	28"	0.604	2.42	21	21.229	18.578	14.875
2432	80	24	32	22	9		23.5	34.438	4	31"	0.659	2.64	24	22.443	19.792	16.089
2433	81	24	33	24	9		23.5	35.938	4	31"	0.659	2.64	24	22.814	20.163	16.460
2436	82	24	36	24	12		23.5	38.438	4	36"	0.752	3.01	27	23.657	21.006	17.303
2437	83	24	37	24	13		23.5	39.688	4	36"	0.752	3.01	27	23.994	21.343	17.640
2440	84	24	40	20	20		23.5	42.438	4	40"	0.844	3.38	30	24.871	22.220	18.517
2441	85	24	41	21	20		23.5	43.563	4	40"	0.844	3.38	30	25.192	22.541	18.838
2444	86	24	44	24	20		23.5	46.438	4	44"	0.908	3.63	32	26.085	23.434	19.731
2445	87	24	45	24	21		23.5	47.563	4	44"	0.908	3.63	32	26.406	23.755	20.052
2446	88	24	46	24	22		23.5	48.938	4	44"	0.908	3.63	32	26.759	24.109	20.405
2448	89	24	48	24	24		23.5	50.438	4	48"	0.981	3.92	36	27.299	24.649	20.945
2452	90	24	52	24	16	12	23.5	53.938	4	51.5"	1.033	4.13	38.5	31.601	28.057	23.107
2453	91	24	53	24	20	9	23.5	55.438	4	51.5"	1.033	4.13	38.5	31.972	28.428	23.477
2456	92	24	56	24	22	9	23.5	57.938	4	55"	1.105	4.42	41	32.815	29.272	24.321
2457	93	24	57	24	24	9	23.5	59.438	4	55"	1.105	4.42	41	33.186	29.642	24.691
2459	94	24	59	21	21	17	23.5	61.688	4	59"	1.17	4.68	44	33.827	30.283	25.332
2460	95	24	60	24	24	12	23.5	61.938	4	59"	1.17	4.68	44	34.030	30.486	25.535
2461	96	24	61	24	24	14a	23.5	63.438	4	59"	1.17	4.68	44	34.400	30.856	25.905
2462	97	24	62	24	24	14b	23.5	64.188	4	59"	1.17	4.68	44	34.670	31.126	26.175

For the PCP Compounds "XXXX-E", the external ballast tray(s) are remotely located using 3', 6' or 10' cords to power the lamps. Contact the factory if greater lengths are necessary. Otherwise the "XXXX" model has the ballast mounted directly to the Standard panels inside the 3 3/16" spacer. See example below.

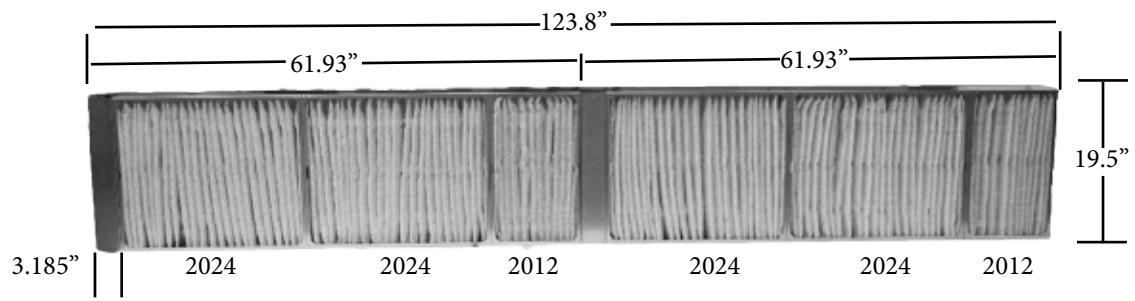

2 2060 PCP Compounds

Pressure Drop Across PCP Panel

PCP Standard 24"x24"x6" Pressure Drop

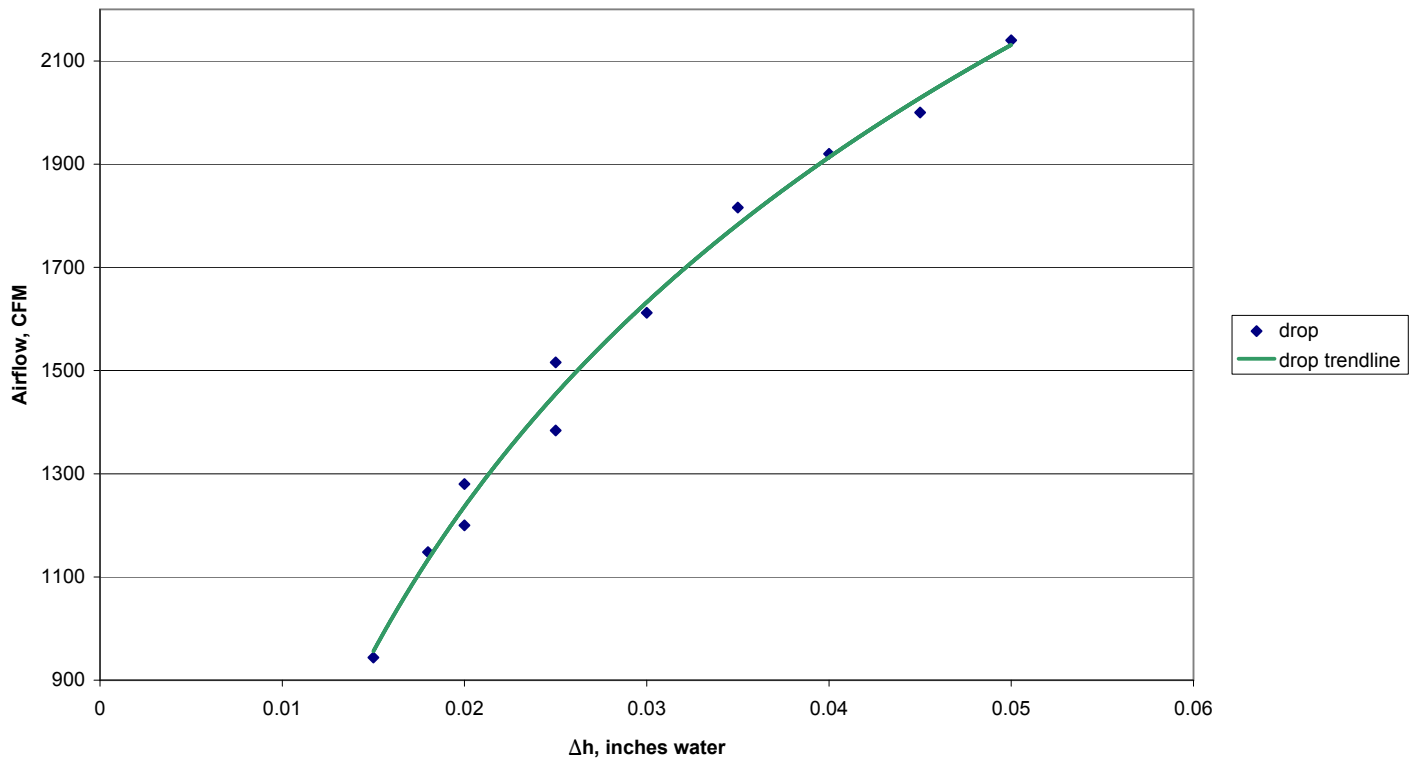

## UVGI Lamps

**IAQ Solutions Inc. lamps do not produce ozone!** The lamps provide a minimum intensity of 775 microwatts/cm<sup>2</sup> (5 milliwatts per square inch) at 10.77 centimeters (4.24") to activate the catalyst effectively. To maintain tested performance, lamps may not be substituted with another manufacturer's products. These lamps provide UV-C wavelengths @ 254 nm. All lamps must be replaced every 16 months (12000 hrs) of continuous use to maintain intensity requirements. IAQ Solutions lamps contain trace amounts of mercury, encapsulated within the lamp and therefore reducing risk to the consumer or ecosphere.

### LAMP SERVICE

**ALL UNITS MUST BE POWERED DOWN BEFORE REPLACING LAMPS.**

**ALL MAINTENANCE PERSONNEL MUST WEAR UV PROTECTIVE SAFETY GLASSES. ALL EXPOSED SKIN MUST BE PROTECTED BY UV RESISTANT CLOTHING.**

### GENERAL

To operate effectively, the lamps must be replaced every 16 months, as the intensity of the lamps decreases over time. The catalyst must be energized by the lamps to create the field of hydroxyl radicals that is required to remove VOC's and biologicals. Without the proper lamp output, VOC's and biologicals will not be reduced!

### INSPECTION

- **To inspect the lamps, the lamps must be powered. Wear UV resistant face shields and personal protective equipment!**
- On all units, inspect the green mounting sleeves (Green Sleeve) on the unit. If the lamps are lit, they will emit a bright green glow.
- If any lamp is unlit, power off the unit. Unplug the wiring harness from the lamp and plug the harness onto a lamp known to be operational. Power on the unit. If the new lamp does not light, the problem could be in the ballast. Keep in mind that the safety switch will not allow the lamps to light if the filter grille door is open. **THIS IS NOT CONSIDERED POWERING DOWN THE UNIT!** A pressure-kill box is an accessory that provides electricians with single point to wire to and two safety devices. One will kill power to the lamps when pressure drops below a set point, and the other kills power to the lamps when an access door is opened. A momentary safety bypass, also included, will allow power to bypass the safeties to power the lamps for visual inspection.
- If the new lamp lights, the old lamp is faulty. Proceed to removal.

### Removal

- **Power the IAQ Solutions Inc. unit down using the kill switch or breaker to unit.**
- **Caution! The lamps may be hot! Wear gloves to protect hands.**
- Unplug the harness from the faulty lamp.
- Unscrew the GreenSleeve from the base of the unit and remove lamp with sleeve from the unit.

### Disposal

- Mercury produces a hazardous waste. Every form of it is toxic and yet mercury is an essential element in millions of fluorescent lamps throughout the United States and millions more throughout the world. State and federal regulatory agencies are working to reduce mercury releases to the environment. Since January 1, 2000, the United States Environmental Protection Agency (USEPA) has allowed for spent lamps to be managed as Universal Wastes. The Universal Waste Rules (UWR) are designed in part to simplify the management of mercury-containing wastes including spent fluorescent lamps. The Rules are also intended to encourage recycling, thereby reducing mercury emissions to the environment.

## Installation

- Installation is the reverse of removal
- Push socket onto lamp pins until socket butts against lamp



## Catalyst

- ALL UNITS MUST BE POWERED DOWN BEFORE SERVICING.
- ALL MAINTENANCE PERSONNEL MUST WEAR UV PROTECTIVE FACE SHIELDS. ALL EXPOSED SKIN MUST BE PROTECTED BY UV RESISTANT CLOTHING.

## General

IAQ Solutions recommends catalyst replacement every fifteen years to provide an efficient system. As debris and contaminants accumulate on the catalyst, the effectiveness of the catalyst is decreased. The catalyst must be inspected periodically for buildup of particulate.

## Inspection

- Power down the unit undergoing inspection.
- Locate the IAQ Solutions PCP Compound in question.
- Visually inspect each catalyst wearing UV protective clothing and face shields. If the catalyst appears clean and free of particulate, proceed to the next unit. If the catalyst cannot be seen, continue to next item.
- Remove some of the lamps. With a flashlight, visually inspect the catalyst through the holes.
- If the catalyst appears clean and free of particulate, replace lamps and proceed to the next AHU. Otherwise, proceed to removal.

## WARNING!

The lamps must be properly maintained to create the hydroxyl radical field. This means the lamps must be on, functioning when intended and within their useful life of 16 months/12,000 hours. Without the lamps operating properly, performance will be completely diminished. Failure to maintain the lamps will **VOID THE WARRANTY** by using the panels as they were not intended, thereby damaging the panels beyond repair, in which Genesis Air Inc. will recommend panel replacement.

## Cleaning

- Light to moderate dust buildup: Disconnect power, use a hand sprayer with water only and rinse the catalyst. Avoid heavy concentrations of spray on ballast tray.
- Resin, E.T.S. or grease: Remove and spray catalyst liberally with Special HD Calgon Coil Cleaner. Allow to sit 20 minutes, then wash off with pump up water spray bottle. Do not remove installation reminders!
- Allow catalyst to lightly dry before returning to service.

## Removal

- If catalyst will be cleaned and reused, keep track of which area the catalyst came from so they will be returned from where they were removed. This will prevent installation problems. Write or draw on the metal frames to help with installation.
- Remove all lamps from the catalyst.
- Remove from the rack. *You may need to contact the installer.*

### **WARNING!**

**High pressure spray will damage the windowing in the catalyst substrate**

## Power

Ballasts are matched to the specific length of lamp. To maintain tested performance, ballasts may not be substituted with another manufacturer's products. The ballasts must be specified either 120v or 240v, 60 Hz: contact the factory for other voltage/frequency requirements. The ballast operating temperature range is -20°F to 158°F.

## Safety

### UVGI

Ultraviolet germicidal irradiation (UVGI) used for the activation of the PCO Catalyst. The residual light can be used for irradiating the evap. coil surface for biological microorganisms but presents a variety of potential health hazards to humans as well, including eye damage, skin burns, and even has the potential to cause skin cancer. Because germicidal UV rays are invisible to the eye, humans may be subject to hazardous doses of UV long before they realize it. There is no Occupational Safety and Health Administration (OSHA) standard for exposure to ultraviolet light. UV can be associated with adverse health effects depending on duration of exposure and the wavelength. The adverse health effects that may occur are erythema (sunburn), photokeratitis (a feeling of sand in the eyes), skin cancer, melanoma, cataracts, and retinal burns. Since maintenance personnel may be accidentally exposed to the radiation from UV lamps while in the course of their duties, it is essential that all UV sources and facilities be adequately labeled to instruct such personnel of the danger of exposure (in some cases, these warnings should be in both English and Spanish; Danger – Ultraviolet Radiation > Peligro -- Radiación Ultravioleta). Ideally, all activated UV sources should either be attended by knowledgeable personnel at all times.

- DISCONNECT ALL POWER TO SYSTEM BEFORE SERVICING
- PROPER **SAFETY GLASSES** OR FACE SHIELD MUST BE WORN WHEN INSPECTING OPERATIONAL LAMPS
- PROPER CLOTHING MUST BE WORN TO COVER EXPOSED SKIN
- **ALL ENTRY DOORS THAT HAVE DIRECT SITE TO THE CATALYST MUST HAVE SAFETY LIMIT SWITCHES INSTALLED TO SHUT OFF LAMPS DURING ENTRY INTO AHU.**
- ALL VIEWING WINDOWS OR PORTS MUST BE HAVE UV RESISTANT AND FILTERING PROPERTIES. **NO GLASS IS PERMITTED**
- Harden all plastic in direct site of the catalyst (Foil Tape)
- All field wiring when possible should be in metal conduit or of a UV resistant type.
- In case of lamp breakage the lamps are incased in a Teflon coating to reduce any chance of glass or mercury of entering the air stream.



## Installation

### Installation Examples

#### Side Load

For when an access door is available with proper clearance in front of the access door.



#### Front Load

For when no door is available and standing room and proper clearances inside the AHU or duct is available.

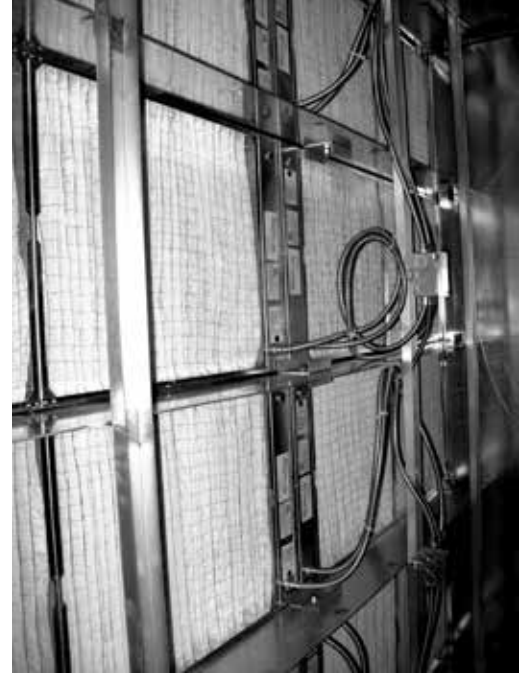

### WARNING!

Do not use silicone to seal catalyst racks to floor or ceiling. The presence of silicone in UV light will pollute the catalyst.

### WARNING!

Sharp edges hazard.  
Equipment sharp edges can cause injuries  
Use protective gloves when grasping equipment edges.

### WARNING!

#### Unpacking required

Remove all protective packing material from the box before removal of catalyst panel. All packing material should be discarded properly.

### WARNING!

#### Lamps contain Mercury.

Ingestion or contact with mercury or mercury vapor is hazardous to your health.  
Take care when handling lamps. If broken, avoid contact with mercury

### Where to place PCP Standard and Compounds

Third party testing has shown the ideal location is the #4 in the saturated zone down stream of filtration.

Where does IAQ Solutions panels fit into an airstream?

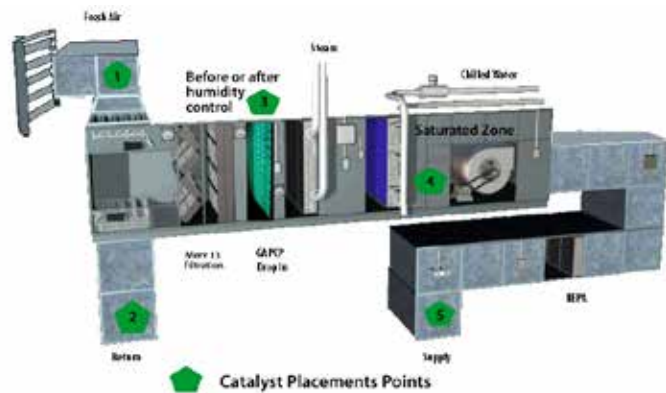

Objective	Location	Solution
Reduce contaminants before entering the AHU	1	<p>Example – fresh air intake located near heliport</p> <ul style="list-style-type: none"> <li>• Recommended for general IAQ to reduce TVOC and viable biologics entering unit</li> <li>• Ideal for IAQ Solutions PCP Compounds or 2008LB</li> <li>• Note: metal pre-filter required</li> </ul>
Reduce contaminants leaving particular areas or offices from mixing into air stream	2	<ul style="list-style-type: none"> <li>• Example – Funeral home body prep; coroner’s office; branch on common return with contamination problems (must have filter grille upstream)</li> </ul>
Reduce contaminants entering unit in mixed air stream after filter bank	3	<ul style="list-style-type: none"> <li>• Reduces viable biologics and particulate load</li> <li>• Ideal for IAQ Solutions Compounds</li> <li>• This placement is preferred when typical RH is 15% or more</li> <li>• Note: May accelerate filter degradation!</li> </ul>
Reduce risk of viable biohazards entering supply duct by prohibiting biologics and mold from accumulating on the cooling coil	4	<ul style="list-style-type: none"> <li>• Example – Accessory filter section to bathe coils in UV-C light</li> <li>• Ideal for IAQ Solutions PCP Compounds</li> <li>• These units are a cost-effective solution if the end user is requesting UV-C lamps since PCP Compounds will reduce biolevels as well as prohibit buildup on surfaces</li> <li>• This location is preferred when typical upstream RH is below 15%</li> </ul>
Lengthen HEPA life by reducing load of contaminants upstream of HEPA	5	<ul style="list-style-type: none"> <li>• Reduces viable biologics and particulate load</li> <li>• Typical applications include clean rooms and operating suites</li> <li>• Ideal for IAQ Solutions PCP Compounds</li> <li>• Renders captured contaminants non-viable</li> </ul>

## Fan Proof Switch

A fan proofing switch is used to control the on-off operations of the lamps. The Dwyer Model 1910-0 switch is mounted in the Kill Box, with 1/4" compression fittings protruding out of the bottom left side of the NEMA 4 Panel for 1/4 copper tubing. The left connection is for positive pressure. The right is for negative pressure.

When choosing an air sampling location these factors should be considered.

1. What is the operating pressure inside the air handling unit?
2. Are there multiple fan walls in the units as in figure 1?

A consistent pressure reading is necessary to properly operate the system. **An improper installation can damage lamps and contactors by short-cycling. This will not be covered under warranty.**

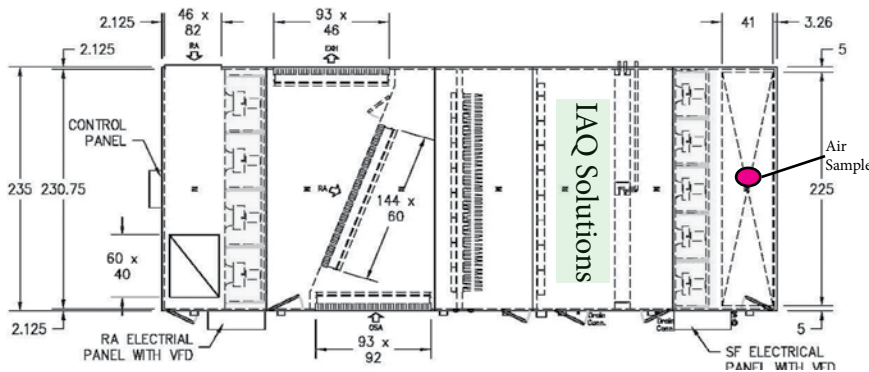

1/4 inch copper tubing is to be supplied by the installer.

## Door Safety Limit Switch

Door interlocks are required at all hinged access doors with direct sight to the catalyst panels to meet UL certifications and to prevent accidental UV exposure when servicing the equipment. These are provided by the installer. Low voltage connections are provided at the pressure kill box on terminal TB3 (slots A & B).

## OSHPD

For OSHPD seismic compliance installations contact the engineering department at IAQ Solutions for specs and compliance.

California hospitals as defined in Section 129725 and licensed pursuant to subdivision (a) of Section 1250 of the Health & Safety Code shall comply with the regulations developed by OSHPD as mandated by SB 1953. Most OSHPD program regulations are found in Division 7 of Title 22 of the California Code of Regulations (CCR), commencing with §90001.

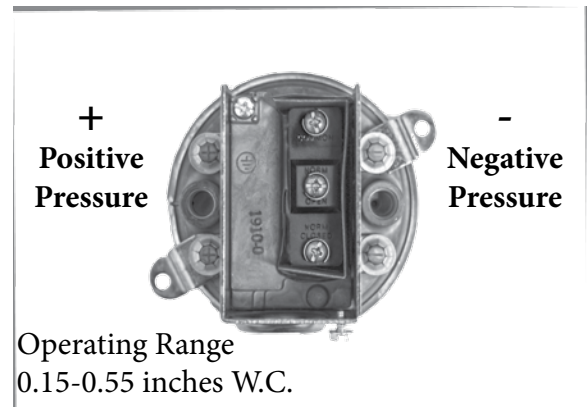

For non-100% fresh air AHUs with single fan walls that are downstream from GA equipment, it is recommended to sample the air flow after the filtration near the lamps for negative pressure.

If there are two fan walls, upstream and downstream, it is recommended to sample the air flow for positive pressure on the supply side as in figure 1.



### SEQUENCE OF OPERATION

WHENEVER AIR FLOW IS SENSED BY DPS-1 AND UNIT ACCESS DOOR IS CLOSED, CONTACTOR C-1 IS ENERGIZED TO BRING ON UV BALLASTS. IF ACCESS DOOR IS OPEN, C-1 IS DE-ENERGIZED. A MANUAL OVERRIDE MOMENTARY PUSHBUTTON PB-1, LOCATED ON THE CONTROL ENCLOSURE DOOR, IS PROVIDED. IF THIS BUTTON IS PRESSED, DPS-1 AND DOOR SWITCH WILL BE BYPASSED TO ENERGIZE C-1 TO BRING ON UV BALLASTS.

CURRENT SENSOR CS-1 IS AVAILABLE AS AN OPTION TO MONITOR UV BALLAST ON/OFF STATUS. CS-1 NORMALLY OPEN CONTACTS ARE WIRED IN SERIES FOR BMS USE.

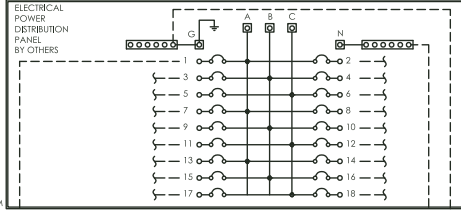

OPT 1: W1 TO ATMOSPHERE, W2 TO NEGATIVE PRESSURE AIRSTREAM  
OPT 2: W1 TO POSITIVE PRESSURE AIRSTREAM, W2 TO ATMOSPHERE

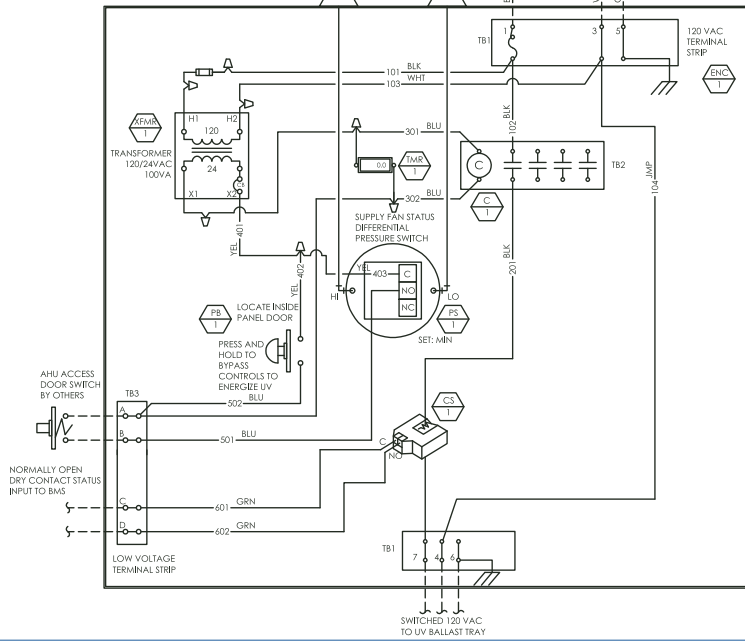

### BILL OF MATERIALS

SYMBOL	QTY	MANUFACTURER AND MODEL NUMBER	DESCRIPTION
C-1	1	ABB A16-40L-00-81	FOUR POLE, NORMALLY OPEN, 30A CONTACTOR, 24 VAC COIL, DIN RAIL MOUNTED
CS-1	1	SENEVA C2320L	MINI SLIT CORE CURRENT SENSOR, NORMALLY OPEN, ADJUSTABLE SETPOINT
ENC-1	1	UNIVERSAL 20206 WITH PREFABBED BACKPANEL	NEMA TYPE 4, 20" X 20" X 6" GASKETED DOOR ENCLOSURE WITH PANEL
PB-1	1	ABB MPM1-10 1NO MCB-10B MEPY1-0 (1 Y/LG)	RED MUSHROOM MOMENTARY PUSH-BUTTON WITH ONE NORMALLY OPEN CONTACT AND ENCLOSURE
PS-1	1	DWYER 1910-0	DIFFERENTIAL PRESSURE SWITCH, SPDT, 0.15" TO 0.55" WC
TMR-1	1	REDINGTON MODEL 34	ELECTRONIC HOUR METER 24V
XFMR-1	1	FUNCTIONAL DEVICES/RIB TR100VA002	UL CLASS 2, 120/24 VAC, 100 VA TRANSFORMER WITH CIRCUIT BREAKER
		ABB D4/6.2L, PR30, BAM2, MB10/24.SF, BJD1.6.2, CS-R1, ABB-5045	TERMINAL BLOCKS, MOUNTING HARDWARE AND ACCESSORIES INCLUDING WIRING DUCT

### IAQ SOLUTIONS CONTROL WIRING DIAGRAM Model No. 1CKB-4 NOT TO SCALE

	I/O Solutions The natural path to clean air	I/O Solutions CONTROL WIRING DIAGRAM
	Proprietary and Confidential www.iaqsolutionsinc.net	1 CIRCUIT KILL BOX REFERENCE Sheet 01 of 01 Date: 12.12.12

### SEQUENCE OF OPERATION

WHENEVER AIR FLOW IS SENSED BY DPS-1 AND UNIT ACCESS DOOR IS CLOSED, CONTACTOR C-1 IS ENERGIZED TO BRING ON UV BALLASTS. IF ACCESS DOOR IS OPEN, C-1 IS DE-ENERGIZED. A MANUAL OVERRIDE MOMENTARY PUSHBUTTON PB-1, LOCATED ON THE CONTROL ENCLOSURE DOOR, IS PROVIDED. IF THIS BUTTON IS PRESSED, DPS-1 AND DOOR SWITCH WILL BE BYPASSED TO ENERGIZE C-1 TO BRING ON UV BALLASTS.

CURRENT SENSORS CS-1 THROUGH CS-2 ARE AVAILABLE AS OPTIONS TO MONITOR UV BALLAST ON/OFF STATUS. CS-1 THROUGH CS-2 NORMALLY OPEN CONTACTS ARE WIRED IN SERIES FOR BMS USE.

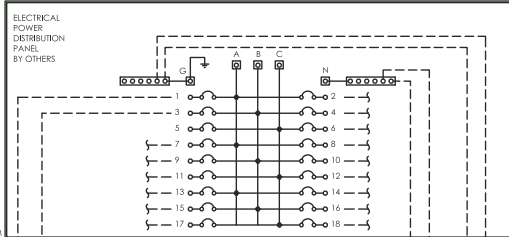

OPT 1: W1 TO ATMOSPHERE, W2 TO NEGATIVE PRESSURE AIRSTREAM  
 OPT 2: W1 TO POSITIVE PRESSURE AIRSTREAM, W2 TO ATMOSPHERE

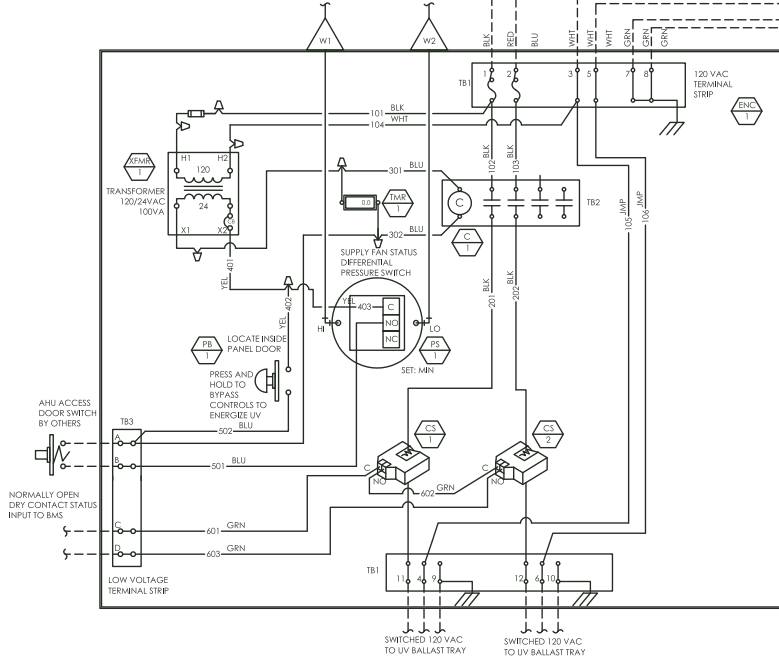

BILL OF MATERIALS			
SYMBOL	QTY	MANUFACTURER AND MODEL NUMBER	DESCRIPTION
C-1	1	ABB A16-40L-00-81	FOUR POLE, NORMALLY OPEN, 30A CONTACTOR, 24 VAC COIL, DIN RAIL MOUNTED
CS-1 THRU CS-2	2	SENAVA C2320L	MINI SLIT CORE CURRENT SENSOR, NORMALLY OPEN, ADJUSTABLE SETPOINT
ENC-1	1	UNIVERSAL 20206 WITH PREFABBED BACKPANEL	NEMA TYPE 4, 20" X 20" X 6" GASKETED DOOR ENCLOSURE WITH PANEL
PB-1	1	ABB MPM1-10 1NO MCB-10B MEPY1-0 (1 Y/LG)	RED MUSHROOM MOMENTARY PUSH-BUTTON WITH ONE NORMALLY OPEN CONTACT AND ENCLOSURE
PS-1	1	DWYER 1910-0	DIFFERENTIAL PRESSURE SWITCH, SPDT, 0.15" TO 0.55" WC
TMR-1	1	REDINGTON MODEL 34	ELECTRONIC HOUR METER 24V
XFMR-1	1	FUNCTIONAL DEVICES/RIB TR100VA002	UL CLASS 2, 120/24 VAC, 100 VA TRANSFORMER WITH CIRCUIT BREAKER
		ABB D4/6.2L, PR30, BAM2, MB10/24.5F, BJD6.2, CS-R1, ABB-5045	TERMINAL BLOCKS, MOUNTING HARDWARE AND ACCESSORIES INCLUDING WIRING DUCT

**IAQ SOLUTIONS CONTROL WIRING DIAGRAM**  
 Model No. 2CKB-4 NOT TO SCALE

**IAQ SOLUTIONS**

CONTROL WIRING DIAGRAM

2 CIRCUIT KILL BOX

REFERENCE

Sheet 01 of 01 Date: 12.12.12

1 2 3 4 5 6 7 8 9 10 11 12

### SEQUENCE OF OPERATION

WHENEVER AIR FLOW IS SENSED BY DPS-1 AND UNIT ACCESS DOOR IS CLOSED, CONTACTOR C-1 IS ENERGIZED TO BRING ON UV BALLASTS. IF ACCESS DOOR IS OPEN, C-1 IS DE-ENERGIZED. A MANUAL OVERRIDE MOMENTARY PUSHBUTTON PB-1, LOCATED ON THE CONTROL ENCLOSURE DOOR, IS PROVIDED. IF THIS BUTTON IS PRESSED, DPS-1 AND DOOR SWITCH WILL BE BYPASSED TO ENERGIZE C-1 TO BRING ON UV BALLASTS.

CURRENT SENSORS CS-1 THROUGH CS-3 ARE AVAILABLE AS OPTIONS TO MONITOR UV BALLAST ON/OFF STATUS. CS-1 THROUGH CS-3 NORMALLY OPEN CONTACTS ARE WIRED IN SERIES FOR BMS USE.

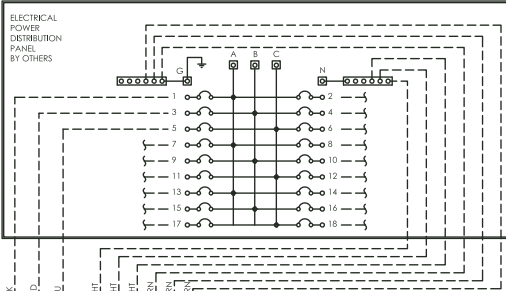

OPT 1: W1 TO ATMOSPHERE, W2 TO NEGATIVE PRESSURE AIRSTREAM  
 OPT 2: W1 TO POSITIVE PRESSURE AIRSTREAM, W2 TO ATMOSPHERE

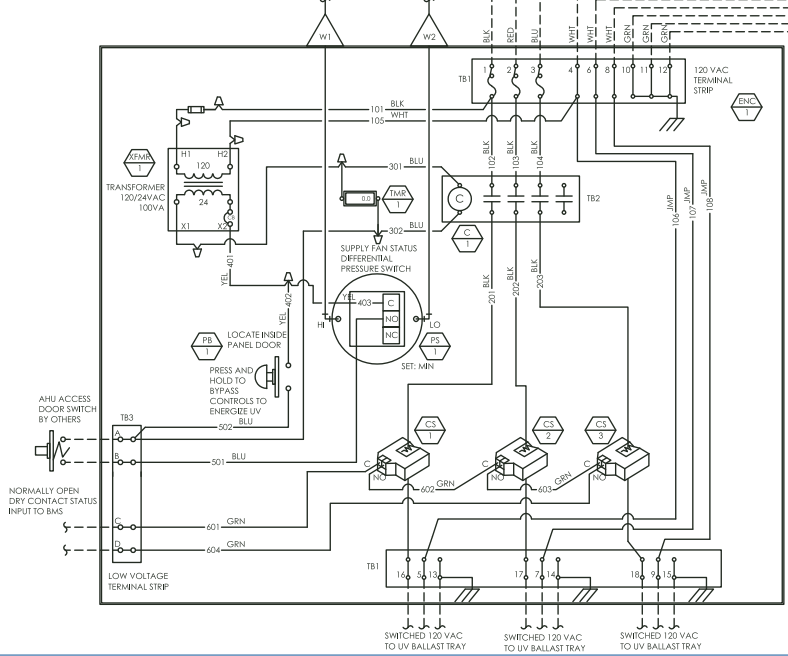

BILL OF MATERIALS			
SYMBOL	QTY	MANUFACTURER AND MODEL NUMBER	DESCRIPTION
C-1	1	ABB A16-40L-00-81	FOUR POLE, NORMALLY OPEN, 30A CONTACTOR, 24 VAC COIL, DIN RAIL MOUNTED
CS-1 THRU CS-3	3	SENAVA C2320L	MINI SLIT CORE CURRENT SENSOR, NORMALLY OPEN, ADJUSTABLE SETPOINT
ENC-1	1	UNIVERSAL 20206 WITH PREFABBED BACKPANEL	NEMA TYPE 4, 20" X 20" X 6" GASKETED DOOR ENCLOSURE WITH PANEL
PB-1	1	ABB MPM1-10 1NO MCB-10B MEPY1-0 (1 Y/LG)	RED MUSHROOM MOMENTARY PUSH-BUTTON WITH ONE NORMALLY OPEN CONTACT AND ENCLOSURE
PS-1	1	DWYER 1910-0	DIFFERENTIAL PRESSURE SWITCH, SPDT, 0.15" TO 0.55" WC
TMR-1	1	REDINGTON MODEL 34	ELECTRONIC HOUR METER 24V
XFMR-1	1	FUNCTIONAL DEVICES/RIB TR100VA002	UL CLASS 2, 120/24 VAC, 100 VA TRANSFORMER WITH CIRCUIT BREAKER
		ABB D4/6.2L, PR30, BAM2, MB10/24.SF, BJD.L6.2, CS-R1, ABB-5045	TERMINAL BLOCKS, MOUNTING HARDWARE AND ACCESSORIES INCLUDING WIRING DUCT

**IAQ SOLUTIONS CONTROL WIRING DIAGRAM**  
 Model No. 3CKB-4 NOT TO SCALE



**IAQ Solutions**  
The natural path to clean air

Proprietary and Confidential  
www.iaqsolutionsinc.net

**IAQ SOLUTIONS**

CONTROL WIRING DIAGRAM

3 CIRCUIT KILL BOX

REFERENCE

Sheet 01 of 01 Date: 12.12.12



### SEQUENCE OF OPERATION

WHENEVER AIR FLOW IS SENSED BY DPS-1 AND UNIT ACCESS DOOR IS CLOSED, CONTACTOR C-1 IS ENERGIZED TO BRING ON UV BALLASTS. IF ACCESS DOOR IS OPEN, C-1 IS DE-ENERGIZED. A MANUAL OVERRIDE MOMENTARY PUSH-BUTTON PB-1, LOCATED ON THE CONTROL ENCLOSURE DOOR, IS PROVIDED. IF THIS BUTTON IS PRESSED, DPS-1 AND DOOR SWITCH WILL BE BYPASSED TO ENERGIZE C-1 TO BRING ON UV BALLASTS.

CURRENT SENSORS CS-1 THROUGH CS-5 ARE AVAILABLE AS OPTIONS TO MONITOR UV BALLAST ON/OFF STATUS. CS-1 THROUGH CS-5 NORMALLY OPEN CONTACTS ARE WIRED IN SERIES FOR BMS USE.

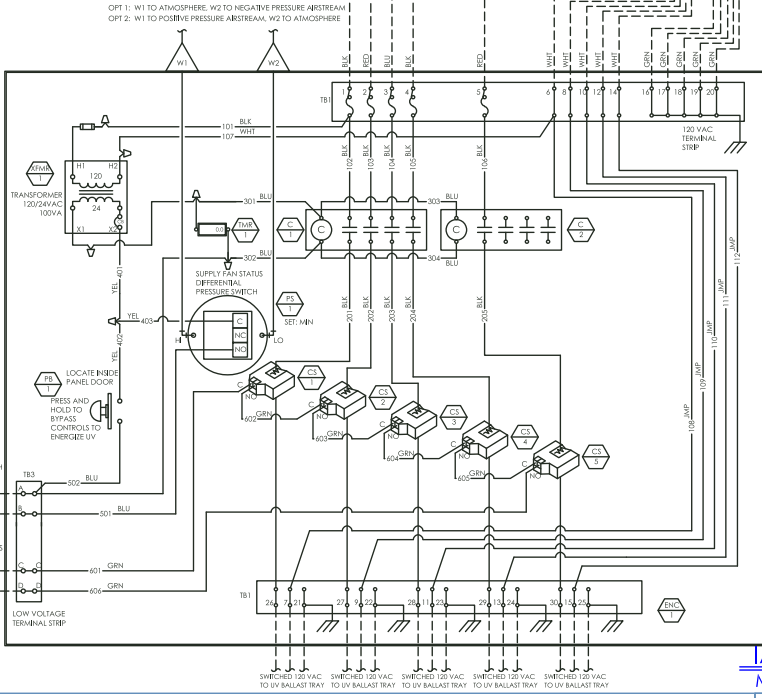
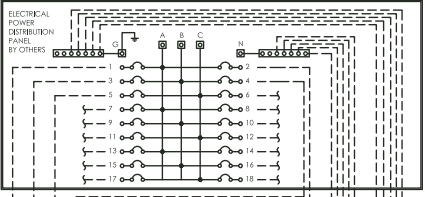

BILL OF MATERIALS			
SYMBOL	QTY	MANUFACTURER AND MODEL NUMBER	DESCRIPTION
C-1, 2	2	ABB A16-40L-00-81	FOUR POLE, NORMALLY OPEN, 30A CONTACTOR, 24 VAC COIL, DIN RAIL MOUNTED
CS-1 THRU CS-5	5	SENA C2320L	MINI SLIT CORE CURRENT SENSOR, NORMALLY OPEN, ADJUSTABLE SETPOINT
ENC-1	1	UNIVERSAL 20206 WITH PREFABBED BACKPANEL	NEMA TYPE 4, 20" X 20" X 6" GASKETED DOOR ENCLOSURE WITH PANEL
PB-1	1	ABB MPM1-10 1NO MCB-10B MEPPY-0 (1 Y/LG)	RED MUSHROOM MOMENTARY PUSH-BUTTON WITH ONE NORMALLY OPEN CONTACT AND ENCLOSURE
PS-1	1	DWYER 1910-0	DIFFERENTIAL PRESSURE SWITCH, SPDT, 0.15" TO 0.55" WC
TMR-1	1	REDINGTON MODEL 34	ELECTRONIC HOUR METER 24VAC
XFMR-1	1	FUNCTIONAL DEVICES/RIB TR100VA002	UL CLASS 2, 120/24 VAC, 100 VA TRANSFORMER WITH CIRCUIT BREAKER
		ABB D4/6.2L, PR30, BAM2, MB10/24.SF, BJD6.2, CS-R1, ABB-5045	TERMINAL BLOCKS, MOUNTING HARDWARE AND ACCESSORIES INCLUDING WIRING DUCT

### IAQ SOLUTIONS CONTROL WIRING DIAGRAM Model No. 5CKB-4 NOT TO SCALE

Proprietary and Confidential  
www.iaqsolutionsinc.net

**IAQ SOLUTIONS**  
CONTROL WIRING DIAGRAM

Part: 5 CIRCUIT KILL BOX  
Rev: REFERENCE

Sheet 01 of 01 Date: 12.12.12



### SEQUENCE OF OPERATION

WHENEVER AIR FLOW IS SENSED BY DPS-1 AND UNIT ACCESS DOOR IS CLOSED, CONTACTOR C-1 IS ENERGIZED TO BRING ON UV BALLASTS. IF ACCESS DOOR IS OPEN, C-1 IS DE-ENERGIZED. A MANUAL OVERRIDE MOMENTARY PUSH-BUTTON PB-1, LOCATED ON THE CONTROL ENCLOSURE DOOR, IS PROVIDED. IF THIS BUTTON IS PRESSED, DPS-1 AND DOOR SWITCH WILL BE BYPASSED TO ENERGIZE C-1 TO BRING ON UV BALLASTS.

CURRENT SENSORS CS-1 THROUGH CS-6 ARE AVAILABLE AS OPTIONS TO MONITOR UV BALLAST ON/OFF STATUS. CS-1 THROUGH CS-6 NORMALLY OPEN CONTACTS ARE WIRED IN SERIES FOR BMS USE.

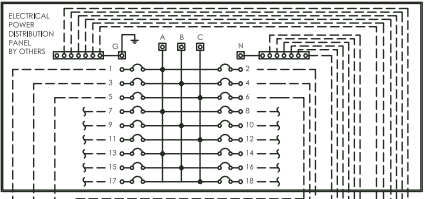

OPT 1: W1 TO ATMOSPHERE, W2 TO NEGATIVE PRESSURE AIRSTREAM  
 OPT 2: W1 TO POSITIVE PRESSURE AIRSTREAM, W2 TO ATMOSPHERE

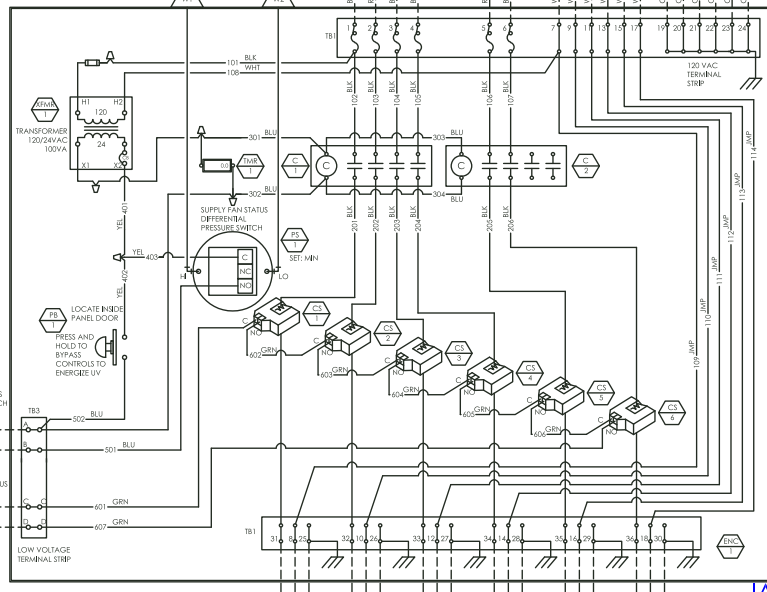

### BILL OF MATERIALS

SYMBOL	QTY	MANUFACTURER AND MODEL NUMBER	DESCRIPTION
C-1, 2	2	ABB A16-40L-00-81	FOUR POLE, NORMALLY OPEN, 30A CONTACTOR, 24 VAC COIL, DIN RAIL MOUNTED
CS-1 THRU CS-6	6	SENA C2320L	MINI SLIT CORE CURRENT SENSOR, NORMALLY OPEN, ADJUSTABLE SETPOINT
ENC-1	1	UNIVERSAL 20206 WITH PREFABBED BACKPANEL	NEMA TYPE 4, 20" X 20" X 6" GASKETED DOOR ENCLOSURE WITH PANEL
PB-1	1	ABB MPM1-10 1NO MCB-10B MEPY1-0 (1 Y/LG)	RED MUSHROOM MOMENTARY PUSH-BUTTON WITH ONE NORMALLY OPEN CONTACT AND ENCLOSURE
PS-1	1	DWYER 1910-0	DIFFERENTIAL PRESSURE SWITCH, SPDT, 0.15" TO 0.55" WC
TMR-1	1	REDINGTON MODEL 34	ELECTRONIC HOUR METER 24VAC
XFMR-1	1	FUNCTIONAL DEVICES/RIB TR100VA002	UL CLASS 2, 120/24 VAC, 100 VA TRANSFORMER WITH CIRCUIT BREAKER
		ABB D4/6.2L, PR30, BAM2, MB10/24.SF, BJD6.2, CS-R1, ABB-5045	TERMINAL BLOCKS, MOUNTING HARDWARE AND ACCESSORIES INCLUDING WIRING DUCT

### IAQ SOLUTIONS CONTROL WIRING DIAGRAM Model No. 6CKB-4 NOT TO SCALE



Proprietary and Confidential  
www.iaqsolutionsinc.net

IAQ SOLUTIONS	
CONTROL WIRING DIAGRAM	
6 CIRCUIT KILL BOX	
REFERENCE	
Sheet 01 of 01	Date: 12.12.12

# Control Kill Box

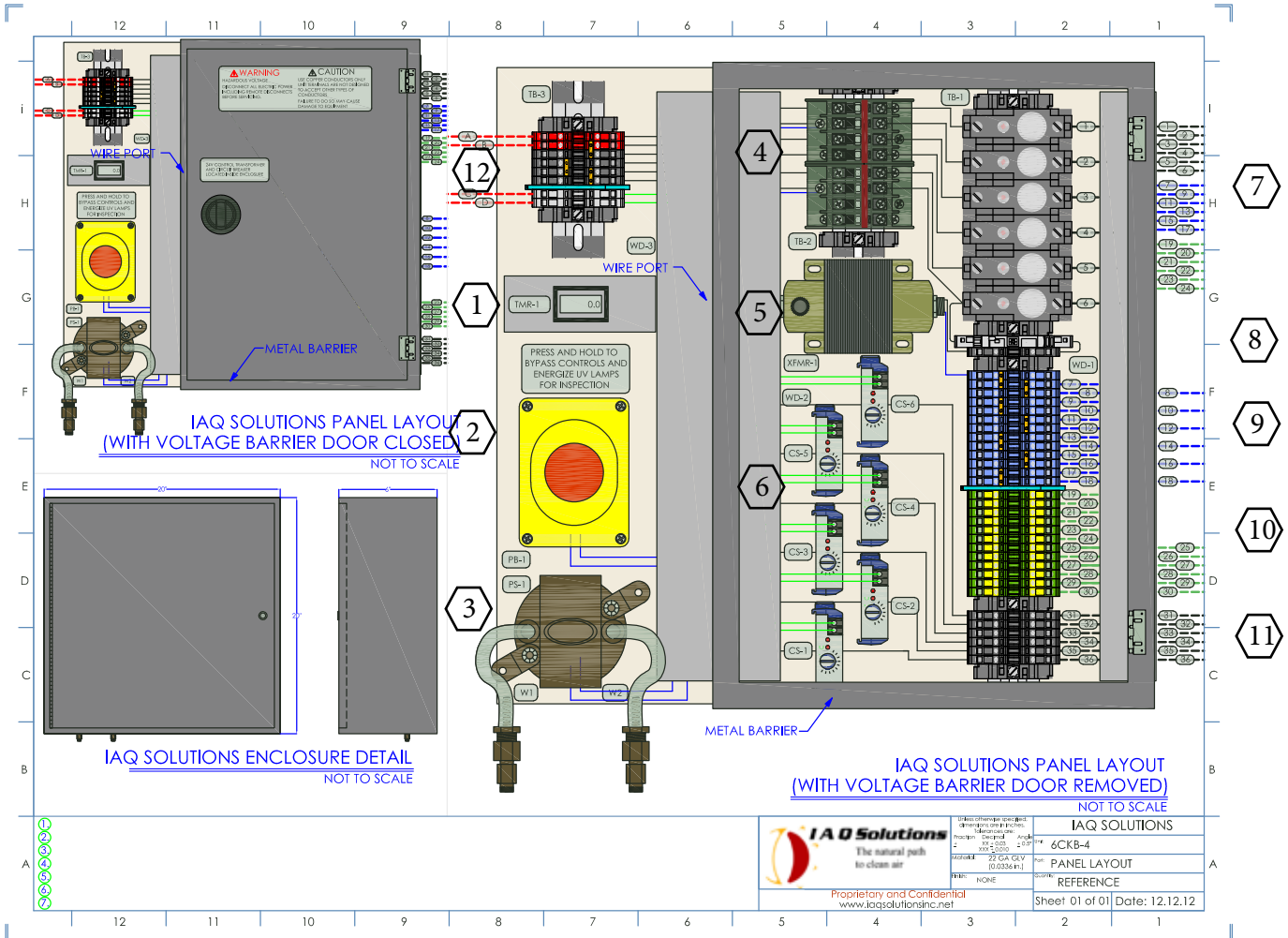

## Key

1. Timer
2. Safety Bypass/Momentary
3. Differential Pressure Switch
4. Lighting Contactor
5. Control Transformer
6. Amp Sensor
7. Line Fuse Holder
8. Transformer Fuse Holder
9. Neutral Buss Block
10. Ground Buss Block
11. Load Block
12. Terminal Block 3

# Ballast Troubleshooting Chart

Figure 1a

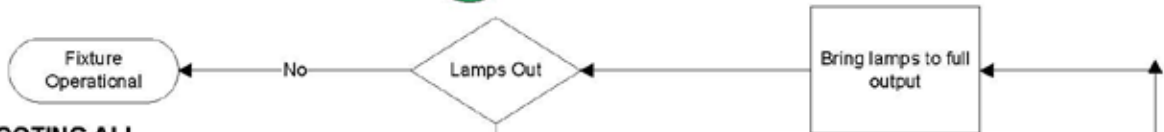

## TROUBLESHOOTING ALL FLUORESCENT FIXTURES

**SAFETY FIRST:** Voltage and current measurements present possibility of exposure to hazardous voltages and should be performed only by qualified personnel. Many troubleshooting techniques require measurement with input voltage applied requiring extra precautions to avoid electrical shock. Use proper safety equipment such as eye protection and gloves when performing electrical measurements.

### INOPERATIVE FIXTURE

Often a fixture becomes inoperative due to causes not attributable to the ballast. It is therefore important to examine all fixture components before removing the ballast for replacement. We recommend the following general procedures for both magnetic and electronic ballast:

1. Replace or check all lamps to ensure satisfactory operation.
2. As lamps are removed, examine all sockets to ensure they are not damaged or broken and are making proper and positive contact with the lamps.
3. Examine all electrical connections within the fixture, including at the lamp sockets, to ensure conformance with the wiring diagram on the ballast.

Figure 1a is a systematic approach for troubleshooting most problems that arise regarding fixtures using ballasts with startup protection. For those situations when these documents do not assist in correcting the problem, the manufacturer should be contacted to coordinate with the lamp and ballast manufacturers for further actions.

**NOTE:** Programmed Start Ballasts include lamp end-of-life circuitry. This circuit is included to maximize lamp life when one lamp fails in the circuit. The feature enables the ballast to detect when lamps fail and safely remove power from the lamps by going into a shutdown mode. The ballast also goes into a shutdown mode when it detects lamps not properly placed in the sockets. When troubleshooting the circuit, make sure to replace inoperative lamps or make sure lamps are placed properly in the sockets. Programmed Start ballasts also include a re-strike feature that will restart the lamps after the failed lamp has been replaced. Open circuit voltage cannot be measured due to lamp end-of-life circuitry.

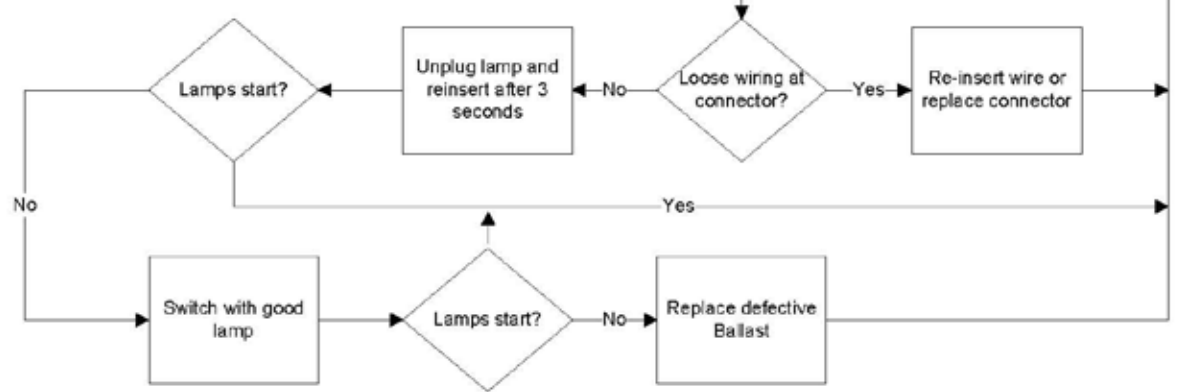
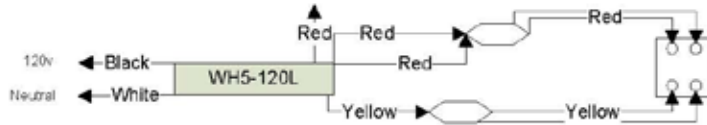

## General IAQ Solutions Spec Sheet

Document Revision Date: January 25, 2018

The following is a guide specification for the IAQ Solutions, Inc. PCP (Populated Catalyst Panel) Compound Product. This specification is not intended to be used without editing, as there are numerous choices throughout the document (enclosed in brackets “[ ]” & highlighted in blue) that require decisions to be made by the specifying design professional. GENESIS AIR, INC. IS NOT RESPONSIBLE FOR THE USE OF SUPERCEDED OR INACCURATE SPECIFICATIONS BY OTHERS. Designers are encouraged to check with their local Manufacturer’s Representative, or with Genesis Air, Inc., to ensure that the guidance documents being used are the latest revision.

### 1.0 PHOTOCATALYTIC OXIDATION (PCO) UNIT

PCO unit shall be factory-fabricated and tested two-part integral assembly for treatment of air by: (1) Ultraviolet Germicidal Irradiation (UVGI) using UVC lamps; and (2) Photocatalytic Oxidation using TiO<sub>2</sub> media. The assembly shall provide ultraviolet disinfection for bacteria, mold and odor control (including organic fuel exhaust fumes) inside the equipment it is installed in. The combination of UVC lamps and TiO<sub>2</sub> media is intended to create hydroxyl radicals at the surface of the media (Passive) and not to broadcast radicals into the occupied spaces (Active). The photocatalyst unit shall be complete with all miscellaneous accessories required to form a complete unit.

#### 1.1 Unit Casing

Casing shall be of single-wall construction, fabricated of [5052 aluminum] [24 gauge 304 stainless steel] [22 gauge galvanized steel]. All elements of the casing shall be free from sharp edges and burrs. Casing shall be 5.8” deep.

#### 1.2 Unit Capacity

The UV dosage shall be calculated for theoretical 99% air disinfection at air velocity and temperature and shall be adequate to deactivate microbial growth on all exposed surfaces within the irradiated profile. Unit shall be rated for a maximum velocity across the unit face of 500 feet per minute.

#### 1.3 PCO Media

Media shall consist of six-inch (nominal) non-metallic media with face area to match casing opening, pleated at one pleat per inch (nominal), with a minimum 8000 nanometer TiO<sub>2</sub> coating. PCO media shall be placed perpendicular to the air stream in the unit casing. Media shall have an internal mechanism to eliminate the silica produced by the oxidation of ethanol.

#### 1.4 UVGI Lamps & Ballasts

Lamps and ballasts shall be designed specifically to provide type-C ultraviolet light with a wavelength at or near 2537 Angstroms. Lamps shall be non-ozone-producing. Lamps shall be Teflon-coated to reduce breakage. Sufficient lamps shall be provided and positioned center point through the media equidistant from edges so as to achieve a minimum coverage of 9.5 milliwatts per square inch of UVC light, upstream and downstream, across all exposed surfaces of the PCO media. Lamp UVC output shall not drop below 9.5 milliwatts per square inch over their usable 12000 hr life.

## 1.5 Electrical

Unit shall be configured to operate with 120V/1 $\phi$ /60Hz electrical power. Unit shall be provided with a control box for points of connection.

## 1.6 UL Certification

The entire PCP assembly shall bear the UL Classification Mark and be investigated in accordance with ANSI/UL 1598, "Luminaires," and ANSI/UL 1995, "Heating and Cooling Equipment," under the Air Duct Mounted Accessories category (ABQK). Manufacturers UL file number shall be permanently marked on the exterior of the product. Compliance is to be verified by the UL Online Certifications Directory.

## 1.7 Racking System and OSHPD Certification

The racking system shall be constructed of galvanized sheet metal as either a face-loading or side-loading design. Either system must show proof of conformance to [ICB 2012 and CBC 2010.] [ICB 2012, CBC 2010 and ICC AC-156 (2010). The catalyst, accessory panel and the racking system shall bear the OSP certification number.]

## 1.8 Safety

The assembly shall employ safety interlock switches, which interrupts power when the housing is opened for servicing. Safety limit switches and Exterior SPST On/Off switches shall be pre-wired and factory installed in a weatherproof junction box. The product employs germicidal lamps, which emit UV-C radiation, thereby posing a potential risk of exposure to eyes and bare skin during maintenance. [Air Handler access doors shall have a glass visual examination port as provided by equipment manufacturer.] Warning signage provided by UV equipment manufacturer shall be permanently mounted on each access with direct line of sight to the lamps with UL requirements as to safety aspects.

## 1.9 Performance

The manufacturer must provide independent third party testing to prove its claims. At a minimum, the results shall demonstrate:

- a. First pass efficiencies only. Manufacturers with chamber tests only shall be excluded.
- b. VOC reduction at odor threshold concentrations or greater.
- c. NO reduction of 40% minimum at odor threshold concentrations or greater.
- d. All manufacturers using carbon to influence the test results shall be excluded.

Manufacturer: IAQ Solutions, Inc.  
Model No.: [XXXX] [E] PCP Compound  
Manufacturer's Website: [www.iaqsolutionsinc.net](http://www.iaqsolutionsinc.net)

## LIMITED WARRANTY

### ***FAILURE TO MAINTAIN YOUR EQUIPMENT WILL VOID THIS WARRANTY***

Your **IAQ SOLUTIONS™** purification system is expressly warranted from the date of installation to be free from manufacturing defects for the coverage period stated below. Defective parts must be returned no later than thirty (30) days after the failure by you to the installing contractor together with the **IAQ SOLUTIONS™** purification system's model number, serial number, and documented installation date of the **IAQ SOLUTIONS™** purification system.

#### **ONE (1) YEAR COVERAGE -- RESIDENTIAL AND COMMERCIAL APPLICATIONS**

The covered equipment and covered components are warranted by **IAQ SOLUTIONS** for a period of ONE (1) year from the date of the original unit installation, when installed in a residential or commercial application. If during this period, a covered component fails because of a manufacturing defect, **IAQ SOLUTIONS** will provide a free replacement part. You must pay shipping charges and all other costs of warranty service. **IAQ SOLUTIONS** will not pay labor involved in diagnostic calls or in removing, repairing, servicing or replacing parts. Such costs may be covered by a separate warranty provided by the installer. NOTE - If the date of original installation cannot be verified, the warranty period will be deemed to begin six (6) months after the date of manufacture.

#### **EXCLUDED COMPONENTS**

The following components are not covered by this warranty: the UVCGI lamps or the pleated photo catalytic material. These are replacement items, which must be replaced as stated in the Maintenance section of the installation instructions to ensure effective operation.

#### **REPAIRS**

All repairs of covered components must be made with authorized service parts by a qualified service dealer or contractor. Labor charges are not covered by this warranty.

#### **WARRANTY LIMITATIONS**

This warranty will be voided if the covered equipment is removed from the original installation site. This warranty does not cover damage or defect resulting from:

- 1 - Flood, wind, fire, lightning, or installation and operation in a corrosive atmosphere (chlorine, fluorine, salt, recycled waste water, urine, fertilizers, or other damaging chemicals).
- 2 - Accident, or neglect or unreasonable use or operation of the equipment, including operation of electrical equipment at voltages other than the range specified on the unit nameplate (includes damages caused by brownouts).
- 3 - Modification, change or alteration of the equipment, except as directed by IAQ Solutions.
- 4 - Operation with system components (indoor unit and control devices), which do not match, or meet the specifications recommended by IAQ Solutions.
- 5 - Operation with system components (indoor unit and control devices), which exceed operational temperature range of: -20 F to 122F.
- 6 - Warning: The panels are self cleaning when lamps are on and replaced every 16 months. Failure to replace lamps within 16 months or power lamps after install on an operational unit will void all panel warranties.**

THIS WARRANTY SHALL NOT OBLIGATE THE MANUFACTURER FOR ANY LABOR COSTS AND SHALL NOT APPLY TO DEFECTS IN WORKMANSHIP OR MATERIALS FURNISHED BY THE INSTALLING CONTRACTOR AS CONTRASTED TO DEFECTS IN THE IAQ SOLUTIONS™ PURIFICATION SYSTEM ITSELF. IMPLIED WARRANTIES OF MERCHANTABILITY OR FITNESS FOR A PARTICULAR PURPOSE SHALL BE LIMITED IN DURATION TO THE AFORESAID COVERAGE PERIOD. THE MANUFACTURER'S LIABILITY FOR INCIDENTAL OR CONSEQUENTIAL DAMAGES, OTHER THAN DAMAGES FOR PERSONAL INJURIES, RESULTING FROM ANY BREACH OF THE AFORESAID IMPLIED WARRANTIES OR THE ABOVE LIMITED WARRANTY IS EXPRESSLY EXCLUDED. THIS LIMITED WARRANTY IS VOID IF DEFECT(S) RESULT FROM FAILURE TO HAVE THIS UNIT INSTALLED BY A QUALIFIED HEATING AND AIR CONDITIONING CONTRACTOR. IF THE LIMITED WARRANTY IS VOID DUE TO FAILURE TO USE A QUALIFIED CONTRACTOR, ALL DISCLAIMERS OF IMPLIED WARRANTIES SHALL BE EFFECTIVE UPON INSTALLATION.

Some states do not allow limitations on how long an implied warranty lasts or the exclusion or limitation of incidental or consequential damages, so the above exclusion or limitations may not apply to you. This warranty gives you specific legal rights and you may also have other rights, which vary from state to state.

**To register your new IAQ SOLUTIONS™ Purification System, PLEASE CUT ON DOTTED LINE AND RETURN THE REGISTRATION FORM TO THE ADDRESS NOTED BELOW.**

Customer Name: Address: \_\_\_\_\_  
City: State/Province: Zip/Postal Code: \_\_\_\_\_  
Home Phone: E-mail: \_\_\_\_\_  
Installing Contractor: Phone: \_\_\_\_\_  
Date of installation: Model Number: \_\_\_\_\_ Serial Number: \_\_\_\_\_



Please send this completed form to: IAQ SOLUTIONS™  
**IAQ SOLUTIONS, INC.**