



TECH LIGHTING
2018 GALLERY PROGRAM

MAY 21, 2018

O V E R V I E W

TECH LIGHTING is excited to present its Gallery Showroom Program to strengthen our partnership with top showrooms and provide an industry-leading, dynamic shopping experience for customers.

Providing our showroom leaders with the opportunity to fully harness Tech Lighting merchandising, marketing, and product knowledge, our objective is to provide an unsurpassed brand experience designed to grow showrooms sales and profitability with a simple, straightforward program and process.

Each Tech Lighting Gallery will be uniquely curated with on trend, impactful product to best serve each showroom's individual market.



SKOKIE SOWROOM

The Tech Lighting Gallery Showroom Program creates an elegant, contemporary product presentation intended to maximize sales and appropriately present the Tech Lighting brand and products.

Benefits of participation in the Gallery Showroom Program:

- Priority differentiation as a Gallery Showroom on the Tech Lighting website Showroom Locator
- Exclusive Gallery Showroom Growth Rebates
- Exclusive Rewards/Promotions for Gallery Showroom Sales Associates
- Extended discounts on standard display product promotions

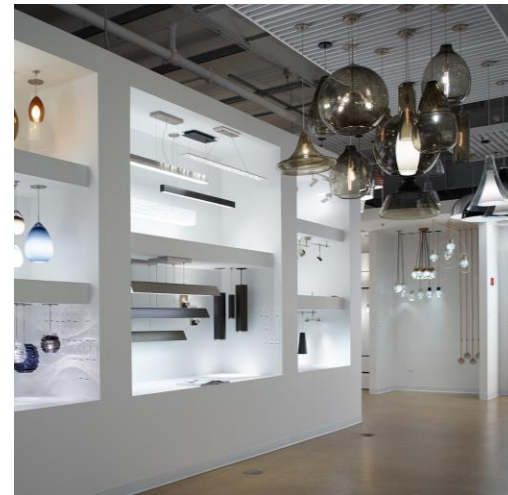



GALLERY PROGRAM OVERVIEW

DETAILS

Display Requirement

Minimum 20 linear-foot Gallery Display with ceiling cloud displays (per standard Gallery display program). Must be continuous linear footage.

Display Product Discount/Terms

Gallery product orders receive a 50% discount on standard DN pricing and qualify for 30-60-90 Dating & Full Freight Allowance within the continental United States.

Display Reimbursement Allowance

Gallery Materials/Labor Reimbursement Allowance of \$100/linear ft. will be issued to customers who have met all Gallery Program requirements (paid after display installation and confirmation of compliance).

Gallery Program Growth Rebate

Showrooms that meet all of the criteria of the Tech Lighting Gallery Showroom Program (during consecutive calendar years) are eligible for Gallery Showroom Year-Over-Year Growth Rebates.

- 10%-14.99% year-over-year growth earns a 2% rebate on net invoiced product orders
- 15%+ year-over-year growth earns a 3% rebate on net invoiced product orders

Rebate calculation begins in year the Gallery Display is installed. Rebates are paid in year following the year earned (with finalization of Tech Lighting fiscal close). Gallery terms will be reassessed annually.



P R O C E S S

Participants agree to comply with the following processes and rules:

- Photographs & measurements of proposed gallery space must be submitted to Tech Lighting
- Declare and submit target installation date
- Submit current on-display, on-hand & on-order inventory. Display product swap-out TBD per showroom.
- Review & refine Gallery proposal with Merchandising Team
- Present formal Gallery proposal to customer for approval
- Upon approval, submit purchase order to Merchandising Team, marked GALLERY ORDER, with required ship date
- Gallery must be maintained exclusively with current Tech Lighting product & signage for compliance
- Gallery must be updated annually to comply with new product Gallery Showroom Program requirements
- Products are not to be sold off of display
- Submit photos of completed Gallery to Merchandising Team for Gallery Reimbursement Allowance Approval

MERCHANDISING TEAM
7400 Linder. Skokie, IL 60077
T 847.410.4400
F 847.410.4500
merchandising@techlighting.com





GALLERY

FRAMED WALL

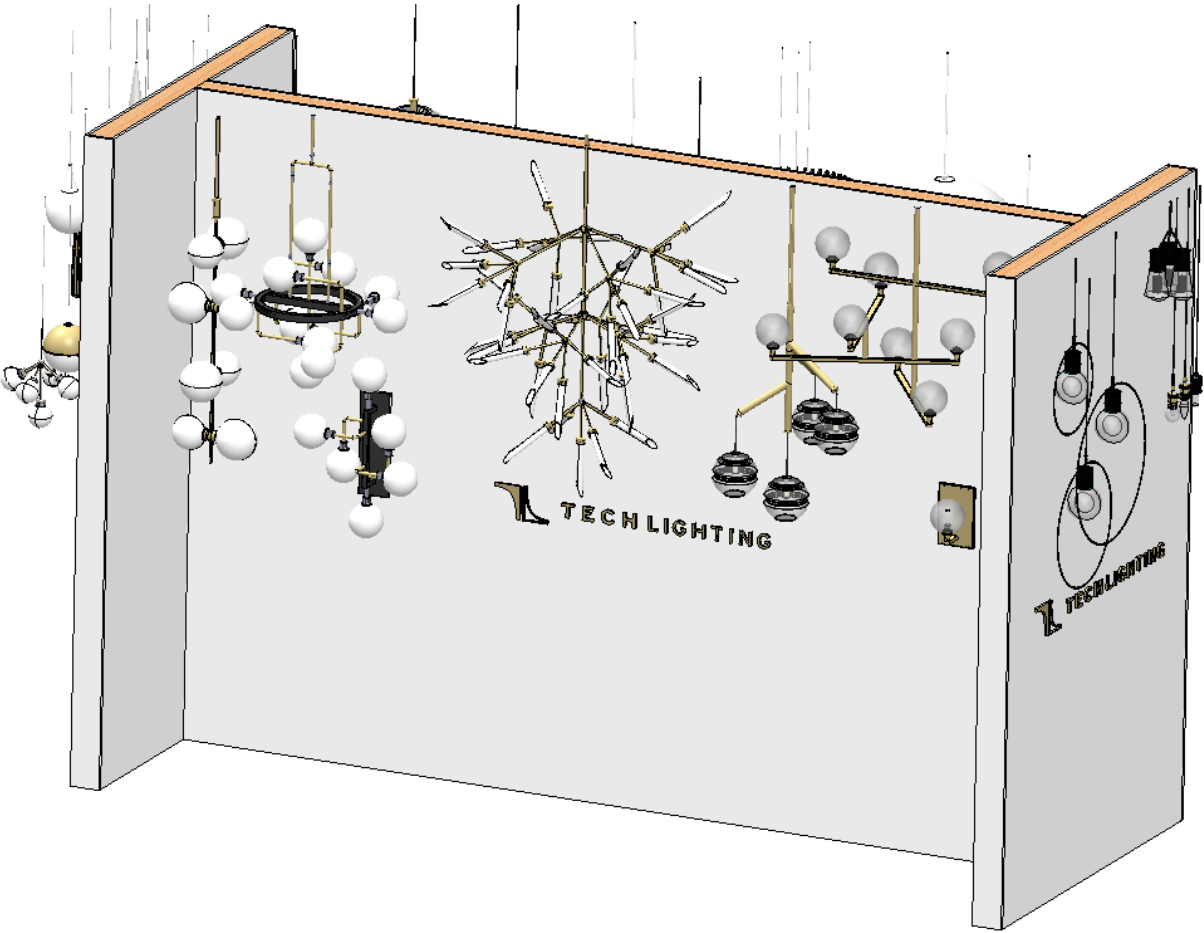

FRAMED WALL

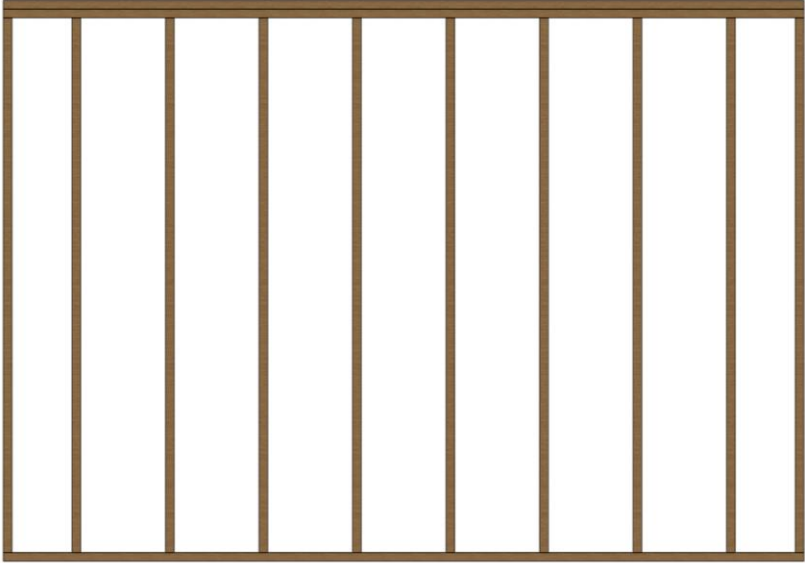
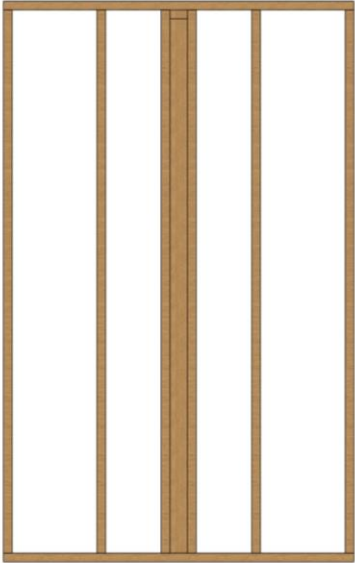

DRYWALL



DESIGNATED AREA FOR GALLERY DISPLAY

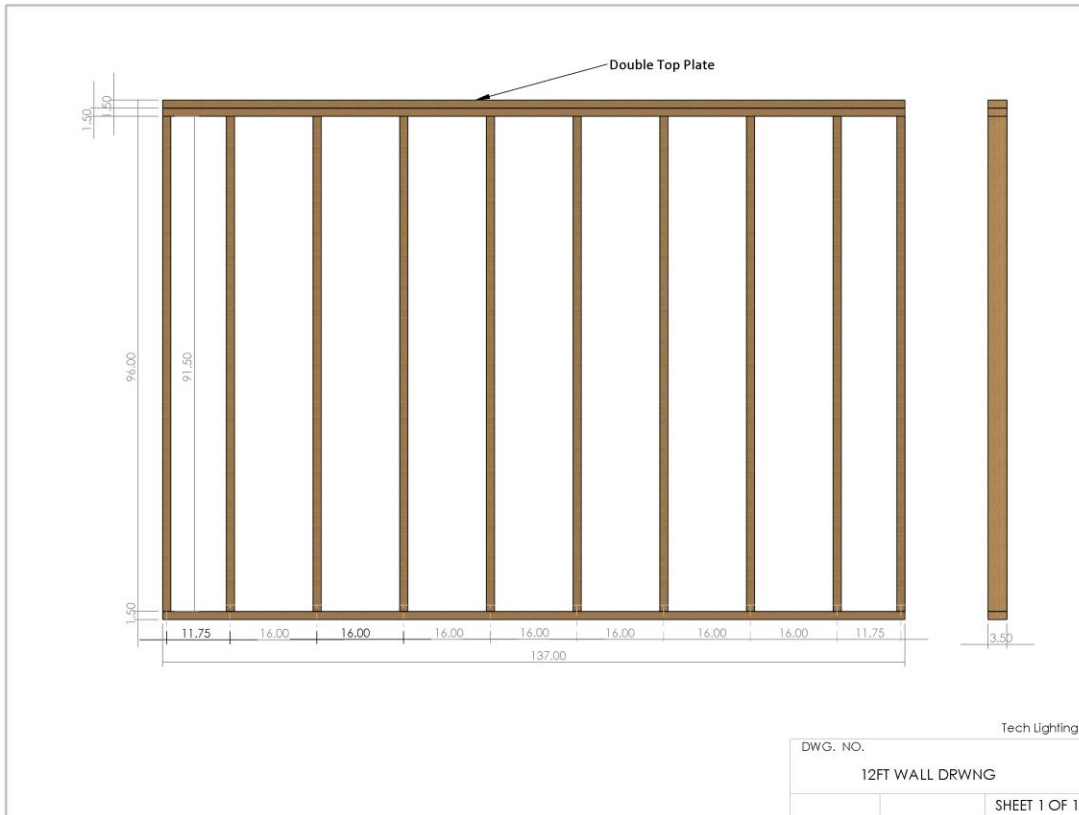

THE INFORMATION CONTAINED IN THIS DRAWING IS THE SOLE PROPERTY OF GENERATION LIGHTING. ANY REPRODUCTION IN PART OR AS A WHOLE WITHOUT THE WRITTEN PERMISSION OF GENERATION LIGHTING IS PROHIBITED.

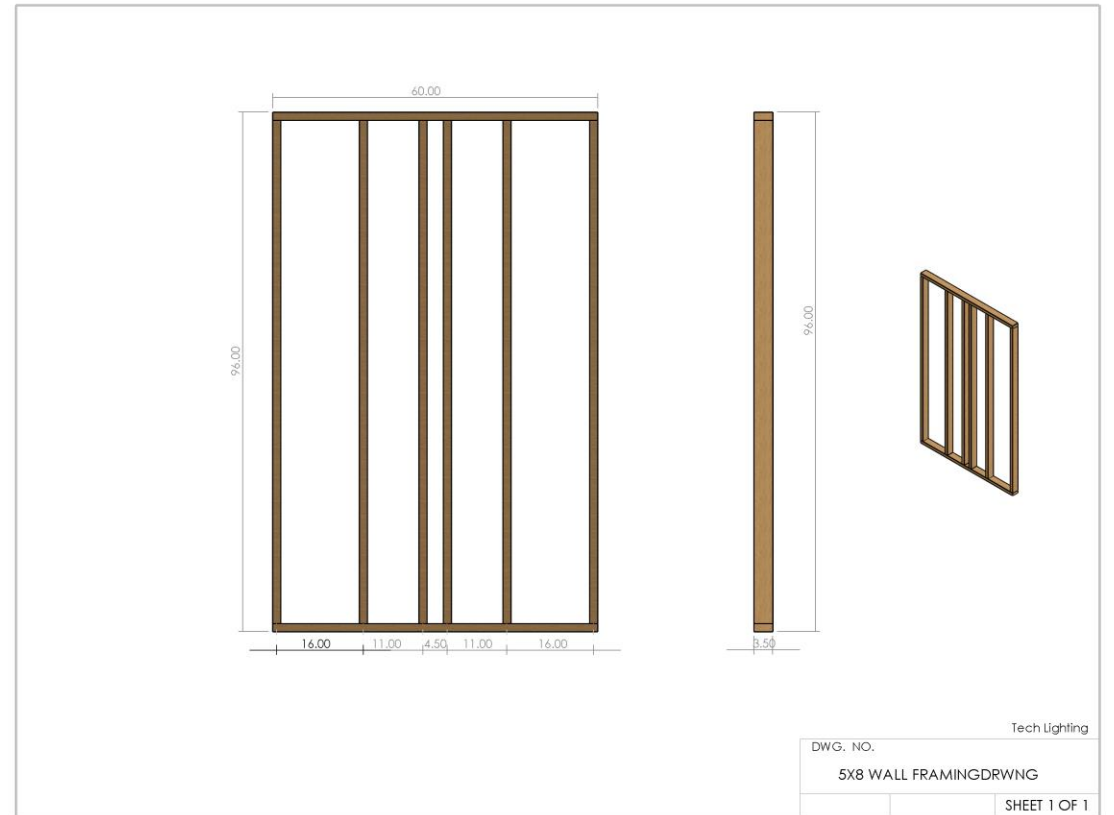

THE INFORMATION CONTAINED IN THIS DRAWING IS THE SOLE PROPERTY OF GENERATION LIGHTING. ANY REPRODUCTION IN PART OR AS A WHOLE WITHOUT THE WRITTEN PERMISSION OF GENERATION LIGHTING IS PROHIBITED.



BUILT WALL WITH LOGO INSTALLED

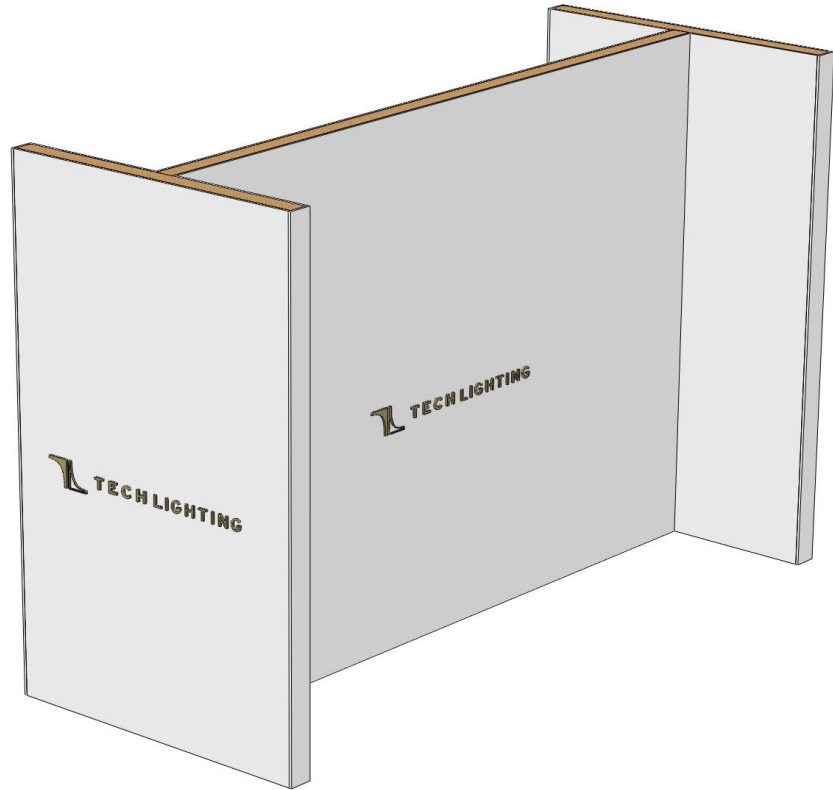

LOGO PLACEMENT

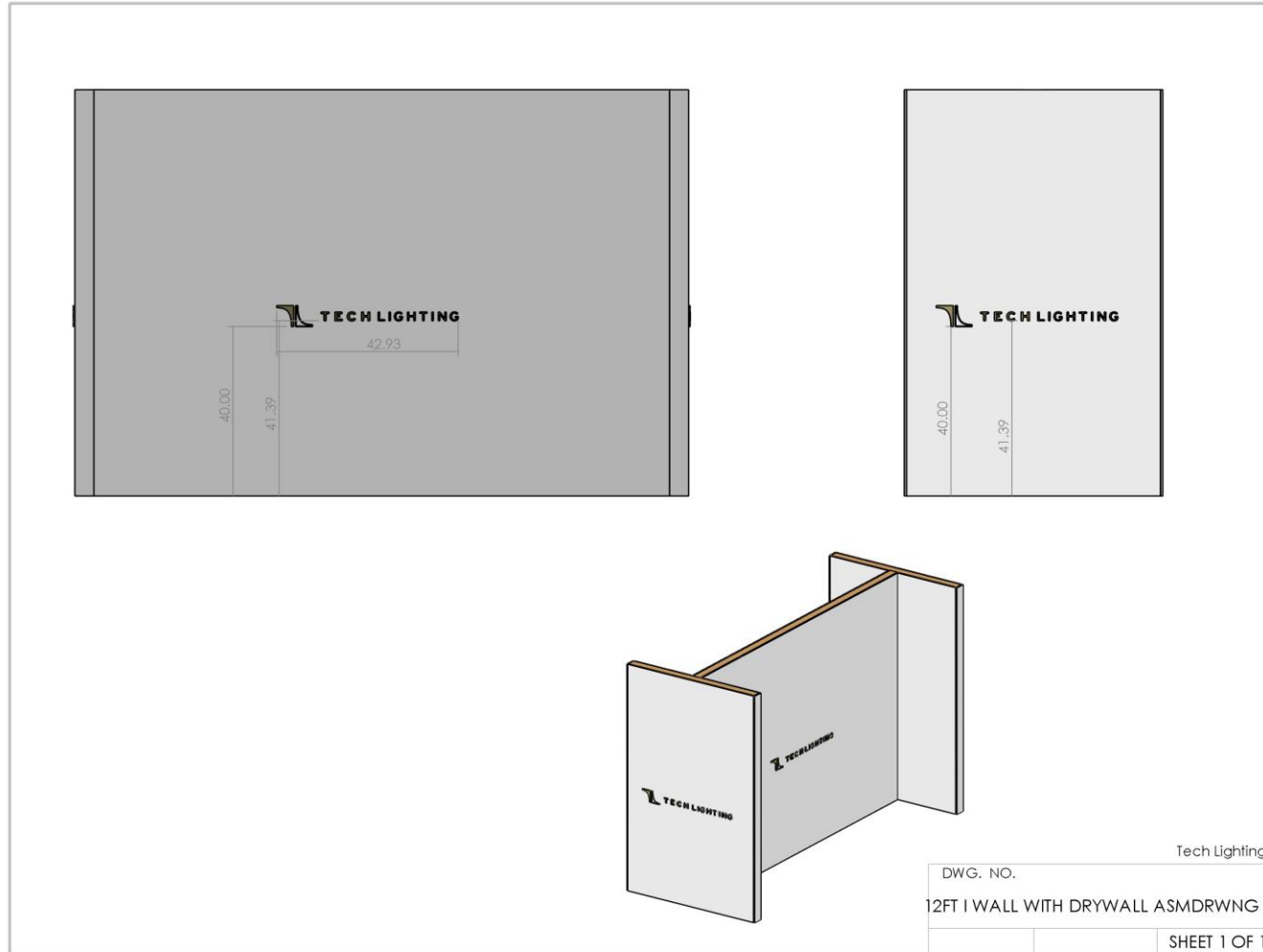

THE INFORMATION CONTAINED IN THIS DRAWING IS THE SOLE PROPERTY OF GENERATION LIGHTING. ANY REPRODUCTION IN PART OR AS A WHOLE WITHOUT THE WRITTEN PERMISSION OF GENERATION LIGHTING IS PROHIBITED.



CHANDELIER LAYOUT

INSTALL ON PRE-EXISTING SLOT GRID CLOUD

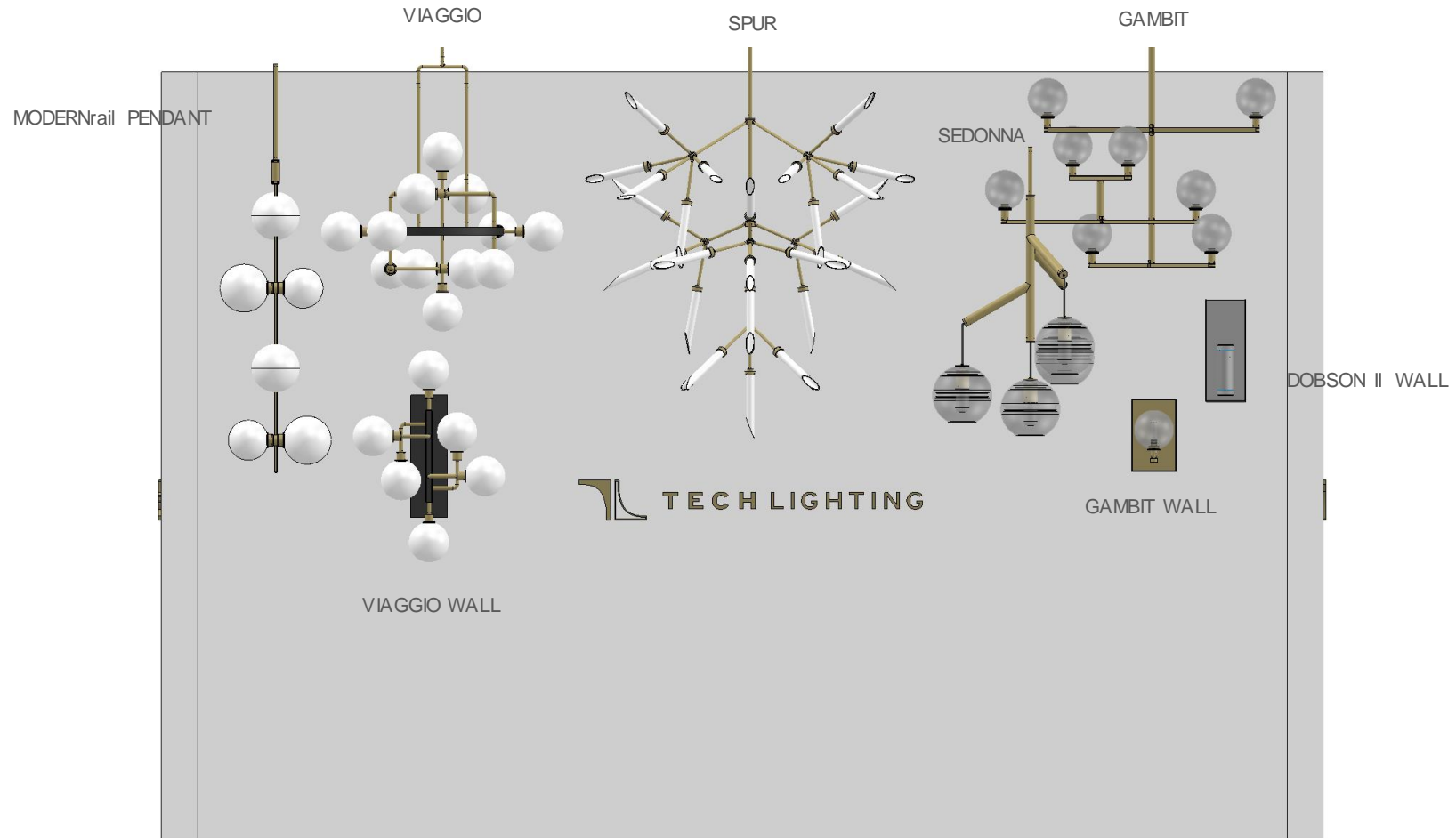

PENDANT LAYOUT

INSTALL ON PRE-EXISTING SLOT GRID CLOUD

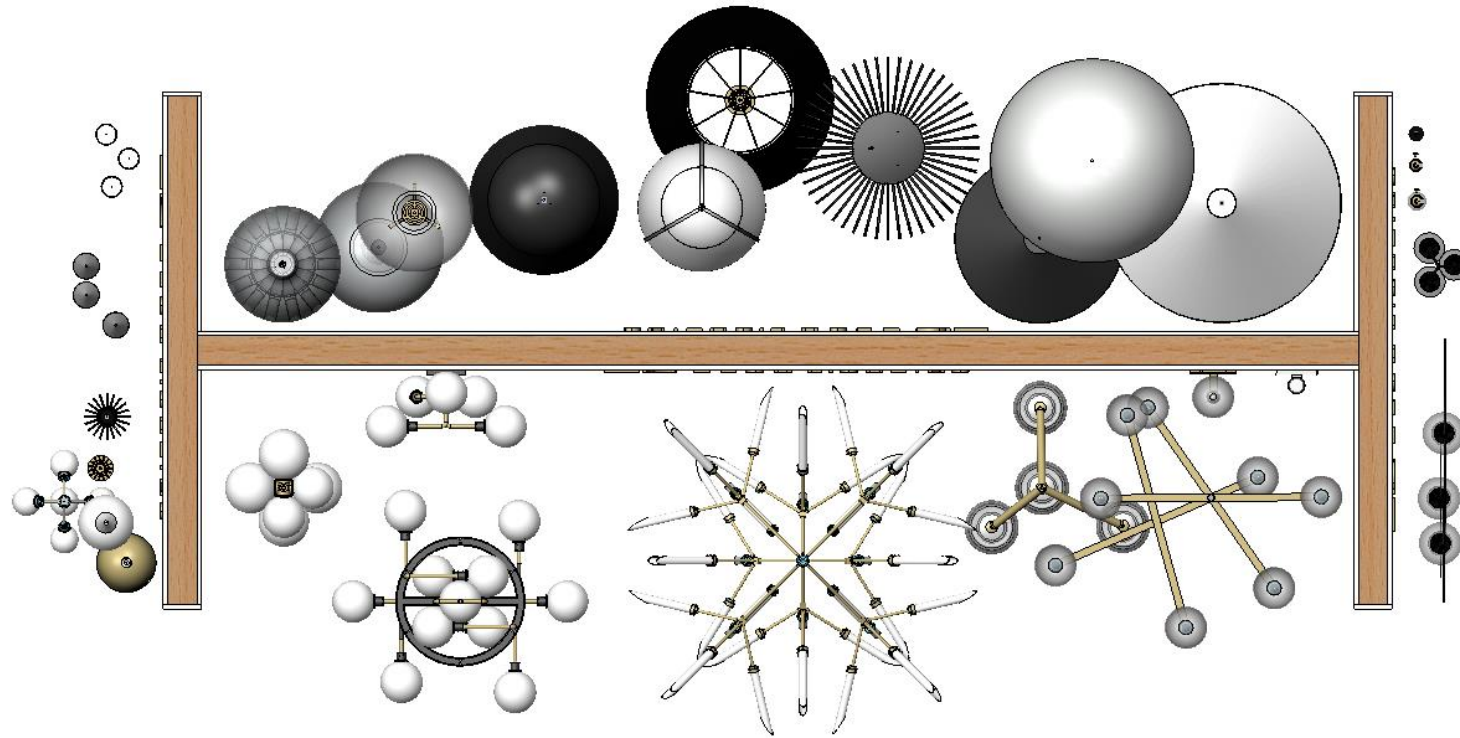

PENDANT LAYOUT

INSTALL ON PRE-EXISTING SLOT GRID CLOUD

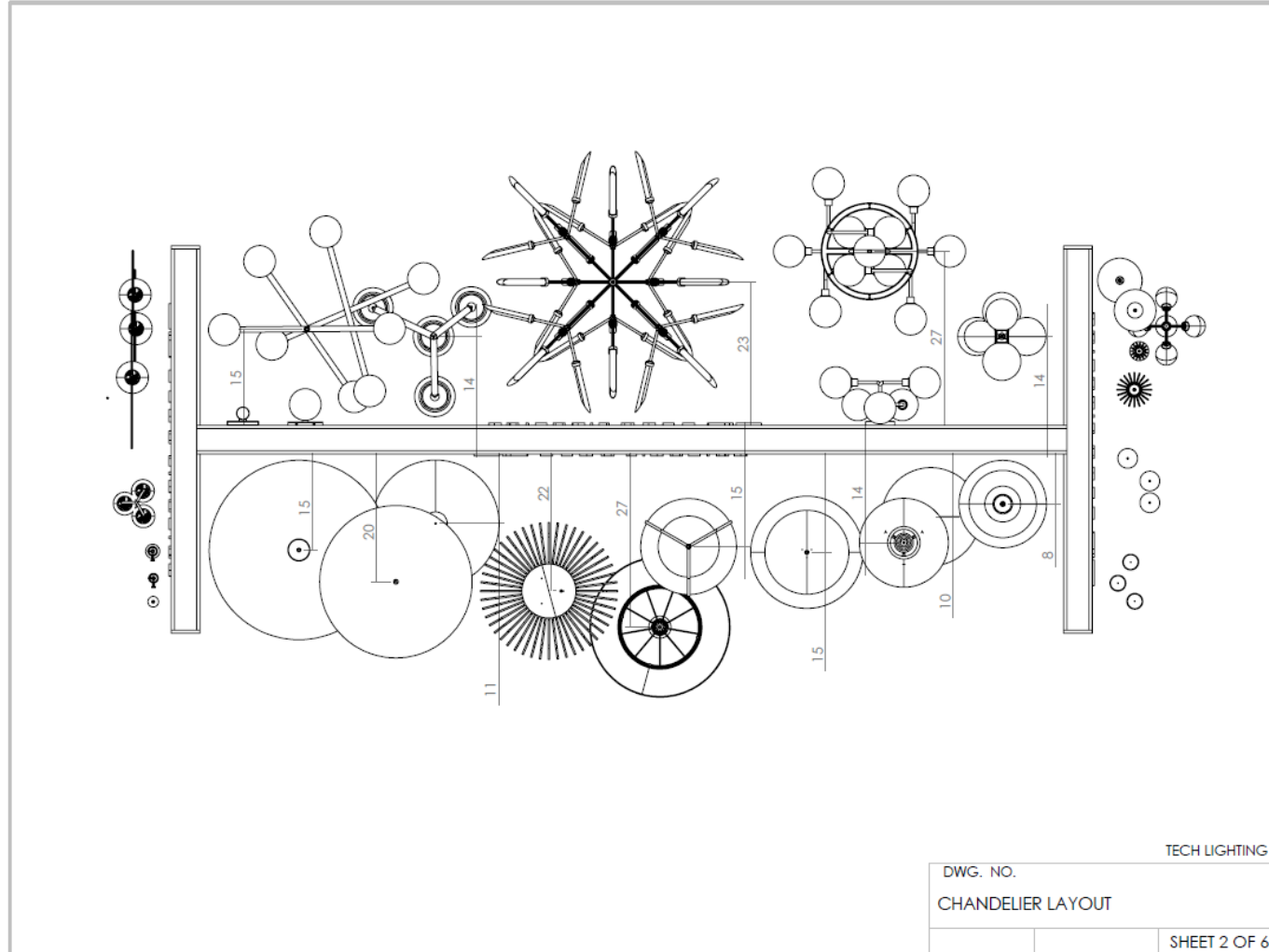

THE INFORMATION CONTAINED IN THIS DRAWING IS THE SOLE PROPERTY OF GENERATION LIGHTING. ANY REPRODUCTION IN PART OR AS A WHOLE WITHOUT THE WRITTEN PERMISSION OF GENERATION LIGHTING IS PROHIBITED.



CHANDELIER LAYOUT

INSTALL ON PRE-EXISTING SLOT GRID CLOUD

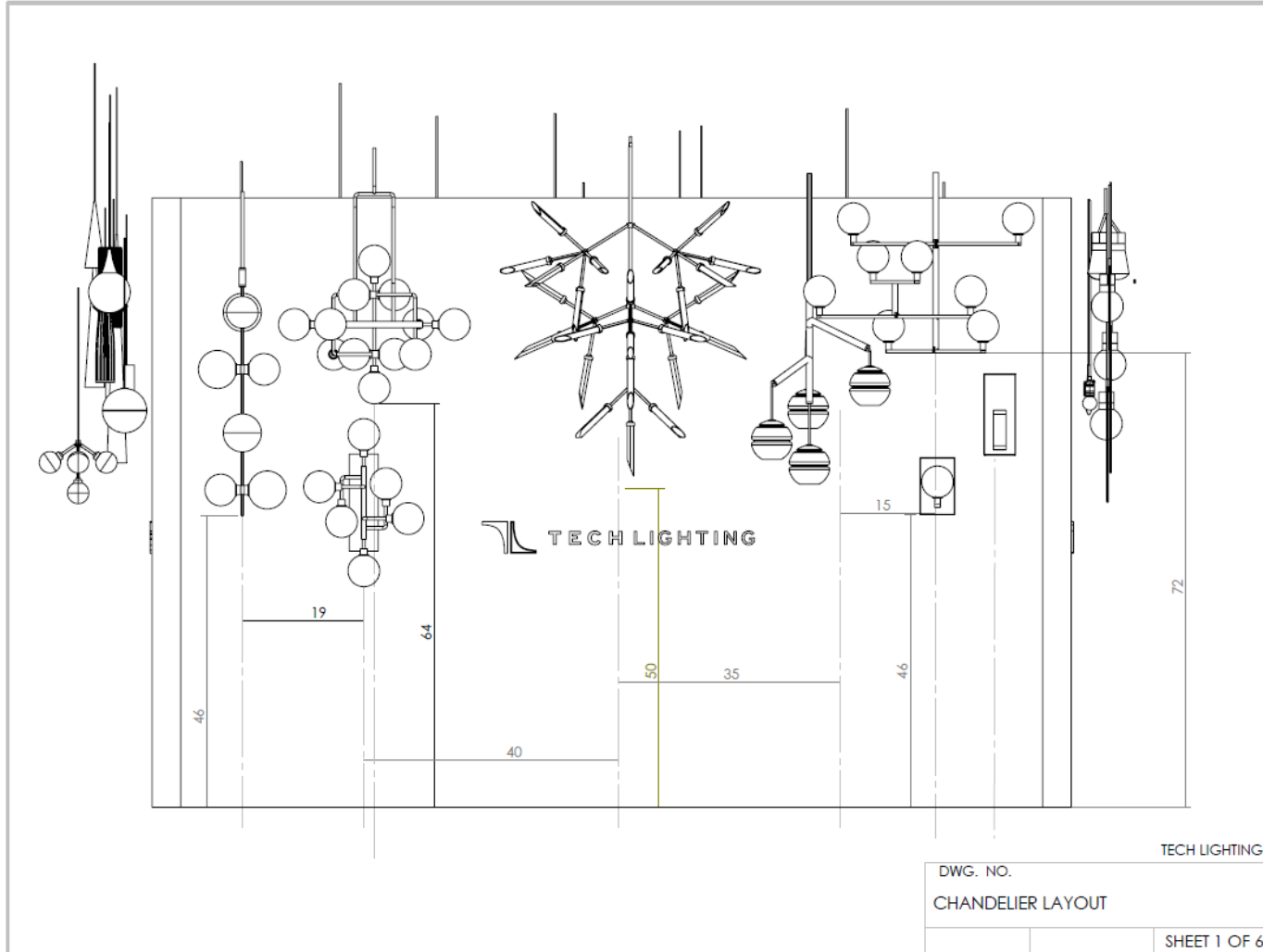

THE INFORMATION CONTAINED IN THIS DRAWING IS THE SOLE PROPERTY OF GENERATION LIGHTING. ANY REPRODUCTION IN PART OR AS A WHOLE WITHOUT THE WRITTEN PERMISSION OF GENERATION LIGHTING IS PROHIBITED.



CHANDELIER LAYOUT

INSTALL ON PRE-EXISTING SLOT GRID CLOUD

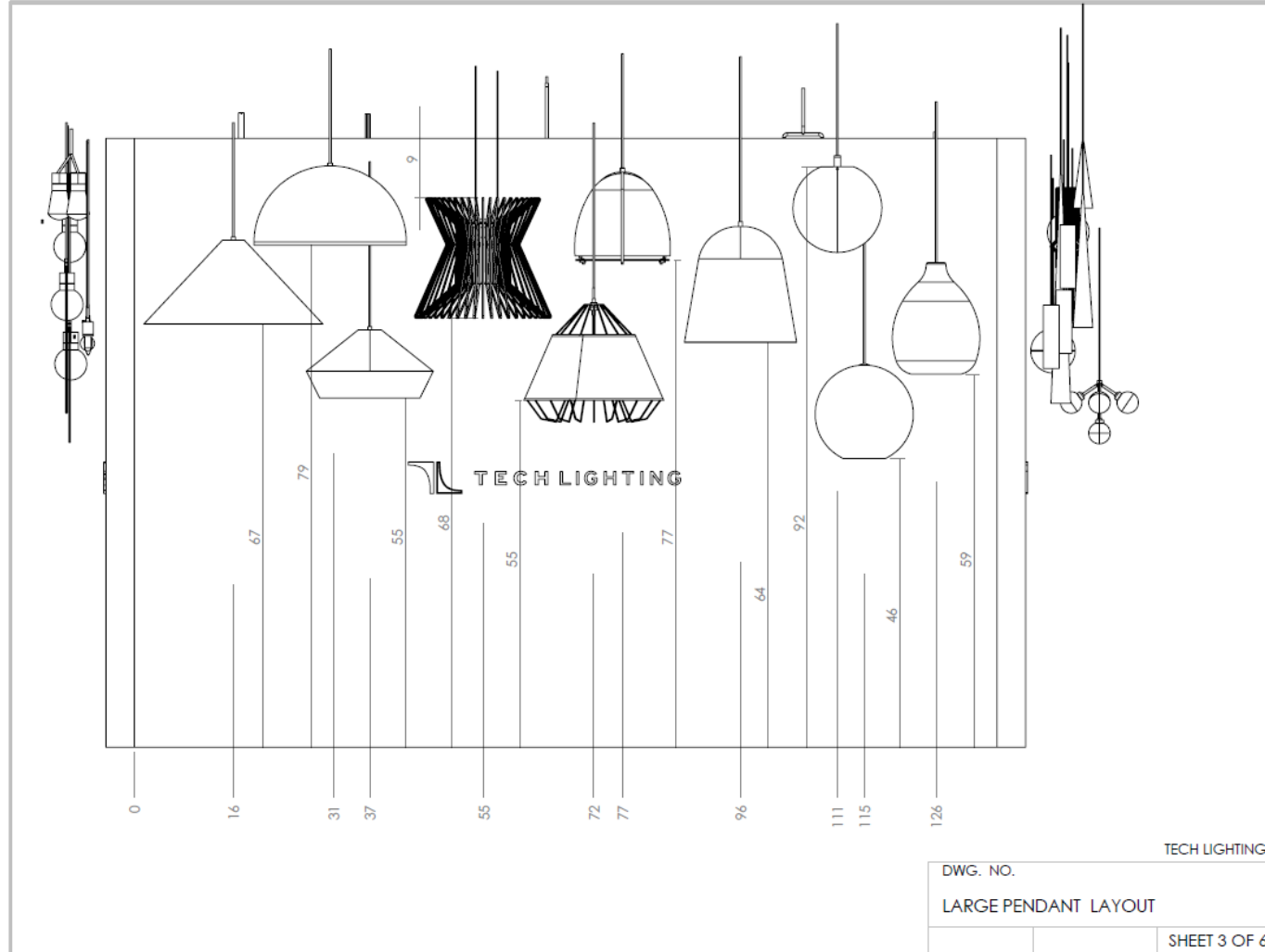

THE INFORMATION CONTAINED IN THIS DRAWING IS THE SOLE PROPERTY OF GENERATION LIGHTING. ANY REPRODUCTION IN PART OR AS A WHOLE WITHOUT THE WRITTEN PERMISSION OF GENERATION LIGHTING IS PROHIBITED.



CHANDELIER LAYOUT

INSTALL ON PRE-EXISTING SLOT GRID CLOUD

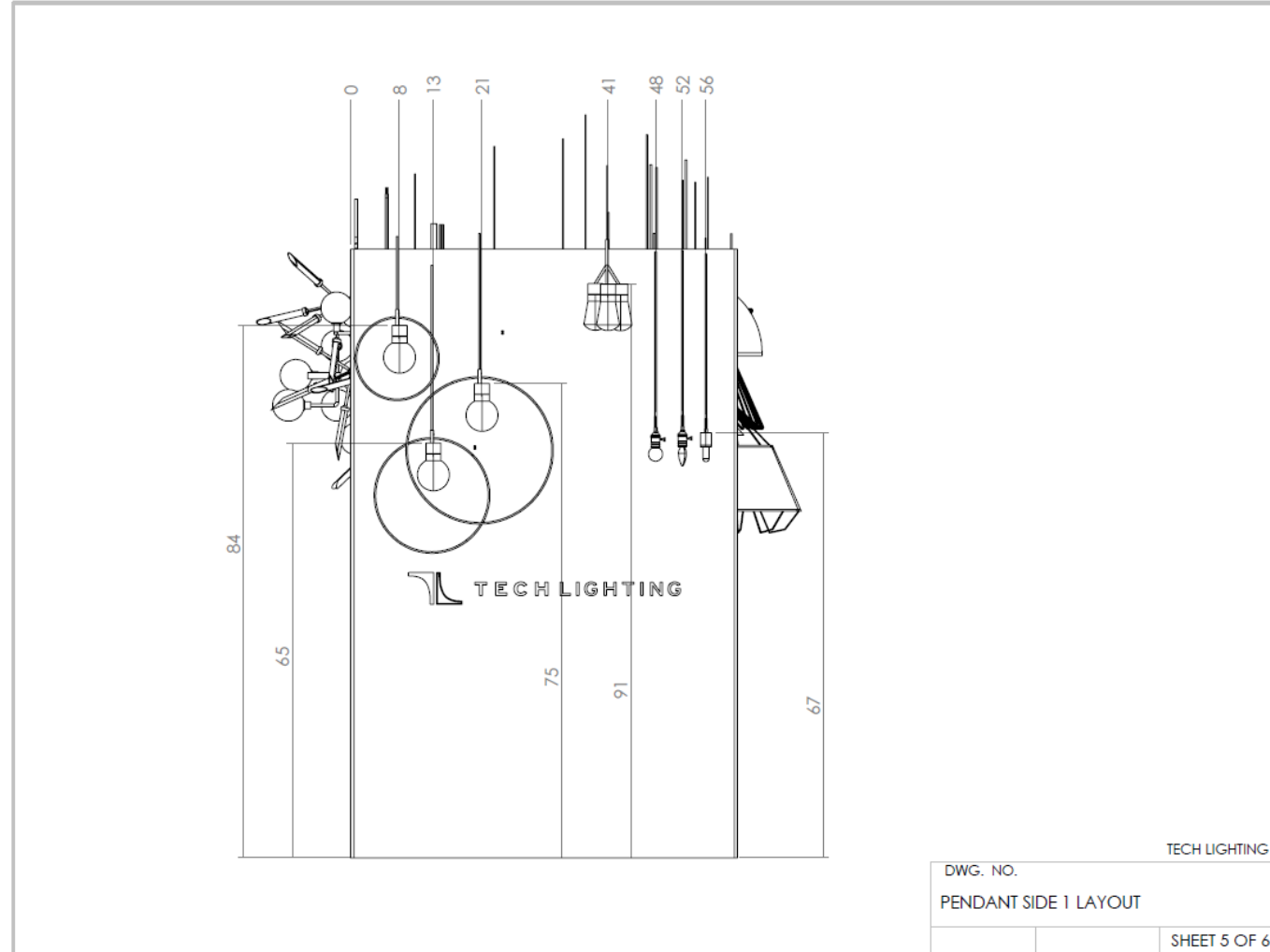

THE INFORMATION CONTAINED IN THIS DRAWING IS THE SOLE PROPERTY OF GENERATION LIGHTING. ANY REPRODUCTION IN PART OR AS A WHOLE WITHOUT THE WRITTEN PERMISSION OF GENERATION LIGHTING IS PROHIBITED.



CHANDELIER LAYOUT

INSTALL ON PRE-EXISTING SLOT GRID CLOUD

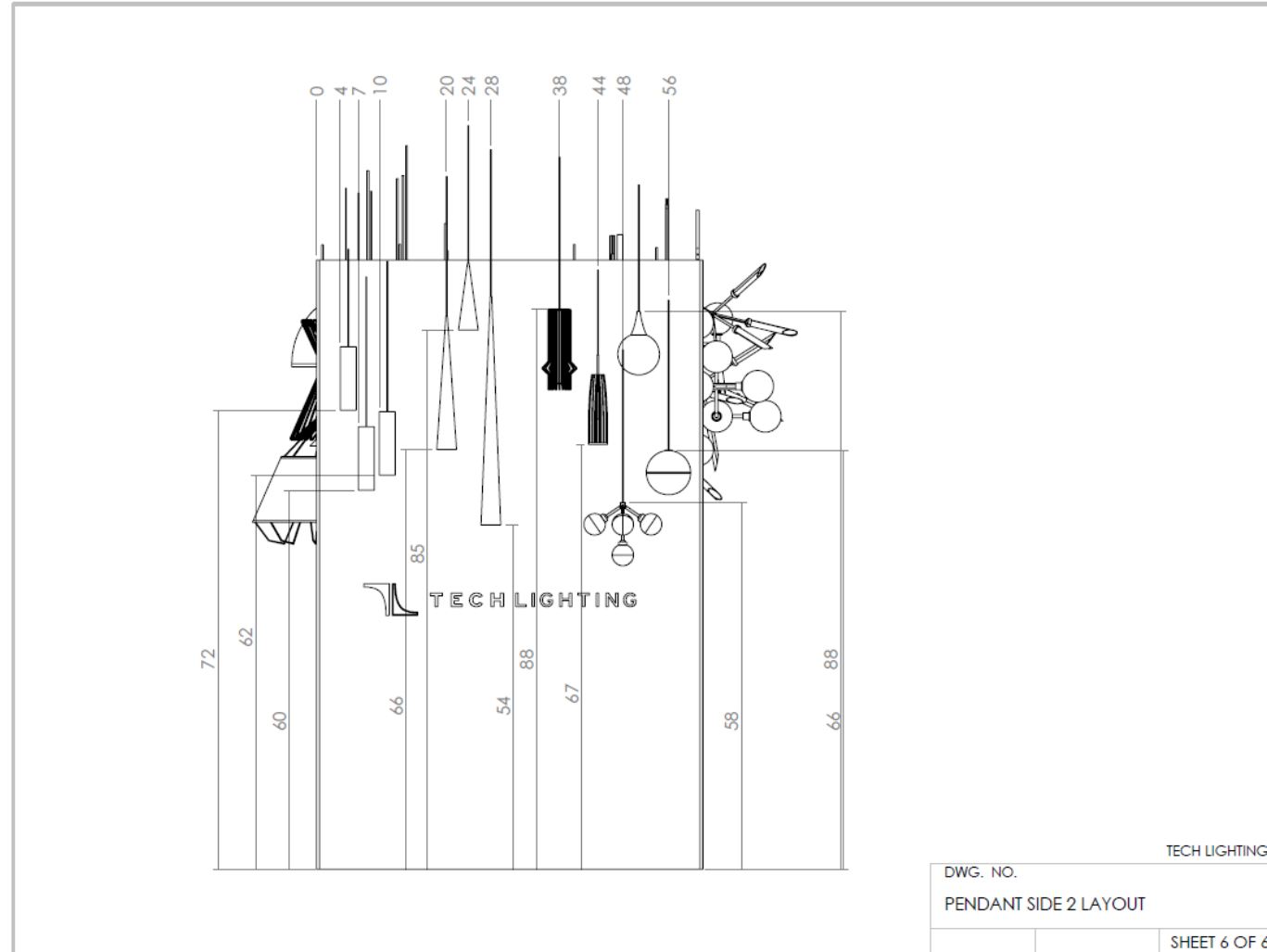

THE INFORMATION CONTAINED IN THIS DRAWING IS THE SOLE PROPERTY OF GENERATION LIGHTING. ANY REPRODUCTION IN PART OR AS A WHOLE WITHOUT THE WRITTEN PERMISSION OF GENERATION LIGHTING IS PROHIBITED.



FLOOR PLAN

Decorative Niche

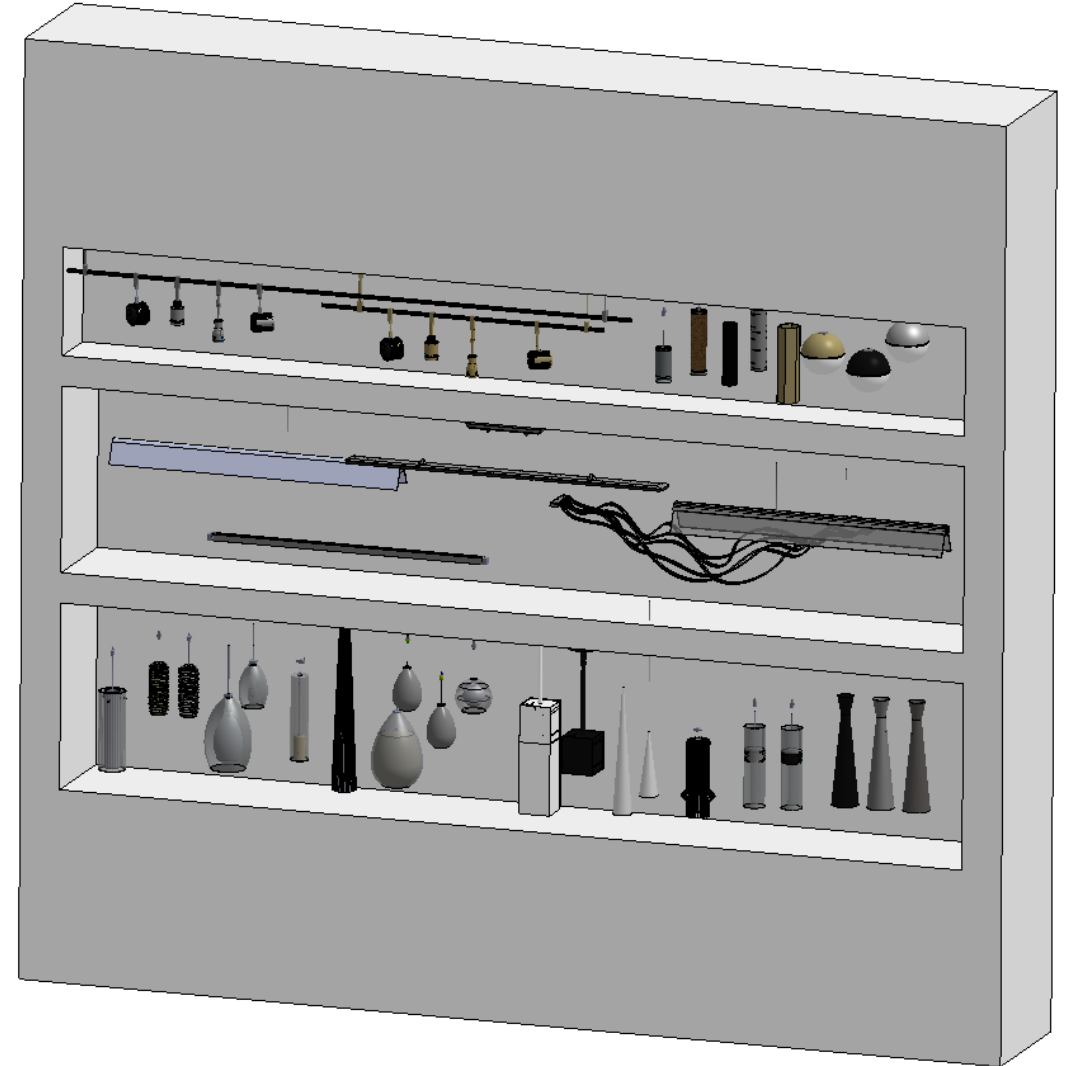
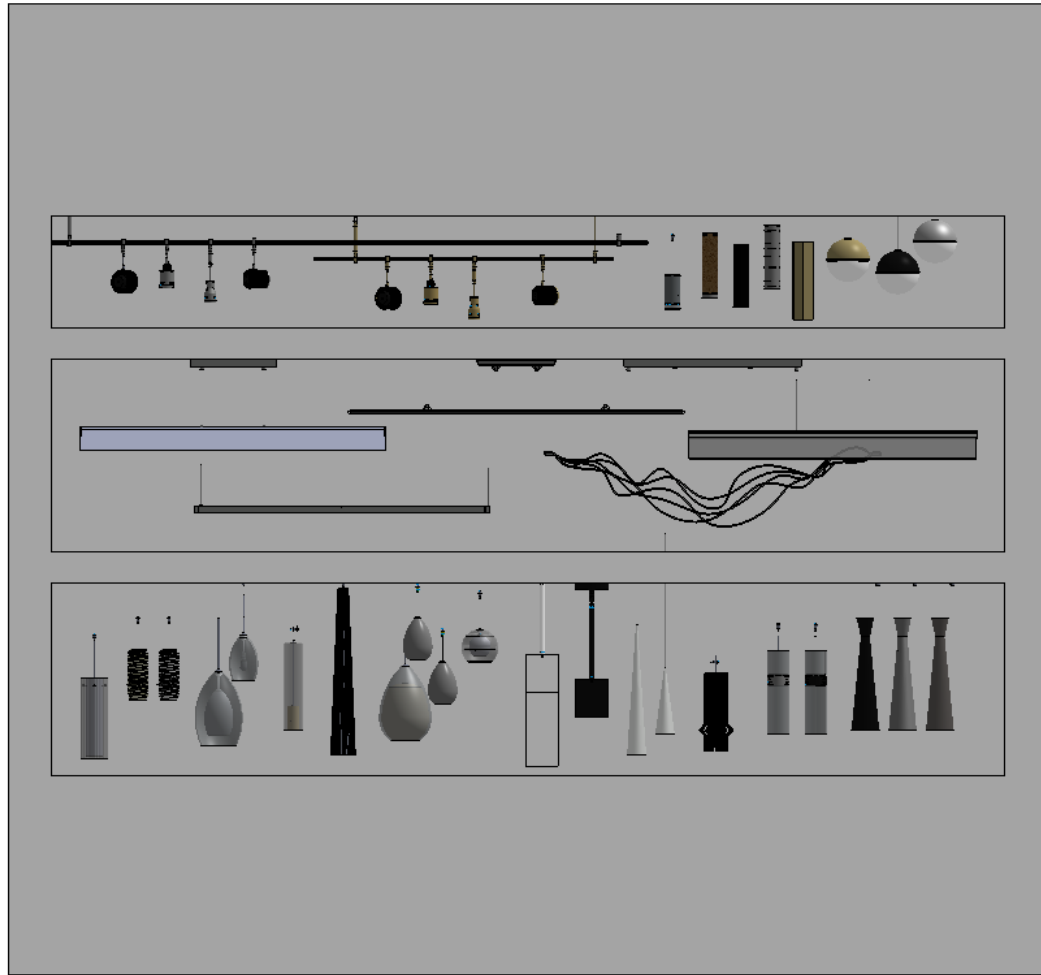

FLOOR PLAN

Decorative Niche

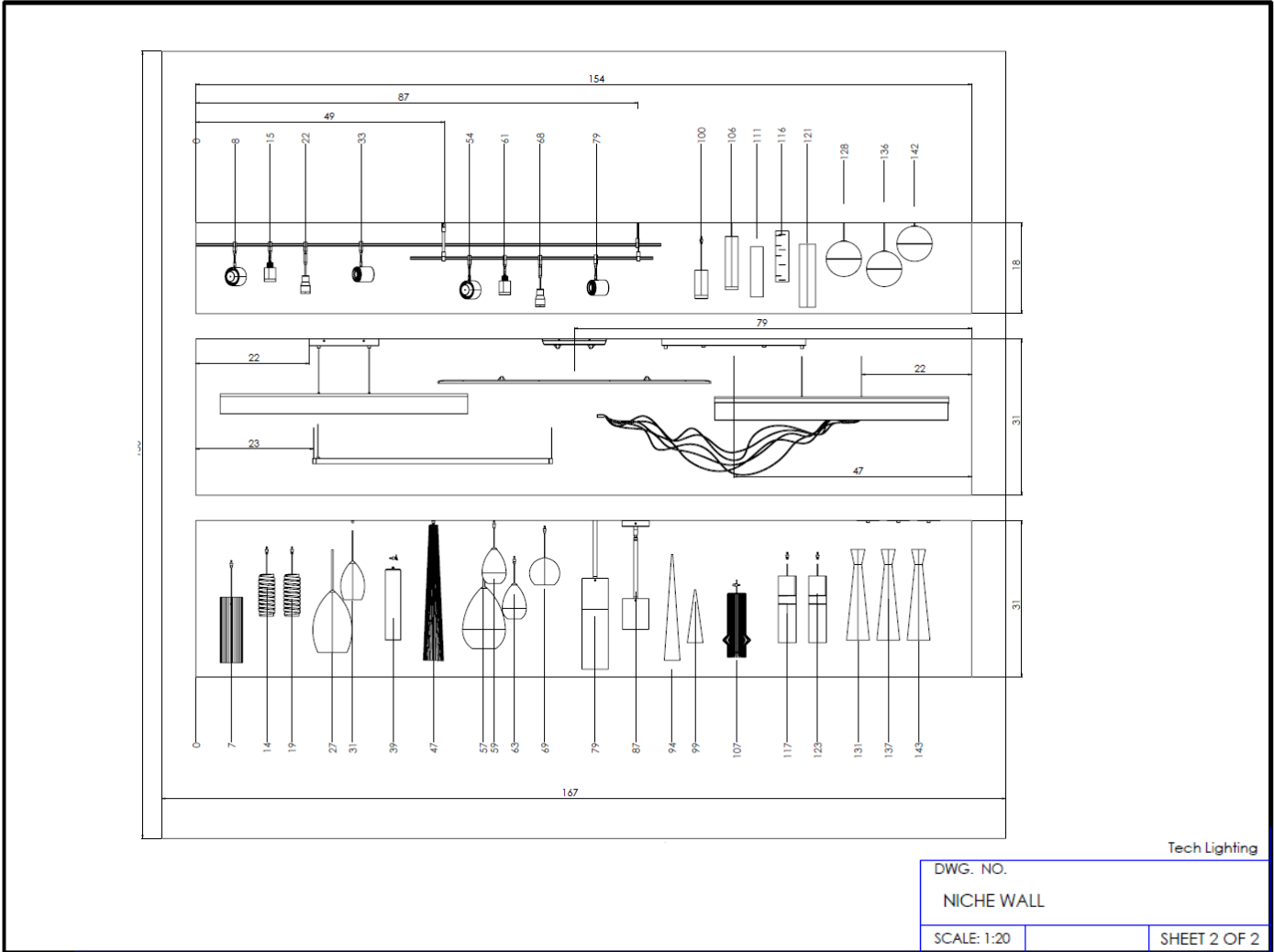

THE INFORMATION CONTAINED IN THIS DRAWING IS THE SOLE PROPERTY OF GENERATION LIGHTING. ANY REPRODUCTION IN PART OR AS A WHOLE WITHOUT THE WRITTEN PERMISSION OF GENERATION LIGHTING IS PROHIBITED.



FLOOR PLAN

WALL

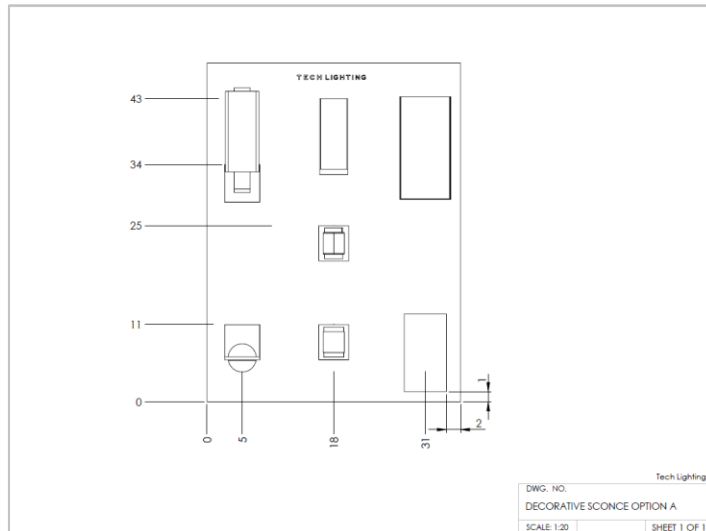
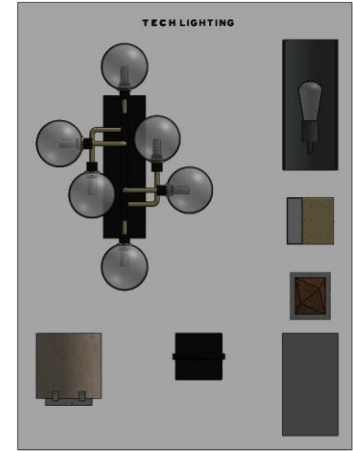
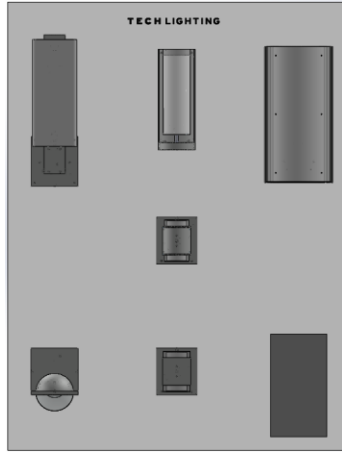

THE INFORMATION CONTAINED IN THIS DRAWING IS THE SOLE PROPERTY OF GENERATION LIGHTING. ANY REPRODUCTION IN PART OR AS A WHOLE WITHOUT THE WRITTEN PERMISSION OF GENERATION LIGHTING IS PROHIBITED.

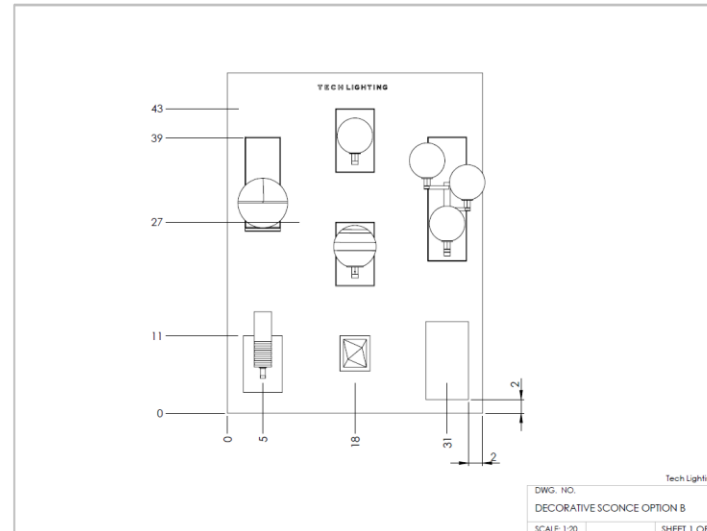

THE INFORMATION CONTAINED IN THIS DRAWING IS THE SOLE PROPERTY OF GENERATION LIGHTING. ANY REPRODUCTION IN PART OR AS A WHOLE WITHOUT THE WRITTEN PERMISSION OF GENERATION LIGHTING IS PROHIBITED.

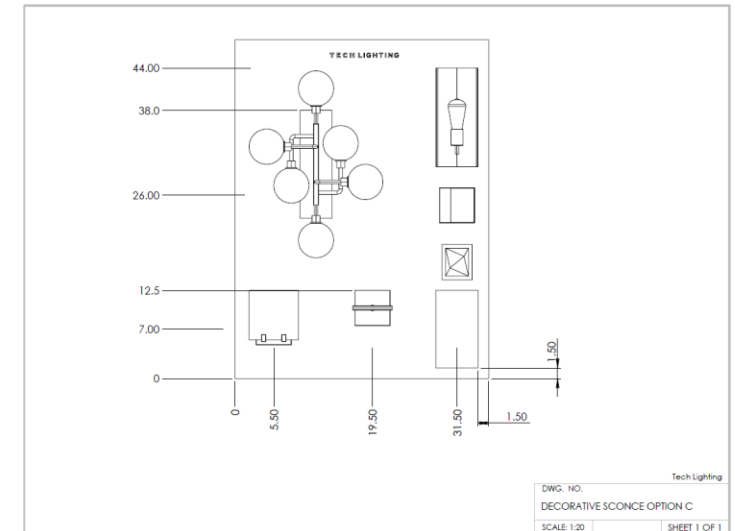

THE INFORMATION CONTAINED IN THIS DRAWING IS THE SOLE PROPERTY OF GENERATION LIGHTING. ANY REPRODUCTION IN PART OR AS A WHOLE WITHOUT THE WRITTEN PERMISSION OF GENERATION LIGHTING IS PROHIBITED.



FLOOR PLAN

BATH & WALL

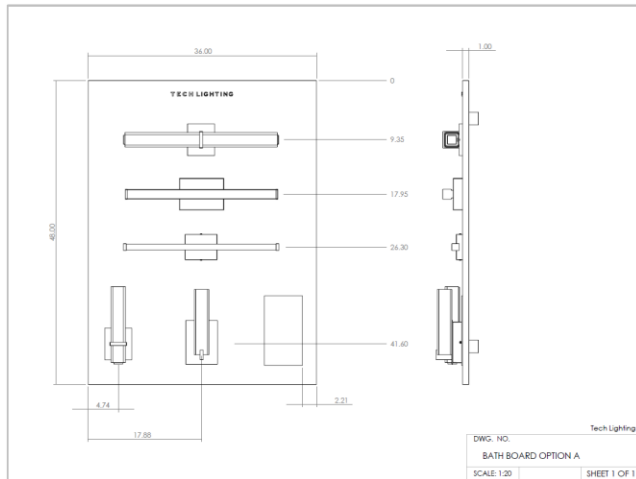
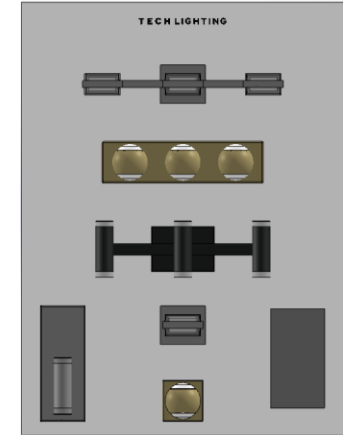
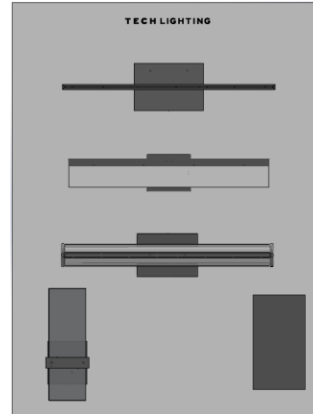
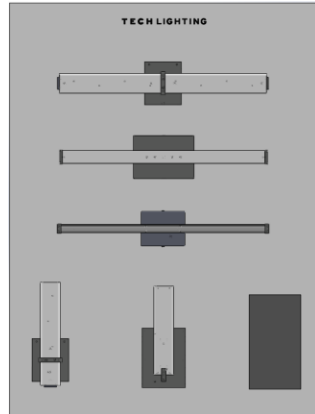

THE INFORMATION CONTAINED IN THIS DRAWING IS THE SOLE PROPERTY OF CREATION LIGHTING. ANY REPRODUCTION IN PART OR AS A WHOLE WITHOUT THE WRITTEN PERMISSION OF CREATION LIGHTING IS PROHIBITED.

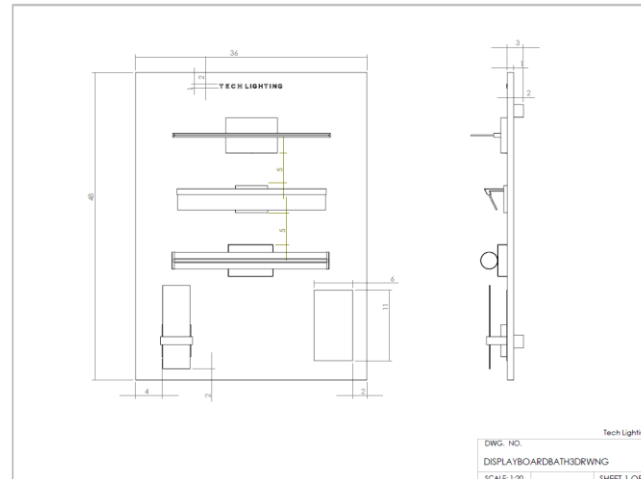

THE INFORMATION CONTAINED IN THIS DRAWING IS THE SOLE PROPERTY OF CREATION LIGHTING. ANY REPRODUCTION IN PART OR AS A WHOLE WITHOUT THE WRITTEN PERMISSION OF CREATION LIGHTING IS PROHIBITED.

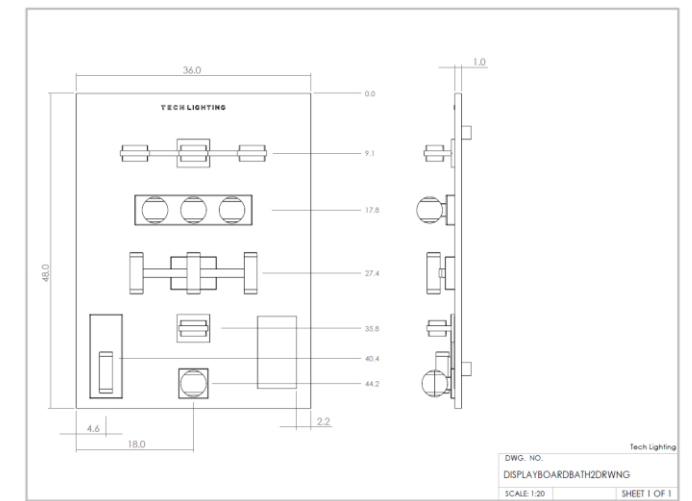

THE INFORMATION CONTAINED IN THIS DRAWING IS THE SOLE PROPERTY OF CREATION LIGHTING. ANY REPRODUCTION IN PART OR AS A WHOLE WITHOUT THE WRITTEN PERMISSION OF CREATION LIGHTING IS PROHIBITED.



BOARD AND CLEAT SYSTEM

BATH & WALL BOARD

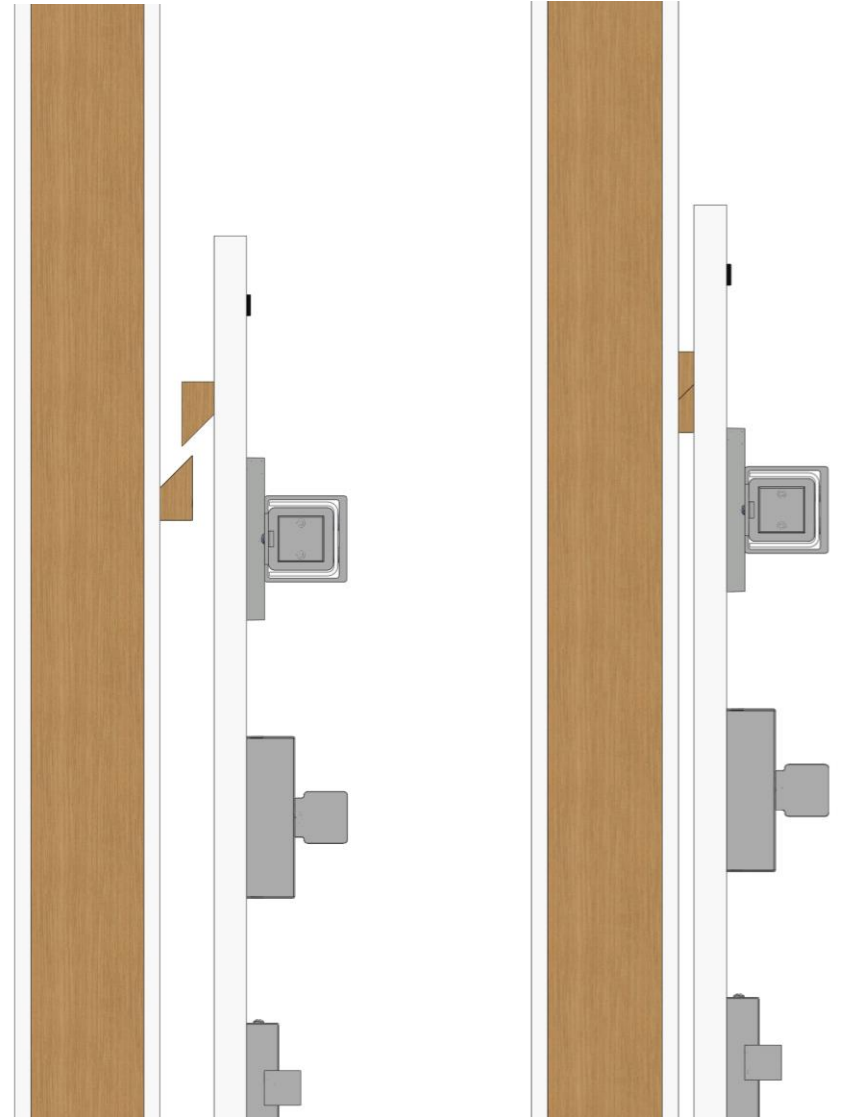
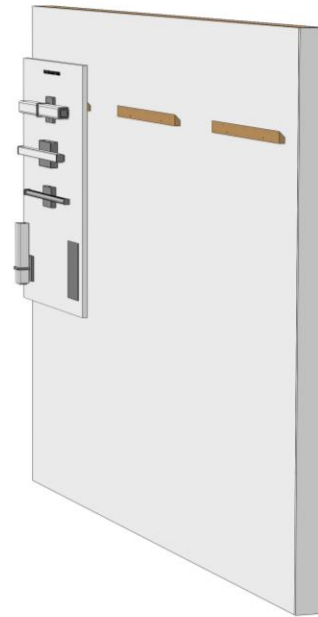

FRENCH CLEAT
2X4 BOARD



Top board will be mounted to the back of the cut MDF board

Cut 1x3 in half with a 45° deg. cut

Lower board will be mounted to the wall – find studs for secure anchor



BOARD AND CLEAT SYSTEM

BATH & WALL BOARD

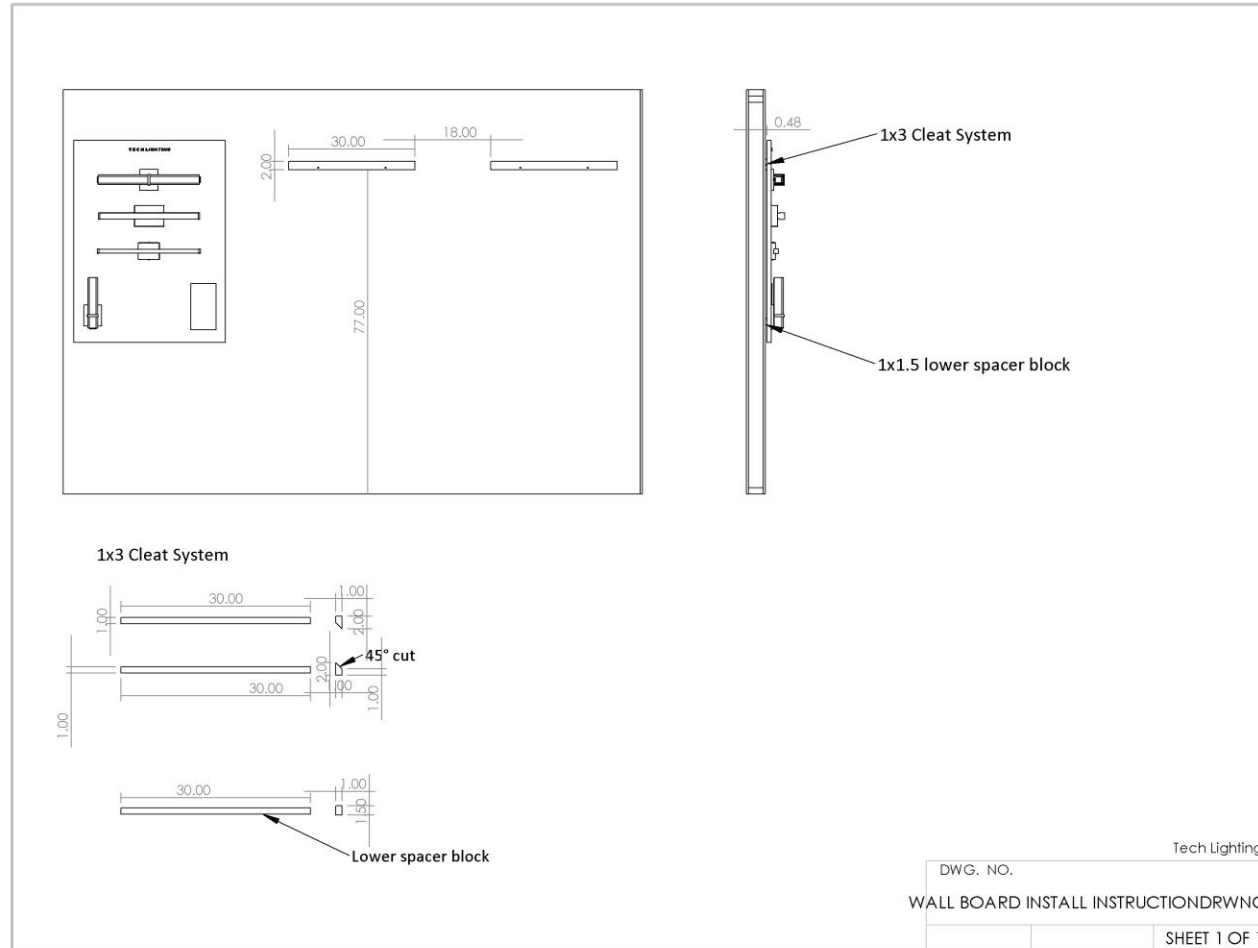

THE INFORMATION CONTAINED IN THIS DRAWING IS THE SOLE PROPERTY OF GENERATION LIGHTING. ANY REPRODUCTION IN PART OR AS A WHOLE WITHOUT THE WRITTEN PERMISSION OF GENERATION LIGHTING IS PROHIBITED.



FLOOR PLAN

OUTDOOR WALL AND PATH

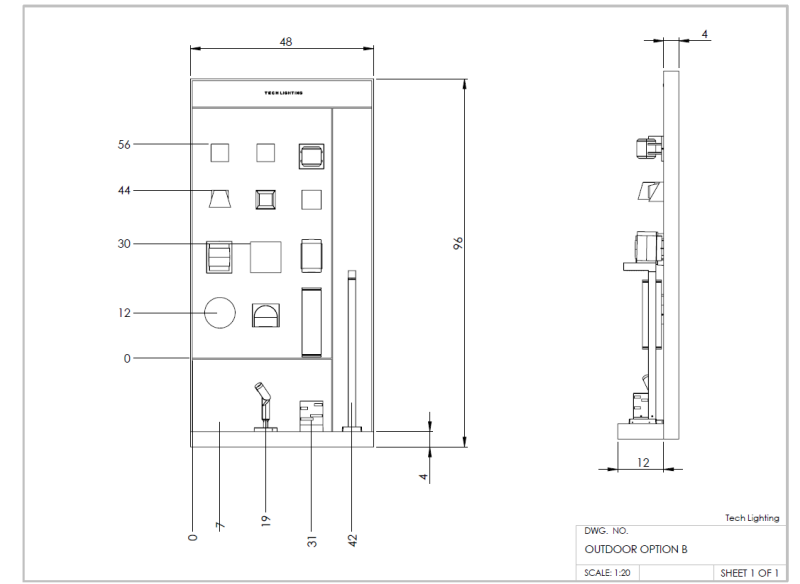
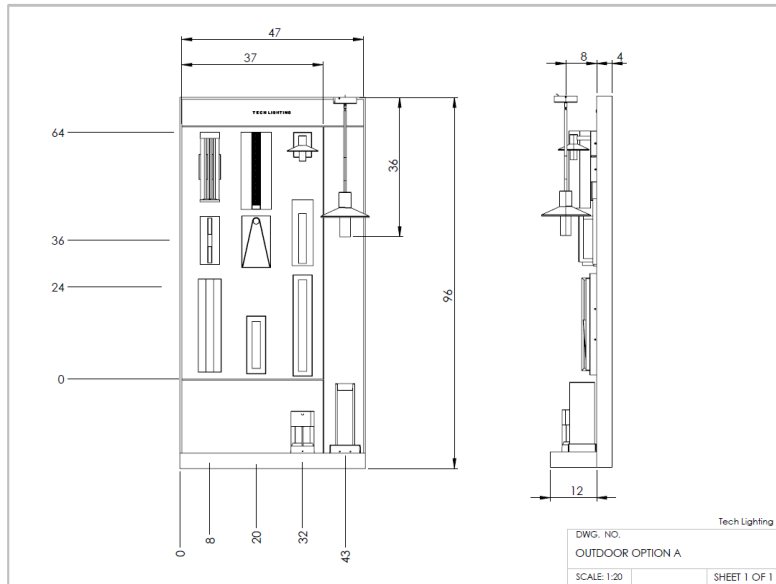
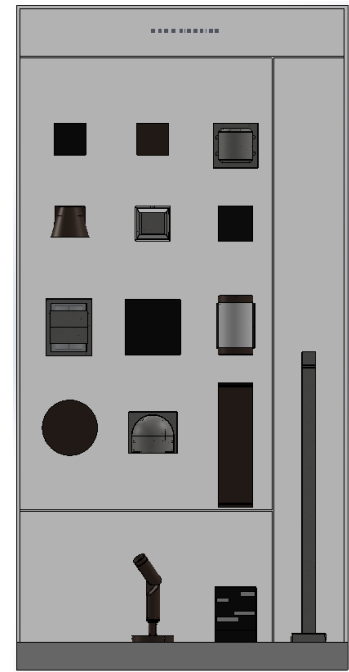
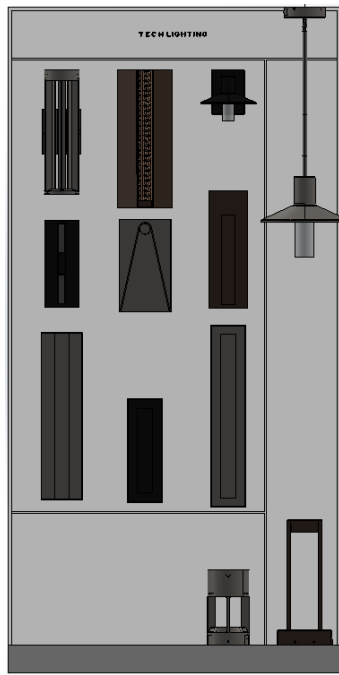

THE INFORMATION CONTAINED IN THIS DRAWING IS THE SOLE PROPERTY OF GENERATION LIGHTING. ANY REPRODUCTION IN PART OR AS A WHOLE WITHOUT THE WRITTEN PERMISSION OF GENERATION LIGHTING IS PROHIBITED.

THE INFORMATION CONTAINED IN THIS DRAWING IS THE SOLE PROPERTY OF GENERATION LIGHTING. ANY REPRODUCTION IN PART OR AS A WHOLE WITHOUT THE WRITTEN PERMISSION OF GENERATION LIGHTING IS PROHIBITED.



BOARD AND CLEAT SYSTEM

OUTDOOR WALL AND PATH

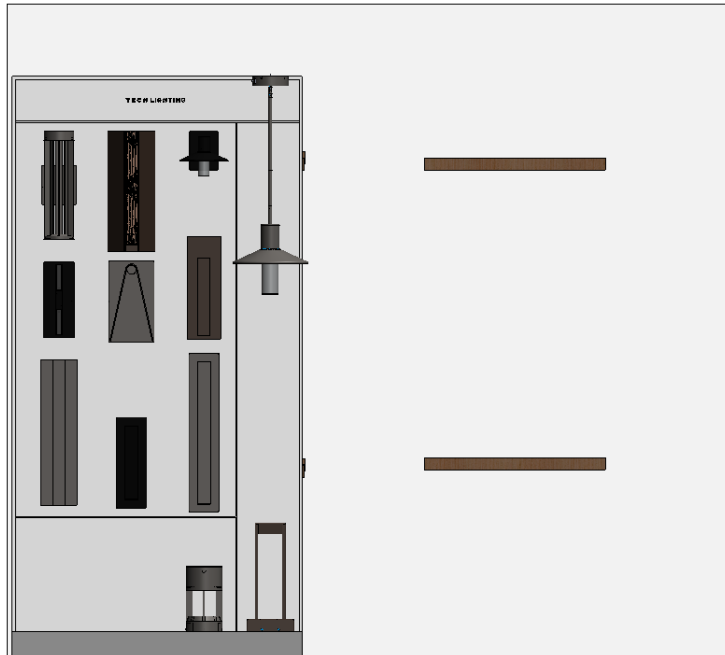

FRENCH CLEAT
2X4 BOARD



Top board will be mounted to the back of the cut MDF board

Cut 1x3 in half with a 45° deg. cut

Lower board will be mounted to the wall – find studs for secure anchor

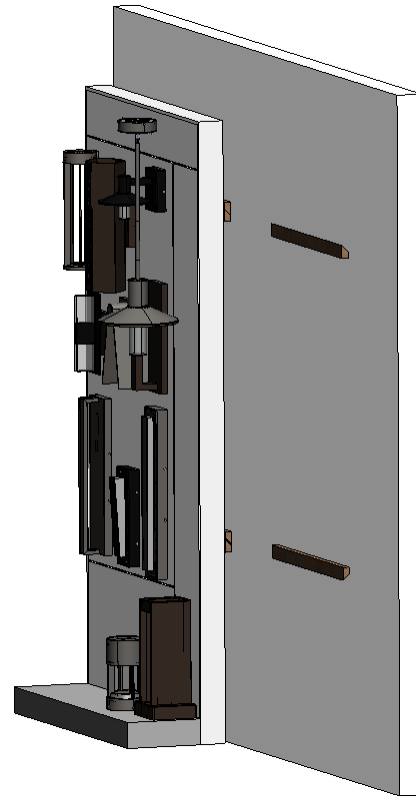

BOARD AND CLEAT SYSTEM

OUTDOOR WALL AND PATH

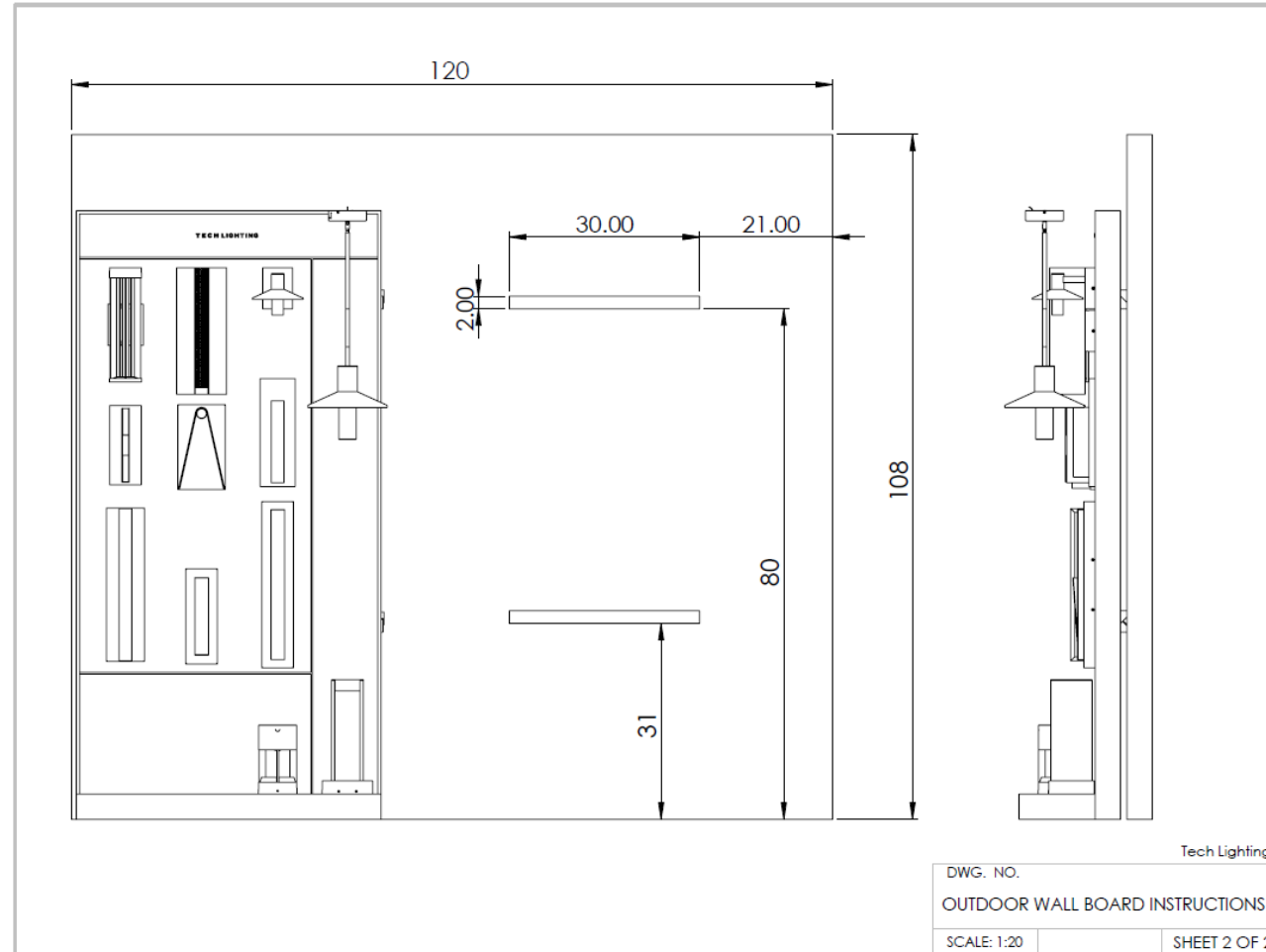

THE INFORMATION CONTAINED IN THIS DRAWING IS THE SOLE PROPERTY OF GENERATION LIGHTING. ANY REPRODUCTION IN PART OR AS A WHOLE WITHOUT THE WRITTEN PERMISSION OF GENERATION LIGHTING IS PROHIBITED.



DISPLAY GALLERY TWO

BACK WALL: SYSTEM, LINEAR & PENDANT

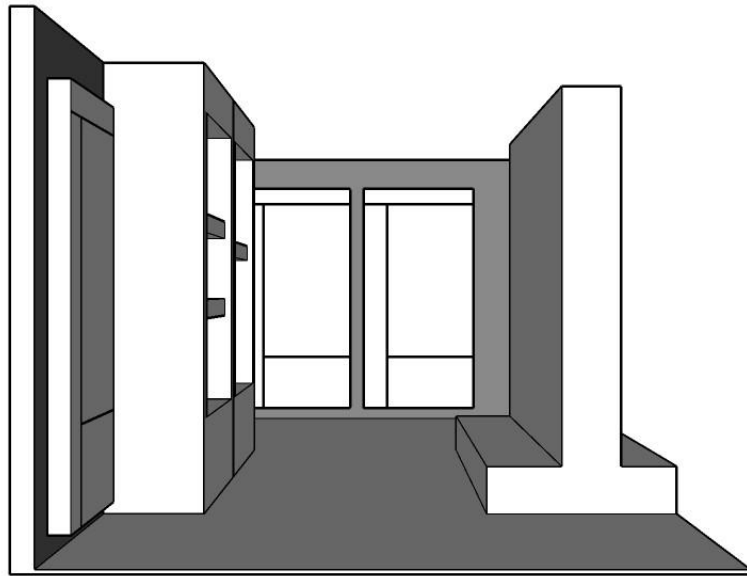

GALLERY: SIDE VIEW

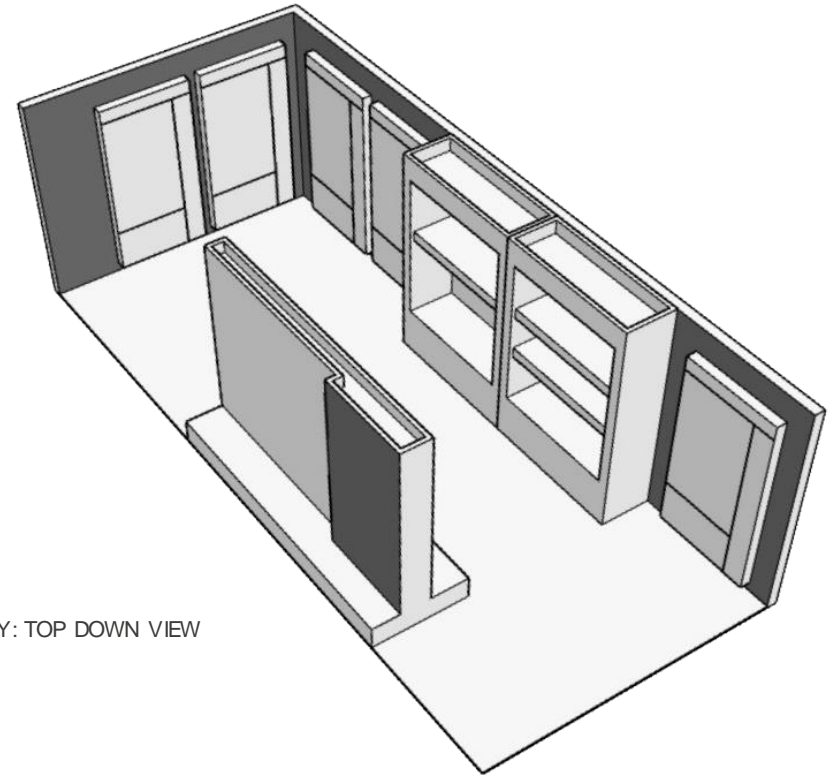

GALLERY: TOP DOWN VIEW





ASSORTMENT



M A Y 2 1 , 2 0 1 8