

COLORADO CUSTOM

2004

PRICE
GUIDE

CUSTOM WHEELS

STEERING WHEELS

CAR AND TRUCK ACCESSORIES

MOTORCYCLE WHEELS AND ACCESSORIES



BILLETSERIES



LOCK-DOWN
SERIES



T&A
SERIES

VEHICLE FITMENT

After determining that the selected wheel meets the technical requirements of a particular vehicle, make sure it is compatible with the physical aspects, such as suspension clearance, tie rod ends, A-arms, brake calipers, shocks, and shock mounts are potential trouble spots. Clearance should be carefully checked first with the suspension collapsed and then fully extended (topped out).

Another area of concern is both the inside and outside of the fender area. This should be carefully checked with the wheels turned lock to lock from right to left with the car static and again with the suspension fully collapsed.

Test Fit Program is available for customers who want to verify fitment prior to purchase: Full payment is required.

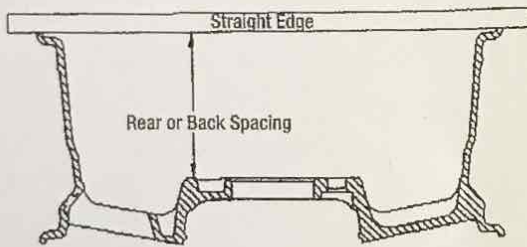
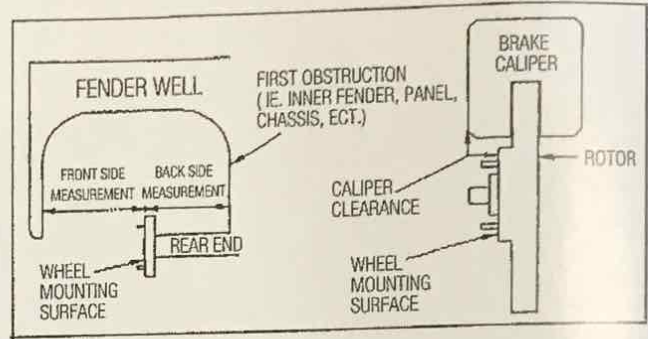

MEASURING REAR OR BACK SPACING

WHEEL FASTENER TYPE

Acorn Nut

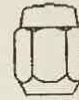

60° Conical Seat Conical Bolt

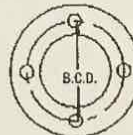

4 Lug

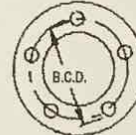

5 Lug

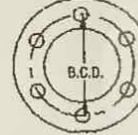

6 Lug



8 Lug

MEASURING BOLT CIRCLE DIAMETER

PLUS ONE, PLUS TWO: EXPLAINED

Plus One and Plus Two is a concept which allows a larger diameter wheel combined with a low aspect tire efficiently reduce tire sidewall flex. The shorter distance from the wheel to the road provides quicker response to steering input and greatly improves cornering ability, response, and overall handling stability.

Plus One increases the wheel diameter one size (i.e. 14" in 15") which allows a lower aspect tire without changing the overall height from the stock (OEM) wheel and tire combination.

Plus Two will increase the wheel diameter two sizes (i.e. 14" to 16") which allows for an even lower aspect tire. For example: a P205/70R14 can be replaced by a P225/50R16 without changing the overall height.

Because the overall height has not changed, there is no interference with fender or inner panels and no major body or suspension modifications are required.

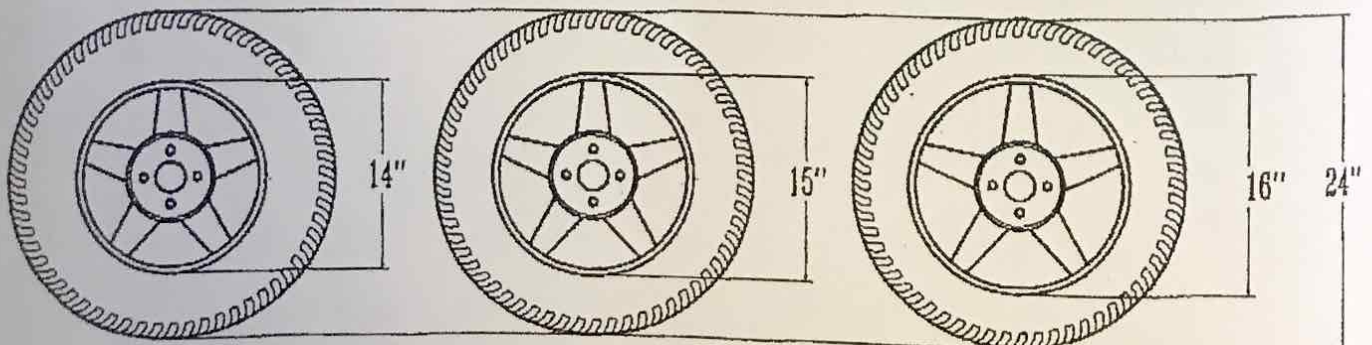

T&A SERIES

T&A SERIES

LOCK DOWN SERIES

SIZE	M.S.R.P.	JOBBER	M.S.R.P.	JOBBER	BACKSPACE MIN.	MAX.
17 x 7	\$1,325.00	\$1,220.00	\$760.00	\$700.00	2.5	4.825
17 x 7 s	\$1,335.00	\$1,230.00	\$805.00	\$740.00	4.0	6.0
17 x 8	\$1,325.00	\$1,220.00	\$780.00	\$720.00	2.5	5.825
17 x 8 s	\$1,355.00	\$1,250.00	\$805.00	\$740.00	4.0	7.0
17 x 9	\$1,345.00	\$1,240.00	\$790.00	\$730.00	2.5	6.825
17 x 9.5	\$1,335.00	\$1,230.00	\$780.00	\$720.00	2.5	7.325
17 x 10 s	\$1,365.00	\$1,260.00	\$815.00	\$750.00	4.0	9.0
17 x 11	\$1,345.00	\$1,240.00	\$790.00	\$730.00	2.5	10.325
17 x 12	\$1,585.00	\$1,460.00	\$1,030.00	\$950.00	2.5	9.825
18 x 7	\$1,390.00	\$1,280.00	\$845.00	\$780.00	2.5	4.825
18 x 7 s	\$1,455.00	\$1,340.00	\$900.00	\$830.00	4.0	6.0
18 x 8	\$1,390.00	\$1,280.00	\$845.00	\$780.00	2.5	5.825
18 x 8 s	\$1,455.00	\$1,340.00	\$900.00	\$830.00	4.0	7.0
18 x 9 s	\$1,455.00	\$1,340.00	\$900.00	\$830.00	4.0	8.0
18 x 9.5	\$1,400.00	\$1,290.00	\$845.00	\$780.00	2.5	7.325
18 x 10 s	\$1,465.00	\$1,350.00	\$910.00	\$840.00	4.0	9.0
18 x 12	\$1,630.00	\$1,500.00	\$1,085.00	\$1,000.00	2.5	9.625
19 x 8 s	\$1,520.00	\$1,400.00	\$945.00	\$870.00	4.0	7.0
19 x 10	\$1,725.00	\$1,590.00	\$1,085.00	\$1,000.00	2.5	7.825
19 x 10 s	\$1,530.00	\$1,410.00	\$945.00	\$870.00	4.0	9.0
20 x 8	\$1,620.00	\$1,490.00	\$1,030.00	\$950.00	2.5	5.825
20 x 8.5 s	\$1,620.00	\$1,540.00	\$1,085.00	\$1,000.00	4.0	7.5
20 x 9.5	\$1,630.00	\$1,500.00	\$1,040.00	\$960.00	2.5	7.425
20 x 10 s	\$1,680.00	\$1,550.00	\$1,085.00	\$1,000.00	4.0	9.0
20 x 12	\$1,845.00	\$1,700.00	\$1,250.00	\$1,150.00	2.5	7.825
22 x 8.5 s	\$2,335.00	\$2,150.00	\$2,335.00	\$2,150.00	4.0	7.5
22 x 10	\$2,500.00	\$2,300.00	\$2,500.00	\$2,300.00	2.5	7.825
22 x 10 s	\$2,550.00	\$2,350.00	\$2,550.00	\$2,350.00	4.0	9.0



: PALMDALE :



: RENTON :



: WITCHITA :

s Soft Look

LOCK-DOWN SERIES

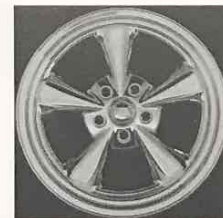

: ALCATRAZ :

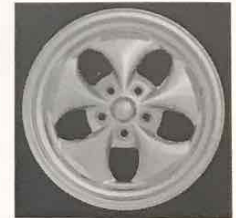

: ATTICA :



: FOLSOM :



: LEVENSWORTH :



: MARION :

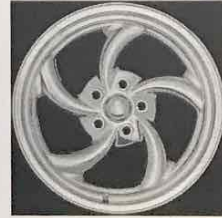

: RYKERS ISLAND :

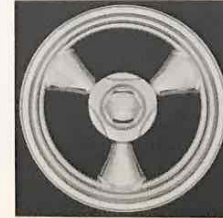

: SAN QUINTIN :



: SING SING :

CUSTOM

SUPERIOR SERIES

SIZE	M.S.R.P.	JOBBER	BACKSPACE	
			MIN.	MAX.
14 x 6	\$530.00	\$500.00	2.5	3.875
14 x 7	\$530.00	\$500.00	2.5	4.825
15 x 3.5	\$720.00	\$680.00	1.425	1.925
15 x 5	\$720.00	\$680.00	2.5	2.825
15 x 6	\$530.00	\$500.00	2.5	3.925
15 x 7	\$530.00	\$500.00	2.5	4.825
15 x 8	\$530.00	\$500.00	2.5	4.825
15 x 10	\$550.00	\$520.00	2.5	7.825
15 x 12	\$575.00	\$540.00	2.5	8.0
15 x 14	\$765.00	\$720.00	2.5	8.0
15 x 15	\$765.00	\$720.00	2.5	8.0
15 x 16	\$765.00	\$720.00	2.5	8.0
16 x 7	\$550.00	\$520.00	2.5	4.825
16 x 8	\$550.00	\$520.00	2.5	5.825
16 x 9.5	\$570.00	\$540.00	2.5	7.325
16.5 x 9.75	\$570.00	\$540.00	2.5	7.325
17 x 7	\$620.00	\$570.00	2.5	4.825
17 x 7 s	\$650.00	\$600.00	4.0	6.0
17 x 8	\$650.00	\$600.00	2.5	5.825
17 x 8 s	\$650.00	\$600.00	4.0	7.0
17 x 9	\$650.00	\$600.00	2.5	6.825
17 x 9.5	\$640.00	\$590.00	2.5	7.325
17 x 10 s	\$675.00	\$620.00	4.0	9.0
17 x 11	\$650.00	\$600.00	2.5	10.325
17 x 12	\$870.00	\$800.00	2.5	9.825
18 x 7	\$685.00	\$630.00	2.5	4.825
18 x 7 s	\$760.00	\$700.00	4.0	6.0
18 x 8	\$685.00	\$630.00	2.5	5.825
18 x 8 s	\$760.00	\$700.00	4.0	7.0
18 x 9 s	\$760.00	\$700.00	4.0	8.0
18 x 9.5	\$695.00	\$640.00	2.5	7.325
18 x 10 s	\$760.00	\$700.00	4.0	9.0
18 x 12	\$935.00	\$860.00	2.5	9.625
19 x 8 s	\$780.00	\$720.00	4.0	7.0
19 x 10	\$980.00	\$900.00	2.5	7.825
19 x 10 s	\$790.00	\$730.00	4.0	9.0
20 x 8	\$910.00	\$840.00	2.5	5.825
20 x 8.5 s	\$970.00	\$890.00	4.0	7.5
20 x 9.5	\$920.00	\$850.00	2.5	7.425
20 x 10 s	\$980.00	\$900.00	4.0	9.0
20 x 12	\$1,085.00	\$1,000.00	2.5	7.825
22 x 8.5 s	\$1,195.00	\$1,100.00	4.0	7.5
22 x 10	\$1,015.00	\$935.00	2.5	7.825
22 x 10 s	\$1,195.00	\$1,100.00	4.0	9.0



: AKRON :



: ALAMOSA :

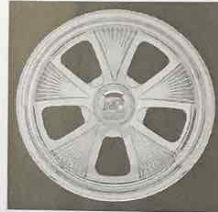

: APEX :



: AROYA :



: ARRIBA :



: BOWMAR :



: BRECKENRIDGE :



: BUFFALO CREEK :



: CIMARRON :



: CLIMAX :



: COPPER MOUNTAIN :

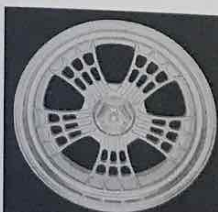

: CRAWLEY :



: CREED :



: DACONO :

Many Styles Available
in 4, 5, and 6 Lug



: EMPIRE :



: EMPIRE III :



: FIRE :



: FLAT IRONS :



: GRANBY :



: GUNNISON :



: HANCOCK :



: HANCOCK II :



: JULESBURG :



: KEYSTONE :



: LANTANA II :



: LAZEAR :



: LEADVILLE :



: LEADVILLE ACE :



: LITTLETON :



: MONTE VISTA :

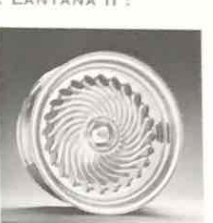

: MYSTIC :



: PIKES PEAK :



: ROCK CREEK :



: RUSH :



: SEGUNDO :



: SEVERANCE :



: SLATER :



: SNOWMASS :



: SOMERSET :



: SOMERSET IV :



: SOUTH PARK :

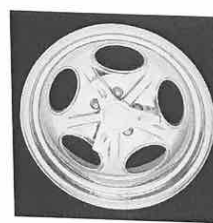

: SUGAR CITY ⁰⁰⁰⁰ :



: VALDEZ :



: WHISKEY :



: WILD HORSE :



: WINDSOR :



: WINTER PARK :



: WRAY :



: YUMA :

⁰⁰⁰⁰ Optional Knock-off shown



: DELRAY II :



: DELTONA II :



: DIAMOND FLUSH II :



: MIRAMAR II :

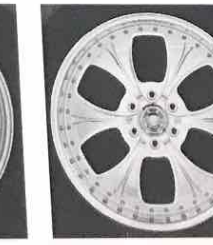

: OSPREY II :

THESE WHEELS ARE THE SAME PATTERN AS THE ONE PIECE WHEEL BUT ARE IN A TWO PIECE FITTMENT. THEY ARE PRICED THE SAME AS THE SUPERIOR SERIE WHEELS.



: BELLEAIR :

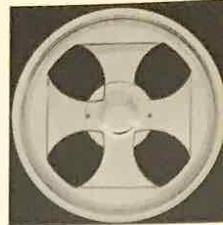

: BIG FLAT IRON :



: DELRAY :

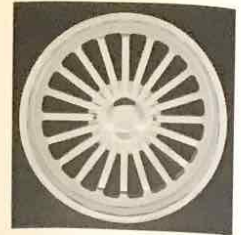

: DELTONA :

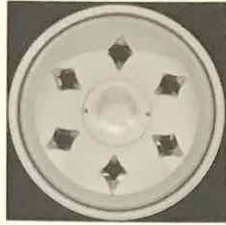

: DIAMOND FLUSH :



: LANTANA :

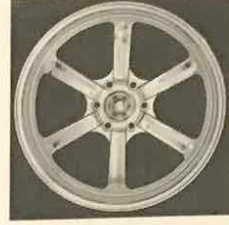

: MIRAMAR :



: OSPREY :

SPS SERIES

SIZE	M.S.R.P.	JOBBER
20 x 8.5	\$890.00	\$820.00
22 x 9	\$980.00	\$900.00

SPS CHROME SERIES

M.S.R.P.	JOBBER	BACKSPACE / OFFSET	
		MIN.	MAX.
\$1,310.00	\$1,205.00	5.0	5.0
\$1,390.00	\$1,283.00	5.5	5.5



: SIGNATURE :

ONLY AVAILABLE ON THE DELRAY

CALL FOR PRICING

SIGNATURE SINGLE-PIECE WHEEL

THE SIGNATURE SINGLE-PIECE WHEEL ALLOWS YOU TO EXPRESS YOUR INDIVIDUALITY AND IS TRULY THE REASON FOR OUR NAME. IT'S COMPLETELY CUSTOM TO YOU: CHOOSE FROM A VARIETY OF FONTS TO ADD YOUR INITIALS ON EACH SPOKE, PUT YOUR COMPANY LOGO, OR BE UNIQUE AND PUT YOUR SIGNATURE ON EACH WHEEL. NO MATTER WHAT YOU CHOOSE TO SIGN YOUR WHEEL, YOU KNOW YOU'RE ROLLIN' SUPERIOR STYLE.

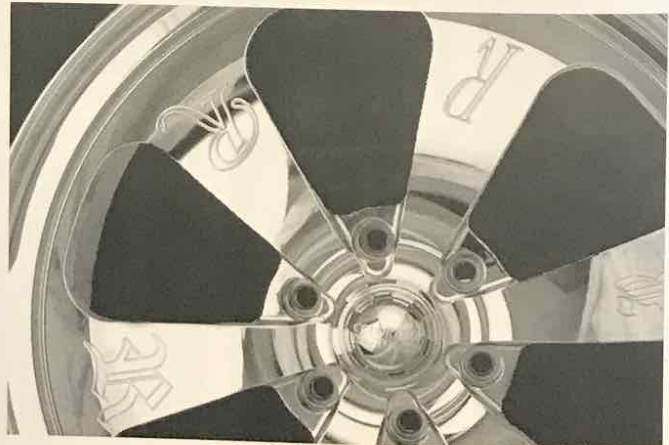

COLORADO CUSTOM
 363 JEFFERSON ST., STE. 101
 FORT COLLINS, CO 80524
 • 970-224-5750 •
 FAX: 970-472-8084
 WWW.COLORADOCUSTOM.COM

TURN & BURN SERIES

TURN AND BURN SERIES JOBBER

SIZE	M.S.R.P.	JOBBER	BACKSPACE	
			MIN.	MAX.
17 x 7 s	\$651.00	\$600.00	4 / 0	6 / +50mm
17 x 8 s	\$651.00	\$600.00	4 / -13mm	7 / +63mm
18 x 7 s	\$760.00	\$700.00	4 / 0	5 / +50mm
18 x 8 s	\$760.00	\$700.00	4 / -13mm	7 / +63mm
19 x 8 s	\$781.00	\$720.00	4 / -13mm	7 / +63mm
20 x 8.5 s	\$966.00	\$890.00	4 / -19mm	7.5 / +69mm

s Soft Look



: CARSON CITY II :

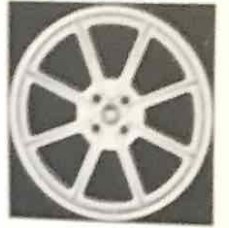

: LAS VEGAS II :



: LAUGHLIN II :



: RENO II :

8 LUG SERIES

SIZE	M.S.R.P.	JOBBER	BACKSPACE	
			MIN.	MAX.
16 x 8	\$550.00	\$520.00	2.5	5.825
16.5 x 9.75	\$570.00	\$540.00	2.5	7.325
17 x 8	\$650.00	\$600.00	2.5	5.825
17 x 11	\$650.00	\$600.00	2.5	10.325
18 x 8	\$650.00	\$600.00	2.5	5.825
20 x 8	\$640.00	\$590.00	2.5	5.825
20 x 9.5	\$675.00	\$620.00	2.5	7.425
20 x 10 s	\$650.00	\$600.00	4	9
22 x 10	\$870.00	\$800.00	2.5	7.825



: APEX 8 :



: BOULDER 8 :



: HANCOCK 8 :



: MYSTIC 8 :



: SNOWMASS 8 :

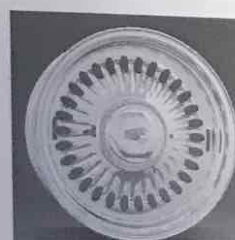

: VALDEZ 8 :

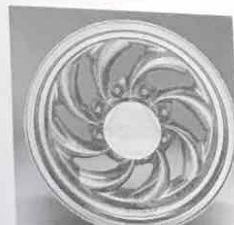

: WHISKEY 8 :



: YUMA 8 :

8 LUG SERIES

BILLET SERIES

SIZE	M.S.R.P.	JOBBER	BACKSPACE MIN.	BACKSPACE MAX.
14 x 6	\$415.00	\$390.00	2.5	3.875
14 x 7	\$405.00	\$380.00	2.5	4.825
15 x 3.5	\$595.00	\$560.00	1.425	1.925
15 x 5	\$595.00	\$560.00	2.5	2.825
15 x 6	\$405.00	\$380.00	2.5	3.925
15 x 7	\$405.00	\$380.00	2.5	4.825
15 x 8	\$405.00	\$380.00	2.5	4.825
15 x 10	\$425.00	\$400.00	2.5	7.825
15 x 12	\$445.00	\$420.00	2.5	8.0
15 x 14	\$635.00	\$600.00	2.5	8.0
15 x 15	\$635.00	\$600.00	2.5	8.0
15 x 16	\$720.00	\$680.00	2.5	8.0
16 x 7	\$425.00	\$400.00	2.5	4.825
16 x 8	\$425.00	\$400.00	2.5	5.825
16 x 9.5	\$445.00	\$420.00	2.5	7.325
16.5 x 9.75	\$445.00	\$420.00	2.5	7.325
17 x 7	\$435.00	\$400.00	2.5	4.825
17 x 7 s	\$480.00	\$440.00	4.0	6.0
17 x 8	\$455.00	\$420.00	2.5	5.825
17 x 8 s	\$475.00	\$440.00	4.0	7.0
17 x 9	\$470.00	\$430.00	2.5	6.825
17 x 9.5	\$470.00	\$430.00	2.5	7.325
17 x 10 s	\$490.00	\$450.00	4.0	9.0
17 x 11	\$470.00	\$430.00	2.5	10.325
17 x 12	\$705.00	\$650.00	2.5	9.825
18 x 7	\$530.00	\$490.00	2.5	4.825
18 x 7 s	\$590.00	\$540.00	4.0	6.0
18 x 8	\$530.00	\$490.00	2.5	5.825
18 x 8 s	\$590.00	\$540.00	4.0	7.0
18 x 9 s	\$600.00	\$550.00	4.0	8.0
18 x 9.5	\$545.00	\$500.00	2.5	7.325
18 x 10 s	\$600.00	\$550.00	4.0	9.0
18 x 12	\$760.00	\$700.00	2.5	9.625
19 x 8 s	\$630.00	\$580.00	4.0	7.0
19 x 10	\$825.00	\$760.00	2.5	7.825
19 x 10 s	\$630.00	\$580.00	4.0	9.0
20 x 8	\$600.00	\$550.00	2.5	5.825
20 x 8.5 s	\$650.00	\$600.00	4.0	7.5
20 x 9.5	\$610.00	\$560.00	2.5	7.425
20 x 10 s	\$650.00	\$600.00	4.0	9.0
20 x 12	\$805.00	\$740.00	2.5	7.825
22 x 8.5 s	\$835.00	\$770.00	4.0	7.5
22 x 10	\$680.00	\$625.00	2.5	7.825
22 x 10 s	\$835.00	\$770.00	4.0	9.0

BILLET SERIES



: ARVADA :



: BOULDER ∞ :



: BRIGHTON :



: CHROMO :



: CIMARRON II :



: COPPER MOUNTAIN II :



: DENVER :



: DILLON :



: FORT LUPTON :



: HENDERSON :



: LA SALLE :

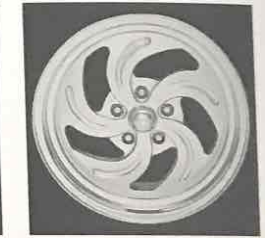

: LA SALLE II :



: MESA :



: MESA VERDE :



: MONTROSE :



: PARADOX :



: SLICK ROCK :

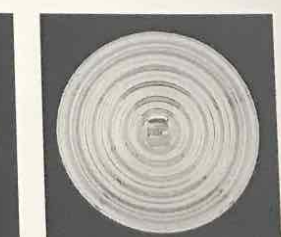

: WAVERLY :

ALAMOSA
 APEX
 AROYA
 ARRIBA
 ARVADA
 AURORA
 AURORA ACE
 BLACKHAWK
 BOULDER
 BOWMAR
 BRECKENRIDGE
 BRIGHTON
 BUFFALO CREEK
 CAREFREE
 CHROMO
 CIMARRON
 CIMARRON II
 CLASSIC
 CLIMAX
 CONIFER
 COPPER MOUNTIAN
 COPPER MOUNTAIN II
 CRAWLEY
 CREED
 DACONO
 DENVER
 DILLON
 DUAL DURANGO
 DURANGO
 EMPIRE
 EMPIRE II
 EMPIRE III
 FIRE
 FLAT IRONS
 FORT LUPTON
 FOXFIELD
 FOXTON
 GRANADA
 HANCOCK
 HANCOCK II
 HENDERSON
 JULESBURG
 KENNEDY
 LAFAYETTE
 LAFAYETTE II
 LAFAYETTE
 LAFAYETTE SLOTTED
 LITTLETON
 LITTLETON ACE
 MESA
 MESA VERDE
 MONTE VISTA
 MONTROSE
 MYSTIC
 PARADOX
 RUSH
 SEGUNDO
 SEVERANCE
 SLATER
 SLATER SLOTTED
 SLICK ROCK
 SNOWMASS
 SOMERSET
 SOMERSET IV
 SOUTHPARK
 STEAMBOAT
 STERLING
 SUGAR CITY
 TELLURIDE
 VALDEZ
 VAN NUYS
 WAVERLY
 WHISKEY
 WILD HORSE
 WINDSOR
 WINDSOR II
 WINTER PARK

14.0 STEERING WHEELS

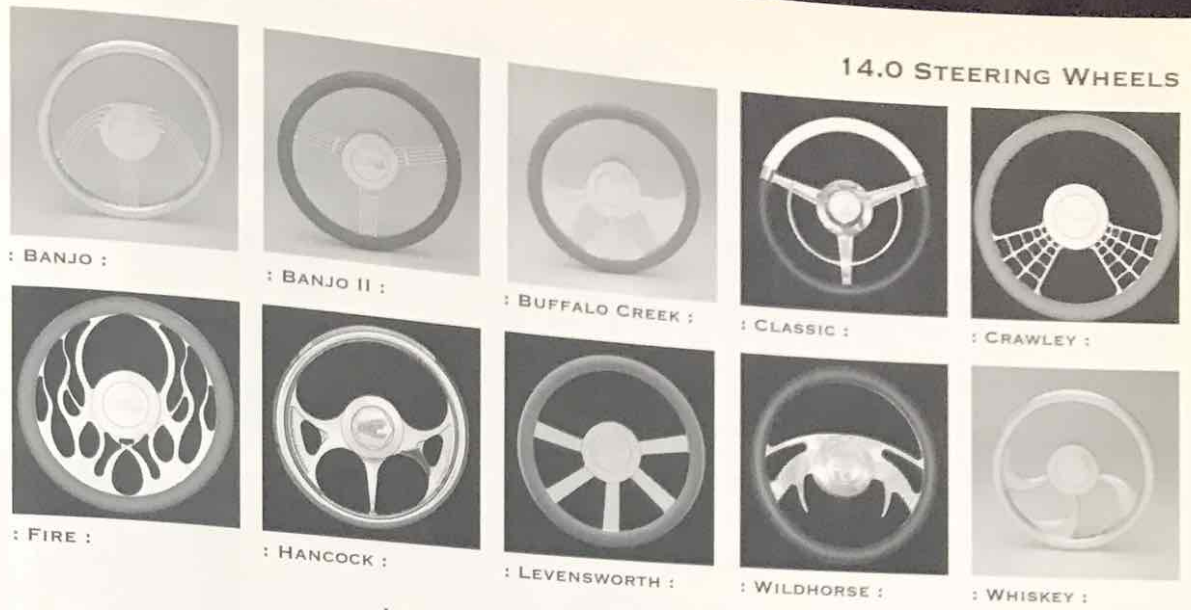

LEATHER COLORS AVAILABLE:

- : BLACK :
- : BLUE :
- : BONE :
- : BURGUNDY :
- : DARK GRAY :
- : DARK TAN :
- : LIGHT GRAY :
- : LIGHT TAN :
- : PURPLE :
- : RED :
- : WHITE :

STEERING WHEELS

	M.S.R.P.	JOBBER
Solid Steering Wheel w/Standard Horn Button	\$320.00	\$299.00
Split Grip Steering Wheel w/ Standard Horn Button	\$370.00	\$349.00
Two-Tone Split Steering Wheel w/ Standard Horn Button	\$425.00	\$399.00
Solid 16.5" Steering Wheel w/ Standard Horn Button	\$635.00	\$599.00
Gm Hub w/ Steering Wheel	\$55.00	\$50.00
Lg Horn Button w/ Steering Wheel	\$105.00	\$100.00
Standard Horn Button Assembly Only	\$55.00	\$50.00
Lg Horn Button Assembly Only	\$160.00	\$150.00
Leather Split Grip Only	\$80.00	\$75.00
Leather 2-Tone Split Only	\$105.00	\$100.00
GM Steering Wheel Hubs only	\$80.00	\$75.00

16.0 STEERING WHEELS

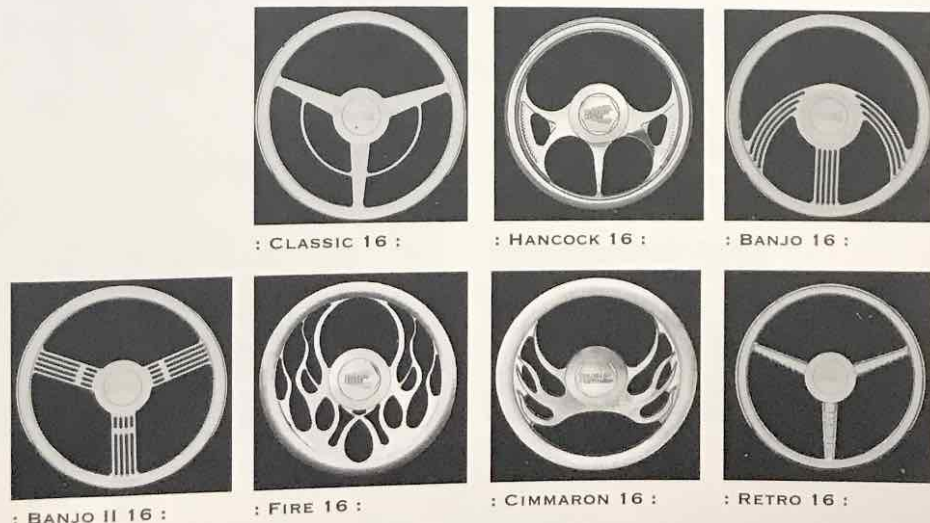

STEERING WHEELS

ACCESSORIES

		M.S.R.P.	JOBBER
CAP-01	3.0 THREADED CAP	\$85.00	\$80.75
CAP-03	2.5 THREADED CAP	\$85.00	\$80.75
CAP-04	3.5 THREADED CAP	\$85.00	\$80.75
CAP-05	2.5 SNAP CAP	\$60.00	\$57.00
CAP-06	3.0 SNAP CAP	\$60.00	\$57.00
CAP-07	3.5 SNAP CAP	\$60.00	\$57.00
CAP-08	8 LUG BOLT-ON CAP (SHORT 8.125)	\$120.00	\$114.00
CAP-09	8 LUG BOLT-ON CAP (TALL 8.125)	\$145.00	\$137.75
CAP-10	EXPOSED 8-LUG SNAP CAP (SHORT)	\$120.00	\$114.00
CAP-11	EXPOSED 8-LUG SNAP CAP (TALL)	\$145.00	\$137.75
CAP-12	BULLET 3.0 THREADED CAP	\$115.00	\$109.25
CAP-13	BULLET 3.0 SNAP CAP	\$115.00	\$109.25
CAP-14	7.400 BOLT ON CAP (S.P.S. SERIES)	\$120.00	\$114.00
CAP-19	3 SPOKE KNOCK-OFF (TALL)	\$180.00	\$162.00
CAP-20	3 SPOKE KNOCK-OFF (SHORT)	\$180.00	\$162.00
CAP-21	3.0 SNAP CAP EXTRA TALL	\$85.00	\$80.75
CAP-22	3.0 THREADED CAP (NO LOGO)	\$85.00	\$80.75
CAP-23	3.0 CRAWLEY THREADED CAP	\$115.00	\$1009.25
CAP-WN	THREADED CAP WRENCH	\$85.00	\$80.75
FLG	STANDARD FLANGE	\$85.00	\$80.75
FLG	MILLED WHEEL STYLE FLANGE	\$120.00	\$114.00

CALL FOR DRESS UP KIT PRICING

RETAIL NOTE: NO OTHER DISCOUNTS
BELOW JOBBER PRICES ON ACCESSORIES.



SNAP CAP



SIDE VIEW 8 LUG TALL CAP



SIDE VIEW SNAP CAP



FLANGE 7" OR 6"



8 LUG TALL CAP

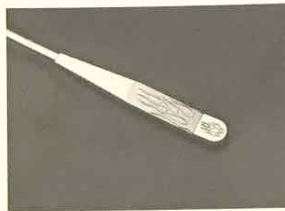

CUSTOM BILLET WIPERS FOR
GM, FORD, AND DODGE



THREADED DOME CAP



SIDE VIEW THREADED
DOME CAP



10 AND 12 INCH
SPEAKER COVERS



"TUNER" DRESS UP

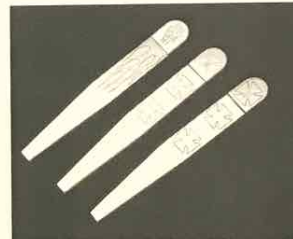

CUSTOM BILLET WIPERS FOR
GM, FORD, AND DODGE



KNOCKOFF SPINNER



HEMI FUSE COVER



HEMI ELECTRICAL
RELAY COVER



"TUNER" RADIATOR CAP

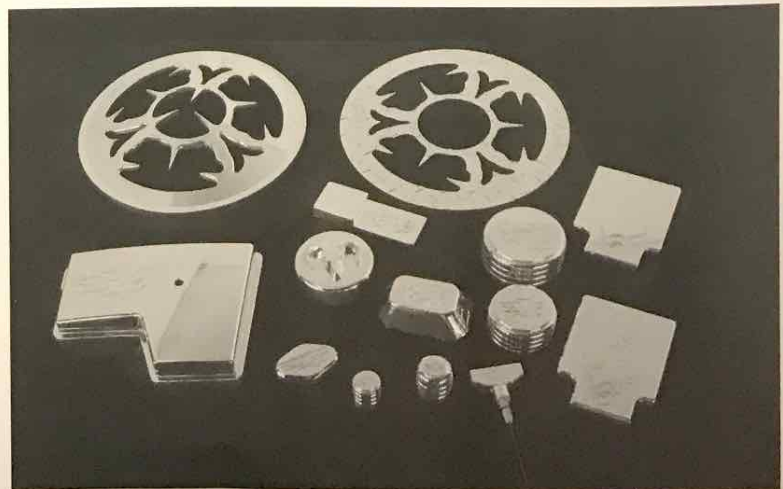

CUSTOM BILLET INTERIOR & ENGINE DRESS UP KITS

ACCESSORIES

WHEELS

WHAT IS THE DIFFERENCE IN OUR WHEEL STYLES AND WHY ARE THE PRICES SO DIFFERENT?

First, all wheels by Colorado Custom are manufactured with the same high quality. No exception. Colorado Custom Billet Series, the same high quality but it takes less time to machine and polish these styles. They are two-dimensional machined style wheels. Less time manufacturing our Billet Series wheels produces a more affordable wheel. Second, we have our S/S Series and T&B Series. The manufacturing time of these two series increases with longer milling cycles and labor intensive polishing creating wheels at a higher cost. The two series involve 2-3 dimensional machining. These wheels give our customer a top of the line wheel. Third, Colorado Customs' Lock Down Series wheels are all complex 3-dimensional machined wheels with the longest machine cycle times as well as the longest polishing time, very labor intensive. The Lock Down Series debut was the 2003 SEMA show. They are a huge success for Colorado Custom. The prices are the highest as a 3-dimensional machined wheel bar none. Another debut at 2003 SEMA show was a new idea in wheel building. Colorado Customs' new T & A series combines titanium and aluminum giving the wheels a new two-tone appearance. The T&A series is way over the top as the most unique wheel on the market. This series is for the person who wants to set the bar a little higher on their ride. T & A wheels are Colorado Customs' most expensive wheels. These wheels involve the highest machining, polishing & assembly of any wheel on the scene today. We believe the T & A series is a big winner for very the high end-user. Colorado Customs' Single Piece Series (SPS) wheels are available in 20 x 8.5 with a 5.0 backspace and 22 x 9 with a 5.5 backspace. Our SPS wheels are available polished or chrome. This series is for the SUV and Truck market.

WHAT IS THE DIFFERENCE BETWEEN A TWO-PIECE AND SINGLE PIECE WHEEL?

Note that item number one explains a two-piece wheel. The one-piece wheel is most common to the average consumer. Most cars, trucks and sport utility vehicles are driving on a one-piece OEM wheel. The one-piece wheel is most commonly made from an aluminum casting [specification A356]. This casting type is cheap. Cast wheels will not polish to a high luster. Paint, powder coat and shot peen surfaces are used to disguise the poor finish on a cast wheel. Colorado Customs' one-piece forged aluminum wheels [specification 6061T6] are a high quality finished wheels. The restriction of a one-piece wheel is the backspace. There is no adjusting the backspace of a one-piece wheel. Our customers are able to get a quality chrome or high luster polished finish in our one-piece line.

WHAT DO WE RECOMMEND FOR MAINTAINING THE POLISHED FINISH ON OUR WHEELS?

First, we recommend you pressure wash your wheels. Second, wipe off wheels with a very soft rag such as a baby diaper. Third, a product like Windex with out ammonia works very well to maintain the luster in the wheels. Fourth, use an all billet aluminum non-abrasive polish when needed. Fifth, use the non-ammonia Windex to remove the polish residue.

WHAT IS THE LEAD-TIME TO BUILD A SET OF COLORADO CUSTOM WHEELS?

This will vary a small amount do to the current volume of business and material companies delivering on time. The usual lead-time is 3-6 weeks. Representatives of Colorado Custom should call to verify current ETA's so we can give you the best delivery time for your customer. In most cases we ship steering wheels 1-5 days after an order is placed but again call so we can give you an ETA.

WHAT IS THE DIFFERENCE BETWEEN A SOFT AND STANDARD HOOP?

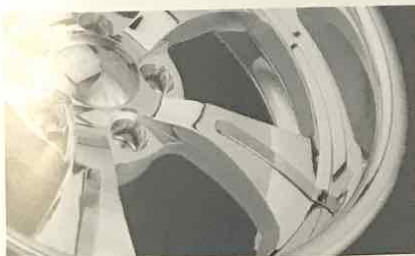

Soft Lip



Standard Lip

STEERING WHEELS

WHAT IS THE SIZE OF A COLORADO CUSTOM STEERING WHEEL?

We have three sizes a 14.0, 16.5 and 18.5. The 14.0 diameter wheel comes in all our designs. There are limited designs in the 16.5 and 18.5 diameters. Please see our 2004 price guide for the available designs in 16.5 and 18.5. This will take care of automobiles, trucks, hotrods and customs.

WHAT HUBS DO YOU OFFER?

We offer only a GM hub adapter at this time. There are a number of companies that build steering columns for the car enthusiast such as Flaming River and Ididit. These companies will use our 67-94-hub adaptor. For applications other than GM, the customer can purchase a hub from LeCarrea, but it must be a 9-bolt set up.

COLORADO CUSTOM FC LIMITED WARRANTY

Colorado Custom Wheels are warranted for a period of one year from the date of purchase to be free of defects in materials and workmanship to the original purchaser only. Warranty adjustments require sales invoice for verification of date of purchase. Oxidation or corrosion of the finish that are due to neglect and/or adverse weather or chemicals is not covered by this warranty.

Colorado Custom FC, in the event of a defect, malfunction or failure to conform with this limited warranty, (upon return and inspection of the wheel(s)) will repair, or replace and return the product through the authorized distributor to the customer. We assume no responsibility for diagnosis, removal, and installation labor, loss of vehicle use, loss of time, inconvenience or other incidental or consequential expense, whether arising out of breach of contract, breach of warranty or otherwise. Some states do not allow the exclusion or limitation of incidental or consequential damages so the above limitations or exclusion may not apply to you.

Important: All defective returns will be reviewed by quality control personnel and any defects not found to be Colorado Custom's responsibility will be rejected and returned to the sender at their expense.

The following procedure should be followed if a problem arises with a Colorado Custom wheel:

1. Take your receipt and wheel(s) to the dealer where you purchased the wheel(s).
2. Show your dealer the receipt and the wheel(s) in question and explain the problem.
3. The dealer will contact Colorado Custom FC, and will be issued RGA #. The RGA# and description of the problem needs to be included in the box with the return of the wheel.
4. If you do not receive satisfaction from the dealer, within reasonable period of time, contact or write: Colorado Custom FC, 363 Jefferson Street, Suite 101, Fort Collins, Colorado 80524, Attn: Customer Service Department. Phone 970-224-5750

The following are not covered by this warranty:

1. Damage to the surface finish of the wheel or accessory as result of stone chips or similar road hazards.
2. Damage to the surface finish of the wheel or accessory as a result of the use of polish, abrasives or rubbing compound or the use of acid base cleaners.

THIS WARRANTY IS VOID IF:

1. Wheels have been damaged in transit by misuse, abuse, accident or negligence, or have been repaired or altered by anyone other than Colorado Custom FC. This would include but not limited to plating, painting, anodizing, or clear coating the wheels.
2. Wheels have not been installed according to instructions.
3. Tires have been mounted on the wheels before checking fit on the vehicle
4. Wheels are used for off road driving or racing.

This warranty gives you specific legal rights, and you may also have other rights, which vary from state to state.

TERMS AND POLICIES

TERMS: All orders will be subject to a 75% deposit, the balance due will be paid at the time of shipping, either by credit card or COD. Any checks returned "NSF" will be subject to a \$30 penalty fee, and status of the account changed to Certified Funds. Open account Net 30 terms will be based on sales volume, and past history with Colorado Custom.

Displays: All displays will be priced at 50% off jobber.

Orders: All orders will be placed via fax or mail. No verbal orders will be accepted at any time. Each order should be on company form, with a purchase order number, signature, and credit card number if applicable.

Returns: Any and all returns are subject to approval from Colorado Custom. Each return will be on a case-by-case basis. No credit will be issued before Colorado Custom has first inspected the product. All returns must be issued a RGA number prior to shipment. Colorado custom reserves the right to refuse to issue credit on any item returned without proper documentation.

Freight: All orders will be shipped F.O.B. Ft. Collins, CO

Delivery Time: COLORADO CUSTOM can give an estimated scheduled time of delivery, but cannot guarantee exact delivery.

PLEASE FEEL FREE TO CONTACT OUR TECHNICAL/SALE SUPPORT IF THERE ARE ANY QUESTIONS ON ANY OF THE GIVEN INFORMATION.