

OFFICE
LIGHTING
AND
ACOUSTIC
PANELS



01502 507347

karboxx

A close-up photograph of cotton bolls on a branch, with the text "OFFICE LIGHTING AND ACOUSTIC PANELS" overlaid in white. The cotton bolls are white and fluffy, with some brown, dried leaves still attached to the stems. The background is a soft, out-of-focus blue sky. The text is positioned in the upper left quadrant of the image.

OFFICE
LIGHTING
AND
ACOUSTIC
PANELS

SOURCE OF DESIGN

From Karboxx's experience with research, high-tech and minimal design applied to indoor lighting, we have developed our range of office lighting. This is a new collection based on LED technology, designed to illuminate working spaces with attention to the needs of professional environments and corporate offices.

Karboxx communicates an advanced concept of lighting design that takes care of both the physical and emotional wellbeing of workers by stimulating creativity, encouraging levels of concentration while positively influencing the style of working environments.

SORGENTE DI DESIGN

Dall'esperienza Karboxx nella ricerca, tecnologia e design minimal applicato all'interpretazione della luce per interni, è nata la linea di illuminazione ufficio. Si tratta di una nuova collezione basata sulla tecnologia a LED, progettate ad hoc per l'illuminazione dell'ambiente lavorativo, con un'attenzione peculiare alle esigenze degli studi professionali, di uffici operativi e direzionali di pregio. Karboxx irradia un concetto evoluto di light design che si prende cura del benessere fisico ed emotivo di chi lavora, stimolando la creatività, favorendo la concentrazione e caratterizzando con coerenza lo stile degli ambienti.

LIGHT UP YOUR OFFICE

FLOOR
— 4. FLY
12. MORE
20. MINISTICK

DESK
— 28. MINISTICK 2.0
36. MICROSTICK

PENDANT
— 44. EUSTRESS
54. FLYUP

ACOUSTIC SOLUTIONS
— 64. LIGHTSOUND



FLOOR
FLY
DESIGN_MORENO DE GIORGIO

Maximum efficiency and space usability, Fly is the ideal solution for work spaces requiring lightness and elegant functionality. Fly is based both on advanced concept and LED illuminating material. The flowing design of elements, with minimal and smoothed profiles, hides a sophisticated device of perimetral injection light, applied to a specific methacrilate that spreads and deviates the light flow perpendicularly towards the surface to be illuminated. Fly introduces an aerodynamic silhouette designed for achieving both the comfort and performance.

Massima efficienza e fruibilità dello spazio, Fly è la soluzione ideale per ambiti di lavoro che richiedono leggerezza ed elegante funzionalità. Fly si basa su avanzati concept e materiali dell'illuminotecnica a Led. Il design fluido degli elementi, con profili minimi e levigati, nasconde un sofisticato dispositivo ad iniezione luminosa perimetrale, applicato ad un particolare metacrilato di ultima generazione che diffonde e devia il flusso luminoso perpendicolarmente alla superficie da illuminare. Fly presenta una silhouette aerodinamica progettata per il comfort e la performance.





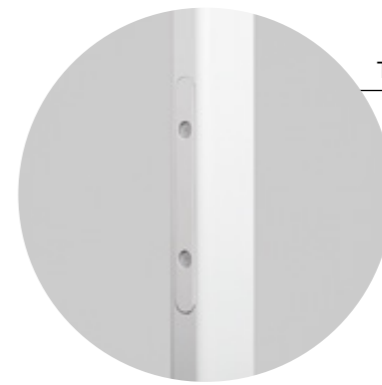

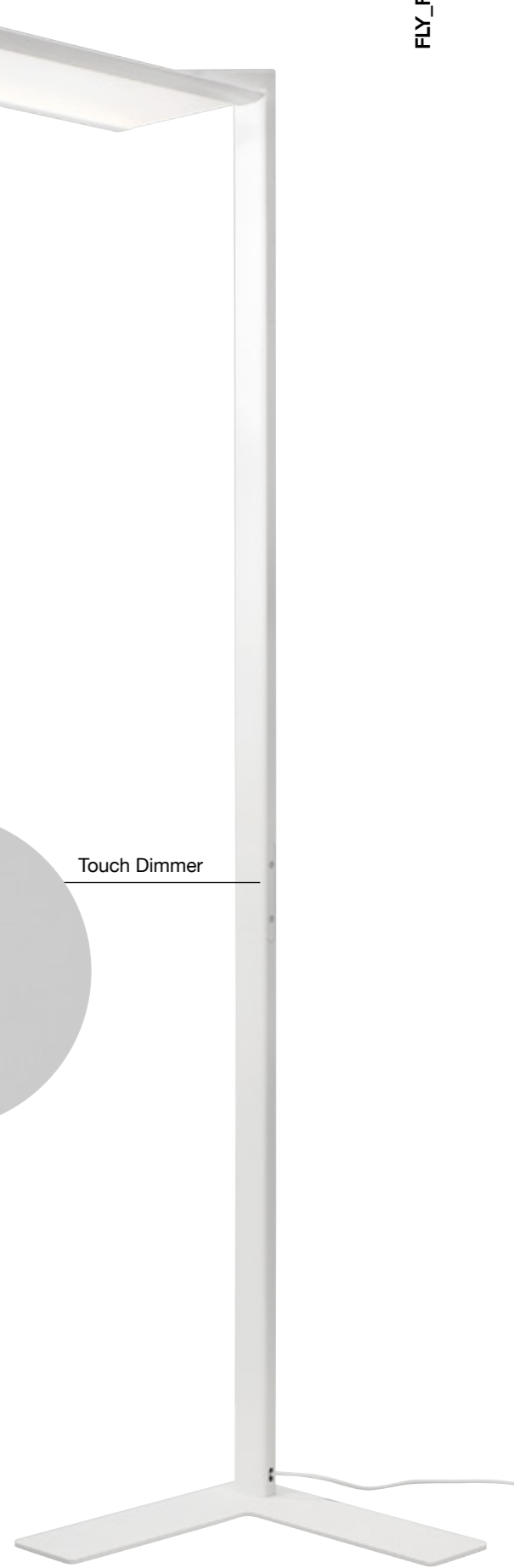

Touch Dimmer

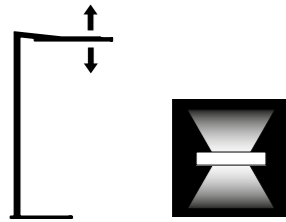
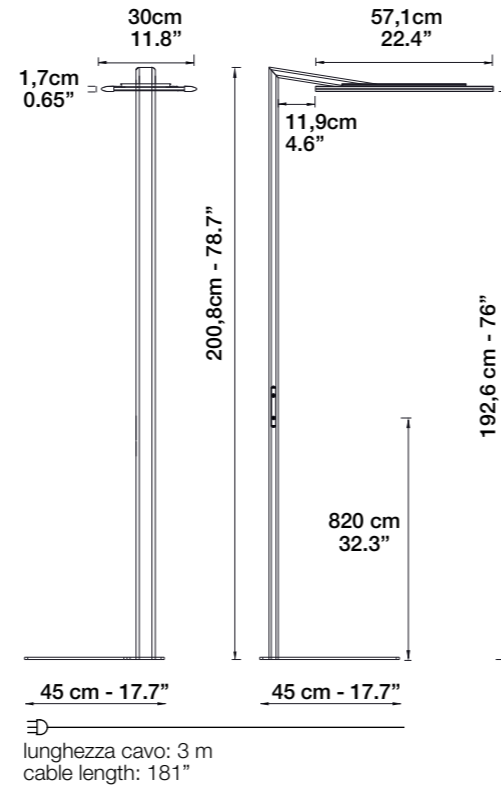

FLY

FLOOR_TECHNICAL DESCRIPTION

**LED** CE IP20 □

Description	Floor lamp - Aluminium luminaire and stem. Metal base.
Voltage - Control	110-240V 50-60Hz "Touch Dimmer" sensor 0-100% with separated control (up and down light). Plug: Europlug, type C - Cable lenght: 3m
Light Source	LED 3000K CRI90 (4000K on demand), UGR <19
Light Emission	Lower diffuser: HR methacrylate + high efficiency prismatic methacrylate Upper diffuser: opal methacrylate
Options	3 versions with different flux: - Fly 8 - 8400lm (4400lm direct and 4000lm indirect) = 70W - Fly 12 - 11400lm (4400lm direct and 7000lm indirect) = 91W - Fly 16 - 16400lm (4400lm direct and 12000lm indirect) = 130W UK plug - USA plug
Finishes	Structure: textured painted white RAL 9016 

FLY_FLOOR



FLOOR MORE

DESIGN_MORENO DE GIORGIO

More is the iconic result of a defined typology of lamp in the office lighting that shows the evolution of both design and technology. More seeks performance and pleasantness for the contemporary office with a compact and architectural design with a reduced visual impact made of simplicity and essentially.

More presence, close to work stations, is unique and delicate thanks to its proportions of logic, power and linearity. Nothing is redundant, all is functional and defined in every detail. More is made of high standard components: state-of-the-art led, touch controls, micro-prismatic diffuser and aluminum extruded profiles. More recalls the attention to the elegance of shapes achieved by the technological evolution, for a pleasant office.

More è l'originale risultato di una tipologia formale corretta nell'office lighting, nella quale l'evoluzione della forma si rinnova nella costante ricerca di tecnologia e design applicato ai materiali. More ricerca prestazione e gradevolezza per l'ufficio contemporaneo, con un design compatto e architettonico a ridotto impatto visivo, fatto di semplicità, essenzialità e cura del dettaglio. Logica, potenza, linearità in nuove e inedite proporzioni rendono More una presenza unica e discreta accanto ai tavoli di lavoro. Nulla è superfluo, tutto è funzionale e curato in ogni minima scelta. More è dotata di componenti ad elevato standard: Led performanti di ultima generazione, comandi touch, diffusore microprismatico, profili estrusi in alluminio. L'immagine di More richiama l'attenzione all'eleganza delle forme che l'evoluzione tecnologica consente, per un ufficio soft e gradevole.



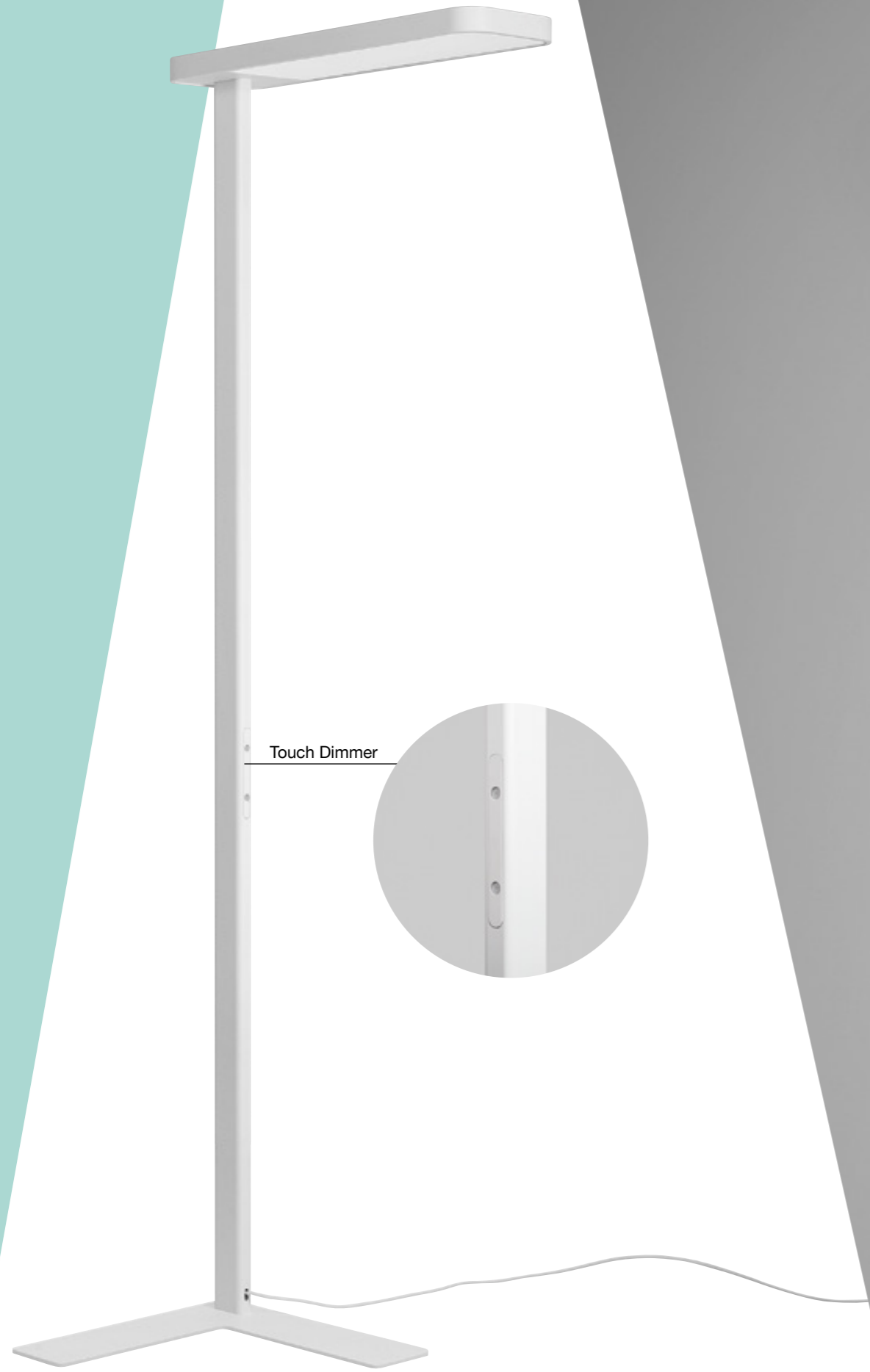

Touch Dimmer



MORE

FLOOR_TECHNICAL DESCRIPTION

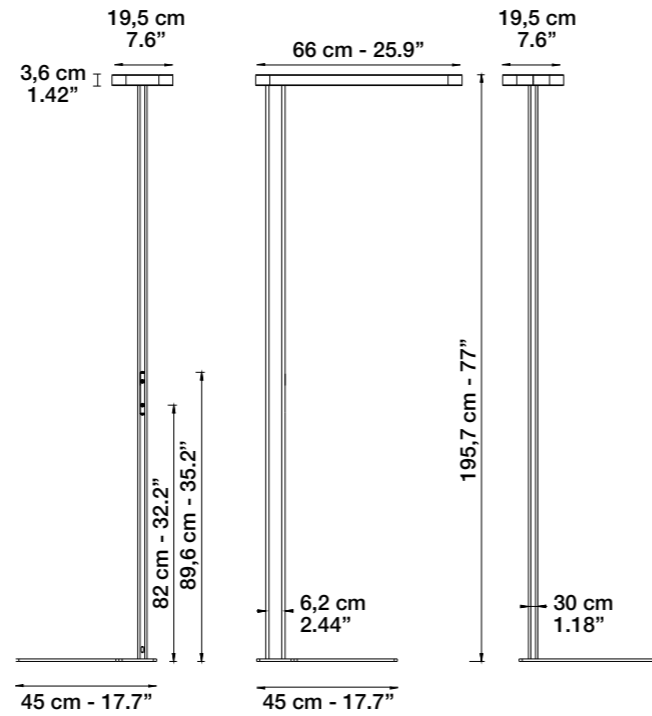

⊕
lunghezza cavo: 3 m
cable length: 181"

LED CE IP20 □

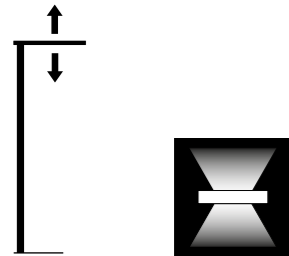

Description	Floor lamp - Aluminium luminaire and stem. Metal base.
Voltage - Control	110-240V 50-60Hz "Touch Dimmer" sensor 0-100% with separated control (up and down light) Plug: Europlug, type C - Cable length: 3m
Light Source	LED 3000K CRI90 (4000K on demand), UGR <19
Light Emission	Lower diffuser: high efficiency prismatic methacrylate Upper diffuser: opal methacrylate
Options	3 versions with different flux: - More 8 8000lm (4000lm direct and 4000lm indirect) = 64W - More 12 12000lm (4000lm direct and 8000lm indirect) = 94W - More 16 16000lm (4000lm direct and 12000lm indirect) = 124W UK plug - USA plug
Finishes	Structure: textured painted white RAL 9016 



MINISTICK

DESIGN_MORENO DE GIORGIO

FLOOR

MiniStick was created to deliver maximum flexibility and comfort for the user. The floor lamp fascinates you with its elegance obtained with a simple yet effective design. Technological versatility and aesthetic beauty join together in this unique object; hiding a million different configurations behind its design.

MiniStick è stata ideata per garantire la massima duttilità e confort nel suo utilizzo. La versione da terra affascina per la sua eleganza ottenuta grazie ad un design semplice ma dal carattere forte. Versatilità tecnologica e bellezza estetica si incontrano in questo oggetto unico che dietro al suo design nasconde un mondo di configurazioni diverse.



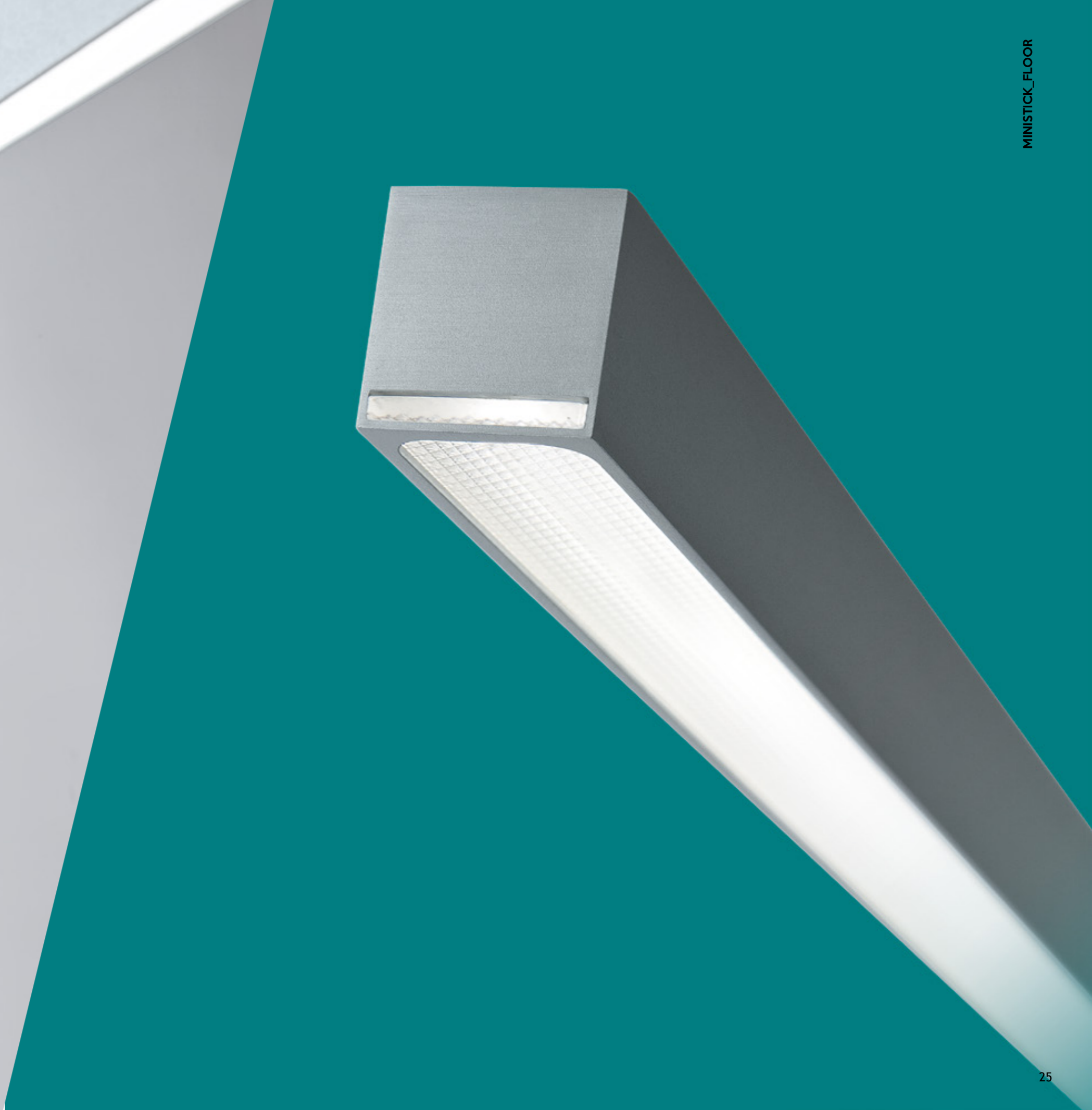

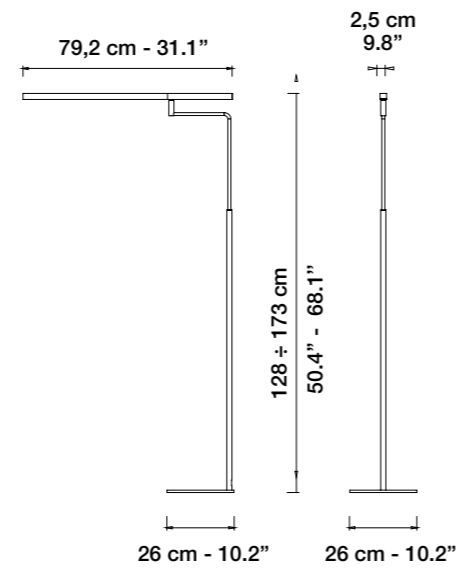

MINISTICK

FLOOR_TECHNICAL DESCRIPTION



LED CE IP20

Description	Floor lamp - Aluminium luminaire and structure in metal base.	
Voltage - Control	Electronic power supplier 230V Luminous flux 1300 lm Switch ON/OFF 50% > 100%	
Light Source	15W LED - 3000K - CRI=80	
Light Emission	Diffuser: high efficiency prismatic methacrylate	
Options	UK plug - USA plug	
Finishes	Luminaire: anodized aluminium	Structure: white painted RAL 9016, or anthracite painted RAL 7022
		 



DESK

MINISTICK 2.0

DESIGN_MORENO DE GIORGIO

MiniStick was conceived to deliver maximum flexibility and comfort for the user. The desktop lamp captivates you with its elegance obtained with a simple yet effective design. The high-efficiency prismatic diffuser and the possibility to adjust the lamp according to specific needs are key features for the office environment

MiniStick è stata ideata per garantire la massima duttilità e confort nel suo utilizzo. La versione da scrivania affascina per la sua eleganza ottenuta grazie ad un design semplice ma dal carattere forte. Il diffusore microprismatico ad alta efficienza e la possibilità di regolare la posizione della lampada rende questo prodotto specialmente adatto per l'ambiente ufficio.



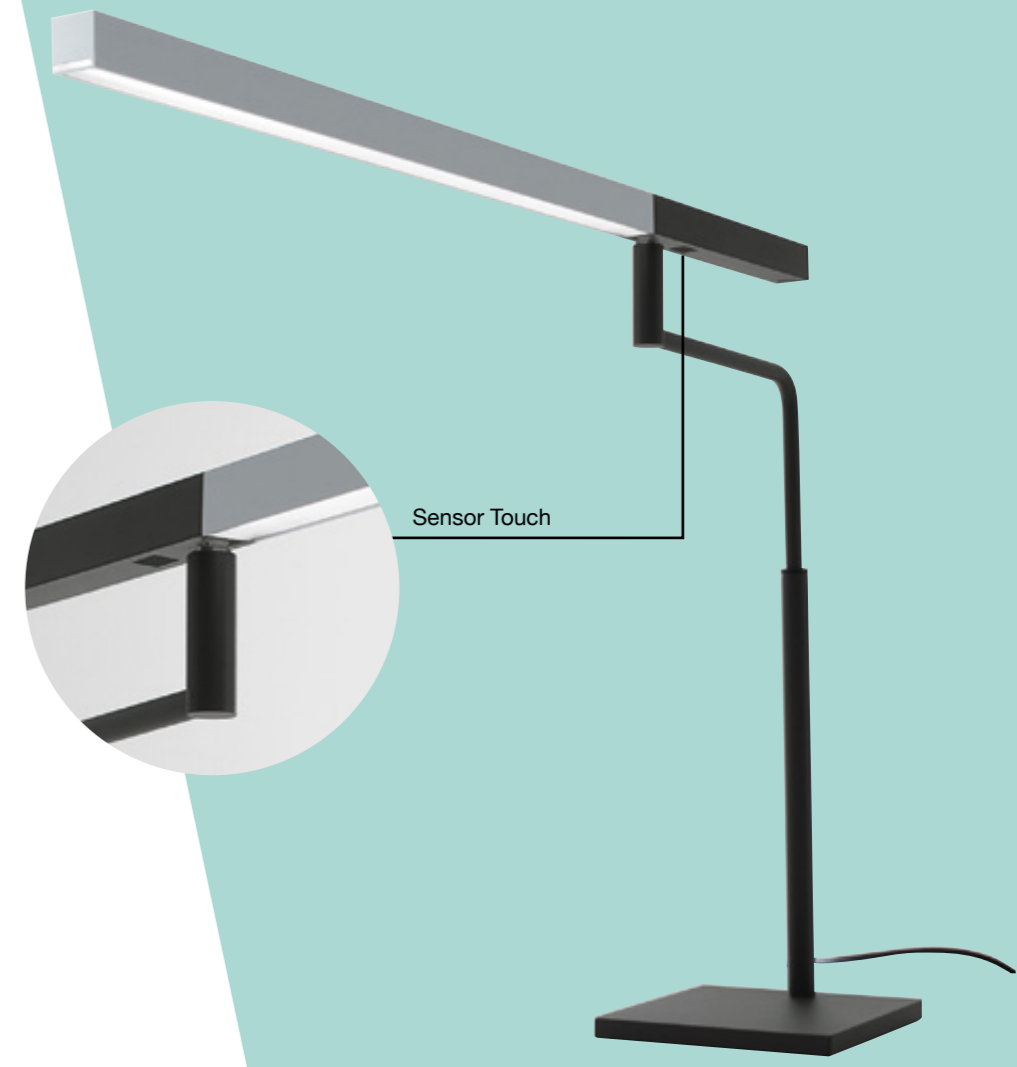



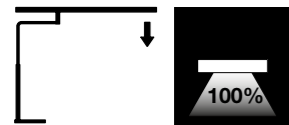
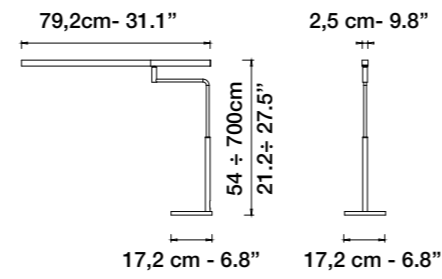

MINISTICK 2.0

DESK_TECHNICAL DESCRIPTION



LED CE IP20

Description	Table lamp - Aluminium luminaire head and structure in metal.	
Voltage - Control	110-240V 50-60Hz "Touch Dimmer" sensor 0-100% Electronic power supplier 230V Luminous flux 1300 lm	
Light Source	15W LED - 3000K - CRI=80	
Light Emission	Diffuser: high efficiency prismatic methacrylate	
Finishes	Luminaire: anodized aluminium	Structure: white painted RAL 9016, or anthracite painted RAL 7022 black painted RAL 9005, red painted RAL 3000
		   

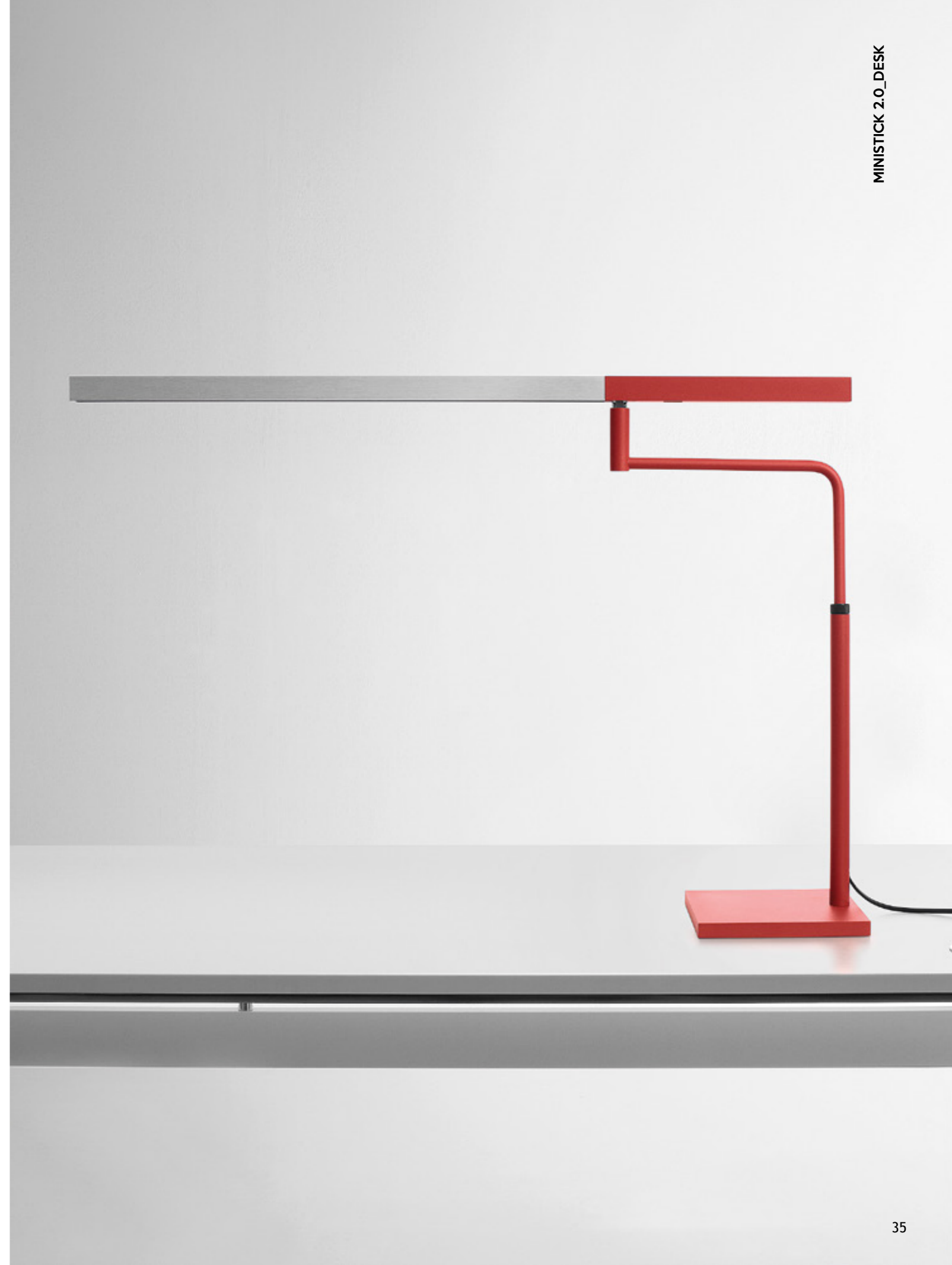

MicroStick is a smart desk lamp on a simple and compact aluminum body. The 10W LED light source provides a soft, comfortable light, with no strong contrasts. A special touch sensor with dimmer function is used to switch the lamp on/off and to adjust the brightness. MicroStick is available in white and silver. The perfect lamp for your desk, at home or in your office.

MicroStick è una lampada da studio semplice, minimale e compatta. La fonte luminosa LED da 10W emana una luce soft e senza contrasti, ma allo stesso tempo efficiente e funzionale. Uno speciale sensore touch con funzioni dimmer permette di accendere e spegnere, regolandone la potenza di illuminazione. Disponibile nelle finiture bianco e alluminio, MicroStick è la lampada perfetta da tavolo o scrivania, a casa o in ufficio.

MICROSTICK

DESIGN_MORENO DE GIORGIO

DESK







MICROSTICK

DESK_TECHNICAL DESCRIPTION

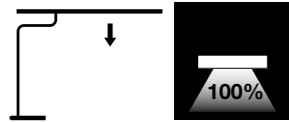
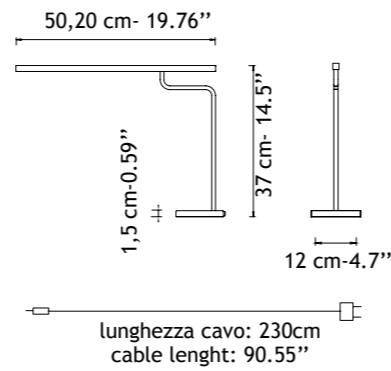

LED CE IP20

Description	Desk/Table lamp - Aluminium luminaire head and base metal.
Voltage - Control	110-240V 50-60Hz "Touch Dimmer" sensor 0-100%. Luminous flux 800 lm
Light Source	10W LED - 4000K Electronic feeder
Light Emission	Diffuser: opal methacrylate
Finishes	Structure: painted white RAL 9010 Silver-grey RAL 9006 Black RAL 9005 Cable and plug: white or black color



SUSPENDED EUSTRESS

DESIGN_MORENO DE GIORGIO

Eustress pendant lamp brings a new shape to office lighting combining a high efficiency microprismatic diffuser and latest LED technology. Its essential yet intense design gives a modern and unconventional twist to the lamp thanks to its aluminium extrusion with a trapezoidal shape.

Eustress dà spazio a una nuova forma di illuminazione ufficio grazie al diffusore microprismatico ad alta efficienza e al LED di ultima generazione. La sua forma essenziale, ma definita grazie all'estruso di alluminio di forma trapezoidale, conferisce all'ambiente uno stile moderno e anticonformista.



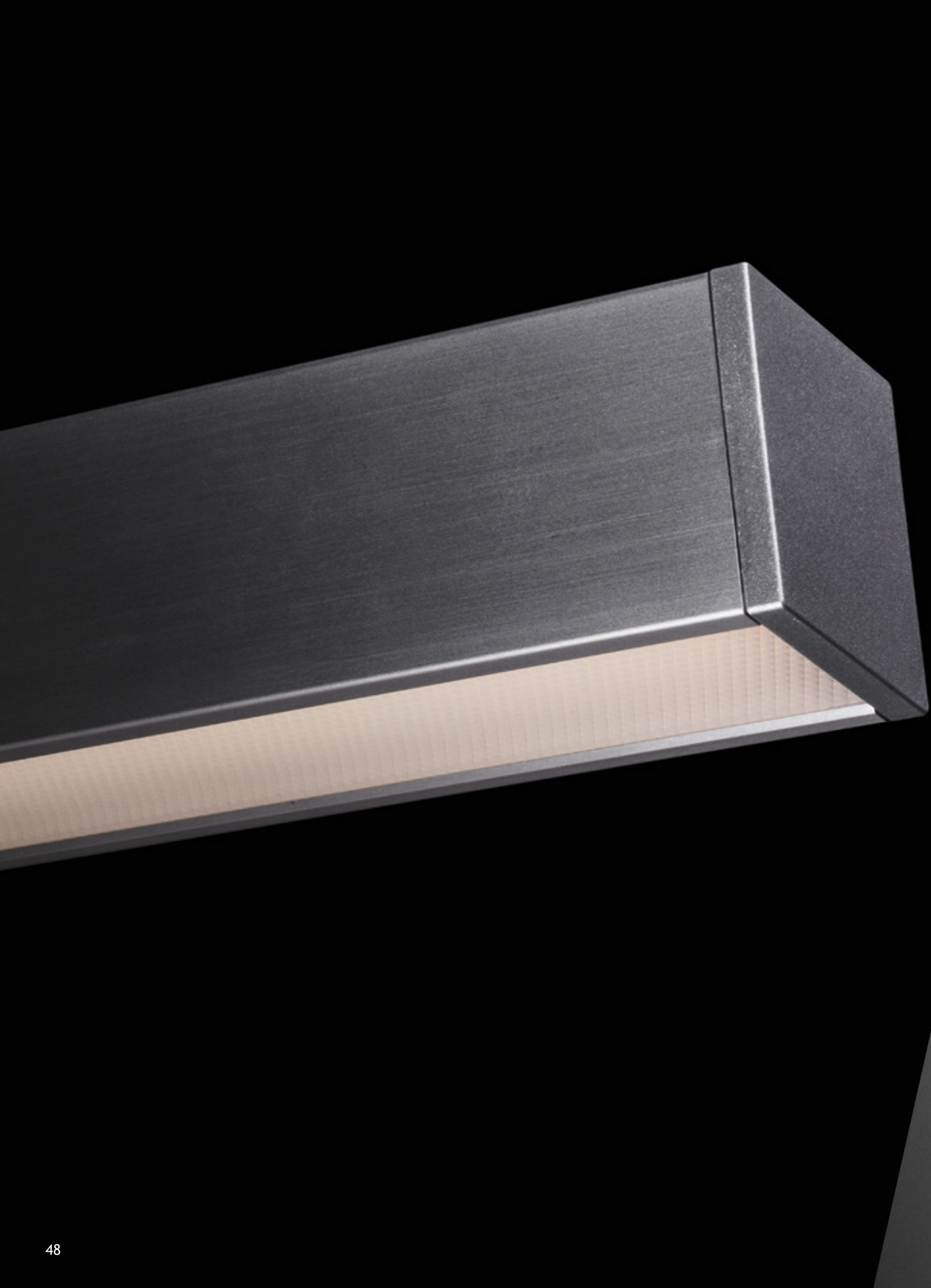



EUSTRESS

PENDANT_TECHNICAL DESCRIPTION

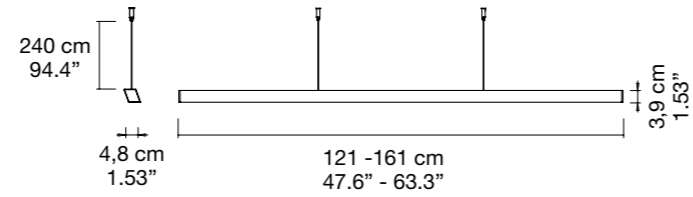

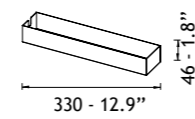

1. ON/OFF

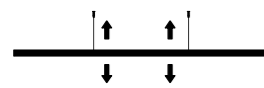
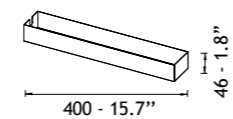

2. DIMMABLE



LED CE IP20

Description	Linear lamp in aluminium rhomboid section profiles with PMMA diffuser
Voltage - Control	Tension: 220-240V and 110-120V Control: ON/OFF
Light Source	LED 3000K CRI 80 - 1200 Direct (50%) and indirect (50%) light: 57W 4800lm - 1600 Direct (50%) and indirect (50%) light: 76W 6400lm UGR<19
Light Emission	Diffuser: opal microprismatic high efficiency PMMA
Finishes	Structure: anodized aluminium 
Options	- Dimmer - Length customized on demand - Ceiling rose: white RAL 9016 painted 



DESIGN MORENO DE GIORGIO

FLYUP

SUSPENDED

Flyup has a minimal design well suited to enlighten modern environments. The pure and elegant white structure gives this lamp a refined touch, easily adapting to the surroundings. Warm LEDs and an opal diffuser will give the surroundings a stylish "light" touch.

Linee pure e minimali caratterizzano FlyUp, sospensione adatta a illuminare ambienti che presentano una forte impronta di stile e di design. La struttura bianca e sottile permette di inserirsi in maniera delicata nei diversi spazi, non vuole infatti essere una presenza prorompente. Essenzialità e puntualità della luce grazie ad avanzati concept e Led.







FLYUP

PENDANT_TECHNICAL DESCRIPTION

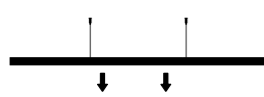
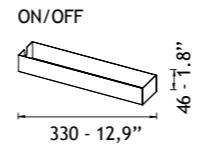
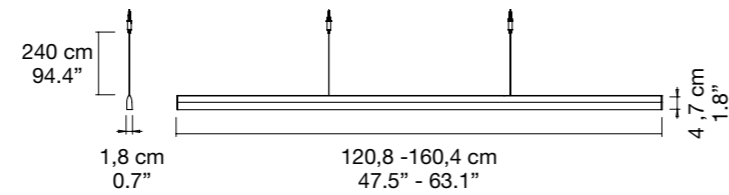

LED CE IP20

Description	Linear lamp in aluminium profiles with PMMA diffuser
Voltage - Control	Tension: 220-240V and 110-120V Control: ON/OFF
Light Source	LED 3000K CRI 80 - 1200 Direct light: 28W 2400lm - 1600 Direct light: 38W 3200lm UGR<19
Light Emission	Diffuser: opal PMMA
Finishes	Structure: anodized aluminium white painted RAL 9016
Options	- Length customized on demand - Ceiling rose: white RAL 9016 painted

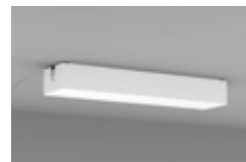

ACOUSTIC SOLUTIONS

LIGHTSOUND

DESIGN_MORENO DE GIORGIO



Designing the space to streamline work and ensure a dynamic and efficient environment through functional solutions and by being attentive to the well-being of the person.

LightSound is a system that has been created to meet the acoustic and visual comfort needs, and to create a wellness space in the professional world. Over the years, the fusion between architecture and wellness has an ever increasing presence, for this, work environments must be able to transmit professionalism and harmony.

The human factor and technology are the basic components for the creation of contemporary work spaces.

This product intervenes to create the right lighting and acoustics by reducing noise and, at the same time, perfectly illuminating the area.

The office wellness becomes one of the most important elements of the design. The world of work merges with hospitality, perception and comfort.

Progettare lo spazio per razionalizzare il lavoro e garantire un ambiente dinamico ed efficiente attraverso soluzioni funzionali e attente al benessere della persona. LightSound è un sistema che nasce per rispondere alle esigenze di comfort acustico e visivo, e per creare uno spazio wellness nel mondo professionale. Negli anni la contaminazione tra architettura e benessere è sempre più presente, per questo motivo gli ambienti di lavoro devono essere in grado di comunicare sia professionalità sia armonia.

Il fattore umano e tecnologia sono i componenti di base per la creazione degli spazi di lavoro contemporanei. Questo prodotto interviene per creare una corretta illuminazione e acustica attenuando il rumore e contemporaneamente illuminando in maniera puntuale l'ambiente.

L'office Wellness diventa uno degli elementi più importanti nella progettazione: il mondo del lavoro si fonde con l'ospitalità, la sensorialità e il comfort.





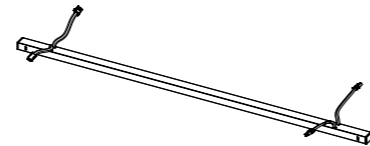

LIGHT ELEMENTS
EASY
 PENDANT_TECHNICAL DESCRIPTION



LED CE IP20



Description	Pendant light fitting consisting of an aluminium profile with plastic caps and a high efficiency microprismatic diffuser. To be used solely in combination with the LightSound triangular sound-absorbing panel. With a single driver, up to a maximum of 6 lamps can be powered.	
Voltage - Control	Tension: 220-240V and 110-120V Control: ON/OFF	
Light Source	LED 15W 1200lm 3000K CRI 80 UGR<19	
Light Emission	Diffuser: high efficiency micro-prismatic opal PMMA.	
Finishes	Structure: anodised aluminium and grey plastic caps.	Connections: Transparent lead and black terminals.
		
Options	<ul style="list-style-type: none"> - Universal canopy painted RAL9016 white Surcharge for 110V - Cable 100 cm - Ceiling rose: white RAL 9016 painted 	

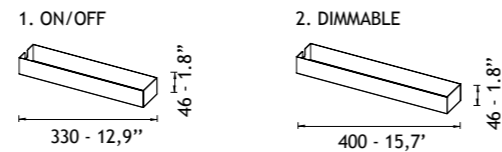
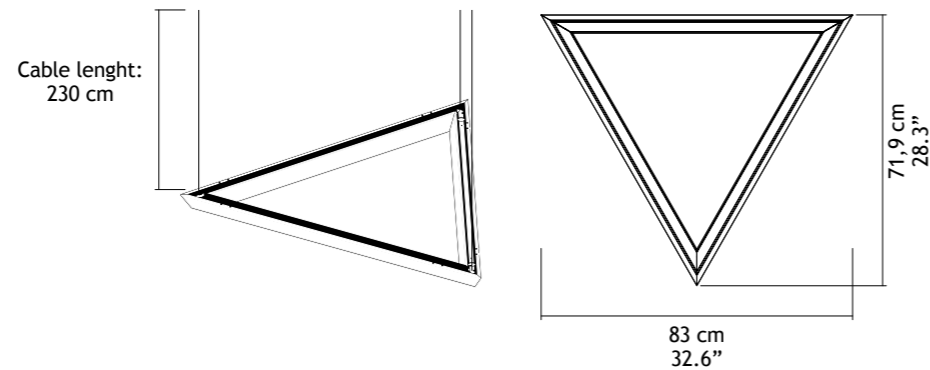
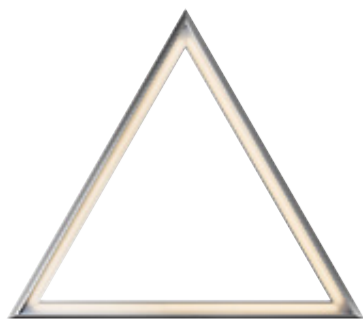

LIGHT ELEMENTS
TRIANGLE
 PENDANT_TECHNICAL DESCRIPTION



LED CE IP20

Description	Triangular light fitting with aluminium profiles and high efficiency micro-prismatic diffusers. Can be combined to form a composition with LightSound triangular sound-absorbing panels.	
Voltage - Control	Tension: 240V and 110V (upon request) Control: ON/OFF	
Light Source	LED 15W 1200lm 3000K CRI 80	
Light Emission	LED 3000K CRI 80 - Down light: 50W 4200lm - Down (56%) and up light (44%): 90W 7500lm UGR<19	
Finishes	Structure: silver anodised aluminium. 	
Options	<ul style="list-style-type: none"> - Universal canopy painted RAL9016 white - 240V dimmable - 110V dimmable - Surcharge for 110V - Linking kit to LightSound panels - Structure white RAL 9016 painted 	<ul style="list-style-type: none"> - Ceiling rose: white RAL 9016 painted 







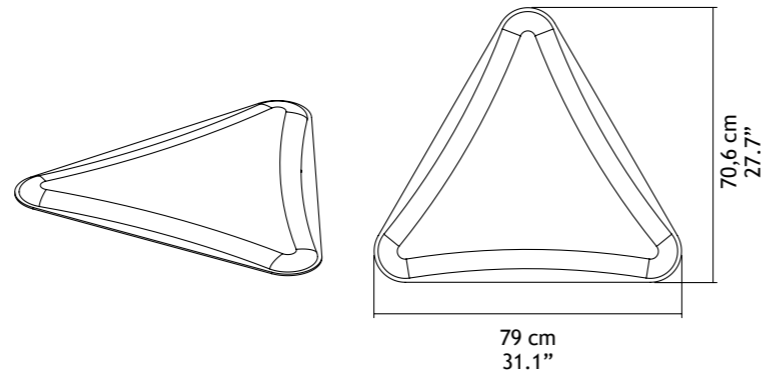





ACOUSTIC ELEMENT CLOAK

PENDANT/WALL/CEILING_TECHNICAL DESCRIPTION



Description	Triangular pendant/wall/ceiling-mounted acoustic panel. In the pendant version, it can be combined with the Triangle and Easy lamps from the LightSound collection.
Sound-absorbing	Surface area: - 0,35 M2 (wall-/ceiling) - 0,70 M2 (pendant)
Composition	Internal composition: polyester fibre. Outer covering: TreviraCS fabric in various colours.
Structure	Plastic hooks for the cable or for wall-/ceiling-mounting placed on the corners.
Fabrics	 <p>B01/009* B01/013* B01/019* B01/012* B01/018 B01/011 B01/023 B01/222 * colors available from stock</p> <p>5 weeks production lead time for fabrics not on stock. B01 fabrics which do not show are available on request (5 unit minimum order)</p>

	Class 1 Curtains and Drapes
	OEKO TEX N. 072150.O
	M1
	BS 5852 Crib N°5 using a CM Foam 35 Kg/cu.m.
	B1 DIN 4102
	1021 Part 1-2 using a CM Foam 35 Kg/cu.m.
	Calif. Bull. 117, Section E, Part I

	Q1 (OENORM 3800 PART 1)
	B1 (OENORM B 3825)
	Azimut serie Mirage
	IMO RES.A. 688(17)-Bedding Components
	IMO RES.A. 563(14)-Draperies, Curtains
	IMO RES.A. 653(16)-Surface Materials and Floor Covering
	IMO Res.A.652(16) FTP Code MSC 61 (67) Annex 1 Part 8 - Flame Retardant, polyurethane flexible foam, nominal density 35Kg/mq. in class 1 IM according to UNI 9175 supplied by the Laboratory.



MULTIFUNCTIONAL DESIGN

CONFIGURATIONS

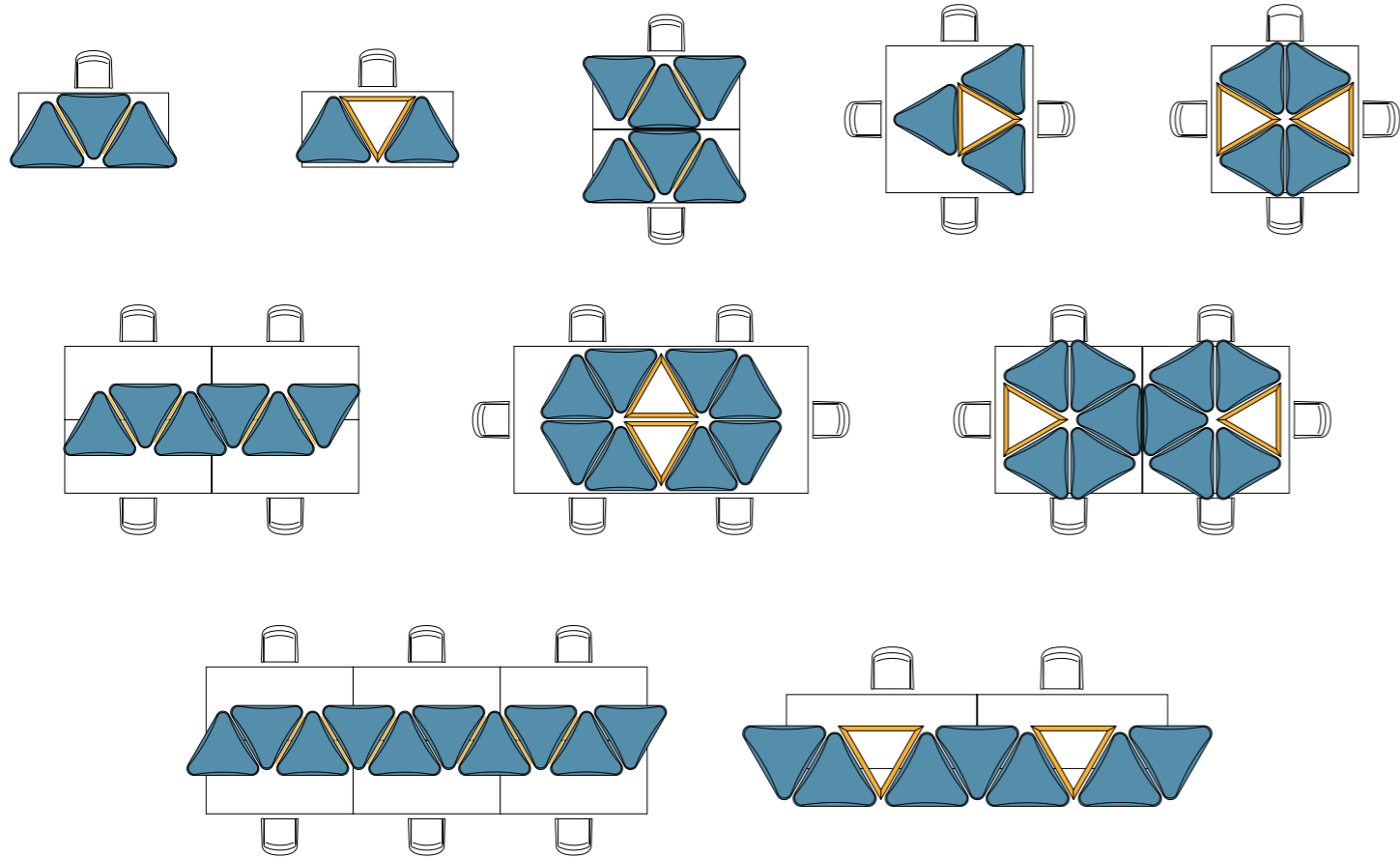

FUNCTIONAL AND AESTHETIC BALANCE

Modularity	The three LightSound modules, with their self-supporting and simple locking system, allow for infinite combinations and forms.
Soft Adjustment	LightSound is able to intervene in areas with visual-acoustic needs without having to require structural changes.
Visual Coherence	The system uses the same B01 fabric folder as the other The Quadrifoglio Group products, which allows for a perfect match among them.
Integrated Comfort	The LightSound system's characteristics perform optimally both for lighting and acoustics.
Area Adaptability	The minimal design allows for the system to be inserted in different areas whether it is hanging or wall mounted, or in an office or a hotel.



CODES

FLY

DESIGN_MORENO DE GIORGIO



CODE	DESCRIPTION	DESCRIZIONE
N7TR13-TW	Fly Floor 8 White 8400 lm - 70W	Fly Terra 8 Bianca 8400 lm - 70W
N7TR12-TW	Fly Floor 12 White 11400 lm - 91W	Fly Terra 12 Bianca 11400 lm - 91W
N7TR11-TW	Fly Floor 16 White 16400 lm - 130W	Fly Terra 16 Bianca 16400 lm - 130W

MORE

DESIGN_MORENO DE GIORGIO

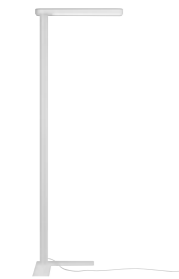

CODE	DESCRIPTION	DESCRIZIONE
N6TR13-TW	More Floor 8 White 8000 lm - 64W	More Terra 8 Bianca 8000 lm - 64W
N6TR12-TW	More Floor 12 White 12000 lm - 94W	More Terra 12 Bianca 12000 lm - 94W
N6TR11-TW	More Floor 16 White 16000 lm - 124W	More Terra 16 Bianca 16000 lm - 124W

MINISTICK

DESIGN_MORENO DE GIORGIO



CODE	DESCRIPTION	DESCRIZIONE
N3TR1LN-G	MiniStick Terra LED 15W Antracite	MiniStick Floor LED 15W Anthracite
N3TR1LN-W	MiniStick Terra LED 15W Bianca	MiniStick Floor LED 15W White

MINISTICK 2.0 DESK

DESIGN_MORENO DE GIORGIO



CODE	DESCRIPTION	DESCRIZIONE
N3TV3LN-B	MiniStick Desk LED 2.0 15W Black	MiniStick Tavolo LED 2.0 15W Nera
N3TV3LN-G	MiniStick Desk LED 2.0 15W Anthracite	MiniStick Tavolo LED 2.0 15W Antracite
N3TV3LN-R	MiniStick Desk LED 2.0 15W Red	MiniStick Tavolo LED 2.0 15W Rossa
N3TV3LN-W	MiniStick Desk LED 2.0 15W White	MiniStick Tavolo LED 2.0 15W Bianca

MICROSTICK

DESIGN_MORENO DE GIORGIO



CODE	DESCRIPTION	DESCRIZIONE
N4TV1LN-B	MicroStick LED 10W Black	MicroStick LED 10W Nera
N4TV1LN-G	MicroStick LED 10W Silver-Grey	MicroStick LED 10W Grigio-argento
N4TV1LN-W	MicroStick LED 10W White	MicroStick LED 10W Bianca

EUSTRESS

DESIGN_MORENO DE GIORGIO



CODE	DESCRIPTION	DESCRIZIONE
N9SPL2	Eustress Pendant 1200 - 56W - 2400+2400 lm	Eustress Sospensione 1200 - 56W - 2400+2400 lm
N9SPL1	Eustress Pendant 1600 - 76W - 3200+3200 lm	Eustress Sospensione 1600 - 76W - 3200+3200 lm

Code	Options	Opzioni
-	Ceiling Rose	Rosone
-	Ceiling Rose for dimmable lamp	Rosone per lampada dimmerabile
-	Surcharge for 1200-110V	Maggiorazione 1200-110V
-	Surcharge for 1600-110V	Maggiorazione 1600 - 110V
-	Dimmer	Dimmer

FLYUP

DESIGN_MORENO DE GIORGIO



CODE	DESCRIPTION	DESCRIZIONE
N7SPL2	Flyup Pendant 1200 - 28W - 2400 lm	Flyup Sospensione 1200 - 28W - 2400 lm
N7SPL1	Flyup Pendant 1600 - 38W - 3200 lm	Flyup Sospensione 1600 - 38W - 3200 lm

Code	Options	Opzioni
-	Ceiling Rose	Rosone
-	Surcharge for 110V	Maggiorazione 110V



CODE	EASY - DESCRIPTION	EASY - DESCRIZIONE
N8SPL1	Easy lamp 15W - 1200lm	Lampada Easy 15W - 1200 lm
N8SPK1	240V power supply kit - 3 lamps	Kit alimentazione 240V - 3 lampade
N8SPK2	240V power supply kit - 6 lamps	Kit alimentazione 240V - 6 lampade
N8SPA001	Extension lead	Prolunga cavo di alimentazione

Code	Easy - Options	Easy - Options
-	Universal canopy painted RAL9016 white	Rosone universale vern. bianco RAL9016
-	Surcharge for 110V	Maggiorazione 110V



CODE	TRIANGLE - DESCRIPTION	TRIANGLE - DESCRIZIONE
N8SPL2	Triangle lamp 240V - down light	Lampada Triangle 240V - luce diretta
N8SPL3	Triangle lamp 240V - down and up light	Lampada Triangle 240V - luce diretta+indiretta
N8SPA003	Linking kit to Cloak panel	Kit giunzioni Triangle - pannello Cloak

CODE	TRIANGLE - OPTIONS	TRIANGLE - OPZIONI
-	Universal canopy painted RAL9016 white	Rosone universale vern. bianco RAL9016
-	240V dimmable	Dimmerabile 240V
-	Surcharge for 110V	Maggiorazione 110V
-	110V dimmable	Dimmerabile 110 V
-	Profiles painted RAL9016 white	Profili vern. bianco RAL9016



CODE	CLOAK - DESCRIPTION	CLOAK - DESCRIZIONE
N8PAP001	Triangular wall-/ceiling-mounted panel	Pannello triangolare a parete/soffitto
N8SPP001	Triangular pendant panel	Pannello triangolare a sospensione
N8SPA002	Panel-panel linkig kit	Kit giunzioni pannello-pannello

CODE	CLOAK - OPTIONS	CLOAK - OPZIONI
-	B01 fabrics which do not show are available on request, 5 unit minimum order.	I tessuti B01 che non sono elencati sono disponibili su richiesta, ordine minimo di 5 unità.



* colors available from stock
Production lead time for non-stock colors:
5 weeks exclusive of delivery time

* colori disponibili a stock.
Per tessuti non a stock tempi di produzione 5 settimane.

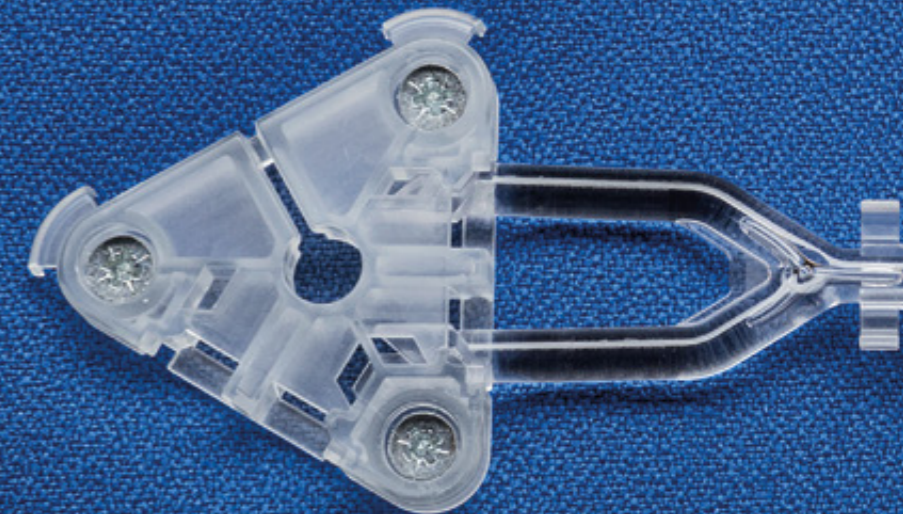

You might also be interested in...

Take a look at our range of products in the specialized catalogues in order to complete your project.

Per completare il tuo progetto dai uno sguardo a tutto il nostro ventaglio prodotti che potrai trovare nei cataloghi dedicati.



Blonde
Decorative Lighting

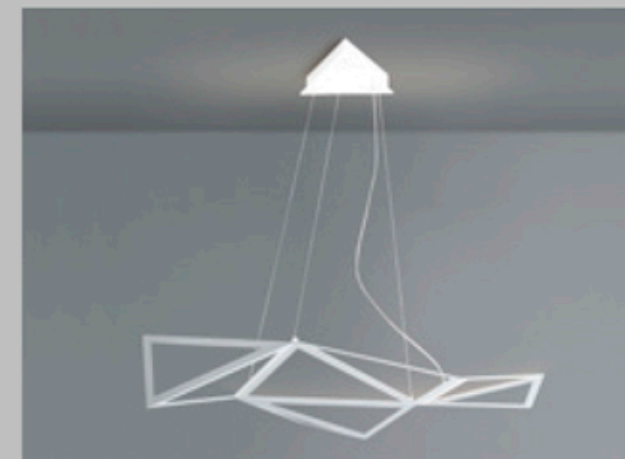

Starlight
Decorative Lighting



Escape Wall
Decorative Lighting



Ola
Decorative Lighting



Balance
Decorative Lighting



Babel Floor
Decorative Lighting

Photo and Graphics:
wearenative.it

Print:
gfpprinting.com
September 2018 - Ed. 01
LIKOLC01



Technical and aesthetical details, finishes or other product features can be modified without notification.
Particolari tecnici, estetici, finiture o altro possono essere modificati senza preavviso.

KARBOXX S.R.L.
Società Unipersonale
Via Cornarè, 12 • Basalghelle
31040 Mansuè (TV) • Italy

www.karboxx.com
info@karboxx.com

