





Decades in the making.

At Summit, we believe thoughtfully-made furniture should be for everyone. We design and build beautiful, affordable furniture that brings everyday spaces to life - from welcoming workplaces to inspiring campuses. Blending tradition with innovation, our pieces are made to stand the test of time.



Where heritage meets innovation

Founded by Peter Ford and Tom Simpson in 1977, Summit's reputation for quality design and service is decades in the making. From the tubular-framed and swivel chairs of the 1970s to the modular sofas and meeting booths for today, we've continuously innovated to make new collections that deliver on style, function, ergonomics and price.



Committed to a sustainable future

All of our furniture is tested to meet British standards for safety and durability, which means they achieve the highest levels of strength, reliability and stability. We also offer a comprehensive 5-year warranty for your peace of mind.

The height of quality British craftsmanship

From sourcing sustainable raw materials to making recyclable products, we're committed to working in a way that matches our social and environmental principles. As a member of FIRA's Furniture Industry Sustainability Programme, we're accountable for meeting the highest standards for safe, ethical, and sustainable practices.





Contents

SEATING

- 13** Task chairs
- 23** Visitor chairs
- 30** Meeting & Breakout chairs
- 38** Stools

SOFT SEATING

- 43** Reception chairs
- 48** Armchairs & Sofas
- 51** Modular sofas
- 78** Booths
- 81** Poufs

TABLES

- 86** Coffee
- 89** Breakout
- 92** Meeting
- 95** Poseur

FUNCTIONAL

- 101** Swivel seating
- 104** Conference chairs
- 107** Visitor & Reception
- 112** Stools & Beam seating

ADDITIONAL INFORMATION

- 116** Electrics
- 118** Fabric bands
- 121** General terms
- 122** Terms & Conditions



Seating

TASK CHAIRS

VISITOR CHAIRS

MEETING & BREAKOUT CHAIRS

STOOLS

Mechanisms

All of our task chairs are designed to provide exceptional levels of support and adjustability, to minimise health risks associated with sedentary working, and to promote good back care. To this end they are fitted with one of the following mechanisms, indicated at the top of the pricing column.

The appearance of the mechanism is representative only and may differ slightly according to mechanism type.

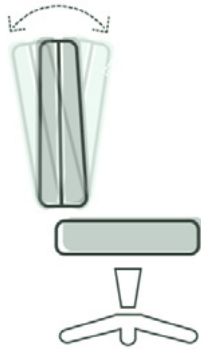

Operator

This mechanism has lever-operated, back angle adjustment that can be locked in any position or left unlocked to follow the user's movement in dynamic free float mode.

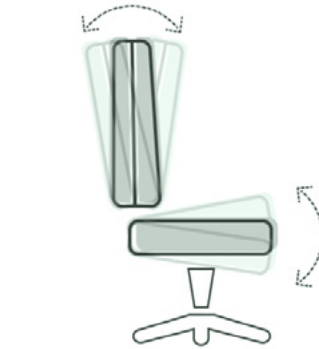

Operator Plus

Similar to the Operator mechanism but with additional lever-activated seat tilt adjustment. Where indicated, most Operator Plus mechanisms also include tension control to adjust for variation in user weight.

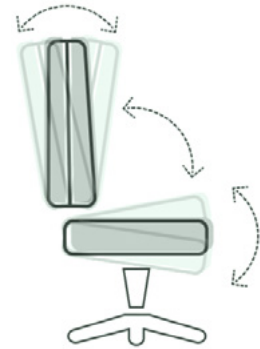

Operator Synchro

Back and seat recline together in a 2:1 ratio, can be locked in position or left in free-float mode to follow the user's dynamic movement. These chairs also have adjustable tension control.

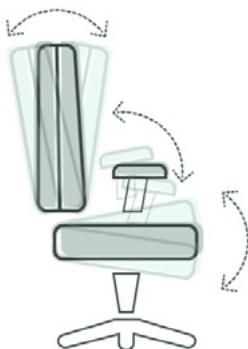

Synchro Plus

Combining the smooth operation of a synchronised mechanism, with the breadth of adjustability of an Operator Plus mechanism; the back angle can be adjusted independently of the synchronised seat and back recline.

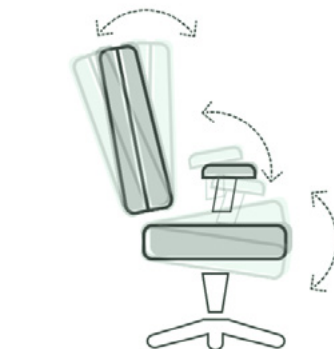

Body Balance Synchro



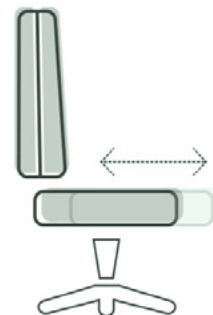



Back and seat recline in a 3:1 ratio. They can be locked in position or left in free-float mode to follow the user's dynamic movement. The mechanism automatically adjusts to body weight for individually tailored support.



Seat Slider

A seat slider allows the horizontal adjustment of the seat, offering increased leg support when required. This function is beneficial to accommodate differing seat depth requirements.

OPTIONAL ACCESSORIES

PRODUCT NAME	DESCRIPTION	RRP
Sundries		
Brake loaded castors 	Brake loaded castors in place of standard castors (<i>per set of 5</i>)	+£43
Soft wheeled castors 	Soft wheel castors in place of standard castors (<i>per set of 5</i>)	+£23
Glides 	Glides in place of standard castors	FOC
Draughtsman base 	Draughtsman base, footring and gas lift in place of standard base and gas lift. We do not recommend the fitment of draughtsman base to any swivel chair that has a Synchro or Operator Plus mechanism	+£67
High gas lift 	Draughtsman gas lift (380mm casing) in place of standard gas lift. We recommend the use of base with glides, not castors, in combination with this gas lift. We do not recommend the fitment of draughtsman gas lift to any swivel chair that has a Synchro or Operator Plus mechanism	+£32
Mid. height gas lift 	Mid. height gas lift (290mm casing) in place of standard gas lift, supplied with glides	+£30

Steel frame colour options

We have over 45 years' experience in manufacturing and finishing tubular steel furniture frames. We have a comprehensively equipped tube bending and welding facility and adjacent to this, a state of the art, epoxy powder coating plant. These combined assets bring lots of competitive benefits - bespoke frame variations, short lead times, multiple finish options.

The epoxy finishes shown here are available across a large proportion of our steel framed furniture ranges. In addition to these stock colours we can offer a colour matching service. The price for this is on application.

We also offer a Chrome Plate option on many products. The negative environmental impact of chromic acid and other aspects of the plating process make it one which we want to influence our customers to see as not only an undesirable choice but also unnecessary. We believe we can do this by offering a cost saving but aesthetically credible alternative. Our Bright Chrome Epoxy is a powder coating with a mirror bright finish that, seen in isolation is very hard to distinguish from chrome plate. Its visual appeal is equal to that of chromium plate.

METALLICS



Clear lacquer



Bright chrome epoxy



platinum

BLACK & WHITE



PASTEL COLOURS



Light Pink



Pastel Blue



Pastel Green



Ivory



Lilac

BRIGHT COLOURS



Red



Blue



Green



Yellow





Ochre







Orange

Seating

Task chairs





PRODUCT NAME	DESCRIPTION	DIMENSIONS/OPTIONS	FINISH	RRP	
E-Lite				Operator SCT160ADJ	Operator Plus SCT161ADJ
	Mesh back (7 colours - black, blue, green, grey, orange, red, white), Upholstered seat, Height adjustable arms, Back tilt (Operator) or Independent back & seat tilt (Operator Plus), Chair height adjustment, Black base	W: 680mm Seat (H): 450-560mm Seat (W): 510mm Seat (D): 480mm Back (H): 510mm	Band 0	£298	£321
			Band 1	£306	£329
			Band 2	£313	£336
			Band 3	£322	£345
			Band 4	£332	£355
			Band 5	£367	£390
			Band 6	£401	£424
	Options	Chair without arms: SCT160/ SCT161 W: 510mm	-£51		
			+£53		
			Folding height adjustable arms	+£20	
			Seat slider	+£42	
		Inflatable lumbar support	+£54		

Norton				Operator Synchro N12ADJ
	Black mesh back, Upholstered seat, Height adjustable armrests, Adjustable lumbar support, Multi-locking synchronous mechanism, Seat slide adjustment, Chair height adjustment, Black base	W: 700mm Seat (H): 475 - 595mm Seat (W): 510mm Seat (D): 455mm Back (H): 510mm	Black seat fabric	£357
			Band 0	£393
			Band 1	£402
			Band 2	£414
			Band 3	£424
			Band 4	£433
			Band 5	£469
			Band 6	£462



PRODUCT NAME	DESCRIPTION	DIMENSIONS/OPTIONS	FINISH	RRP
Ovair				Body Balance Synchro OV32ADJ
	Black mesh back, Upholstered seat, Height adjustable arms, Lumbar height adjustment, Push button controlled Body Balance Synchronised back & seat tilt, Chair height adjustment, Black base	W: 640mm Seat (H): 450mm - 550mm Seat (W): 490mm Seat (D): 455mm Back (H): 515mm	Band 0	£400
			Band 1	£410
			Band 2	£420
			Band 3	£432
			Band 4	£444
			Band 5	£490
			Band 6	£524
	Options	Chair without arms: OV32 W: 490mm		-£53
	Options	Polished aluminium base		+£85
			Seat slider	+£23
			Folding height adjustable arms	+£24



Arc				Body Balance Synchro ARCL19B/ARCL19G
	Black or Grey mesh back & seat, Integrated tilting mechanism, Weight sensitive, flexing movement automatically adjusting to the user's body, Chair height adjustment, Black base	W: 600mm Seat (H): 450mm - 550mm Seat (W): 500mm Seat (D): 430mm Back (H): 600mm	Black	£432
			Grey	



PRODUCT NAME	DESCRIPTION	DIMENSIONS/OPTIONS	FINISH	RRP	
Operator			Low back	Operator SCT4ADJ Operator Plus SCT41ADJ	
	Upholstered back & seat, Height adjustable arms, Back tilt (Operator) or Independent back & seat tilt (Operator Plus), Black base	W: 640mm Seat (H): 440-550mm Seat (W): 455mm Seat (D): 440mm Back (H): 430mm	Band 0	£186	£209
			Band 1	£197	£220
			Band 2	£208	£231
			Band 3	£222	£245
			Band 4	£236	£259
			Band 5	£289	£312
		Band 6	£329	£352	
		W: 640mm Seat (H): 440-550mm Seat (W): 455mm Seat (D): 440mm Back (H): 520mm	High back	Operator SCT5ADJ Operator Plus SCT51ADJ	Operator Plus SCT51ADJ
			Band 0	£200	£223
			Band 1	£213	£236
			Band 2	£226	£249
			Band 3	£242	£265
	Band 4		£258	£281	
	Band 5	£319	£342		
	Band 6	£366	£389		
	Options	Chair without arms: SCT4/SCT5 W: 455mm		-£45	
		Chair with loop arms: SCT4A/SCT5A W: 555mm		-£22	
		Polished aluminium base		+£53	
		Folding height adjustable arms		+£24	
		Seat slider		+£42	
		Inflatable lumbar support <i>(High back only)</i>		+£45	





PRODUCT NAME	DESCRIPTION	DIMENSIONS/OPTIONS	FINISH	RRP	
Tangent				Operator SCT20ADJ	Operator Plus SCT21ADJ
	Upholstered back & seat, Height adjustable arms, Ratchet back height adjustment, Back tilt (Operator) or Independent back & seat tilt (Operator Plus), Black base	W: 670mm Seat (H): 450-560mm Seat (W): 510mm Seat (D): 480mm Back (H): 480mm	Band 0	£261	£284
			Band 1	£274	£297
			Band 2	£287	£310
			Band 3	£304	£327
			Band 4	£320	£343
			Band 5	£381	£404
			Band 6	£428	£451
	Options	Chair without arms: SCT20/SCT21 W: 510mm	-£45		
			Polished aluminium base	+£53	
			Folding height adjustable arms	+£24	
			Seat slider	+£40	
		Inflatable lumbar support	+£45		





Blenheim				Operator Plus BL21ADJ	
	Upholstered back & seat, Height adjustable arms, Easy lift, back height adjustment, Inflatable lumbar, Independent back & seat tilt, Seat depth adjustment, Black base	W: 670mm Seat (H): 490-600mm Seat (W): 510mm Seat (D): 480mm Back (H): 520mm	Band 0	£385	
			Band 1	£398	
			Band 2	£412	
			Band 3	£429	
			Band 4	£446	
			Band 5	£511	
			Band 6	£558	
	Options	Chair without arms: BL21 W: 510mm	-£45		
			Polished aluminium base	+£53	
			Folding height adjustable arms	+£24	
			Width and height adjustable arms	+£30	







PRODUCT NAME	DESCRIPTION	DIMENSIONS/OPTIONS	FINISH	RRP	
Tiverton	 Upholstered back & seat, Height adjustable arms, Back tilt (Operator) or Independent back & seat tilt (Operator Plus), Black base  Certified to BS5459, safety and durability of task seating	W: 670mm Seat (H): 450-560mm Seat (W): 510mm Seat (D): 480mm Back (H): 520mm	High back		
			Operator T550ADJ	Operator Plus T551ADJ	
			Band 0	£318	£344
			Band 1	£331	£357
			Band 2	£345	£371
			Band 3	£362	£388
			Band 4	£379	£405
		Band 5	£443	£469	
		Band 6	£491	£517	
		Extra High back	Operator T990ADJ	Operator Plus T991ADJ	
		Band 0	£352	£378	
		Band 1	£367	£393	
		Band 2	£383	£409	
		Band 3	£402	£428	
Band 4	£422	£448			
Band 5	£496	£522			
Band 6	£550	£576			
 Chair without arms: T550/T551/T990/T991 W: 510mm				-£45	
	Options	Polished aluminium base		+£53	
		Folding height adjustable arms		+£24	
		Seat slider		+£40	



PRODUCT NAME	DESCRIPTION	DIMENSIONS/OPTIONS	FINISH	RRP
Inflexion				Operator Plus IF81ADJ
	Upholstered back & seat, Height adjustable arms, Easy-lift back height adjustment, Inflatable lumbar support, Independent back & seat tilt (Operator Plus), Black base	W: 660mm Seat (H): 460-560mm Seat (W): 530mm Seat (D): 500mm Back (H): 555mm	Band 0 Band 1 Band 2 Band 3 Band 4 Band 5 Band 6	£465 £491 £516 £547 £579 £699 £788
	Options	Chair without arms: IF81 W: 530mm		-£51
		Headrest: IF91/IF91ADJ Back (H): 730mm, Including headrest		+£94
		Polished aluminium base		+£85
		Folding height adjustable arms		+£13
		Seat slider		+£40
	Sliding arm pad		+£42	
	Memory foam seat		+£85	
	Coccyx cut-out		+£153	



PRODUCT NAME	DESCRIPTION	DIMENSIONS/OPTIONS	FINISH	RRP					
<h2>Ergonomic Task 24</h2>				Operator Plus					
						Round back SCT91ADJ	Square back SCT121ADJ		
					<p>Upholstered back & seat, Heavy duty height adjustable arms, Ratchet back height adjustment, Inflatable lumbar support, Independent Back & Seat tilt with tension control, Seat slider, Black base</p> <p>Guaranteed for 5 years whilst in 24 hour, heavy duty use. Perfect for call centre and other multi-user environments.</p>	<p>W: 650mm Seat (H): 480-590mm Seat (W): 530mm Seat (D): 500mm Back (H): 580mm (SCT91ADJ) Back (H): 560mm (SCT121ADJ)</p>	Band 0	£482	£489
							Band 1	£497	£504
							Band 2	£512	£519
							Band 3	£530	£537
							Band 4	£549	£556
Band 5	£619	£626							
Band 6	£671	£678							
	Options	<p>Chair without arms: SCT91/SCT121 W: 530mm</p>	-£64						
		<p>Headrest for square back version: SCT131/SCT131ADJ Back (H): 740mm, Including headrest</p>	+£114						
		<p>Polished aluminium base</p>	+£63						
		<p>Sliding arm pad</p>	+£42						
	<p>Memory foam seat</p>	+£85							
	<p>Coccyx cut-out</p>	+£153							







PRODUCT NAME	DESCRIPTION	DIMENSIONS/OPTIONS	FINISH	RRP
Sensit				Body Balance Synchro STA102ADJ
	Upholstered back & seat, 2D adjustable arms (width and height), Push button back height adjustment, Body Balance Synchro mechanism for effortless recline, Air care seat - dual, adjustable air cells for constant support as you move, Inflatable lumbar support, Black base	W: 600-670mm Seat (H): 450-550mm Seat (W): 500mm Seat (D): 470mm Back (H): 520mm	Band 0 Band 1 Band 2 Band 3 Band 4 Band 5 Band 6	£569 £592 £616 £645 £674 £785 £866
	Options	Chair without arms: STA102 W: 500mm		-£71
		Headrest: STA202/STA202ADJ Back (H): 800mm, Including headrest		+£119
		Polished aluminium base		+£85
		Folding height adjustable arms, no width adjustment		+£19
		Seat slider		+£22
	Coccyx cut-out		+£153	



PRODUCT NAME	DESCRIPTION	DIMENSIONS/OPTIONS	FINISH	RRP
Posturemax 200				Synchro Plus PHL73ADJ
	Upholstered memory foam back & seat, 2D adjustable armrests (width and height), Ratchet back height adjustment, Synchro Plus mechanism with side tension adjustment and anti-kick safety feature, Inflatable lumbar support, Seat depth adjustment, Black aluminium base Guaranteed for 5 years. Users up to 200Kg in weight.	W: 640mm Seat (H): 505-635mm Seat (W): 505mm Seat (D): 470mm Back (H): 550mm	Band 0	£1,529
			Band 1	£1,564
			Band 2	£1,598
			Band 3	£1,642
			Band 4	£1,685
			Band 5	£1,850
			Band 6	£1,971
		Chair without arms: PHL73 W: 505mm		-£121
	Options	Headrest: PHL83/PHL83ADJ Back (H): 760mm, Including headrest		+£136
		Sliding arm pad		+£42
		Variable contour back		+£126
		Extra large seat: + 60mm Width + 30mm Depth		+£123
		Coccyx cut-out		+£153



Seating

Visitor chairs



PRODUCT NAME	DESCRIPTION	DIMENSIONS/OPTIONS	FINISH	RRP
E-Lite				SCTEX160
	Mesh back (7 colours - black, blue, green, grey, orange, red, white), Upholstered seat, Black cantilever frame	W: 620mm D: 640mm Seat (H): 490mm Seat (W): 510mm Seat (D): 480mm Back (H): 500mm	Band 0	£350
			Band 1	£357
			Band 2	£364
			Band 3	£373
			Band 4	£383
			Band 5	£418
			Band 6	£452
	Options	Chair without arms: SCTC160 W: 540mm	-£83	
			Non standard frame colour (MOQ 5 units)	+£13

Ovair				4-leg OV40A	Cantilever OV50A
 	Black mesh back, Upholstered seat, Black cantilever or 4-leg frame	W: 600mm D: 570mm Seat (H): 455mm Seat (W): 505mm Seat (D): 460mm Back (H): 460mm	Band 0	£373	£342
			Band 1	£383	£352
			Band 2	£393	£362
			Band 3	£405	£374
			Band 4	£417	£386
			Band 5	£463	£432
			Band 6	£497	£466
	Options	Chair without arms: OV40/OV50 W: 550mm	-£45		
			Non standard frame colour (MOQ 5 units)	+£13	



PRODUCT NAME	DESCRIPTION	DIMENSIONS/OPTIONS	FINISH	RRP	
Ovair				T Arm OVEX30	Tube Arm OVMA30
	Black mesh back, Upholstered seat, Lumbar support, Black cantilever frame	W: 630mm D: 580mm Seat (H): 500mm Seat (W): 490mm Seat (D): 455mm Back (H): 525mm	Band 0	£372	
			Band 1	£382	
			Band 2	£392	
			Band 3	£404	
			Band 4	£417	
			Band 5	£462	
			Band 6	£496	
	Options	Chair without arms: OVC30 W: 490mm D: 550mm Back (H): 540mm		-£83	
		Non standard frame colour (MOQ 5 units)		+£13	



PRODUCT NAME	DESCRIPTION	DIMENSIONS/OPTIONS	FINISH	RRP	
Operator				Low back SCTC4A	High back SCTC5A
	Upholstered back & seat, Loop arms, Black cantilever frame	W: 555mm D: 550mm Seat (H): 490mm Seat (W): 455mm Seat (D): 440mm Back (H): 350mm (SCTC4A) Back (H): 480mm (SCTC5A)	Band 0	£204	£218
			Band 1	£215	£231
			Band 2	£226	£244
			Band 3	£240	£260
			Band 4	£254	£276
			Band 5	£307	£337
			Band 6	£347	£384
	Options	Chair without arms: SCTC4/SCTC5 W: 540mm	-£23		
			Non standard frame colour (MOQ 5 units)	+£13	

Tangent				T Arm SCTEX20	
	Upholstered back & seat, Black cantilever frame	W: 620mm D: 640mm Seat (H): 490mm Seat(W): 510mm Seat (D): 480mm Back (H): 470mm	Band 0	£302	
			Band 1	£315	
			Band 2	£328	
			Band 3	£345	
			Band 4	£361	
			Band 5	£422	
			Band 6	£469	
	Options	Chair without arms: SCTC20 W: 540mm	-£83		
			Non standard frame colour (MOQ 5 units)	+£13	

PRODUCT NAME	DESCRIPTION	DIMENSIONS/OPTIONS	FINISH	RRP
Horizon				HZ30
	Upholstered back & seat, Black cantilever frame Stackable 4 high	W: 515mm D: 590mm Seat (H): 500mm Seat (W): 450mm Seat (D): 465mm Back (H): 380mm	Band 0	£302
			Band 1	£317
			Band 2	£331
			Band 3	£349
			Band 4	£368
			Band 5	£437
			Band 6	£488
	Options	Chrome plate frame	+£40	
			Non standard frame colour (MOQ 5 units)	+£13

Blenheim				T Arm BLEX20	Tube Arm BLMA20
	Upholstered back & seat, Black cantilever frame	W: 620mm D: 640mm Seat (H): 490mm Seat (W): 510mm Seat (D): 480mm Back (H): 480mm	Band 0	£318	
			Band 1	£331	
			Band 2	£345	
			Band 3	£362	
			Band 4	£379	
			Band 5	£444	
			Band 6	£491	
	Options	Chair without arms: BLC20 W: 540mm	-£83		
			Non standard frame colour (MOQ 5 units)	+£13	





PRODUCT NAME	DESCRIPTION	DIMENSIONS/OPTIONS	FINISH	RRP	
Tiverton				T Arm TEX550	Tube Arm TMA550
	High back, Upholstered back & seat, Black cantilever frame	W: 620mm D: 580mm Seat (H): 490mm Seat (W): 510mm Seat (D): 480mm Back (H): 470mm	Band 0	£336	
			Band 1	£349	
			Band 2	£363	
			Band 3	£380	
			Band 4	£397	
			Band 5	£461	
			Band 6	£509	
	Extra high back, Upholstered back & seat, Black cantilever frame	W: 620mm D: 580mm Seat (H): 490mm Seat(W): 510mm Seat (D): 480mm Back (H): 555mm	T Arm TEX990	Tube Arm TMA990	
			Band 0	£372	
			Band 1	£387	
			Band 2	£403	
			Band 3	£422	
			Band 4	£442	
			Band 5	£516	
Band 6	£570				
	Options	Chair without arms: TC550/ TC990 W: 540mm	-£83		
			Non standard frame colour (MOQ 5 units)	+£13	



PRODUCT NAME	DESCRIPTION	DIMENSIONS/OPTIONS	FINISH	RRP	
Sensit				T Arm STAEX100	Tube Arm STAMA100
	Upholstered back & seat, Black cantilever frame	W: 620mm D: 600mm Seat (H): 490mm Seat (W): 500mm Seat (D): 470mm Back (H): 520mm	Band 0	£419	
			Band 1	£442	
			Band 2	£466	
			Band 3	£495	
			Band 4	£524	
			Band 5	£635	
			Band 6	£716	
	Options	Chair without arms: STAC100 W: 500mm		-£83	
			Non standard frame colour (MOQ 5 units)	+£13	

Inflexion				T Arm IFEX80	Tube Arm IFMA80
	Upholstered back & seat, Black cantilever frame	W: 620mm D: 630mm Seat (H): 490mm Seat (W): 530mm Seat (D): 500mm Back (H): 550mm	Band 0	£443	
			Band 1	£469	
			Band 2	£494	
			Band 3	£525	
			Band 4	£557	
			Band 5	£677	
			Band 6	£766	
	Options	Chair without arms: IFC80 W: 540mm		-£83	
			Non standard frame colour (MOQ 5 units)	+£13	

Seating



*Meeting &
Breakout chairs*

PRODUCT NAME	DESCRIPTION	DIMENSIONS/OPTIONS	FINISH	RRP										
College														
CG40 	Stackable, Polypropylene shell, Chrome plated 4-leg frame Shell manufactured from 50% recycled materials			£114										
CG45 	Stackable, Polypropylene shell, Chrome plated skid frame Shell manufactured from 50% recycled materials			£133										
CG10 	Polypropylene shell, 4-leg wooden frame Shell manufactured from 50% recycled materials	W: 450mm D: 515mm Seat (H): 460mm Seat (W): 450mm Seat (D): 400mm Back (H): 430mm	Red, Lemon Yellow, Orange, Pale Blue, Green, Warm Grey	£137										
CG30 	Polypropylene shell, Chrome plated cantilever frame Shell manufactured from 50% recycled materials			£153										
	Options	Upholstered seat pad	<table border="1"> <tr><td>Band 0</td><td>+£29</td></tr> <tr><td>Band 1</td><td>+£38</td></tr> <tr><td>Band 2</td><td>+£45</td></tr> <tr><td>Band 3</td><td>+£55</td></tr> <tr><td>Band 4</td><td>+£65</td></tr> </table>	Band 0	+£29	Band 1	+£38	Band 2	+£45	Band 3	+£55	Band 4	+£65	
Band 0	+£29													
Band 1	+£38													
Band 2	+£45													
Band 3	+£55													
Band 4	+£65													

PRODUCT NAME	DESCRIPTION	DIMENSIONS/OPTIONS	FINISH	RRP
Modius				
	Stackable plastic chair, Integral linking, Chrome plated frame Tested to EN 16139 Level 2. Manufactured from recycled material and 100% recyclable (with appropriate choice of fabric)	W: 500mm D: 520mm Seat (H): 450mm Seat (W): 420mm Seat (D): 465mm Back (H): 380mm	Black MD1, Red MD5, Midnight Blue MD6, Anthracite MD7, Green MD8	£136
	Options	Upholstered seat pad	Band 0	+£43
			Band 1	+£50
			Band 2	+£58
			Band 3	+£68
			Band 4	+£78
		RH/LH writing tablet - chair no longer stackable		+£126
	Modius Trolley Capacity: 25x upholstered chairs 32x non-upholstered chairs	H: 380mm W: 610mm L: 720mm		£399

Ultra



	Stackable, 4-leg black frame	W: 590mm D: 515mm Seat (H): 500mm Seat (W): 435mm Seat (D): 400mm Back (H): 400mm	Band 0	£304
			Band 1	£324
			Band 2	£343
			Band 3	£367
			Band 4	£392
			Band 5	£484
			Band 6	£552
	Options	Chair without arms W: 485mm		-£24
			Non standard frame colour (MOQ 5 units)	+£13
			Chrome plate frame (MOQ 5 units)	+£45
			Soft arm pads	+£24

PRODUCT NAME	DESCRIPTION	DIMENSIONS/OPTIONS	FINISH	RRP
BonBon				
<p>G38BLK/G38NAS</p> 	<p>Veneer, 4-leg black base</p>	<p>W: 420mm D: 460mm Seat (H): 450mm Seat (W): 400mm Seat (D): 380mm Back (H): 400mm</p>	<p>Black ash</p> <hr/> <p>Natural ash</p>	<p>£225</p>
<p>G38UPH</p> 	<p>Upholstered, 4-leg black base</p>		<p>Band 0</p> <p>Band 1</p> <p>Band 2</p> <p>Band 3</p> <p>Band 4</p> <p>Band 5</p> <p>Band 6</p>	<p>£640</p> <p>£665</p> <p>£686</p> <p>£703</p> <p>£763</p> <p>£808</p> <p>£872</p>



PRODUCT NAME	DESCRIPTION	DIMENSIONS/OPTIONS	FINISH	RRP
Avebury				
AY10 	Black cantilever frame with arms	W: 600mm D: 570mm Seat (H): 460mm Seat (W): 420mm Seat (D): 440mm Back (H): 395mm	Band 0	£421
			Band 1	£455
			Band 2	£489
			Band 3	£531
			Band 4	£574
			Band 5	£736
			Band 6	£855
AY5 	Options	Chair without arms W: 550mm		-£46
			Non standard frame colour (MOQ 5 units)	+£13
			Non standard frame & arm colour (MOQ 5 units)	+£20
			Soft arm pads	+£24
			Chrome plate arms (MOQ 5 units)	+£40
			Chrome plate frame (MOQ 5 units)	+£60
AY15 	4-leg wooden frame	W: 550mm D: 570mm Seat (H): 460mm Seat (W): 420mm Seat (D): 440mm Back (H): 395mm	Band 0	£413
			Band 1	£447
			Band 2	£481
			Band 3	£523
			Band 4	£566
			Band 5	£728
			Band 6	£847
Options	Black wooden legs	+£24		
AY25 	5-star black swivel base, Gas lift and arms	W: 600mm D: 570mm Seat (H): 450-560mm Seat (W): 420mm Seat (D): 440mm Back (H): 395mm	Band 0	£399
			Band 1	£433
			Band 2	£467
			Band 3	£509
			Band 4	£552
			Band 5	£714
			Band 6	£833
AY20 	Options	Chair without arms W: 550mm		-£46
			Non standard arm colour (MOQ 5 units)	+£13
			Soft arm pads	+£24
			Chrome plate arms (MOQ 5 units)	+£40
			Tilt mechanism	+£50
			Polished 5-star swivel aluminium base	+£85

PRODUCT NAME	DESCRIPTION	DIMENSIONS/OPTIONS	FINISH	RRP
Avebury				
AY30 	4 star black pyramid swivel base with castors	W: 550mm D: 570mm Seat (H): 460mm Seat (W): 420mm Seat (D): 440mm Back (H): 395mm	Band 0	£408
			Band 1	£442
			Band 2	£476
			Band 3	£518
			Band 4	£561
			Band 5	£723
			Band 6	£842
Options	Polished 4-star aluminium base		+£85	

Scout

S010 	Green, Blue or Grey plastic shell, Black sled frame Shell 98% recyclable	W: 590mm D: 580mm Seat (H): 450mm Seat (W): 410mm Seat (D): 450mm Back (H): 365mm	Without cushion	£215
S020 	Green, Blue or Grey plastic shell, Upholstered cushion, Black sled frame Shell 98% recyclable	W: 590mm D: 580mm Seat (H): 470mm Seat (W): 410mm Seat (D): 450mm Back (H): 345mm	Band 0	£284
			Band 1	£294
			Band 2	£304
			Band 3	£316
			Band 4	£328
			Band 5	£374
			Band 6	£408
S025 	Fully upholstered, Black sled frame Shell 98% recyclable	W: 590mm D: 580mm Seat (H): 470mm Seat (W): 410mm Seat (D): 450mm Back (H): 345mm	Band 0	£486
			Band 1	£529
			Band 2	£572
			Band 3	£625
			Band 4	£679
			Band 5	£882
			Band 6	£1,032
Options	Non standard frame colour (MOQ 5 units)		+£13	



PRODUCT NAME	DESCRIPTION	DIMENSIONS/OPTIONS	FINISH	RRP
Scout				
S030 	Green, Blue or Grey plastic shell, Wooden leg frame Shell 98% recyclable	W: 590mm D: 600mm Seat (H): 460mm Seat (W): 410mm Seat (D): 450mm Back (H): 365mm	Without cushion	£267
S040 	Green, Blue or Grey plastic shell Upholstered cushion, Wooden leg frame Shell 98% recyclable	W: 590mm D: 600mm Seat (H): 480mm Seat (W): 410mm Seat (D): 450mm Back (H): 345mm	Band 0	£336
S045 	Fully Upholstered, Wooden leg frame Shell 98% recyclable		Band 1	£346
		Band 2	£356	
		Band 3	£368	
		Band 4	£380	
		Band 5	£426	
		Band 6	£460	
		Band 0	£538	
Band 1	£581			
Band 2	£624			
Band 3	£677			
Band 4	£731			
Band 5	£934			
Band 6	£1,084			
S050 	Green, Blue or Grey plastic shell, 5-star black height adjustable base Shell 98% recyclable	W: 590mm D: 610mm Seat (H): 390-500mm Seat (W): 410mm Seat (D): 450mm Back (H): 365mm	Without cushion	£190
S060 	Green, Blue or Grey plastic shell Upholstered cushion, 5-star black height adjustable base Shell 98% recyclable	W: 590mm D: 610mm Seat (H): 410-520mm Seat (W): 410mm Seat (D): 450mm Back (H): 345mm	Band 0	£259
S065 	Fully Upholstered, 5-star black height adjustable base Shell 98% recyclable		Band 1	£269
		Band 2	£279	
		Band 3	£291	
		Band 4	£303	
		Band 5	£349	
		Band 6	£383	
		Band 0	£461	
Band 1	£504			
Band 2	£547			
Band 3	£600			
Band 4	£654			
Band 5	£857			
Band 6	£1,007			
	Options	Polished 5-star swivel aluminium base		+£53



PRODUCT NAME	DESCRIPTION	DIMENSIONS/OPTIONS	FINISH	RRP
Scout				
S070 	Green, Blue or Grey plastic shell, 4-star black swivel base & castors Shell 98% recyclable	W: 590mm D: 600mm Seat (H): 410mm Seat (W): 410mm Seat (D): 450mm Back (H): 365mm	Without cushion	£272
S080 	Green, Blue or Grey plastic shell, Upholstered cushion, 4-star black swivel base & castors Shell 98% recyclable	W: 590mm D: 600mm Seat (H): 430mm Seat (W): 410mm Seat (D): 450mm Back (H): 345mm	Band 0	£341
S085 	Fully upholstered seat, 4-star black swivel base & castors Shell 98% recyclable		Band 1	£351
		Band 2	£361	
		Band 3	£373	
		Band 4	£385	
		Band 5	£431	
		Band 6	£465	
		Band 0	£543	
		Band 1	£586	
		Band 2	£629	
		Band 3	£682	
		Band 4	£736	
		Band 5	£939	
		Band 6	£1,089	
	Options	Polished 4-star swivel aluminium base		+£85

Seating

Stools

PRODUCT NAME	DESCRIPTION	DIMENSIONS/OPTIONS	FINISH	RRP
College				
CG20 	Plastic seat, Wooden frame Shell manufactured from 50% recycled materials	W: 450mm D: 515mm Seat (H): 785mm Seat (W): 450mm Seat (D): 400mm Back (H): 430mm	Red, Lemon Yellow, Orange, Pale Blue, Green or Warm Grey	£272
	Options	Upholstered seat pad	Band 0	+£29
			Band 1	+£38
			Band 2	+£45
			Band 3	+£55
			Band 4	+£65

Ultra			Low back UT21M-L	High back UT21M-H	
UT21M 	Stackable, Black high 4-leg frame	W: 485mm D: 535mm Seat (H): 795mm Seat (W): 435mm Seat (D): 400mm Back (H): 80mm (UT21M-L) Back (H): 400mm (UT21M-H)	Band 0	£262	£292
			Band 1	£274	£312
			Band 2	£286	£331
			Band 3	£300	£355
			Band 4	£315	£380
			Band 5	£370	£472
			Band 6	£411	£540
UT22M 	Stackable, Black high sled frame	W: 475mm D: 535mm Seat (H): 780mm Seat (W): 435mm Seat (D): 400mm Back (H): 80mm (UT22M-L) Back (H): 400mm (UT22M-H)		Low back UT22M-L	High back UT22M-H
			Band 0	£271	£301
			Band 1	£283	£321
			Band 2	£295	£340
			Band 3	£309	£364
			Band 4	£324	£389
			Band 5	£379	£481
			Band 6	£420	£549
	Options	Non standard frame colour (MOQ 5 units)	+£13		
		Chrome plate frame (MOQ 5 units)	+£60		

PRODUCT NAME	DESCRIPTION	DIMENSIONS/OPTIONS	FINISH	RRP
BonBon				
<p>G38BBLK/G38BNAS</p> 	<p>Veneer, Black sled frame</p>	<p>W: 450mm D: 530mm Seat (H): 750mm Seat (H): 770mm for UPH Seat (W): 400mm Seat (D): 340mm Back (H): 150mm</p>	Black ash	£275
			Natural ash	
<p>G38BUPH</p> 	<p>Upholstered, Black sled frame</p>		<p>Band 0</p> <p>Band 1</p> <p>Band 2</p> <p>Band 3</p> <p>Band 4</p> <p>Band 5</p> <p>Band 6</p>	<p>£582</p> <p>£597</p> <p>£610</p> <p>£621</p> <p>£658</p> <p>£688</p> <p>£727</p>



Soft seating

RECEPTION CHAIRS

ARMCHAIRS & SOFAS

MODULAR SOFAS



BOOTHS

POUFS

PRODUCT NAME	DESCRIPTION	DIMENSIONS/OPTIONS	FINISH	RRP
Tumble				
T10 	Black steel frame	W: 600mm D: 580mm Seat (H): 440mm Seat (W): 490mm Seat (D): 490mm Back (H): 340mm	Band 0	£478
			Band 1	£510
			Band 2	£541
			Band 3	£580
			Band 4	£618
			Band 5	£766
			Band 6	£875
			Options	Non standard frame colour (MOQ 5 units)
T20 	Polished beech legs	W: 600mm D: 580mm Seat (H): 440mm Seat (W): 490mm Seat (D): 490mm Back (H): 340mm	Band 0	£518
			Band 1	£550
			Band 2	£581
			Band 3	£620
			Band 4	£658
Options	Black painted legs		FOC	
	Polished oak legs		FOC	
T30 	Chrome swivel base, Gas height adjustment	W: 600mm D: 580mm Seat (H): 495-535mm Seat (W): 490mm Seat (D): 490mm Back (H): 340mm	Band 0	£545
			Band 1	£577
			Band 2	£608
			Band 3	£647
			Band 4	£685
			Band 5	£833
			Band 6	£942
Options	5-star aluminium base with castors		+£34	



RECEPTION CHAIRS

PRODUCT NAME	DESCRIPTION	DIMENSIONS/OPTIONS	FINISH	RRP
Wayvee				
WV10 	Skid frame, Bright chrome epoxy	W: 730mm D: 650mm Seat (H): 480mm Seat (W): 380mm Seat (D): 480mm Back (H): 410mm	Band 0	£524
			Band 1	£572
			Band 2	£621
			Band 3	£682
			Band 4	£742
			Band 5	£973
			Band 6	£1,143
WV30 	4-leg frame, Bright chrome epoxy	W: 730mm D: 650mm Seat (H): 480mm Seat (W): 380mm Seat (D): 480mm Back (H): 410mm	Band 0	£524
			Band 1	£572
			Band 2	£621
			Band 3	£682
			Band 4	£742
			Band 5	£973
			Band 6	£1,143
Options	Options	Non standard frame colour		FOC
		Chrome plate frame (MOQ 5 units)		+£60
WV20 	4-star swivel spider base with glides, Chrome plated	W: 730mm D: 650mm Seat (H): 480mm Seat (W): 380mm Seat (D): 480mm Back (H): 410mm	Band 0	£669
			Band 1	£717
			Band 2	£766
			Band 3	£827
			Band 4	£887
			Band 5	£1,118
			Band 6	£1,288
WV60 	Polished beech frame	W: 730mm D: 650mm Seat (H): 430mm Seat (W): 380mm Seat (D): 480mm Back (H): 410mm	Band 0	£706
			Band 1	£754
			Band 2	£803
			Band 3	£864
			Band 4	£924
			Band 5	£1,155
			Band 6	£1,325
Options	Options	Black painted frame		FOC







RECEPTION CHAIRS



PRODUCT NAME	DESCRIPTION	DIMENSIONS/OPTIONS	FINISH	RRP
Core				
C020 	4-star non swivel spider base with glides, Bright chrome epoxy	W: 570mm D: 560mm Seat (H): 430mm Seat (W): 440mm Seat (D): 470mm Back (H): 350mm	Band 0	£581
			Band 1	£616
			Band 2	£651
			Band 3	£695
			Band 4	£738
			Band 5	£905
			Band 6	£1,027
C030 	4-leg frame, Bright chrome epoxy	W: 570mm D: 560mm Seat (H): 470mm Seat (W): 440mm Seat (D): 470mm Back (H): 350mm	Band 0	£520
			Band 1	£555
			Band 2	£590
			Band 3	£634
			Band 4	£677
			Band 5	£844
			Band 6	£966
C040 	Skid frame, Bright chrome epoxy	W: 570mm D: 560mm Seat (H): 470mm Seat (W): 440mm Seat (D): 470mm Back (H): 350mm	Band 0	£520
			Band 1	£555
			Band 2	£590
			Band 3	£634
			Band 4	£677
			Band 5	£844
			Band 6	£966
Options		Non standard frame colour	FOC	
		Chrome plate base/frame (MOQ 5 units)	+£60	
C050 	4-star swivel spider base with glides, Chrome plated	W: 570mm D: 560mm Seat (H): 470mm Seat (W): 440mm Seat (D): 470mm Back (H): 350mm	Band 0	£666
			Band 1	£701
			Band 2	£736
			Band 3	£780
			Band 4	£823
			Band 5	£990
			Band 6	£1,112
C060 	Polished beech frame	W: 570mm D: 560mm Seat (H): 430mm Seat (W): 440mm Seat (D): 470mm Back (H): 350mm	Band 0	£702
			Band 1	£737
			Band 2	£772
			Band 3	£816
			Band 4	£859
			Band 5	£1,026
			Band 6	£1,148
Options		Black painted frame	FOC	



RECEPTION CHAIRS

PRODUCT NAME	DESCRIPTION	DIMENSIONS/OPTIONS	FINISH	RRP
Ego				
EG20 	4-star non swivel spider base with glides, Bright chrome epoxy	W: 640mm D: 610mm Seat (H): 460mm Seat (W): 540mm Seat (D): 500mm Back (H): 290mm	Band 0	£547
			Band 1	£578
			Band 2	£609
			Band 3	£648
			Band 4	£687
			Band 5	£835
			Band 6	£943
EG40 	Skid frame, Bright chrome epoxy	W: 640mm D: 610mm Seat (H): 460mm Seat (W): 540mm Seat (D): 500mm Back (H): 290mm	Band 0	£486
			Band 1	£517
			Band 2	£548
			Band 3	£587
			Band 4	£626
			Band 5	£774
			Band 6	£882
	Options	Non standard frame colour		FOC
		Chrome plate base/frame (MOQ 5 units)		+£60
EG50 	4-star swivel spider base with glides, Chrome plated	W: 640mm D: 610mm Seat (H): 490mm Seat (W): 540mm Seat (D): 500mm Back (H): 290mm	Band 0	£632
			Band 1	£663
			Band 2	£694
			Band 3	£733
			Band 4	£772
			Band 5	£920
			Band 6	£1,028
EG60 	Polished beech legs	W: 640mm D: 610mm Seat (H): 490mm Seat (W): 540mm Seat (D): 500mm Back (H): 290mm	Band 0	£577
			Band 1	£608
			Band 2	£639
			Band 3	£678
			Band 4	£717
			Band 5	£865
			Band 6	£973
	Options	Black painted legs		FOC
		Polished oak legs		FOC







PRODUCT NAME	DESCRIPTION	DIMENSIONS/OPTIONS	FINISH	RRP
Reception				
REC2 	Armchair, Polished beech legs	W: 720mm D: 680mm Seat (H): 430mm Seat (W): 470mm Seat (D): 510mm Back (H): 380mm	Band 0	£574
			Band 1	£633
			Band 2	£691
			Band 3	£764
			Band 4	£837
			Band 5	£1,114
			Band 6	£1,318
REC4 	2-seater sofa, Polished beech legs	W: 1240mm D: 680mm Seat (H): 430mm Seat (W): 980mm Seat (D): 510mm Back (H): 380mm	Band 0	£860
			Band 1	£944
			Band 2	£1,027
			Band 3	£1,132
			Band 4	£1,236
			Band 5	£1,633
			Band 6	£1,926
	Options	Power Module - Ellio 90mm dia, panel mounted power module - UK 13 amp plus triple USB fast charging*		+£148

Fino

FN11 	Armchair, Black finish to steel under-frame	W: 790mm D: 700mm Seat (H): 450mm Seat (W): 590mm Seat (D): 510mm Back (H): 395mm	Band 0	£797
			Band 1	£875
			Band 2	£953
			Band 3	£1,050
			Band 4	£1,147
			Band 5	£1,516
			Band 6	£1,789
FN12 	2-seater sofa, Black finish to steel under-frame	W: 1370mm D: 700mm Seat (H): 450mm Seat (W): 1170mm Seat (D): 510mm Back (H): 395mm	Band 0	£1,172
			Band 1	£1,269
			Band 2	£1,366
			Band 3	£1,488
			Band 4	£1,609
			Band 5	£2,071
			Band 6	£2,411
	Options	Non standard under-frame colour		+£26
		Power Module - Qubit USB, 100W fast charging**		+£238

*Fitted in the under seat, front panel, left-hand side as seated, unless otherwise requested.

** Fitted underneath the lower front edge, left-hand side as seated, unless otherwise requested.

PRODUCT NAME	DESCRIPTION	DIMENSIONS/OPTIONS	FINISH	RRP
Graphic				
GP1 	Armchair, Non removable individually cushioned seats, Chrome plated feet	W: 1020mm D: 780mm Seat (H): 440mm Seat (W): 650mm Seat (D): 530mm Back (H): 440mm	Band 0	£959
			Band 1	£1,051
			Band 2	£1,142
			Band 3	£1,256
			Band 4	£1,370
			Band 5	£1,804
			Band 6	£2,124
GP2 	2-seater sofa, Non removable individually cushioned seats, Chrome plated feet	W: 1660mm D: 780mm Seat (H): 440mm Seat (W): 1300mm Seat (D): 530mm Back (H): 440mm	Band 0	£1,231
			Band 1	£1,350
			Band 2	£1,469
			Band 3	£1,617
			Band 4	£1,765
			Band 5	£2,329
			Band 6	£2,744
GP3 	3-seater sofa, Non removable individually cushioned seats, Chrome plated feet	W: 2140mm D: 780mm Seat (H): 440mm Seat (W): 1800mm Seat (D): 530mm Back (H): 440mm	Band 0	£1,661
			Band 1	£1,803
			Band 2	£1,945
			Band 3	£2,123
			Band 4	£2,300
			Band 5	£2,974
			Band 6	£3,471
Options	Options	Non standard colour feet		+£26
		Polished beech feet		+£80
		Power Module - Ellio 90mm dia, panel mounted power module - UK 13 amp plus triple USB fast charging*		+£148
GP6 	Coffee table, White top, Chrome plated feet	H: 400mm Top size: 700x700mm	Band 0	£398
			Band 1	£431
			Band 2	£464
			Band 3	£505
			Band 4	£547
			Band 5	£704
			Band 6	£819
Options	Options	Non standard colour feet		+£26
		Black table top		+£30
		Beech table top		+£40
		Polished beech feet		+£80
		Power Module - Ellio 90mm dia, panel mounted power module - UK 13 amp plus triple USB fast charging**		+£148
GP7 	Scatter cushion	400x400mm	Band 0	£44
			Band 1	£54
			Band 2	£64
			Band 3	£76
			Band 4	£88
			Band 5	£134
			Band 6	£168



*Fitted in the under seat, front panel, left-hand side as seated, unless otherwise requested.

**Fitted in the front panel, right hand side as viewed, unless otherwise requested.

MEME LINKING

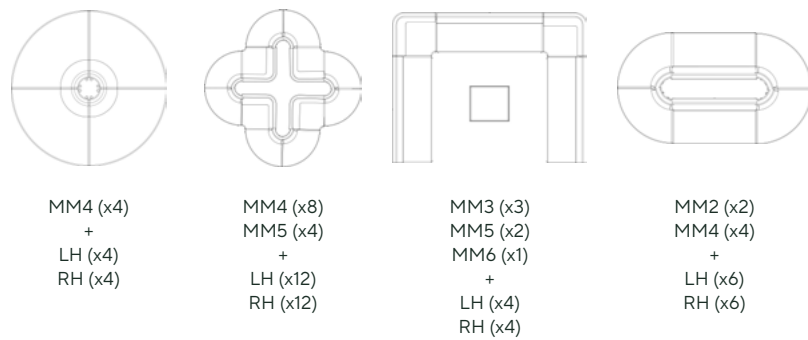
MeMe Seating units can be linked together to create an infinite variety of layout configurations. To link 2 MeMe seat units together, one will require the optional left hand (LH), as seated, linking fitted. The other will require the optional right hand (RH), as seated, linking fitted. Please can you state for each unit ordered what is required. For complex layouts, to ensure we interpret your requirements correctly, we will also ask for a plan drawing of your layout.



PRODUCT NAME	DESCRIPTION	DIMENSIONS/OPTIONS	FINISH	RRP
MeMe				
 <p>MM1</p>	Single seater sofa, Black frame	W: 600mm D: 670mm Seat (H): 440mm Seat (W): 600mm Seat (D): 500mm Back (H): 340mm	Band 0	£433
			Band 1	£459
			Band 2	£484
			Band 3	£515
			Band 4	£547
			Band 5	£667
			Band 6	£756
 <p>MM2</p>	2-seater sofa, Black frame	W: 1200mm D: 670mm Seat (H): 440mm Seat (W): 1200mm Seat (D): 500mm Back (H): 340mm	Band 0	£670
			Band 1	£719
			Band 2	£767
			Band 3	£828
			Band 4	£889
			Band 5	£1,120
			Band 6	£1,290
 <p>MM3</p>	3-seater sofa, Black frame	W: 1800mm D: 670mm Seat (H): 440mm Seat (W): 1800mm Seat (D): 500mm Back (H): 340mm	Band 0	£838
			Band 1	£902
			Band 2	£966
			Band 3	£1,046
			Band 4	£1,127
			Band 5	£1,431
			Band 6	£1,656

For options please refer to page 52.



PRODUCT NAME	DESCRIPTION	DIMENSIONS/OPTIONS	FINISH	RRP
MeMe				
MM11 	Single seater bench, Black frame	W: 600mm D: 670mm Seat (H): 440mm Seat (W): 600mm Seat (D): 670mm	Band 0	£364
			Band 1	£383
			Band 2	£403
			Band 3	£427
			Band 4	£451
			Band 5	£544
			Band 6	£612
MM12 	2-seater bench, Black frame	W: 1200mm D: 670mm Seat (H): 440mm Seat (W): 1200mm Seat (D): 670mm	Band 0	£545
			Band 1	£580
			Band 2	£615
			Band 3	£658
			Band 4	£702
			Band 5	£868
			Band 6	£991
MM13 	3-seater bench, Black frame	W: 1800mm D: 670mm Seat (H): 440mm Seat (W): 1800mm Seat (D): 670mm	Band 0	£736
			Band 1	£781
			Band 2	£826
			Band 3	£882
			Band 4	£938
			Band 5	£1,150
			Band 6	£1,307
MM4 	90 deg. external radius corner seat, Black frame	W: 1090mm D: 670mm Seat (H): 440mm Seat (W): 1090mm Seat (D): 500mm Back (H): 340mm Radius to front of seat: 725mm	Band 0	£658
			Band 1	£687
			Band 2	£716
			Band 3	£753
			Band 4	£789
			Band 5	£928
			Band 6	£1,030
MM5 	90 deg. internal corner seat, Black frame	W: 770mm D: 770mm Seat (H): 440mm Seat (W): 600mm Seat (D): 600mm Back (H): 340mm	Band 0	£690
			Band 1	£733
			Band 2	£776
			Band 3	£829
			Band 4	£883
			Band 5	£1,086
			Band 6	£1,236
Options		Non standard colour frame		+£26
		LH/RH (as seated) linking		+£40
		Power Module - Qubit USB, 100W Fast Charging*		+£238
MM6 	Coffee table, White top, Black frame	H: 440mm Top size: 600x670mm	Band 0	£477
			Band 1	£491
			Band 2	£505
			Band 3	£522
			Band 4	£539
			Band 5	£603
			Band 6	£651
Options		Non standard colour frame		+£26
		Black table top		+£30
		Beech table top		+£40
		LH/RH (as seated) linking fitted to side of table unit		+£40
		Power Module - Qubit USB, 100W Fast Charging*		+£238

*Fitted underneath the lower front edge, left-hand side as seated, unless otherwise requested.



FARINGDON LINKING

Faringdon Seating units can be linked together at the ends that do not have arms, to create an infinite variety of layout configurations. To link 2 Faringdon seat or table units together, one unit will require the optional left hand (LH), as seated, linking fitted to a non-arm end of the seat. The other unit will require the optional right hand (RH), as seated, linking fitted to a non-arm end of the seat. Please can you state for each unit ordered what is required. For complex layouts, to ensure we interpret your requirements correctly, we will also ask for a plan drawing of your layout.



PRODUCT NAME	DESCRIPTION	DIMENSIONS/OPTIONS	FINISH	RRP
Faringdon				
F1LR 	Single seater	W: 770mm D: 610mm Seat (H): 400mm Seat (W): 610mm Seat (D): 470mm Back (H): 340mm	Band 0	£497
			Band 1	£592
			Band 2	£688
			Band 3	£807
			Band 4	£926
			Band 5	£1,378
			Band 6	£1,712
F1 	Intermediate seat	W: 610mm D: 610mm Seat (H): 400mm Seat (W): 610mm Seat (D): 470mm Back (H): 340mm	Band 0	£279
			Band 1	£320
			Band 2	£361
			Band 3	£412
			Band 4	£463
			Band 5	£657
			Band 6	£800
F4 	90 deg. internal corner seat	W: 610mm D: 610mm Seat (H): 400mm Seat (W): 470mm Seat (D): 470mm Back (H): 340mm	Band 0	£367
			Band 1	£423
			Band 2	£480
			Band 3	£550
			Band 4	£621
			Band 5	£889
			Band 6	£1,086

For options please refer to page 54.



PRODUCT NAME	DESCRIPTION	DIMENSIONS/OPTIONS	FINISH	RRP
Faringdon				
F1R 	Right end seat	W: 690mm D: 610mm Seat (H): 400mm Seat (W): 610mm Seat (D): 470mm Back (H): 340mm	Band 0	£388
			Band 1	£456
			Band 2	£524
			Band 3	£609
			Band 4	£694
			Band 5	£1,018
			Band 6	£1,256
F1L 	Left end seat	W: 690mm D: 610mm Seat (H): 400mm Seat (W): 610mm Seat (D): 470mm Back (H): 340mm	Band 0	£388
			Band 1	£456
			Band 2	£524
			Band 3	£609
			Band 4	£694
			Band 5	£1,018
			Band 6	£1,256
	Options	LH/RH (as seated) linking, No link for F1LR	+£40	
		Power Module - Ellio 90mm dia, panel mounted power module - UK 13 amp plus triple USB fast charging*	+£148	
F5 	Coffee table, White top	H: 390mm Top size: 610x610mm	Band 0	£269
			Band 1	£316
			Band 2	£362
			Band 3	£421
			Band 4	£479
			Band 5	£701
			Band 6	£864
	Options	Black table top	+£30	
		Beech table top	+£40	
		LH/RH (as seated) Linking fitted to side of table unit	+£40	
		Power Module - Ellio 90mm dia, panel mounted power module - UK 13 amp plus triple USB fast charging*	+£148	

*Fitted in the under seat, front panel, right hand side as viewed, unless otherwise requested.



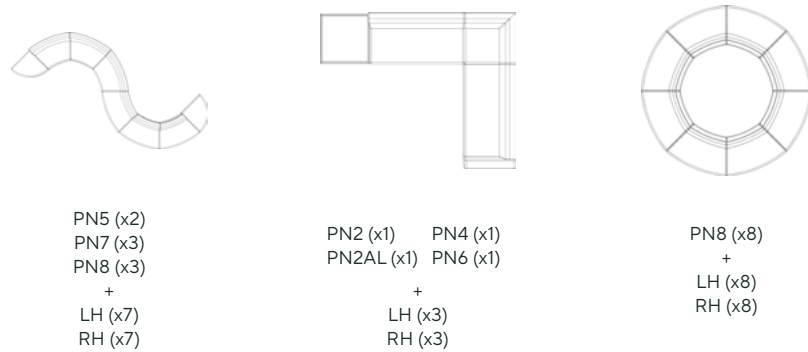



PIANO LINKING

Piano Seating units can be linked together at the ends that do not have arms, to create an infinite variety of layout configurations. To link 2 Piano seat units together, one will require the optional left hand (LH), as seated, linking fitted to a non-arm end of the seat. The other will require the optional right hand (RH), as seated, linking fitted to a non-arm end of the seat. Please can you state for each unit ordered what is required. For complex layouts, to ensure we interpret your requirements correctly, we will also ask for a plan drawing of your layout.





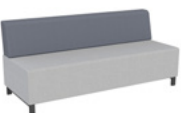



PRODUCT NAME	DESCRIPTION	DIMENSIONS/OPTIONS	FINISH	RRP
Piano				
 <p>PN1A Armchair, Black legs</p>		W: 930mm D: 715mm Seat (H): 450mm Seat (W): 670mm Seat (D): 500mm Back (H): 360mm	Band 0	£757
			Band 1	£855
			Band 2	£952
			Band 3	£1,073
			Band 4	£1,195
			Band 5	£1,657
			Band 6	£1,997
 <p>PN2A 2-seater sofa, Black legs</p>		W: 1600mm D: 715mm Seat (H): 450mm Seat (W): 1340mm Seat (D): 500mm Back (H): 360mm	Band 0	£1,019
			Band 1	£1,145
			Band 2	£1,271
			Band 3	£1,429
			Band 4	£1,587
			Band 5	£2,188
			Band 6	£2,630
 <p>PN3A 3-seater sofa, Black legs</p>		W: 2100mm D: 715mm Seat (H): 450mm Seat (W): 1840mm Seat (D): 500mm Back (H): 360mm	Band 0	£1,429
			Band 1	£1,604
			Band 2	£1,779
			Band 3	£1,997
			Band 4	£2,216
			Band 5	£3,047
			Band 6	£3,660

For options please refer to page 57.





PRODUCT NAME	DESCRIPTION	DIMENSIONS/OPTIONS	FINISH	RRP
Piano				
PN1 	Single seater, Intermediate, Black legs	W: 670mm D: 715mm Seat (H): 450mm Seat (W): 670mm Seat (D): 500mm Back (H): 360mm	Band 0	£460
			Band 1	£499
			Band 2	£537
			Band 3	£586
			Band 4	£635
			Band 5	£819
			Band 6	£956
PN1AR/PN1AL 	Single seater, Single arm right/left (as seated), Black legs	W: 800mm D: 715mm Seat (H): 450mm Seat (W): 670mm Seat (D): 500mm Back (H): 360mm	Band 0	£609
			Band 1	£677
			Band 2	£745
			Band 3	£830
			Band 4	£915
			Band 5	£1,238
			Band 6	£1,476
PN2 	2-seater, Intermediate, Black legs	W: 1340mm D: 715mm Seat (H): 450mm Seat (W): 1340mm Seat (D): 500mm Back (H): 360mm	Band 0	£721
			Band 1	£789
			Band 2	£857
			Band 3	£942
			Band 4	£1,027
			Band 5	£1,350
			Band 6	£1,589
PN2AR, PN2AL 	2-seater, Single arm right/left (as seated), Black legs	W: 1470mm D: 715mm Seat (H): 450mm Seat (W): 1340mm Seat (D): 500mm Back (H): 360mm	Band 0	£870
			Band 1	£967
			Band 2	£1,064
			Band 3	£1,186
			Band 4	£1,307
			Band 5	£1,769
			Band 6	£2,109
PN3 	3-seater, Intermediate, Black legs	W: 1840mm D: 715mm Seat (H): 450mm Seat (W): 1840mm Seat (D): 500mm Back (H): 360mm	Band 0	£1,131
			Band 1	£1,248
			Band 2	£1,364
			Band 3	£1,510
			Band 4	£1,656
			Band 5	£2,210
			Band 6	£2,619
PN3AR, PN3AL 	3-seater, Single arm right/left (as seated), Black legs	W: 1970mm D: 715mm Seat (H): 450mm Seat (W): 1840mm Seat (D): 500mm Back (H): 360mm	Band 0	£1,280
			Band 1	£1,426
			Band 2	£1,571
			Band 3	£1,754
			Band 4	£1,936
			Band 5	£2,629
			Band 6	£3,139

For options please refer to page 57.



PRODUCT NAME	DESCRIPTION	DIMENSIONS/OPTIONS	FINISH	RRP
Piano				
PN4 	90 deg. internal corner seat, Black legs	W: 715mm D: 715mm Seat (H): 450mm Seat (W): 500mm Seat (D): 500mm Back (H): 360mm	Band 0	£691
			Band 1	£746
			Band 2	£800
			Band 3	£868
			Band 4	£936
			Band 5	£1,195
			Band 6	£1,385
PN8 	45 deg. external radius corner seat, Black legs	W: 1190mm D: 715mm Seat (H): 450mm Seat (W): 1190mm Seat (D): 500mm Back (H): 360mm	Band 0	£805
			Band 1	£855
			Band 2	£906
			Band 3	£969
			Band 4	£1,032
			Band 5	£1,272
			Band 6	£1,449
PN7 	45 deg. internal radius corner seat, Black legs	W: 1190mm D: 715mm Seat (H): 450mm Seat (W): 1025mm Seat (D): 500mm Back (H): 360mm	Band 0	£837
			Band 1	£891
			Band 2	£946
			Band 3	£1,014
			Band 4	£1,082
			Band 5	£1,340
			Band 6	£1,531
PN31 	Single seater bench, Black legs	W: 670mm D: 715mm Seat (H): 450mm Seat (W): 670mm Seat (D): 715mm	Band 0	£337
			Band 1	£365
			Band 2	£392
			Band 3	£426
			Band 4	£460
			Band 5	£589
			Band 6	£684
PN32 	2-seater bench, Black legs	W: 1340mm D: 715mm Seat (H): 450mm Seat (W): 1340mm Seat (D): 715mm	Band 0	£541
			Band 1	£582
			Band 2	£623
			Band 3	£674
			Band 4	£725
			Band 5	£919
			Band 6	£1,062
PN5 	90 deg. corner bench, Black legs	W: 715mm D: 715mm Seat (H): 450mm Seat (D): 715mm	Band 0	£435
			Band 1	£465
			Band 2	£494
			Band 3	£530
			Band 4	£567
			Band 5	£705
			Band 6	£807
PN9 	45 deg. curved corner bench, Black legs	W: 1190mm D: 715mm Seat (H): 450mm Seat (W): 1190mm Seat (D): 715mm	Band 0	£626
			Band 1	£665
			Band 2	£704
			Band 3	£753
			Band 4	£801
			Band 5	£986
			Band 6	£1,122
	Options	Non standard colour to legs		+£26
		Skid legs		+£60
		Polished beech feet		+£80
		Castors		+£269
		White writing tablet fitted to LH/RH (as seated) arm		+£293
		LH/RH (as seated) linking fitted to the non-arm end of the seat		+£40
		Power Module - Ellio 90mm dia, panel mounted power module - UK 13 amp plus triple USB fast charging*		+£148

*Fitted in the under seat, front panel, right hand side as viewed, unless otherwise requested.

PRODUCT NAME	DESCRIPTION	DIMENSIONS/OPTIONS	FINISH	RRP
Piano				
PN6 	Coffee table, White top, Black legs	H: 430mm Top size: 715x715mm	Band 0	£378
			Band 1	£411
			Band 2	£444
			Band 3	£486
			Band 4	£527
			Band 5	£684
			Band 6	£799
			Options	Non standard colour to legs
Skid legs				+£60
Castors				+£269
Black table top				+£30
Beech table top				+£40
Polished beech feet				+£80
LH/RH (as seated) linking fitted to side of table unit				+£40
Power Module - Ellio 90mm dia, panel mounted power module - UK 13 amp plus triple USB fast charging*				+£148
PN11 	2-person table, White top, Black frame	H: 810mm W: 680mm D: 715mm Table (H): 715mm Table (W): 550mm Table (D): 680mm	Band 0	£820
			Band 1	£861
			Band 2	£902
			Band 3	£953
			Band 4	£1,004
			Band 5	£1,198
			Band 6	£1,341
			PN12 	4-person table, White top, Black frame
Band 1	£944			
Band 2	£985			
Band 3	£1,036			
Band 4	£1,087			
Band 5	£1,281			
Band 6	£1,424			
PN14 	6-person table, White top, Black frame	H: 810mm W: 1780mm D: 715mm Table (H): 715mm Table (W): 1650mm Table (D): 680mm		
			Band 1	£1,193
			Band 2	£1,234
			Band 3	£1,285
			Band 4	£1,336
			Band 5	£1,530
			Band 6	£1,673
			Options	Non standard colour to frame & legs
Linking to fit LH/RH (as seated) arm end of seat unit to create one side of booth				+£40
Power Module - Nano top mounted power module - UK 13 amp plus double USB fast charging**				+£86
Non standard table finish (MOQs apply)				POA



*Fitted in the under seat, front panel, right hand side as viewed, unless otherwise requested.

**Fitted on the rear edge of top, against upholstered panel.

LIBERTE LINKING

Liberte Seating can be linked together at the ends that do not have arms, to create extended, straight runs of sofa seating. To link 2 Liberte seat units together, one unit will require the optional left hand (LH), as seated, linking fitted to a non-arm end of the seat. The other unit will require the optional right hand (RH), as seated, linking fitted to a non-arm end of the seat. Please can you state for each unit ordered what is required.





PRODUCT NAME	DESCRIPTION	DIMENSIONS/OPTIONS	FINISH	RRP
Liberte				
LB1A 	Armchair, Black skid legs	W: 1030mm D: 775mm Seat (H): 460mm Seat (W): 660mm Seat (D): 530mm Back (H): 360mm	Band 0	£878
			Band 1	£973
			Band 2	£1,068
			Band 3	£1,187
			Band 4	£1,306
			Band 5	£1,759
			Band 6	£2,092
LB1A 	2-seater sofa, Black skid legs	W: 1690mm D: 775mm Seat (H): 460mm Seat (W): 1320mm Seat (D): 530mm Back (H): 360mm	Band 0	£1,164
			Band 1	£1,279
			Band 2	£1,394
			Band 3	£1,537
			Band 4	£1,680
			Band 5	£2,225
			Band 6	£2,627
LB1A 	3-seater sofa, Black skid legs	W: 2170mm D: 775mm Seat (H): 460mm Seat (W): 1800mm Seat (D): 530mm Back (H): 360mm	Band 0	£1,594
			Band 1	£1,755
			Band 2	£1,917
			Band 3	£2,119
			Band 4	£2,320
			Band 5	£3,087
			Band 6	£3,652

For options please refer to page 61.

PRODUCT NAME	DESCRIPTION	DIMENSIONS/OPTIONS	FINISH	RRP
Liberte				
LB1 	Single seater, Intermediate, Black skid legs	W: 672mm D: 775mm Seat (H): 460mm Seat (W): 672mm Seat (D): 530mm Back (H): 360mm	Band 0	£507
			Band 1	£556
			Band 2	£604
			Band 3	£665
			Band 4	£726
			Band 5	£957
			Band 6	£1,127
LB1AR/LB1AL  	Single seater, Single arm right/left (as seated), Black skid legs	W: 851mm D: 775mm Seat (H): 460mm Seat (W): 666mm Seat (D): 530mm Back (H): 360mm	Band 0	£692
			Band 1	£764
			Band 2	£836
			Band 3	£926
			Band 4	£1,016
			Band 5	£1,358
			Band 6	£1,610
LB2 	2-seater, Intermediate, Black skid legs	W: 1332mm D: 775mm Seat (H): 460mm Seat (W): 1332mm Seat (D): 530mm Back (H): 360mm	Band 0	£794
			Band 1	£862
			Band 2	£930
			Band 3	£1,015
			Band 4	£1,100
			Band 5	£1,423
			Band 6	£1,661
LB2AR, LB2AL  	2-seater, Single arm right/left (as seated), Black skid legs	W: 1511mm D: 775mm Seat (H): 460mm Seat (W): 1326mm Seat (D): 530mm Back (H): 360mm	Band 0	£979
			Band 1	£1,070
			Band 2	£1,162
			Band 3	£1,276
			Band 4	£1,390
			Band 5	£1,824
			Band 6	£2,144

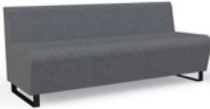
For options please refer to page 61.

PRODUCT NAME	DESCRIPTION	DIMENSIONS/OPTIONS	FINISH	RRP
Liberte				
LB3 	3-seater, Intermediate, Black skid legs	W: 1812mm D: 775mm Seat (H): 460mm Seat (W): 1812mm Seat (D): 530mm Back (H): 360mm	Band 0	£1,224
			Band 1	£1,338
			Band 2	£1,453
			Band 3	£1,596
			Band 4	£1,740
			Band 5	£2,285
			Band 6	£2,686
LB3AR, LB3AL  	3-seater, Single arm right/left (as seated), Black skid legs	W: 1991mm D: 775mm Seat (H): 460mm Seat (W): 1806mm Seat (D): 530mm Back (H): 360mm	Band 0	£1,409
			Band 1	£1,547
			Band 2	£1,685
			Band 3	£1,858
			Band 4	£2,030
			Band 5	£2,686
			Band 6	£3,169
Options	Non standard colour skid legs	+£26		
	Polished beech feet	+£80		
	Polished beech capped skid legs	+£260		
	Castors	+£269		
	LH/RH (as seated) linking fitted to non-arm end of seat unit	+£40		
	Power Module - Qubit USB, 100W Fast Charging*	+£238		



*Fitted underneath the lower front edge, left-hand side as seated, unless otherwise requested.

LILO LINKING

STRAIGHT LINKING

Lilo seating can be linked together at the ends that do not have arms, to create extended, straight runs of seating. To link 2 Lilo seat units together, one unit will require the optional left hand (LH), as seated, linking fitted to a non-arm end of the seat. The other unit will require the optional right hand (RH), as seated, linking fitted to a non-arm end of the seat. Please can you state for each unit ordered what is required.

L SHAPED, 90 DEGREE LINKING

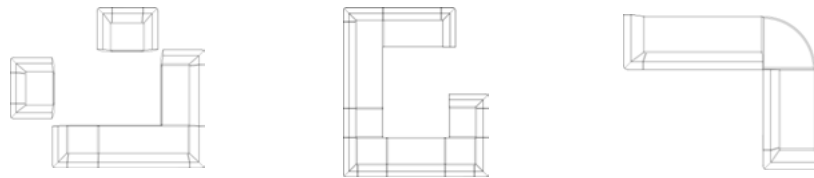

Lilo seating can also be linked together at 90 degrees to create L shaped corner sofa configurations. To link 2 Lilo seat units together in this way, one unit will require the optional LH or RH linking fitted to a non-arm end of the seat. The other unit will require the optional perpendicular linking fitted to its opposite handed arm. Please can you state for each unit ordered what is required. To ensure we interpret your requirements correctly we will also ask for a plan drawing of your layout.



LILO1A (x2) LILO1AL (x1)
 LILO2AR (x1)
 LILO3AR (x1)
 +
 LH (x2)
 RH (x1)
 RH perp. (x1)

LILO1AR (x2) LILO2 (x1)
 LILO1AL (x1) LILO2AL (x1)
 LILO1 (x1) LILO3AL (x1)
 +
 LH (x6)
 RH (x4)
 RH perp. (x2)

LILO2AR (x1)
 LILO3AL (x1)
 LILO40 (x1)
 +
 LH (x2)
 RH perp. (x2)



PRODUCT NAME	DESCRIPTION	DIMENSIONS/OPTIONS	FINISH	RRP
Lilo 	Armchair, Chrome plated legs	W: 1170mm D: 800mm Seat (H): 410mm Seat (W): 670mm Seat (D): 550mm Back (H): 365mm	Band 0	£1,228
			Band 1	£1,339
			Band 2	£1,450
			Band 3	£1,588
			Band 4	£1,727
			Band 5	£2,253
			Band 6	£2,641
	2-seater sofa, Chrome plated legs	W: 1750mm D: 800mm Seat (H): 410mm Seat (W): 1250mm Seat (D): 550mm Back (H): 365mm	Band 0	£1,517
			Band 1	£1,647
			Band 2	£1,777
			Band 3	£1,940
			Band 4	£2,103
			Band 5	£2,722
			Band 6	£3,178
	3-seater sofa, Chrome plated legs	W: 2330mm D: 800mm Seat (H): 410mm Seat (W): 1830mm Seat (D): 550mm Back (H): 365mm	Band 0	£1,878
			Band 1	£2,033
			Band 2	£2,188
			Band 3	£2,383
			Band 4	£2,577
			Band 5	£3,316
			Band 6	£3,861

For options please refer to page 64.

PRODUCT NAME	DESCRIPTION	DIMENSIONS/OPTIONS	FINISH	RRP
Lilo				
<p>LILO1</p> 	<p>Single seater, Intermediate, Chrome plated legs</p>	<p>W: 590mm D: 800mm Seat (H): 410mm Seat (W): 590mm Seat (D): 550mm Back (H): 365mm</p>	Band 0	£648
			Band 1	£697
			Band 2	£745
			Band 3	£806
			Band 4	£867
			Band 5	£1,098
			Band 6	£1,268
<p>LILO1AR, LILO1AL</p>  	<p>Single seater, Single arm right/left (as seated), Chrome plated legs</p>	<p>W: 880mm D: 800mm Seat (H): 410mm Seat (W): 630mm Seat (D): 550mm Back (H): 365mm</p>	Band 0	£938
			Band 1	£1,018
			Band 2	£1,098
			Band 3	£1,197
			Band 4	£1,297
			Band 5	£1,676
			Band 6	£1,955
<p>LILO2</p> 	<p>2-seater, Intermediate, Chrome plated legs</p>	<p>W: 1170mm D: 800mm Seat (H): 410mm Seat (W): 1170mm Seat (D): 550mm Back (H): 365mm</p>	Band 0	£937
			Band 1	£1,005
			Band 2	£1,073
			Band 3	£1,158
			Band 4	£1,243
			Band 5	£1,567
			Band 6	£1,805
<p>LILO2AR, LILO2AL</p>  	<p>2-seater, Single arm right/left (as seated), Chrome plated legs</p>	<p>W: 1460mm D: 800mm Seat (H): 410mm Seat (W): 1210mm Seat (D): 550mm Back (H): 365mm</p>	Band 0	£1,227
			Band 1	£1,326
			Band 2	£1,425
			Band 3	£1,549
			Band 4	£1,673
			Band 5	£2,144
			Band 6	£2,491



For options please refer to page 64.

PRODUCT NAME	DESCRIPTION	DIMENSIONS/OPTIONS	FINISH	RRP
Lilo				
LIL03	 <p>3-seater, Intermediate, Chrome plated legs</p>	<p>W: 1750mm D: 800mm Seat (H): 410mm Seat (W): 1750mm Seat (D): 550mm Back (H): 365mm</p>	Band 0	£1,298
			Band 1	£1,325
			Band 2	£1,418
			Band 3	£1,535
			Band 4	£1,651
			Band 5	£2,095
			Band 6	£2,421
LIL03AR, LIL03AL	  <p>3-seater, Single arm right/left (as seated), Chrome plated legs</p>	<p>W: 2040mm D: 800mm Seat (H): 410mm Seat (W): 1790mm Seat (D): 550mm Back (H): 365mm</p>	Band 0	£1,588
			Band 1	£1,712
			Band 2	£1,836
			Band 3	£1,992
			Band 4	£2,147
			Band 5	£2,739
			Band 6	£3,174
	Options	Non standard colour to legs		+£26
		Polished beech feet		+£40
		Castors		+£269
		LH/RH (as seated) linking fitted to non-arm end of seat unit		+£40
		LH/RH (as seated) perpendicular linking fitted to arm end of seat unit to create L shaped seating layout		+£40
		Power Module - Qubit USB, 100W Fast Charging*		+£238



*Fitted underneath the lower front edge, left-hand side as seated, unless otherwise requested.

DECO LINKING

STRAIGHT LINKING

Deco Seating can be linked together at the ends that do not have arms, to create extended, straight runs of seating. To link 2 Deco seat units together, one unit will require the optional left hand (LH), as seated, linking fitted to a non-arm end of the seat. The other unit will require the optional right hand (RH), as seated, linking fitted to a non-arm end of the seat. Please can you state for each unit ordered what is required.

L SHAPED, 90 DEGREE LINKING

Deco Seating can also be linked together at 90 degrees to create L shaped corner Sofa configurations. To link 2 Deco seat units together in this way, one unit will require the optional LH or RH linking fitted to a non-arm end of the seat. The other unit will require the optional perpendicular linking fitted to its opposite handed arm. Please can you state for each unit ordered what is required. For complex layouts we will also ask for a plan drawing of your layout.

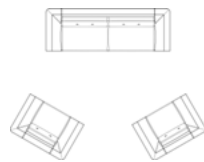

DE1A (x2)
DE3A (x1)

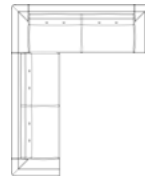

DE3A (x1)
DE3AR (x1)

+
LH (x1)
RH perp. (x1)

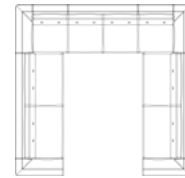

DE1AL (x1) DE3AL (x1)
DE1AR (x1) DE3AR (x1)
DE2 (x1)

+
LH (x4)
RH perp. (x4)

PRODUCT NAME	DESCRIPTION	DIMENSIONS/OPTIONS	FINISH	RRP
--------------	-------------	--------------------	--------	-----

Deco

<p>DE1A</p>	<p>Armchair, Chrome plated legs</p>	<p>W: 1170mm D: 800mm Seat (H): 480mm Seat (W): 590mm Seat (D): 535mm Back (H): 365mm</p>	Band 0	£1,491
			Band 1	£1,611
			Band 2	£1,732
			Band 3	£1,882
			Band 4	£2,033
			Band 5	£2,606
			Band 6	£3,028
<p>DE2A</p>	<p>2-seater sofa, Chrome plated legs</p>	<p>W: 1750mm D: 800mm Seat (H): 480mm Seat (W): 1170mm Seat (D): 535mm Back (H): 365mm</p>	Band 0	£2,062
			Band 1	£2,211
			Band 2	£2,361
			Band 3	£2,548
			Band 4	£2,735
			Band 5	£3,446
			Band 6	£3,970
<p>DE3A</p>	<p>3-seater sofa, Chrome plated legs</p>	<p>W: 2330mm D: 800mm Seat (H): 480mm Seat (W): 1750mm Seat (D): 535mm Back (H): 365mm</p>	Band 0	£2,525
			Band 1	£2,700
			Band 2	£2,874
			Band 3	£3,093
			Band 4	£3,312
			Band 5	£4,143
			Band 6	£4,756

For options please refer to page 67.

PRODUCT NAME	DESCRIPTION	DIMENSIONS/OPTIONS	FINISH	RRP
Deco				
DE1 	Single seater, Intermediate, Chrome plated legs	W: 590mm D: 800mm Seat (H): 480mm Seat (W): 590mm Seat (D): 535mm Back (H): 365mm	Band 0	£911
			Band 1	£969
			Band 2	£1,027
			Band 3	£1,100
			Band 4	£1,173
			Band 5	£1,450
			Band 6	£1,654
DE1AR/DE1AL 	Single seater, Single arm right/left (as seated), Chrome plated legs	W: 880mm D: 800mm Seat (H): 480mm Seat (W): 590mm Seat (D): 535mm Back (H): 365mm	Band 0	£1,201
			Band 1	£1,290
			Band 2	£1,379
			Band 3	£1,491
			Band 4	£1,603
			Band 5	£2,028
			Band 6	£2,341
DE2 	2-seater, Intermediate, Chrome plated legs	W: 1170mm D: 800mm Seat (H): 480mm Seat (W): 1170mm Seat (D): 535mm Back (H): 365mm	Band 0	£1,482
			Band 1	£1,569
			Band 2	£1,657
			Band 3	£1,766
			Band 4	£1,875
			Band 5	£2,291
			Band 6	£2,597
DE2AR, DE2AL 	2-seater, Single arm right/left (as seated), Chrome plated legs	W: 1460mm D: 800mm Seat (H): 480mm Seat (W): 1170mm Seat (D): 535mm Back (H): 365mm	Band 0	£1,772
			Band 1	£1,890
			Band 2	£2,009
			Band 3	£2,157
			Band 4	£2,305
			Band 5	£2,869
			Band 6	£3,284



For options please refer to page 67.

PRODUCT NAME	DESCRIPTION	DIMENSIONS/OPTIONS	FINISH	RRP
Deco				
DE3 	3-seater, Intermediate, Chrome plated legs	W: 1750mm D: 800mm Seat (H): 480mm Seat (W): 1750mm Seat (D): 535mm Back (H): 365mm	Band 0	£1,945
			Band 1	£2,058
			Band 2	£2,170
			Band 3	£2,311
			Band 4	£2,452
			Band 5	£2,988
			Band 6	£3,383
DE3AR, DE3AL 	3-seater, Single arm right/left (as seated), Chrome plated legs	W: 2040mm D: 800mm Seat (H): 480mm Seat (W): 1750mm Seat (D): 535mm Back (H): 365mm	Band 0	£2,235
			Band 1	£2,379
			Band 2	£2,522
			Band 3	£2,702
			Band 4	£2,882
			Band 5	£3,566
			Band 6	£4,069
DEACR, DEACL 	Arm cushion and extended back cushion, left or right hand as seated. Order in addition to Deco armchair/sofa		Band 0	£240
			Band 1	£258
			Band 2	£275
			Band 3	£297
			Band 4	£319
			Band 5	£403
			Band 6	£465
DE7 	Scatter cushion	260x450mm	Band 0	£62
			Band 1	£71
			Band 2	£81
			Band 3	£93
			Band 4	£105
			Band 5	£152
			Band 6	£186
Options			Non standard colour to legs	+£26
			Polished beech feet	+£40
			Castors	+£269
			LH/RH (as seated) linking fitted to non-arm end of seat unit	+£40
			LH/RH (as seated) perpendicular linking fitted to arm end of seat unit to create L shaped seating layout	+£40
			Power Module - Qubit USB, 100W fast charging*	+£238





*Fitted underneath the lower front edge, left-hand side as seated, unless otherwise requested.

PRODUCT NAME	DESCRIPTION	DIMENSIONS/OPTIONS	FINISH	RRP
Table for Lilo and Deco booth				
LILO21G 	Media unit, 2-person table, White top, Bright chrome epoxy frame	H: 1360mm W: 700mm D: 975mm Table (H): 680mm Table (W): 550mm Table (D): 680mm	Band 0	£1,304
			Band 1	£1,386
			Band 2	£1,467
			Band 3	£1,570
			Band 4	£1,672
			Band 5	£2,060
			Band 6	£2,345
LILO22G 	Media unit, 4-person table, White top, Bright chrome epoxy frame	H: 1360mm W: 1250mm D: 975mm Table (H): 680mm Table (W): 1100mm Table (D): 680mm	Band 0	£1,387
			Band 1	£1,469
			Band 2	£1,550
			Band 3	£1,652
			Band 4	£1,754
			Band 5	£2,142
			Band 6	£2,428
LILO23G 	Media unit, 6-person table, White top, Bright chrome epoxy frame	H: 1360mm W: 1800mm D: 975mm Table (H): 680mm Table (W): 1650mm Table (D): 680mm	Band 0	£1,636
			Band 1	£1,718
			Band 2	£1,799
			Band 3	£1,901
			Band 4	£2,004
			Band 5	£2,391
			Band 6	£2,677
Options	Non standard colour to frame & legs			+£26
	Linking to fit LH/RH (as seated) arm end of seat unit to create one side of booth. Price includes linking fitted to the arm of Lilo or Deco sofa			+£80
	Power module- Elio 90mm dia, panel mounted - UK 13 amp plus triple USB fast charging*			+£148
	Power Module - Nano top mounted power module - UK 13 amp plus double USB fast charging*			+£86
	Non standard table finish (MOQs apply)			POA



*Fitted on the rear edge of top, against upholstered panel.

PRODUCT NAME	DESCRIPTION	DIMENSIONS/OPTIONS	FINISH	RRP
Table for Lilo and Deco booth				
LILO11P 	2-person table, White top, Bright chrome epoxy frame	H: 775mm W: 700mm D: 780mm Table (H): 680mm Table (W): 550mm Table (D): 680mm	Band 0	£828
			Band 1	£869
			Band 2	£910
			Band 3	£961
			Band 4	£1,012
			Band 5	£1,206
			Band 6	£1,349
LILO12P 	4-person table, White top, Bright chrome epoxy frame	H: 775mm W: 1250mm D: 780mm Table (H): 680mm Table (W): 1100mm Table (D): 680mm	Band 0	£911
			Band 1	£951
			Band 2	£992
			Band 3	£1,043
			Band 4	£1,094
			Band 5	£1,288
			Band 6	£1,431
LILO13P 	6-person table, White top, Bright chrome epoxy frame	H: 775mm W: 1800mm D: 780mm Table (H): 680mm Table (W): 1650mm Table (D): 680mm	Band 0	£1,160
			Band 1	£1,201
			Band 2	£1,241
			Band 3	£1,292
			Band 4	£1,344
			Band 5	£1,538
			Band 6	£1,680
Options	Non standard colour to frame & legs			+£26
	Linking to fit LH/RH (as seated) arm end of seat unit to create one side of booth. Price includes linking fitted to the arm of Lilo or Deco sofa			+£80
	Power Module - Nano top mounted power module - UK 13 amp plus double USB fast charging*			+£86
	Non standard table finish (MOQs apply)			POA

*Fitted on the rear edge of top, against upholstered panel.

GRAND PIANO LINKING

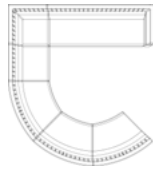

Grand Piano Seating units can be linked together at the ends that do not have arms, to create an infinite variety of layout configurations. To link 2 Grand Piano seat units together, one will require the optional left hand (LH), as seated, linking fitted to a non-arm end of the seat. The other will require the optional right hand (RH), as seated, linking fitted to a non-arm end of the seat. Please can you state for each unit ordered what is required. For complex layouts, to ensure we interpret your requirements correctly, we will also ask for a plan drawing.



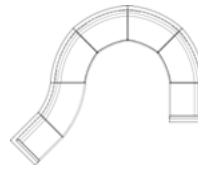



GRPN1 (x1) GRPN4 (x1)
GRPN3AL (x1) GRPN7 (x3)
+
LH (x5)
RH (x5)







GRPN1AL (x1) GRPN7 (x4)
GRPN1AR (x1) GRPN8 (x1)
+
LH (x6)
RH (x6)

PRODUCT NAME	DESCRIPTION	DIMENSIONS/OPTIONS	FINISH	RRP
Grand Piano				
GRPN1 	Single seater no arms, Rear privacy panel, Black legs	W: 670mm D: 715mm Seat (H): 450mm Seat (W): 670mm Seat (D): 500mm Back (H): 850mm	Band 0	£799
			Band 1	£865
			Band 2	£931
			Band 3	£1,014
			Band 4	£1,097
			Band 5	£1,411
			Band 6	£1,642
GRPN2 	2-seater no arms, Rear privacy panel, Black legs	W: 1340mm D: 715mm Seat (H): 450mm Seat (W): 1340mm Seat (D): 500mm Back (H): 850mm	Band 0	£1,243
			Band 1	£1,338
			Band 2	£1,433
			Band 3	£1,552
			Band 4	£1,671
			Band 5	£2,124
			Band 6	£2,457
GRPN3 	3-seater no arms, Rear privacy panel, Black legs	W: 1840mm D: 715mm Seat (H): 450mm Seat (W): 1840mm Seat (D): 500mm Back (H): 850mm	Band 0	£2,043
			Band 1	£2,198
			Band 2	£2,354
			Band 3	£2,548
			Band 4	£2,743
			Band 5	£3,482
			Band 6	£4,026

For options please refer to page 72.



PRODUCT NAME	DESCRIPTION	DIMENSIONS/OPTIONS	FINISH	RRP
Grand Piano				
GRPN1A 	Single seater with both arms, Full privacy panel, Black legs	W: 930mm D: 715mm Seat (H): 450mm Seat (W): 670mm Seat (D): 500mm Back (H): 850mm	Band 0	£1,509
			Band 1	£1,684
			Band 2	£1,859
			Band 3	£2,078
			Band 4	£2,297
			Band 5	£3,128
			Band 6	£3,740
GRPN2A 	2-seater with both arms, Full privacy panel, Black legs	W: 1600mm D: 715mm Seat (H): 450mm Seat (W): 1340mm Seat (D): 500mm Back (H): 850mm	Band 0	£1,953
			Band 1	£2,157
			Band 2	£2,361
			Band 3	£2,616
			Band 4	£2,871
			Band 5	£3,841
			Band 6	£4,555
GRPN3A 	3-seater with both arms, Full privacy panel, Black legs	W: 2100mm D: 715mm Seat (H): 450mm Seat (W): 1840mm Seat (D): 500mm Back (H): 850mm	Band 0	£2,753
			Band 1	£3,017
			Band 2	£3,281
			Band 3	£3,612
			Band 4	£3,943
			Band 5	£5,199
			Band 6	£6,124
GRPN1AR/GRPN1AL 	Single seater with one arm, Left/right as seated, One side full privacy panel, Black legs	W: 800mm D: 715mm Seat (H): 450mm Seat (W): 670mm Seat (D): 500mm Back (H): 850mm	Band 0	£1,154
			Band 1	£1,277
			Band 2	£1,399
			Band 3	£1,552
			Band 4	£1,705
			Band 5	£2,287
			Band 6	£2,716
GRPN2AR/GRPN2AL 	2-seater with one arm, Left/right as seated, One side full privacy panel, Black legs	W: 1470mm D: 715mm Seat (H): 450mm Seat (W): 1340mm Seat (D): 500mm Back (H): 850mm	Band 0	£1,598
			Band 1	£1,749
			Band 2	£1,901
			Band 3	£2,090
			Band 4	£2,280
			Band 5	£3,000
			Band 6	£3,531

For options please refer to page 72.

PRODUCT NAME	DESCRIPTION	DIMENSIONS/OPTIONS	FINISH	RRP
Grand Piano				
<p>GRPN3AR/GRPN3AL</p> 	<p>3-seater with one arm, Left/right as seated, One side full privacy panel, Black legs</p>	<p>W: 1970mm D: 715mm Seat (H): 450mm Seat (W): 1840mm Seat (D): 500mm Back (H): 850mm</p>	Band 0	£2,398
			Band 1	£2,610
			Band 2	£2,822
			Band 3	£3,087
			Band 4	£3,352
			Band 5	£4,358
			Band 6	£5,100
<p>GRPN4</p> 	<p>90 deg. internal corner seat Rear privacy panel, Black legs</p>	<p>W: 750mm D: 715mm Seat (H): 450mm Seat (W): 500mm Seat (D): 500mm Back (H): 850mm</p>	Band 0	£1,212
			Band 1	£1,299
			Band 2	£1,387
			Band 3	£1,496
			Band 4	£1,605
			Band 5	£2,021
			Band 6	£2,327
<p>GRPN7</p> 	<p>45 deg. internal radius corner seat Rear privacy panel, Black legs</p>	<p>W: 1190mm D: 715mm Seat (H): 450mm Seat (W): 1040mm Seat (D): 500mm Back (H): 850mm</p>	Band 0	£1,484
			Band 1	£1,568
			Band 2	£1,651
			Band 3	£1,756
			Band 4	£1,860
			Band 5	£2,257
			Band 6	£2,550
<p>GRPN8</p> 	<p>45 deg. external radius corner seat Rear privacy panel, Black legs</p>	<p>W: 1190mm D: 715mm Seat (H): 450mm Seat (W): 1190mm Seat (D): 500mm Back (H): 850mm</p>	Band 0	£1,379
			Band 1	£1,459
			Band 2	£1,539
			Band 3	£1,638
			Band 4	£1,738
			Band 5	£2,117
			Band 6	£2,396
Options	Non standard colour to legs			+£26
	Skid legs			+£60
	Polished beech feet			+£80
	Castors			+£269
	White writing tablet fitted to LH/RH (as seated) arm			+£293
	LH/RH (as seated) linking fitted to non-arm end of seat unit			+£40
	LH/RH (as seated) linking fitted to arm to link to table unit for Booth			+£40
	Power module- Elio 90mm dia, panel mounted - UK 13 amp plus triple USB fast charging*			+£148



*Fitted in the under seat, front panel, right hand side as viewed, unless otherwise requested.

PRODUCT NAME	DESCRIPTION	DIMENSIONS/OPTIONS	FINISH	RRP
Table for Grand Piano booth				
GRPN11 	Media unit, 2-person table, White top, Black frame	H: 1360mm W: 680mm D: 715mm Table (H): 715mm Table (W): 550mm Table (D): 680mm	Band 0	£908
			Band 1	£971
			Band 2	£1,034
			Band 3	£1,113
			Band 4	£1,192
			Band 5	£1,491
			Band 6	£1,711
GRPN12 	Media unit, 4-person table, White top, Black frame	H: 1360mm W: 1230mm D: 715mm Table (H): 715mm Table (W): 1100mm Table (D): 680mm	Band 0	£987
			Band 1	£1,050
			Band 2	£1,113
			Band 3	£1,192
			Band 4	£1,270
			Band 5	£1,569
			Band 6	£1,790
GRPN14 	Media unit, 6-person table, White top, Black frame	H: 1360mm W: 1780mm D: 715mm Table (H): 715mm Table (W): 1650mm Table (D): 680mm	Band 0	£1,286
			Band 1	£1,352
			Band 2	£1,418
			Band 3	£1,500
			Band 4	£1,583
			Band 5	£1,897
			Band 6	£2,128
Options		Non standard colour to frame & legs	+£26	
		Linking to fit LH/RH (as seated) arm end of seat unit to create one side of booth	+£40	
		Cable port positioned above power module	+£10	
		Power module - Elio 90mm dia, media panel mounted - UK 13 amp plus triple USB fast charging	+£148	
		Power module - Nano top mounted power module - UK 13 amp plus double USB fast charging	+£86	
		Non standard table finish	POA	





*Fitted on the rear edge of top, against upholstered panel.

LIBERTE HIGH LINKING

Liberte high seating can be linked together at the ends that do not have arms, to create extended, straight runs of sofa seating. To link 2 Liberte High seat units together, one unit will require the optional left hand (LH), as seated, linking fitted to a non-arm end of the seat. The other unit will require the optional right hand (RH), as seated, linking fitted to a non-arm end of the seat. Please can you state for each unit ordered what is required.





PRODUCT NAME	DESCRIPTION	DIMENSIONS/OPTIONS	FINISH	RRP
Liberte High				
LB10 	Single seater no arms, Rear privacy panel, Black skid base	W: 672mm D: 815mm H: 1390mm Seat (H): 460mm Seat (W): 672mm Seat (D): 530mm Back (H): 360mm	Band 0	£816
			Band 1	£903
			Band 2	£991
			Band 3	£1,100
			Band 4	£1,210
			Band 5	£1,625
			Band 6	£1,931
LB20 	2-seater no arms, Rear privacy panel, Black skid base	W: 1332mm D: 815mm H: 1390mm Seat (H): 460mm Seat (W): 1332mm Seat (D): 530mm Back (H): 360mm	Band 0	£1,356
			Band 1	£1,502
			Band 2	£1,648
			Band 3	£1,830
			Band 4	£2,012
			Band 5	£2,705
			Band 6	£3,215
LB30 	3-seater no arms, Rear privacy panel, Black skid base	W: 1812mm D: 815mm H: 1390mm Seat (H): 460mm Seat (W): 1812mm Seat (D): 530mm Back (H): 360mm	Band 0	£2,051
			Band 1	£2,243
			Band 2	£2,435
			Band 3	£2,676
			Band 4	£2,917
			Band 5	£3,831
			Band 6	£4,505

For options please refer to page 76.

PRODUCT NAME	DESCRIPTION	DIMENSIONS/OPTIONS	FINISH	RRP
Liberte High				
LB12A 	Single seater with both arms, Rear privacy panel, Black skid base	W: 1030mm D: 815mm H: 1390mm Seat (H): 460mm Seat (W): 660mm Seat (D): 530mm Back (H): 360mm	Band 0	£1,186
			Band 1	£1,320
			Band 2	£1,454
			Band 3	£1,622
			Band 4	£1,790
			Band 5	£2,427
			Band 6	£2,897
LB22A 	2-seater with both arms, Rear privacy panel, Black skid base	W: 1690mm D: 815mm H: 1390mm Seat (H): 460mm Seat (W): 1320mm Seat (D): 530mm Back (H): 360mm	Band 0	£1,726
			Band 1	£1,919
			Band 2	£2,111
			Band 3	£2,352
			Band 4	£2,592
			Band 5	£3,507
			Band 6	£4,181
LB32A 	3-seater with both arms, Rear privacy panel, Black skid base	W: 2170mm D: 815mm H: 1390mm Seat (H): 460mm Seat (W): 1800mm Seat (D): 530mm Back (H): 360mm	Band 0	£2,421
			Band 1	£2,660
			Band 2	£2,898
			Band 3	£3,198
			Band 4	£3,497
			Band 5	£4,633
			Band 6	£5,471
LB15A 	Single seater with both arms, Semi-wrap around privacy panel, Black skid base	W: 1110mm D: 815mm H: 1390mm Seat (H): 460mm Seat (W): 660mm Seat (D): 530mm Back (H): 360mm	Band 0	£1,742
			Band 1	£1,977
			Band 2	£2,212
			Band 3	£2,506
			Band 4	£2,800
			Band 5	£3,918
			Band 6	£4,742
LB25A 	2-seater with both arms, Semi-wrap around privacy panel, Black skid base	W: 1770mm D: 815mm H: 1390mm Seat (H): 460mm Seat (W): 1320mm Seat (D): 530mm Back (H): 360mm	Band 0	£2,282
			Band 1	£2,576
			Band 2	£2,869
			Band 3	£3,236
			Band 4	£3,602
			Band 5	£4,998
			Band 6	£6,026
LB35A 	3-seater with both arms, Semi-wrap around privacy panel, Black skid base	W: 2250mm D: 815mm H: 1390mm Seat (H): 460mm Seat (W): 1800mm Seat (D): 530mm Back (H): 360mm	Band 0	£2,977
			Band 1	£3,317
			Band 2	£3,656
			Band 3	£4,082
			Band 4	£4,507
			Band 5	£6,124
			Band 6	£7,316





PRODUCT NAME	DESCRIPTION	DIMENSIONS/OPTIONS	FINISH	RRP
Liberte High				
LB15AR/LB15AL	 <p>Single seater with one arm, Left/right as seated, Semi-wrap around privacy panel, Black skid base</p>	W: 891mm D: 815mm H: 1390mm Seat (H): 460mm Seat (W): 660mm Seat (D): 530mm Back (H): 360mm	Band 0	£1,279
			Band 1	£1,440
			Band 2	£1,601
			Band 3	£1,803
			Band 4	£2,005
			Band 5	£2,772
			Band 6	£3,336
LB25AR/LB25AL	 <p>2-seater with one arm, Left/right as seated, Semi-wrap around privacy panel, Black skid base</p>	W: 1551mm D: 815mm H: 1390mm Seat (H): 460mm Seat (W): 1320mm Seat (D): 530mm Back (H): 360mm	Band 0	£1,819
			Band 1	£2,039
			Band 2	£2,258
			Band 3	£2,533
			Band 4	£2,808
			Band 5	£3,851
			Band 6	£4,620
LB35AR/LB35AL	 <p>3-seater with one arm, Left/right as seated, Semi-wrap around privacy panel, Black skid base</p>	W: 2031mm D: 815mm H: 1390mm Seat (H): 460mm Seat (W): 1806mm Seat (D): 530mm Back (H): 360mm	Band 0	£2,514
			Band 1	£2,780
			Band 2	£3,046
			Band 3	£3,379
			Band 4	£3,712
			Band 5	£4,978
			Band 6	£5,910
	Options	Non standard colour to legs		+£26
		Polished beech feet		+£80
		Polished beech capped skid legs		+£260
		Castors		+£269
		LH/RH (as seated) linking fitted to non-arm end of seat unit		+£40
		Power module - Qubit USB, 100W fast charging*		+£238





*Fitted underneath the lower front edge, left-hand side as seated, unless otherwise requested.

PRODUCT NAME	DESCRIPTION	DIMENSIONS/OPTIONS	FINISH	RRP
Grand Piano booth				
GRPNB2 	2-seater media booth with table, White top, Black frame Linking included	W: 680mm D: 2140mm H: 1360mm Table (H): 715mm Table (W): 550mm Table (D): 680mm	Band 0	£4,086
			Band 1	£4,499
			Band 2	£4,912
			Band 3	£5,429
			Band 4	£5,946
			Band 5	£7,907
			Band 6	£9,351
GRPNB4 	4-seater media booth with table, White top, Black frame Linking included	W: 1230mm D: 2140mm H: 1360mm Table (H): 715mm Table (W): 1100mm Table (D): 680mm	Band 0	£5,053
			Band 1	£5,524
			Band 2	£5,995
			Band 3	£6,584
			Band 4	£7,172
			Band 5	£9,411
			Band 6	£11,060
GRPNB6 	6-seater media booth with table, White top, Black frame Linking included	W: 1780mm D: 2140mm H: 1360mm Table (H): 715mm Table (W): 1650mm Table (D): 680mm	Band 0	£6,952
			Band 1	£7,546
			Band 2	£8,140
			Band 3	£8,884
			Band 4	£9,629
			Band 5	£12,455
			Band 6	£14,536
Options	Non standard colour to frame & legs	+£26		
	Cable port positioned above power module	+£10		
	Power module - Elio 90mm dia, media panel mounted - UK 13 amp plus triple USB fast charging	+£148		
	Power module - Nano top mounted power module - UK 13 amp plus double USB fast charging*	+£86		
	Non standard table finish	POA		

*Fitted on the rear edge of top, against upholstered panel.

PRODUCT NAME	DESCRIPTION	DIMENSIONS/OPTIONS	FINISH	RRP
Piano booth				
PNB2 	2-seater booth with table, White top, Black frame Linking included	W: 680mm D: 2140mm H: 810mm Table (H): 715mm Table (W): 550mm Table (D): 680mm	Band 0	£2,494
			Band 1	£2,731
			Band 2	£2,966
			Band 3	£3,259
			Band 4	£3,554
			Band 5	£4,672
			Band 6	£5,495
PNB4 	4-seater booth with table, White top, Black frame Linking included	W: 1230mm D: 2140mm H: 810mm Table (H): 715mm Table (W): 1100mm Table (D): 680mm	Band 0	£3,101
			Band 1	£3,394
			Band 2	£3,687
			Band 3	£4,054
			Band 4	£4,421
			Band 5	£5,817
			Band 6	£6,844
PNB6 	6-seater booth with table, White top, Black frame Linking included	W: 1780mm D: 2140mm H: 810mm Table (H): 715mm Table (W): 1650mm Table (D): 680mm	Band 0	£4,170
			Band 1	£4,561
			Band 2	£4,952
			Band 3	£5,439
			Band 4	£5,928
			Band 5	£7,784
			Band 6	£9,153
Options		Non standard colour to frame & legs	+£26	
		Power module - Nano top mounted power module - UK 13 amp plus double USB fast charging*	+£86	
		Non standard table finish	POA	

*Fitted on the rear edge of top, against upholstered panel.

PRODUCT NAME	DESCRIPTION	DIMENSIONS/OPTIONS	FINISH	RRP
Skittle				
SK50 	Cylinder pouf with carpet glides	Seat (H): 480mm Seat (H) with castors: 550mm Seat dia: 480mm	Band 0	£213
			Band 1	£242
			Band 2	£271
			Band 3	£308
			Band 4	£344
			Band 5	£483
			Band 6	£584
SK51 	Cube pouf with carpet glides	Seat (H): 480mm Seat (H) with castors: 550mm Seat dia: 480mm	Band 0	£225
			Band 1	£254
			Band 2	£283
			Band 3	£320
			Band 4	£356
			Band 5	£495
			Band 6	£596
Options			Castors	+£40
			Velcro linking* <i>Price is to link 2 units together</i>	+£69
SK55 	Curved round pouf with chrome plated legs	Seat (H): 480mm Seat dia: 690mm	Band 0	£327
			Band 1	£357
			Band 2	£386
			Band 3	£422
			Band 4	£459
			Band 5	£597
			Band 6	£698
SK56 	Scalloped round pouf with chrome plated legs	Seat (H): 480mm Seat (W): 590mm Seat dia: 690mm	Band 0	£327
			Band 1	£357
			Band 2	£386
			Band 3	£422
			Band 4	£459
			Band 5	£597
			Band 6	£698
Options			Castors	+£18
			Velcro linking* <i>Price is to link 2 units together</i>	+£69

*We require a drawing to indicate the required positioning of the links on each piece.
The curved face of an SK55 or SK56 can be linked to to the scalloped face of an SK56.



A2 A.M
540

A2 cross
511

R3 front & back bar
540

R3
6

450

Tables

COFFEE

BREAKOUT

MEETING

POSEUR

Standard MFC finishes

All RRP in this Price List are for our standard MFC finishes.

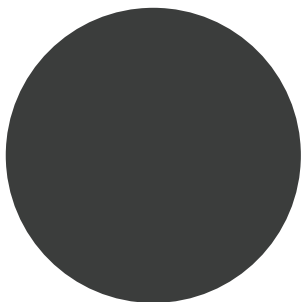

MFC/ANT Anthracite
Kronospan U164

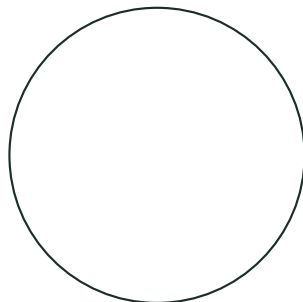

MFC/WH White
Kronospan K101

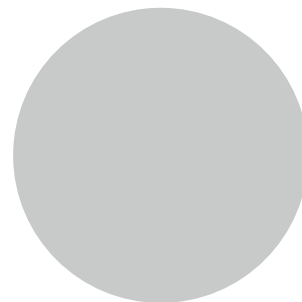

MFC/LGRY Light grey
Kronospan U112

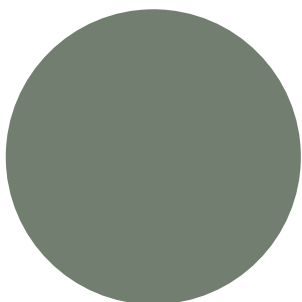

MFC/RG Reed green
Egger U604 ST9

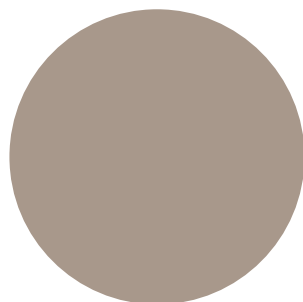

MFC/SG Stone grey
Egger U727

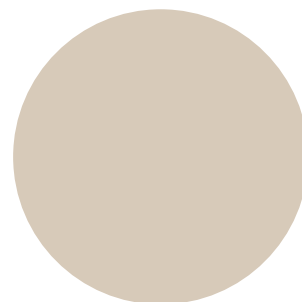

MFC/CG Cashmere grey
Egger U702 ST9



MFC/GCO Gold craft oak
Kronospan K003



MFC/NNE Natural noble elm
Kronospan D5500



MFC/KO Kaisersberg oak
Egger H3349 ST19

For MFC ply edge option please add 'PLY' after the MFC finish code – e.g. MFC/ANT/PLY.
For contrasting edge details, add the corresponding code after the MFC finish code – e.g. MFC/WH(BLK).

Tables



Coffee

PRODUCT NAME	DESCRIPTION	DIMENSIONS	PRODUCT CODE	RRP
Cyrus Coffee				
	Oversized rectangular black tubular frame, White MFC top	H: 350mm W: 550mm D: 550mm	C20	£278
		H: 350mm W: 1100mm D: 550mm	C30	£336
Options		Non standard frame colour (MOQ 5 units)		+£13
		Chrome plate frame (MOQ 5 units)		+£60
		Non standard table finish (MOQs apply)		POA

Wayvee Coffee

	Bright chrome epoxy frame, White MFC top	H: 405mm W: 680mm D: 680mm	WV40	£386
			WV50	
Options		Non standard frame colour		FOC
		Chrome plate frame (MOQ 5 units)		+£60
		Non standard table finish (MOQs apply)		POA



Pillar Coffee

			Standard pillar	Cable managed pillar*	
Round 	White, black or raw, round or square base, MFC top H: 425mm	600mm dia	ALB/MPC/600/□/RB/● ALB/MPC/600/□/SB/●	£551	£655
		700mm dia	ALB/MPC/700/□/RB/● ALB/MPC/700/□/SB/●	£552	£656
		800mm dia	ALB/MPC/800/□/RB/● ALB/MPC/800/□/SB/●	£589	£696
		900mm dia	ALB/MPC/900/□/RB/● ALB/MPC/900/□/SB/●	£593	£699
		1000mm dia	ALB/MPC/1000/□/RB/● ALB/MPC/1000/□/SB/●	£597	£704
		1100mm dia	ALB/MPC/1100/□/RB/● ALB/MPC/1100/□/SB/●	£604	£712
		1200mm dia	ALB/MPC/1200/□/RB/● ALB/MPC/1200/□/SB/●	£638	£747
Square 		600x600mm	ALB/MPC/6060/□/RB/● ALB/MPC/6060/□/SB/●	£431	£521
		700x700mm	ALB/MPC/7070/□/RB/● ALB/MPC/7070/□/SB/●	£448	£540
		800x800mm	ALB/MPC/8080/□/RB/● ALB/MPC/8080/□/SB/●	£448	£540
		900x900mm	ALB/MPC/9090/□/RB/● ALB/MPC/9090/□/SB/●	£464	£556

* Add /CMP at end of code for Cable Managed Pillar base.

Replace □ with metalwork colour: WH, BLK or RAW.

Replace ● with MFC finish. Contrasting edge on top will be FOC. Acrylic ply edge will carry a 12% upcharge to RRP.

PRODUCT NAME	DESCRIPTION	DIMENSIONS	PRODUCT CODE	RRP
Cloud Coffee				
Round 	Oak legs, White, black or raw frame, MFC top H: 455mm	600mm dia (3-leg)	ALB/HUBCT/600/□/●	£488
		650mm dia (3-leg)	ALB/HUBCT/650/□/●	£489
		700mm dia (3-leg)	ALB/HUBCT/700/□/●	£523
		800mm dia	ALB/HUBCT/800/□/●	£616
		900mm dia	ALB/HUBCT/900/□/●	£619
Square 		600x600mm	ALB/HUBCT/6060/□/●	£450
		700x700mm	ALB/HUBCT/7070/□/●	£468
		800x800mm	ALB/HUBCT/8080/□/●	£468
		900x900mm	ALB/HUBCT/9090/□/●	£484
		1000x500mm	ALB/HUBCT/1050/□/●	£472
	1000x600mm	ALB/HUBCT/1060/□/●	£481	
	1200x500mm	ALB/HUBCT/1250/□/●	£479	
	1200x600mm	ALB/HUBCT/1260/□/●	£495	

Replace □ with metalwork colour: WH, BLK or RAW.

Replace ● with MFC finish. Contrasting edge on top will be FOC. Acrylic ply edge will carry a 12% upcharge to RRP.

Black stained oak legs available with a 5% upcharge to RRP.

Tables



Breakout

PRODUCT NAME	DESCRIPTION	DIMENSIONS/OPTIONS	PRODUCT CODE	RRP
Piano				
	Laptop table, Black frame, White MFC top	H: 625mm W: 590mm D: 460mm	PN15	£293
Options		Non standard frame colour		+£13
		Chrome plate frame (MOQ 5 units)		+£60
		Non standard table finish (MOQs apply)		POA

Podium

	Black base, MFC top, H: 765mm	700mm dia	MAD/G8T/700/BLK/●	£430
		700x700mm	MAD/G8T/7070/BLK/●	£299
		800mm dia	MAD/G8T/800/BLK/●	£436
		800x800mm	MAD/G8T/8080/BLK/●	£299

Pillar



				Standard pillar	Cable managed pillar*
Round 	White, black or raw, round or square base, MFC top, H: 720mm	600mm dia	ALB/MPD/600/□/RB/● ALB/MPD/600/□/SB/●	£605	£679
		700mm dia	ALB/MPD/700/□/RB/● ALB/MPD/700/□/SB/●	£605	£679
		800mm dia	ALB/MPD/800/□/RB/● ALB/MPD/800/□/SB/●	£644	£719
		900mm dia	ALB/MPD/900/□/RB/● ALB/MPD/900/□/SB/●	£648	£722
		1000mm dia	ALB/MPD/1000/□/RB/● ALB/MPD/1000/□/SB/●	£652	£726
		1100mm dia	ALB/MPD/1100/□/RB/● ALB/MPD/1100/□/SB/●	£661	£735
		1200mm dia	ALB/MPD/1200/□/RB/● ALB/MPD/1200/□/SB/●	£696	£770
Square 		600x600mm	ALB/MPD/6060/□/RB/● ALB/MPD/6060/□/SB/●	£478	£553
		700x700mm	ALB/MPD/7070/□/RB/● ALB/MPD/7070/□/SB/●	£496	£571
		800x800mm	ALB/MPD/8080/□/RB/● ALB/MPD/8080/□/SB/●	£496	£571
		900x900mm	ALB/MPD/9090/□/RB/● ALB/MPD/9090/□/SB/●	£513	£588

* Add /CMP at end of code for Cable Managed Pillar base.

Replace □ with metalwork colour: WH, BLK or RAW.

Replace ● with MFC finish. Contrasting edge on top will be FOC. Acrylic ply edge will carry a 12% upcharge to RRP.



PRODUCT NAME	DESCRIPTION	DIMENSIONS	PRODUCT CODE	RRP	
Box				700mm deep	800mm deep
	White, black or raw frame, Single MFC top, H: 740mm	1000mm	ALB/MD/1070/□/● ALB/MD/1080/□/●	£591	£614
		1200mm	ALB/MD/1270/□/● ALB/MD/1280/□/●	£611	£634
		1400mm	ALB/MD/1470/□/● ALB/MD/1480/□/●	£636	£659
		1500mm	ALB/MD/1570/□/● ALB/MD/1580/□/●	£636	£659
		1600mm	ALB/MD/1670/□/● ALB/MD/1680/□/●	£637	£660
		1800mm	ALB/MD/1870/□/● ALB/MD/1880/□/●	£707	£732
		2000mm	ALB/MD/2070/□/● ALB/MD/2080/□/●	£763	£786
		2200mm	ALB/MD/2270/□/● ALB/MD/2280/□/●	£763	£787
	White, black or raw frame, Multi MFC top, H: 740mm	2400mm	ALB/MD/2470/□/● ALB/MD/2480/□/●	£1,291	£1,320
		2800mm	ALB/MD/2870/□/● ALB/MD/2880/□/●	£1,342	£1,370
		3000mm	ALB/MD/3070/□/● ALB/MD/3080/□/●	£1,343	£1,371
		3200mm	ALB/MD/3270/□/● ALB/MD/3280/□/●	£1,343	£1,373
		3600mm	ALB/MD/3670/□/● ALB/MD/3680/□/●	£1,400	£1,517
		4000mm	ALB/MD/4070/□/● ALB/MD/4080/□/●	£1,510	£1,625
		4400mm	ALB/MD/4470/□/● ALB/MD/4480/□/●	£1,511	£1,626
		4500mm (3-piece)	ALB/MD/4570/□/● ALB/MD/4580/□/●	£1,919	£1,955
4800mm (3-piece)	ALB/MD/4870/□/● ALB/MD/4880/□/●	£1,921	£1,957		
				350mm deep	
Bench 	White, black or raw frame, MFC top, H: 410mm	1000mm	ALB/MB/1035/□/●	£458	
		1200mm	ALB/MB/1235/□/●	£481	
		1400mm	ALB/MB/1435/□/●	£501	
		1500mm	ALB/MB/1535/□/●	£501	
		1600mm	ALB/MB/1635/□/●	£501	
		1800mm	ALB/MB/1835/□/●	£557	
		2000mm	ALB/MB/2035/□/●	£611	
		2200mm	ALB/MB/2235/□/●	£612	

Replace □ with metalwork colour: WH, BLK or RAW.

Replace ● with MFC finish.

Single top table - Contrasting edge on top will be FOC. Acrylic ply edge will carry a 12% upcharge to RRP.

Multi top table - Contrasting & Acrylic ply edge will carry a 25% upcharge to RRP.

Tables

Meeting

Cloud

Single top
H: 740mm



Multi top
H: 740mm



WIDTH	RRP / TOP DEPTH							
	800mm	900mm	1000mm	1200mm	1400mm	1500mm	1600mm	
1200mm	£943	£947	£951	£1,033	-	-	-	
1400mm	£963	£966	£970	£1,066	£1,075	-	-	
1500mm	£968	£971	£975	£1,071	£1,081	£1,086	-	
1600mm	£968	£971	£976	£1,072	£1,082	£1,086	£1,088	
1800mm	£1,023	£1,027	£1,030	£1,136	£1,145	£1,150	£1,150	
2000mm	£1,036	£1,040	£1,043	£1,149	£1,158	£1,163	£1,163	
2200mm	£1,040	£1,043	£1,047	£1,153	£1,162	£1,168	£1,168	
2400mm	£1,065	£1,069	£1,072	£1,200	£1,210	£1,215	£1,216	
2400mm	£1,740	£1,745	£1,751	£1,904	£1,960	£1,966	£1,967	
2600mm	£1,771	£1,775	£1,780	£1,961	£1,971	£1,977	£1,979	
2800mm	£1,787	£1,791	£1,795	£1,978	£1,988	£1,993	£1,994	
3000mm	£1,790	£1,793	£1,798	£1,980	£1,990	£1,996	£1,998	
3200mm	£1,790	£1,793	£1,798	£1,980	£1,990	£1,996	£1,998	
3400mm	£1,904	£1,908	£1,911	£2,111	£2,120	£2,126	£2,127	
3600mm	£1,904	£1,908	£1,911	£2,111	£2,120	£2,126	£2,127	
3800mm	£1,911	£1,915	£1,920	£2,120	£2,129	£2,135	£2,136	
4000mm	£1,911	£1,915	£1,920	£2,120	£2,129	£2,135	£2,136	
4200mm	£1,915	£1,920	£1,924	£2,125	£2,134	£2,140	£2,141	
4400mm	£1,915	£1,920	£1,924	£2,125	£2,134	£2,140	£2,141	
4500mm*	£2,486	£2,490	£2,495	£2,767	£2,778	£2,784	£2,785	
4800mm*	£2,500	£2,505	£2,509	£2,781	£2,793	£2,798	£2,802	
5400mm*	£2,663	£2,667	£2,670	£2,969	£2,979	£2,985	£2,986	
6000mm*	£2,673	£2,677	£2,682	£2,980	£2,990	£2,996	£2,998	

* 3-piece top

Round
H: 740mm



800mm dia (3-leg)	£682
900mm dia (3-leg)	£685
1000mm dia (3-leg)	£687
800mm dia	£810
900mm dia	£812
1000mm dia	£815
1200mm	£888
1300mm	£889
1400mm	£1,025
1500mm	£1,025
1600mm	£1,025

Square
H: 740mm



600 x 600mm	£649
700 x 700mm	£668
800 x 800mm	£668
900 x 900mm	£716
1000 x 1000mm	£731

Natural oak legs with MFC top as standard. Black stained oak legs available with a 5% upcharge to RRP.
Metalwork available in WH, BLK or RAW.
Single top table - Contrasting edge on top will be FOC. Acrylic ply edge will carry a 12% upcharge to RRP.
Multi top table - Contrasting & Acrylic ply edge will carry a 25% upcharge to RRP.

Contact us for product code.



Wing	RRP / TOP DEPTH			
	WIDTH	600mm	700mm	800mm
H: 720mm 	1000mm	£569	£595	£612
	1200mm	£583	£598	£615
	1400mm	£588	£614	£630
	1500mm	£589	£614	£631
	1600mm	£593	£618	£635
	1800mm	£634	£668	£687
	2000mm	£638	£673	£690

Metalwork available in WH, BLK or RAW with MFC top.
 Contrasting edge on top will be FOC. Acrylic ply edge will carry a 12% upcharge to RRP.

Wing accessories

Cable tray 	1200mm	£100
	1400mm	
	1600mm	
	1800mm	
	2000mm	
Modesty panel - metal 	1400mm	£127
	1600mm	
	1800mm	
	2000mm	
Cable riser clip 	Clips onto the leg upright	£26
Castors 		£42
Linking plate 	Linking plate kit	£13

Tables



Poseur

PRODUCT NAME	DESCRIPTION	DIMENSIONS	PRODUCT CODE	RRP
--------------	-------------	------------	--------------	-----

Podium Poseur



	Black base, MFC top, H: 1055mm	700mm dia	MAD/G8BT/700/BLK/●	£563
		700x700mm	MAD/G8BT/7070/BLK/●	£397
		800mm dia	MAD/G8BT/800/BLK/●	£570
		800x800mm	MAD/G8BT/8080/BLK/●	£397

Pillar Poseur

				Standard pillar	Cable managed pillar*	
Round 	White, black or raw, round or square base, MFC top, H: 1100mm	600mm dia	ALB/MPP/600/□/RB/● ALB/MPP/600/□/SB/●	£623	£705	
		700mm dia	ALB/MPP/700/□/RB/● ALB/MPP/700/□/SB/●	£623	£706	
		800mm dia	ALB/MPP/800/□/RB/● ALB/MPP/800/□/SB/●	£663	£746	
		900mm dia	ALB/MPP/900/□/RB/● ALB/MPP/900/□/SB/●	£666	£749	
		1000mm dia	ALB/MPP/1000/□/RB/● ALB/MPP/1000/□/SB/●	£670	£753	
		1100mm dia	ALB/MPP/1100/□/RB/● ALB/MPP/1100/□/SB/●	£678	£761	
		1200mm dia	ALB/MPP/1200/□/RB/● ALB/MPP/1200/□/SB/●	£713	£796	
		Square 	600x600mm	ALB/MPP/6060/□/RB/● ALB/MPP/6060/□/SB/●	£495	£579
			700x700mm	ALB/MPP/7070/□/RB/● ALB/MPP/7070/□/SB/●	£515	£598
			800x800mm	ALB/MPP/8080/□/RB/● ALB/MPP/8080/□/SB/●	£515	£598
900x900mm	ALB/MPP/9090/□/RB/● ALB/MPP/9090/□/SB/●		£530	£614		

* Add /CMP at end of code for cable managed pillar base.
 Replace □ with metalwork colour: WH, BLK or RAW.
 Replace ● with MFC finish.
 Contrasting edge on top will be FOC. Acrylic ply edge will carry a 12% upcharge to RRP.





PRODUCT NAME	DESCRIPTION	DIMENSIONS	PRODUCT CODE	RRP		
Box Poseur		White, black or raw, Single MFC top, H: 1100mm	1000mm	ALB/MP/1070/□/● ALB/MP/1080/□/●	£721	£726
			1200mm	ALB/MP/1270/□/● ALB/MP/1280/□/●	£742	£747
			1400mm	ALB/MP/1470/□/● ALB/MP/1480/□/●	£767	£772
			1500mm	ALB/MP/1570/□/● ALB/MP/1580/□/●	£768	£772
			1600mm	ALB/MP/1670/□/● ALB/MP/1680/□/●	£768	£773
			1800mm	ALB/MP/1870/□/● ALB/MP/1880/□/●	£838	£845
			2000mm	ALB/MP/2070/□/● ALB/MP/2080/□/●	£894	£899
			2200mm	ALB/MP/2270/□/● ALB/MP/2280/□/●	£894	£900
			2400mm	ALB/MP/2470/□/● ALB/MP/2480/□/●	£1,506	£1,513
			2800mm	ALB/MP/2870/□/● ALB/MP/2880/□/●	£1,556	£1,563
			3000mm	ALB/MP/3070/□/● ALB/MP/3080/□/●	£1,557	£1,564
			3200mm	ALB/MP/3270/□/● ALB/MP/3280/□/●	£1,559	£1,565
			3600mm	ALB/MP/3670/□/● ALB/MP/3680/□/●	£1,615	£1,710
			4000mm	ALB/MP/4070/□/● ALB/MP/4080/□/●	£1,725	£1,818
			4400mm	ALB/MP/4470/□/● ALB/MP/4480/□/●	£1,727	£1,819
4500mm (3-piece)	ALB/MP/4570/□/● ALB/MP/4580/□/●	£2,218	£2,228			
4800mm (3-piece)	ALB/MP/4870/□/● ALB/MP/4880/□/●	£2,220	£2,229			
	White, black or raw, Multi MFC top, H: 1100mm	2400mm	ALB/MP/2470/□/● ALB/MP/2480/□/●	£1,506	£1,513	
		2800mm	ALB/MP/2870/□/● ALB/MP/2880/□/●	£1,556	£1,563	
		3000mm	ALB/MP/3070/□/● ALB/MP/3080/□/●	£1,557	£1,564	
		3200mm	ALB/MP/3270/□/● ALB/MP/3280/□/●	£1,559	£1,565	
		3600mm	ALB/MP/3670/□/● ALB/MP/3680/□/●	£1,615	£1,710	
		4000mm	ALB/MP/4070/□/● ALB/MP/4080/□/●	£1,725	£1,818	
		4400mm	ALB/MP/4470/□/● ALB/MP/4480/□/●	£1,727	£1,819	
		4500mm (3-piece)	ALB/MP/4570/□/● ALB/MP/4580/□/●	£2,218	£2,228	
		4800mm (3-piece)	ALB/MP/4870/□/● ALB/MP/4880/□/●	£2,220	£2,229	

Replace □ with metalwork colour: WH, BLK or RAW.

Replace ● with MFC finish.

Single top table - Contrasting edge on top will be FOC. Acrylic ply edge will carry a 12% upcharge to RRP.

Multi top table - Contrasting & Acrylic ply edge will carry a 25% upcharge to RRP.

Cloud Poseur	WIDTH	RRP / TOP DEPTH		
		800mm	1000mm	1200mm
Single top H: 1100mm 	1000mm	£1,075	£1,320	£1,336
	1200mm	£1,085	£1,333	£1,428
	1400mm	£1,110	£1,359	£1,469
	1500mm	£1,119	£1,370	£1,482
	1600mm	£1,126	£1,379	£1,490
	1700mm	£1,180	£1,431	£1,553
	1800mm	£1,184	£1,440	£1,561
	2000mm	£1,195	£1,453	£1,573
	2200mm	£1,215	£1,480	£1,601
	2400mm	£1,243	£1,508	£1,651
Multi top H: 1100mm 	2800mm	-	£2,555	£2,571
	3000mm	-	£2,572	£2,588
	3200mm	-	£2,596	£2,613
	3400mm	-	£2,681	£2,698
	3600mm	-	£2,714	£2,730
	3800mm	-	£2,743	£2,759
	4000mm	-	£2,839	£2,855
	4200mm*	-	£3,522	£3,541
	4500mm*	-	£3,545	£3,564
	4800mm*	-	£3,595	£3,615
	5100mm*	-	£3,725	£3,744
	5400mm*	-	£3,762	£3,781

* 3-piece top

Round H: 1100mm 	800mm dia	£990
	900mm dia	£993

Natural oak legs with MFC top as standard. Black stained oak legs available with a 5% upcharge to RRP.
 Metalwork available in WH, BLK or RAW.
 Single top table - Contrasting edge on top will be FOC. Acrylic ply edge will carry a 12% upcharge to RRP.
 Multi top table - Contrasting & Acrylic ply edge will carry a 25% upcharge to RRP.

Contact us for product code.



Functional

SWIVEL SEATING

CONFERENCE CHAIRS





VISITOR & RECEPTION

STOOLS & BEAM SEATING





Functional

Swivel seating

SWIVEL SEATING



PRODUCT NAME	DESCRIPTION	DIMENSIONS/OPTIONS	FINISH	RRP
College				
CG50 	Student swivel chair, Height adjustable black base Shell manufactured from 50% recycled materials	W: 450mm (640mm with tablet) D: 515mm Seat (H): 425-490mm Seat (W): 450mm Seat (D): 400mm Back (H): 430mm	Red, Lemon yellow, Orange, Pale blue, Green or Warm grey	£112
CG55 	Student swivel chair, Orbital LH/RH writing tablet, Includes pen tray, Height adjustable black base Shell manufactured from 50% recycled materials			£295
	Options	Upholstered seat pad	Band 0 Band 1 Band 2 Band 3 Band 4	+£29 +£38 +£45 +£55 +£65
		Polished aluminium base		+£53
CG60 	Student swivel chair, Storage, White base Shell manufactured from 50% recycled materials	W: 635mm D: 635mm Seat (H): 475mm Seat (W): 450mm Seat (D): 400mm Back (H): 430mm	Red, Lemon yellow, Orange, Pale blue, Green or Warm grey	£198
CG65 	Student swivel chair, Orbital LH/RH writing tablet, Includes pen tray, Storage, White base Shell manufactured from 50% recycled materials			£348
	Options	Upholstered seat pad	Band 0 Band 1 Band 2 Band 3 Band 4	+£29 +£38 +£45 +£55 +£65
Skolar				
SK2 	Student swivel chair, Fixed back, Gas lift and no removable parts, Height adjustable, Black base	W: 460mm Seat (H): 410-520mm Seat (W): 460mm Seat (D): 430mm Back (H): 400mm	Band 0 Band 1 Band 2 Band 3 Band 4 Band 5	£149 £164 £180 £199 £219 £293

SWIVEL SEATING



PRODUCT NAME	DESCRIPTION	DIMENSIONS/OPTIONS	FINISH	RRP
Industrial				
IND3 	Heavy duty P.U. stool, Height adjustable black base	Seat (H): 440-630mm Seat dia: 350mm	Black PU	£130
T300S 	Upholstered stool, Height adjustable black base	Seat (H): 420-530mm Seat dia: 440mm	Band 0	£130
			Band 1	£139
			Band 2	£149
			Band 3	£160
			Band 4	£172
IND5 	Heavy duty P.U. chair, Operator mechanism, Height adjustable black base	W: 450mm Seat (H): 390-540mm Seat (W): 450mm Seat (D): 410mm Back (H): 360mm	Black PU	£239
IND5A 	Heavy duty P.U. chair with arms, Operator mechanism, Height adjustable black base	W: 560mm Seat (H): 390-540mm Seat (W): 450mm Seat (D): 410mm Back (H): 360mm	Black PU	£263
IND5ADJ 	Heavy duty P.U. chair, Height adjustable arms, Operator mechanism, Height adjustable black base	W: 625mm Seat (H): 390-540mm Seat (W): 450mm Seat (D): 410mm Back (H): 360mm	Black PU	£285
	Options	Height adjustable footring, High gas lift and glides: IND4: Seat (H): 545-770mm D300S: Seat (H): 560-810mm IND6/IND6A/IND6ADJ: Seat (H): 545-795mm		+£71

Functional



Conference chairs



PRODUCT NAME	DESCRIPTION	DIMENSIONS/OPTIONS	FINISH	RRP
Salford				
L4 	Stackable chair (up to 8), 19mm square tube, Black frame 15 year frame guarantee	W: 455mm D: 560mm Seat (H): 470mm Seat (W): 420mm Seat (D): 420mm Back (H): 450mm	Band 0	£108
			Band 1	£118
			Band 2	£127
			Band 3	£140
			Band 4	£152
L5 	Stackable chair (up to 8), 19mm square tube, Black frame 15 year frame guarantee	W: 455mm D: 560mm Seat (H): 470mm Seat (W): 420mm Seat (D): 420mm Back (H): 450mm	Band 0	£117
			Band 1	£127
			Band 2	£136
			Band 3	£148
			Band 4	£161
Options		Non standard frame colour (MOQ 5 units)		+£13
		Linking		+£12

Gloucester

G1 	Stackable chair (up to 6), Black frame	W: 530mm D: 560mm Seat (H): 470mm Seat (W): 460mm Seat (D): 420mm Back (H): 370mm	Band 0	£122
			Band 1	£136
			Band 2	£150
			Band 3	£167
			Band 4	£184
Options		Non standard frame colour (MOQ 5 units)		+£13
G12 	Stackable chair (up to 4), Lozange-shaped back, Black frame	W: 515mm D: 560mm Seat (H): 480mm Seat (W): 445mm Seat (D): 450mm Back (H): 360mm	Band 0	£159
			Band 1	£173
			Band 2	£186
			Band 3	£203
			Band 4	£220
G14 	Stackable chair (up to 4) with arms, Lozange-shaped back, Black frame	W: 590mm D: 560mm Seat (H): 480mm Seat (W): 445mm Seat (D): 450mm Back (H): 360mm	Band 0	£191
			Band 1	£205
			Band 2	£218
			Band 3	£235
			Band 4	£252
Options		Non standard frame colour (MOQ 5 units)		+£13
		Chrome plate frame		+£29
		Castors		+£68

PRODUCT NAME	DESCRIPTION	DIMENSIONS/OPTIONS	FINISH	RRP
Gloucester				
G15 	Stackable cantilever chair (up to 4), Lozange-shaped back, Black frame	W: 530mm D: 560mm Seat (H): 480mm Seat (W): 445mm Seat (D): 450mm Back (H): 360mm	Band 0	£260
			Band 1	£274
			Band 2	£287
			Band 3	£304
			Band 4	£321
Options		Non standard frame colour (MOQ 5 units)		+£13
		Chrome plate frame		+£29







Exceed				
EX8 	Stackable chair (up to 4), Black frame	W: 570mm D: 530mm Seat (H): 470mm Seat (W): 480mm Seat (D): 460mm Back (H): 370mm	Band 0	£178
			Band 1	£195
			Band 2	£212
			Band 3	£234
			Band 4	£256
			Band 5	£339
			Band 6	£401
EX9 	Stackable chair (up to 4), Black frame	W: 570mm D: 570mm Seat (H): 470mm Seat (W): 480mm Seat (D): 460mm Back (H): 390mm	Band 0	£197
			Band 1	£219
			Band 2	£240
			Band 3	£267
			Band 4	£294
			Band 5	£395
			Band 6	£470
Options		Non standard frame colour (MOQ 5 units)		+£13

Skolar				
SK10A 	Stackable Heavy duty chair, Black frame For use by persons up to 200kg, Tested to BS EN15373, 15 year frame guarantee	W: 550mm D: 600mm Seat (H): 470mm Seat (W): 430mm Seat (D): 500mm Back (H): 380mm	Band 0	£224
			Band 1	£235
			Band 2	£247
			Band 3	£262
			Band 4	£276
			Band 5	£332
SK10 	Options	Chair without arms W: 490mm		-£28
		Non standard frame colour (MOQ 5 units)		+£13
		Dual locating, rigid steel linking		+£36

Functional



Visitor & Reception



PRODUCT NAME	DESCRIPTION	DIMENSIONS/OPTIONS	FINISH	RRP
Saltford 25				
S15AS 	Stackable armchair (up to 4), Solid beech arms polished with anti bacterial lacquer, 25mm square tube chair, Black frame 15 year frame guarantee	W: 570mm D: 530mm Seat (H): 470mm Seat (W): 420mm Seat (D): 420mm Back (H): 330mm	Band 0	£144
			Band 1	£156
			Band 2	£168
			Band 3	£182
			Band 4	£197
S15 	Options	Chair without arms W: 470mm		-£45
			Non standard frame colour (<i>MOQ 5 units</i>)	+£13
			Linking (<i>S15 only</i>)	+£12
A13 	Low level chair, 25mm square tube, Black loop frame	W: 520mm D: 660mm Seat (H): 410mm Seat (W): 520mm Seat (D): 450mm Back (H): 410mm	Band 0	£186
			Band 1	£208
			Band 2	£229
			Band 3	£256
			Band 4	£283
A2 	Low level chair, Solid beech arms polished with anti bacterial lacquer, 25mm square tube, Black frame	W: 630mm D: 670mm Seat (H): 410mm Seat (W): 520mm Seat (D): 450mm Back (H): 400mm	Band 0	£247
			Band 1	£266
			Band 2	£286
			Band 3	£310
			Band 4	£334
A1 	Options	Chair without arms W: 520mm		-£88
			Non standard frame colour (<i>MOQ 5 units</i>)	+£13



PRODUCT NAME	DESCRIPTION	DIMENSIONS/OPTIONS	FINISH	RRP			
Radstock							
R2 	Stackable chair (up to 4), Black PU arms 15 year frame guarantee	W: 625mm D: 580mm Seat (H): 480mm Seat (W): 480mm Seat (D): 460mm Back (H): 380mm	Band 0	£185			
			Band 1	£201			
			Band 2	£216			
			Band 3	£236			
			Band 4	£255			
			Band 5	£329			
R1 	Options	Chair without arms W: 520mm	-£35				
R1W 					Chair without arms, Removable white MFC LH or RH writing tablet - extra cost, in addition to R2 pricing W: 520mm Tablet: 330x330mm	+£78	
					Non standard frame colour (MOQ 5 units)	+£13	
		Linking for R1	+£12				
R5 	2-seater reception chair, Upholstered arms, Black frame 15 year frame guarantee	W: 1270mm D: 700mm Seat (H): 420mm Seat (W): 1130mm Seat (D): 490mm Back (H): 450mm	Band 0	£518			
			Band 1	£565			
			Band 2	£611			
			Band 3	£670			
			Band 4	£728			
			Band 5	£950			
R4 	Reception chair, Upholstered arms, Black frame 15 year frame guarantee	W: 720mm D: 700mm Seat (H): 420mm Seat (W): 550mm Seat (D): 490mm Back (H): 450mm	Band 0	£273			
			Band 1	£297			
			Band 2	£320			
			Band 3	£349			
			Band 4	£378			
			Band 5	£489			
R3 	Options	Chair without arms W: 610mm	-£62				
						Non standard frame colour (MOQ 5 units)	+£13
						Linking for R3	+£12

PRODUCT NAME	DESCRIPTION	DIMENSIONS/OPTIONS	FINISH	RRP
Radstock				
R6 	High-back lounge chair, Upholstered arms, Black frame 15 year frame guarantee	W: 720mm D: 740mm Seat (H): 420mm Seat (W): 550mm Seat (D): 490mm Back (H): 790mm	Band 0	£480
			Band 1	£518
			Band 2	£557
			Band 3	£606
			Band 4	£655
			Band 5	£839
			Options	Non standard frame colour (MOQ 5 units)
Additional frame height up to 120mm		+£80		



Westwood

W11 	Stackable chair with arms, Polished beech laminate frame with anti bacterial lacquer	W: 550mm D: 625mm Seat (H): 480mm Seat (W): 420mm Seat (D): 490mm Back (H): 405mm	Band 0	£237
			Band 1	£253
			Band 2	£268
			Band 3	£288
			Band 4	£307
			Band 5	£381
			Band 6	£435
W10 	Options	Chair without arms	Same as above	

			Medium back W55	High back W65	
W55/W65  	Reception chair with ams, Solid beech frame with anti bacterial lacquer	W: 620mm D: 640mm (W55) D: 680mm (W65) Seat (H): 430mm Seat (W): 520mm Seat (D): 460mm Back (H): 460mm (W55) Back (H): 550mm (W65)	Band 0	£504	£539
			Band 1	£538	£577
			Band 2	£572	£615
			Band 3	£614	£663
			Band 4	£657	£711
			Band 5	£819	£893
			Band 6	£938	£1,027
W50/W60 	Options	Chair without arms W: 570mm	-£55		

PRODUCT NAME	DESCRIPTION	DIMENSIONS/OPTIONS	FINISH	RRP
Cyrus				
C255 	2-seater reception chair, Solid beech arms polished with anti bacterial lacquer, Oversized rectangular, Black tube frame 15 year frame guarantee	W: 1160mm D: 660mm Seat (H): 440mm Seat (W): 1040mm Seat (D): 460mm Back (H): 450mm	Band 0	£660
			Band 1	£723
			Band 2	£785
			Band 3	£863
			Band 4	£940
			Band 5	£1,236
			Band 6	£1,454
C55 	Reception chair, Solid beech arms polished with anti bacterial lacquer, Oversized rectangular, Black tube frame 15 year frame guarantee	W: 650mm D: 660mm Seat (H): 440mm Seat (W): 520mm Seat (D): 460mm Back (H): 450mm	Band 0	£365
			Band 1	£396
			Band 2	£427
			Band 3	£466
			Band 4	£505
			Band 5	£653
			Band 6	£762
C50 	Options	1-seater chair without arms W: 570mm	-£68	
			Non standard frame colour (MOQ 5 units)	+£13
			Additional frame height up to 120mm	+£40

Cyrus bariatric

			Medium back CHL55	High back CHL65	
CHL55/CHL65 	Reception chair, solid beech arms polished with anti bacterial lacquer, Oversized rectangular, Black tube frame Certified for loads up to 50 stone (317.5kg) 15 year frame guarantee	W: 850mm D: 660mm Seat (H): 440mm Seat (W): 720mm Seat (D): 460mm Back (H): 450mm (CHL55) Back (H): 550mm (CHL65)	Band 0	£670	£722
			Band 1	£711	£763
			Band 2	£752	£804
			Band 3	£803	£855
			Band 4	£854	£906
			Band 5	£1,048	£1,100
			Band 6	£1,191	£1,243
CHL50/CHL60 	Options	Chair without arms W: 770mm	-£83		
			Non standard frame colour (MOQ 5 units)	+£13	
			Additional frame height up to 120mm	+£40	
			Memory foam seat	+£120	

Functional

Stools & Beam seating

PRODUCT NAME	DESCRIPTION	DIMENSIONS/OPTIONS	FINISH	RRP
Salford				
C1 	Stool with back, 19mm square tube frame with epoxy polyester coating, Black frame 15 year frame guarantee	W: 370mm D: 410mm Seat (H): 760mm Seat (W): 370mm Seat (D): 345mm Back (H): 320mm	Band 0	£109
			Band 1	£119
			Band 2	£129
			Band 3	£141
			Band 4	£153
			Options	Non standard frame colour (<i>MOQ 5 units</i>)



Additional Information

ELECTRICS



FABRICS BANDS

GENERAL TERMS

TERMS & CONDITIONS

OUR CONNECTED WORLD

As workspace culture evolves, the need to facilitate the seamless use of mobile devices from the comfort of our seating is an absolute given. Connections for power, charging and presentations, unobtrusively and conveniently positioned, enable individuals or groups to find comfortable, private or communal places to work. To this end, throughout a number of our ranges we offer optional power modules. As befits the quality of our furniture, the power modules we offer come from the recognised leaders in this field. UK company, Sourcetec are experts in designing and manufacturing power and data distribution solutions. They have been designing their own products in the UK for many years. Their products can be found in use all over the world in environments as diverse as industrial, commerce, retail, hospitality, education, healthcare and even home.

PRODUCT NAME	DESCRIPTION	FINISH	RRP
Power modules integrated with upholstery For ease of choice when specifying our upholstered seating and booth products, we offer from stock, 3 elegantly designed, Sourcetec power modules. Each module integrates seamlessly within the upholstery design. They come with a detachable, 3m trailing mains lead with a 13 amp, UK 3 pin plug. If you have a power module requirement not met by our stock offering then please speak to us and we will be able to offer solutions from the wider Sourcetec range.			
Elio 	Elio is an elegant, white, 90mm diameter unit that is flush mounted within the upholstered face of a seating or media unit. It provides a standard, fused, UK 13 amp power socket plus 3 USB fast charging sockets, 1 type-A, and 2 type-C, delivering 3 amps	White	£148
Qubit 	This module is a surface mounted, 100 watt unit contained within a robust, white plastic casing. We offer Qubit for use on seating products where the design does not allow for the flush mounting and the internal accommodation of a module and its cables. Qubit delivers ultra fast charging through both a USB and a type-C port	White	£238
Nano 	Nano is a stylish black cased table top mounted power module. It has a standard fused UK 13 amp power socket plus 2 USB fast charging sockets, type-A, and type-C.	Black	£86



Note about Media Units - VDU screens and screen mounting brackets

We do not supply or fit VDU screens or screen mounting brackets. The front panel of our media units is constructed from a 9mm ply board. This facilitates the easy and secure fixing of a screen mounting bracket by the use of suitably sized, self-tapping wood screws. To avoid snagging the fabric we recommend that the hole positions are marked and then a small cut is made in the fabric before the screw is driven in.

PRODUCT NAME	DESCRIPTION	FINISH	RRP
--------------	-------------	--------	-----

Power modules for tables & desks

UNO modules come with a detachable, 3m trailing mains lead with a 13 amp, UK 3 pin plug.

<p>UNO A&C/100W</p> 	<p>UNO A&C/100W is a desktop mounted, multi output, high capacity module ideal for multiple users. In black or white casing it clamps to the edge of a top and offers dual 13 amp sockets and dual fastcharge via. USB A&C. Plus a type-C Ultra fast charge, capable of charging a laptop to 40% in 8 minutes</p>	<p>White</p> <hr/> <p>Black</p>	<p>£294</p>
<p>UNO A&C</p> 	<p>UNO A&C is a desktop mounted, multi output module ideal for multiple users. In black or white casing it clamps to the edge of a top and offers dual 13 amp sockets and dual USB fastcharge, A&C</p>	<p>White</p> <hr/> <p>Black</p>	<p>£143</p>

	BAND 0	BAND 1	BAND 2	BAND 3	BAND 4	BAND 5	BAND 6	BAND 7
AGUA	Chea	Buro	Aries	Alberta Hyde	7			
	Lavoro	Lavoro Crib 5	Buro Crib 5	Aura UV	Mystique			
		Libra	Cartella Crib 5	Carmina				
		Linetta	Cashmir	Furnisoft Breathable				
		Paintpot	Fusion	Oregon Hyde				
		Stol	Juno	Snowdon				
		Task	Kontor Crib 5	Stretch				
			Lunar					
			Nova					
			Parody					
			Sark					
			Taurus					
			Tones					
AMBLA		Richmond	Exmoor					
			Munro					
			Tinto					
			Wild Heather					
			York Weave					
CAMIRA	Advantage	Canopy	Aspect	Aquarius	24/7 Flax	Craggan Flax		
	Citadel	Chateau	Main Line Flax	Blazer	24/7 Plus	Deca		
	Era	Manhattan	Main Line Plus	Halcyon Aspen	Acrobat	Synergy Quilt		
	Gravity	Urban	Manila	Halcyon Blossom	Hebden	Zap		
	Phoenix	Vita	Patina	Halcyon Cedar	Regent			
	Rivet	X2	Replay	Hemp	Silk			
	Target	Xtreme	Xtreme CS	Hi-Tech	Track			
				Intervene Plain	Yoredale			
				Intervene Texture				
				Kyoto				
				Mainline Twist				
				Oceanic				
				Sumi				
			Synergy					
CHIEFTAIN	Trimcell Classic	Just Colour	Casco	Carousel	Protect 7			
	Trimcell Legend	Just Patterns	Lionella	Earthy				
		Pasha	Multistretch	Ravel				
			Riviera					

	BAND 0	BAND 1	BAND 2	BAND 3	BAND 4	BAND 5	BAND 6	BAND 7
SUNBURY			Bathurst					
			Vintage FR Faux Suede					
SVENSSON*						Easy	Accessoire	
						Heritage	Be On	
						Tone	Debut	
							Harper	
							Moss	
							Rami	
							Semi	
							Urban	
VESCOM				Furka Plus	Leone Plus	Ponza		
VILLA NOVA					Geneva FR			
WARWICK		Keylargo	Koki	Krayola				
YARN COLLECTIVE							Albee	Ismay Boucle
								Jack
YARNWOOD*		Dollaro						Leather-Style Range

*MOQs apply to leathers and fabric suppliers with high delivery fees, contact our Sales team to discuss.
 This list is for guidance only and not exhaustive. If the fabric you are after is not above, please send your enquiry to the Sales team.

Guarantees

All of our chairs come with a 5 year structural guarantee, excluding fair wear and tear, and damage or failure caused by misuse. The tubular steel frames on the MeMe, Ultra, Saltford 19 & 25, Radstock, Cyrus, Cyrus Bariatric, Beam and Versit Beam ranges and on the Skolar SK10 and SK10A chairs are structurally guaranteed for 15 years. The guarantee applies for use up to 8 hours a day by users up to 150kg. All exceptions to that standard, are listed in the table below:

Any chair that requires repair under the terms of our guarantee will be collected from and returned to the supplying dealer on our next available transport.

Product range or chair	Limits to intensity of use and user weight to maintain warranty cover
Ergonomic Task 24	24/hour per day use by users up to 150Kg in weight
Posturemax 200	24/hour per day use by users up to 200Kg in weight
Cyrus Bariatric	24/hour per day use by users up to 350Kg in weight
Skolar SK10, SK10A, SK10W skid framed stacking chair	24/hour per day use by users up to 200Kg in weight
Gloucester G1 stacking chair	8 hour per day use by users up to 110Kg in weight
Versit range	8 hour per day use by users up to 110Kg in weight
Scout	8 hour per day use by users up to 110kg in weight

Gas Lifts

All of the swivel chairs in this guide are fitted with a gas lift for easy height adjustment. These are suitable for people up to 150kg in weight. The gas lifts fitted to the Posturemax 200 range chairs are suitable for users up to 200kg.

Ordering

To give accuracy a sporting chance, we only accept written orders. We'll acknowledge the order as soon as possible and request you check the acknowledgement thoroughly to ensure we've accurately interpreted your requirements. If not, please contact us immediately, as we usually start cutting within a day of receiving an order. Alterations or cancellations beyond 24 hours of receipt of order, will incur a charge.

This guide has an image for each product along with a unique product code to ensure you know what you are ordering.

The appearance of the mechanisms on swivel chairs, pictured within this guide, are representative only and may differ slightly depending on the type of mechanism required.

Options for each product are listed within the RRP's, if any are required, please make that clear on your order.

Whilst we have made great efforts to ensure the price list includes accurate data, it may contain a number of errors or missing information. If you are in doubt, please check before ordering.

Deliveries

Prices in this guide include delivery to our nationwide dealer network subject to a minimum net invoice value of £250. On request, we can undertake tail gate only deliveries to your customer's premises. We will work out the most cost-effective way to do this for you based on our regular delivery routes.

Sample Chairs

We're always delighted to send sample chairs to demonstrate the comfort and craftsmanship we're so proud of. Samples are invoiced on delivery and a credit note issued when the chair is returned in the same condition within 15 working days.

VAT & Measurements

All prices are in Pounds Sterling and subject to VAT at the prevailing rate. All measurements are in millimetres and are approximate. They can vary due to option specification.

Fabric, Leather, Wood & Foam

While we take every care to accurately represent the colours of the fabrics in this price guide, the printing process can sometimes alter the colour depiction so we'd always recommend ordering a sample before making a fabric choice. Leather and wood naturally exhibit grain and colour variations. It's part of their charm as organic materials, adding personality and character to our pieces.

We use Combustion Modified, High Resilient foam in all of our products for comfort, durability and to meet fire safety legislation.

1. For the purposes of these Conditions the term “the Company” shall mean Summit Chairs Limited, the term “the Goods” shall mean such chairs or other goods as are manufactured and sold by the Company and the term “the Buyer” shall mean the purchaser of the goods.

2. These Conditions apply to all business transactions between the Company and the Buyer and shall be the sole contractual basis of any sale agreement between them.

3. Orders are accepted subject only to these Conditions of Sale and to the exclusion of all other terms and conditions including any terms or conditions which may purport to apply under any purchase order, confirmation of order or similar document. Any variation to these Conditions (including any special conditions agreed between the parties) shall be inapplicable and of no effect whatever unless agreed in writing by the Company

4. All prices in GBP exclusive of VAT. This price list supersedes all previous price lists. Whilst we have made great efforts to ensure the price list includes accurate data, it may contain a number of errors or missing information. If you are in doubt, please check before ordering. Special quotations are valid for 30 days unless otherwise agreed. Items and finishes included in this price list are standard. Prices for bespoke options are available upon request. Summit 1977 reserves the right to alter the design of its products and discontinue products or finishes at any time without direct notification to you.

5. Payment by the Buyer shall be made to the Company by the 20th day of the month that follows the date of the invoice and time for payment shall be of the essence. The Company shall charge interest on invoices that shall become overdue to be paid by the Buyer from day to day until the date of payment at a rate of 2% above HSBC plc’s base rate from time to time in force and shall accrue at such rate after as well as before any judgement.

6. All terms and conditions and warranties (whether implied or made expressly) whether by the Company or its servants or agents or otherwise (other than those express warranties set out in the current edition of the Company’s specification) relating to the quality and/or fitness for purpose of the goods or any of the goods are excluded.

7. The Goods shall be manufactured and supplied in accordance with the description contained within the Company’s specification and manufactured in accordance with all applicable British Standards which relate specifically to the goods.

8. The Company may from time to time make changes in the specification of the goods as may be necessary such as to comply with any applicable or statutory requirements or which do not materially affect the quality or fitness for purpose of the goods.

9. The Company shall deliver the goods to an address and during a day (within normal working hours) agreed with the Buyer. In the event that the Buyer is unable to accept such delivery the Company shall have the right to charge to and recover from the Buyer all costs incurred in connection therewith as if the same were a debt.

10. The Buyer shall take delivery of the goods tendered by the Company notwithstanding that the quantity so delivered shall be less than the quantity purchased provided that such discrepancy in quantity shall not exceed 40% and in which event the price shall be adjusted pro rata to the discrepancy.

11. The Buyer is under obligation to inspect the goods upon receipt and shall notify the Company of any damage to the goods within three days thereof.

12. The Company shall be under no liability whatever to the Buyer for any indirect loss and/or expense (including loss of profit) suffered by the Buyer arising out of a breach by the Company of any sale agreement. In the event of any such breach by the Company the remedies of the Buyer shall be limited to damages. Under no circumstances shall the liability of the Company exceed the price of the Goods.

13. In spite of delivery having been made property in the goods shall not pass to the Buyer until the Buyer shall have paid to the Company the price plus VAT in full and no other sums whatever shall be due from the Buyer to the Company. The Buyer holds the goods in a fiduciary capacity as bailee for the Company. The Buyer agrees to keep apart and separately to identify (as belonging to the Company) all goods owned by the Company in its possession. The Company reserves the right of disposal of any of its property and shall be at liberty to retake possession of the same or any part thereof and for that purpose enter into any premises of the Buyer until the goods delivered to the Buyer by the Company have been paid for in full. The Buyer is authorised to sell or to use the goods as a bailee of the Company. If the goods or any part thereof are sold

then if the property in the goods is within the Company pursuant to these terms property shall pass from the Company to the new buyer. In the event that the Buyer receives from any person payment in respect of the goods or any part thereof the Buyer shall receive and hold such monies on behalf of the Company and keep them separate and apart until the Company has been paid in full for the goods comprised in any agreement between the Company and the Buyer.

14. The Buyer shall insure and keep insured the goods to the full price against “all risks” to the reasonable satisfaction of the Company until the date that property in the goods passes from the Company. If the Buyer fails so to do and without prejudice to the other rights of the Company all sums whatever owing to the Company by the Buyer shall forthwith become due and payable.

15. Any sale agreement between the Company and the Buyer may be subject to cancellation by the Company by reason of an Act of God, force majeure or other cause beyond the control of the Company.

16. The Company guarantees that the goods are fit for the purpose for which they are intended and further guarantees the goods to be free from defects in materials and workmanship for a period of five years for structural parts under normal, 8 hour per day use excepting fair wear and tear and damage or malfunction caused by misuse. User weight limits and some exceptions to hours of use apply. These limits and exceptions are set out within the Guarantee section of our current Retail Price list. The Company undertakes to repair the goods or any part thereof which proves to be defective under normal conditions of use. Any chairs requiring repair within the guarantee period will be collected from and returned to the Buyer on our next available transport.

17. All goods sold in retail packaging may be resold by the Buyer in the packaging supplied by the Company and in no case may any trade mark other than those applied by the Company be marked on or applied in relation to the goods without prior agreement of the company. No right or licence is granted under any sale agreement to the Buyer under any patent, trade mark, copyright, design right or other intellectual property right except the right to use or resell the goods.

18. Any sale agreement between the Company and the Buyer shall be subject to the laws of England and Wales and all disputes arising out of such sale agreements shall be subject to the jurisdiction of the courts of England and Wales.

19. Change/cancellation of orders – You may amend or cancel an order, or contact Summit 1977 with corrections to the order confirmation, within 24 hours of the issue of the order acknowledgement (Grace Period) by notifying us in writing of the requested amendment, cancellation or correction. It is your responsibility to check the order acknowledgement and report any errors within the Grace Period. No amendment or cancellation of the order, or change to the order acknowledgement, may be made after the expiry of the Grace Period except with the written consent of Summit 1977. Where consent is given to such amendment or cancellation after the expiry of the Grace Period, Summit 1977 may require you to pay additional charges as a condition of its consent.

20. Conditions of delivery – Please enquire about stock levels before ordering. Our standard delivery is free of charge for orders with a value of £1000.00 net or above – tailgate between 9am–5pm Monday to Friday, to one UK mainland address. Deliveries are made on set days to set areas which will be confirmed on your sales acknowledgement. If there are vehicle restrictions on direct deliveries then we reserve the right to charge for additional vehicles if they are required. If your normal delivery day falls on a Bank Holiday then it will be rescheduled for the same week with a delivery confirmation sent prior confirming which day it will take place. Delivery of orders under £1000.00 will be charged at £50.00 unless agreed otherwise. Deliveries to Ireland or Europe are P.O.A. We offer a delivery & installation service if required, P.O.A.

21. It is the purchaser’s responsibility to ensure that building access is adequate before ordering: furniture cannot be cut down or segmented once manufactured. Should it be apparent that goods are damaged/faulty in any way, the recipient/customer must inform the supplier within 24 hours of receipt. Extended delivery times may occur due to circumstances out of our control. Summit 1977 have the right to discontinue products or finishes at any time without direct notification to you.



Talk to one of our experts
to find the furniture that
fits your *inspiring space*.

