



832-206-9949

www.texasedgeinspect.com

matt@texasedgeinspect.com



INSPECTED FOR

Donald P Cunningham
7898 Weeping Willow Ct.
Houston, TX 77057

August 6, 2021

PROPERTY INSPECTION REPORT

Prepared For: Donald P Cunningham
(Name of Client)

Concerning: 7898 Weeping Willow Ct., Houston, TX 77057
(Address or Other Identification of Inspected Property)

By: Matthew Brading, Lic #22654 08/06/2021
(Name and License Number of Inspector) (Date)

(Name, License Number of Sponsoring Inspector)

PURPOSE, LIMITATIONS AND INSPECTOR / CLIENT RESPONSIBILITIES

This property inspection report may include an inspection agreement (contract), addenda, and other information related to property conditions. If any item or comment is unclear, you should ask the inspector to clarify the findings. It is important that you carefully read ALL of this information.

This inspection is subject to the rules ("Rules") of the Texas Real Estate Commission ("TREC"), which can be found at www.trec.texas.gov.

The TREC Standards of Practice (Sections 535.227-535.233 of the Rules) are the minimum standards for inspections by TREC-licensed inspectors. An inspection addresses only those components and conditions that are present, visible, and accessible at the time of the inspection. While there may be other parts, components or systems present, only those items specifically noted as being inspected were inspected. The inspector is NOT required to turn on decommissioned equipment, systems, utility services or apply an open flame or light a pilot to operate any appliance. The inspector is NOT required to climb over obstacles, move furnishings or stored items. The inspection report may address issues that are code-based or may refer to a particular code; however, **THIS IS NOT A CODE COMPLIANCE INSPECTION** and does NOT verify compliance with manufacturer's installation instructions. **THE INSPECTION DOES NOT IMPLY INSURABILITY OR WARRANTABILITY OF THE STRUCTURE OR ITS COMPONENTS.** Although some safety issues may be addressed in this report, **THIS REPORT IS NOT A SAFETY / CODE INSPECTION**, and the inspector is NOT required to identify all potential hazards.

In this report, the inspector shall indicate, by checking the appropriate boxes on the form, whether each item was inspected, not inspected, not present or deficient and explain the findings in the corresponding section in the body of the report form. The inspector must check the Deficient (D) box if a condition exists that adversely and materially affects the performance of a system or component or constitutes a hazard to life, limb or property as specified by the TREC Standards of Practice. General deficiencies include inoperability, material distress, water penetration, damage, deterioration, missing components, and unsuitable installation. Comments may be provided by the inspector whether or not an item is deemed deficient. The inspector is not required to prioritize or emphasize the importance of one deficiency over another.

Some items reported may be considered life-safety upgrades to the property. For more information, refer to Texas Real Estate Consumer Notice Concerning Recognized Hazards or Deficiencies below.

THIS PROPERTY INSPECTION IS NOT A TECHNICALLY EXHAUSTIVE INSPECTION OF THE STRUCTURE, SYSTEMS OR COMPONENTS. THE INSPECTION MAY NOT REVEAL ALL DEFICIENCIES. A REAL ESTATE INSPECTION HELPS TO REDUCE SOME OF THE RISK INVOLVED IN PURCHASING A HOME, BUT IT CANNOT ELIMINATE THESE RISKS, NOR CAN THE INSPECTION ANTICIPATE FUTURE EVENTS OR CHANGES IN PERFORMANCE DUE TO CHANGES IN USE OR OCCUPANCY. It is recommended that you obtain as much information as is available about this property, including any seller's disclosures, previous inspection reports, engineering reports, building/remodeling permits, and reports performed for or by relocation companies, municipal inspection departments, lenders, insurers, and appraisers. You should also attempt to determine whether repairs, renovation, remodeling, additions, or other such activities have taken place at this property. It is not the inspector's responsibility to confirm that information obtained from these sources is complete or accurate or that this inspection is consistent with the opinions

expressed in previous or future reports.

ITEMS IDENTIFIED IN THE REPORT DO NOT OBLIGATE ANY PARTY TO MAKE REPAIRS OR TAKE OTHER ACTIONS, NOR IS THE PURCHASER REQUIRED TO REQUEST THAT THE SELLER TAKE ANY ACTION. *When a deficiency is reported, it is the client's responsibility to obtain further evaluations and/or cost estimates from qualified service professionals. Any such follow-up should take place prior to the expiration of any time limitations such as option periods. Evaluations by qualified tradesmen may lead to the discovery of additional deficiencies which may involve additional repair costs.* Failure to address deficiencies or comments noted in this report may lead to further damage of the structure or systems and add to the original repair costs. The inspector is not required to provide follow-up services to verify that proper repairs have been made.

Property conditions change with time and use. For example, mechanical devices can fail at any time, plumbing gaskets and seals may crack if the appliance or plumbing fixture is not used often, roof leaks can occur at any time regardless of the apparent condition of the roof, and the performance of the structure and the systems may change due to changes in use or occupancy, effects of weather, etc. These changes or repairs made to the structure after the inspection may render information contained herein obsolete or invalid. ***This report is provided for the specific benefit of the client named above and is based on observations at the time of the inspection. If you did not hire the inspector yourself, reliance on this report may provide incomplete or outdated information.*** Repairs, professional opinions or additional inspection reports may affect the meaning of the information in this report. It is recommended that you hire a licensed inspector to perform an inspection to meet your specific needs and to provide you with current information concerning this property.

TEXAS REAL ESTATE CONSUMER NOTICE CONCERNING HAZARDS OR DEFICIENCIES

Each year, Texans sustain property damage and are injured by accidents in the home. While some accidents may not be avoidable, many other accidents, injuries, and deaths may be avoided through the identification and repair of certain hazardous conditions. Examples of such hazards include:

- malfunctioning, improperly installed or missing ground fault circuit protection (GFCI) devices for electrical receptacles in garages, bathroom, kitchens, and exterior areas;
- malfunctioning arc fault protection (AFCI) devices;
- ordinary glass in locations where modern construction techniques call for safety glass;
- the lack of fire safety features, such as smoke alarms, fire-rated doors in certain locations, and functional emergency escape and rescue openings in bedrooms;
- malfunctioning carbon monoxide alarms;
- excessive spacing between balusters on stairways and porches;
- improperly installed appliances;
- improperly installed or defective safety devices
- lack of electrical bonding and grounding; and
- lack of bonding on gas piping, including corrugated stainless steel tubing (CSST).

To ensure that consumers are informed of hazards such as these, the Texas Real Estate Commission (TREC) has adopted Standards of Practice requiring licensed inspectors to report these conditions as "Deficient" when performing an inspection for a buyer or seller, if they can be reasonably determined.

These conditions may not have violated building codes or common practices at the time of the construction of the home, or they may have been "**grandfathered**" because they were present prior to the adoption of codes prohibiting such conditions. While the TREC Standards of Practice do not require inspectors to perform a code compliance inspection, TREC considers the potential for injury or property loss from the hazards addressed in the Standards of Practice to be significant enough to warrant this notice.

Contract forms developed by TREC for use by its real estate licensees also inform the buyer of the right to have the home inspected and can provide an option clause permitting the buyer to terminate the contract within a specified time. ***Neither the Standards of Practice nor the TREC contract forms requires a seller to remedy conditions revealed by an inspection. The decision to correct a hazard or any deficiency identified in an inspection report is left to the parties to the contract for the sale or purchase of the home.***

INFORMATION INCLUDED UNDER "ADDITIONAL INFORMATION PROVIDED BY INSPECTOR", OR PROVIDED AS AN ATTACHMENT WITH THE STANDARD FORM, IS NOT REQUIRED BY THE COMMISSION AND MAY CONTAIN CONTRACTUAL TERMS BETWEEN THE INSPECTOR AND YOU, AS THE CLIENT. THE COMMISSION DOES NOT REGULATE CONTRACTUAL TERMS BETWEEN PARTIES. IF YOU DO NOT UNDERSTAND THE EFFECT OF ANY CONTRACTUAL TERM CONTAINED IN THIS SECTION OR ANY ATTACHMENTS, CONSULT AN ATTORNEY.

This confidential report is prepared exclusively for Donald P Cunningham on 08/27/2021.

ADDITIONAL INFORMATION PROVIDED BY INSPECTOR

Inspection Time In: **9 am** Time Out: **1 pm** Property was: **Vacant**
Building Orientation (For Purpose Of This Report Front Faces): **East**
Weather Conditions During Inspection: **Sunny**
Outside temperature during inspection: **70 ° to 80 ° Degrees**
Parties present at inspection: **No other parties present during inspection.**

THIS REPORT IS PAID AND PREPARED FOR THE EXCLUSIVE USE BY Donald P Cunningham. THIS COPYRIGHTED REPORT IS NOT VALID WITHOUT THE SIGNED INSPECTION AGREEMENT.

THIS REPORT IS NOT TRANSFERABLE FROM CLIENT NAMED ABOVE.

SCOPE OF INSPECTION

These standards of practice define the minimum levels of inspection required for substantially completed residential improvements to real property up to four dwelling units. A real estate inspection is a non-technically exhaustive, limited visual survey and basic performance evaluation of the systems and components of a building using normal controls and does not require the use of specialized equipment or procedures. The purpose of the inspection is to provide the client with information regarding the general condition of the residence at the time of inspection. The inspector may provide a higher level of inspection performance than required by these standards of practice and may inspect components and systems in addition to those described by the standards of practice.

GENERAL LIMITATIONS

The inspector is not required to:

(A) inspect:

- (i) items other than those listed within these standards of practice;
- (ii) elevators;
- (iii) detached buildings, decks, docks, fences, or waterfront structures or equipment;
- (iv) anything buried, hidden, latent, or concealed;
- (v) sub-surface drainage systems;
- (vi) automated or programmable control systems, automatic shut-off, photoelectric sensors, timers, clocks, metering devices, signal lights, lightning arrestor system, remote controls, security or data distribution systems, solar panels, outdoor kitchens, gas grills (built-in or free standing), refrigerators (built-in or free standing), wine coolers, ice makers or smart home automation components; or refrigerators (built-in or free standing), wine coolers, ice makers or smart home automation components; or
- (vii) concrete flatwork such as; driveways, sidewalks, walkways, paving stones or patios;

(B) report:

- (i) past repairs that appear to be effective and workmanlike except as specifically required by these standards;
- (ii) cosmetic or aesthetic conditions; or
- (iii) wear and tear from ordinary use;

(C) determine:

- (i) insurability, warrantability, suitability, adequacy, compatibility, capacity, reliability, marketability, operating costs, recalls, counterfeit products, product lawsuits, life expectancy, age, energy efficiency, vapor barriers, thermostatic performance, compliance with any code, listing, testing or protocol authority, utility sources, or manufacturer or regulatory requirements except as specifically required by these standards;
- (ii) the presence or absence of pests, termites, or other wood-destroying insects or organisms;
- (iii) the presence, absence, or risk of asbestos, lead-based paint, **MOLD**, mildew, corrosive or contaminated drywall "Chinese Drywall" or any other environmental hazard, environmental pathogen, carcinogen, toxin, mycotoxin, pollutant, fungal presence or activity, or poison;
- (iv) types of wood or preservative treatment and fastener compatibility; or
- (v) the cause or source of a conditions;

(D) anticipate future events or conditions, including but not limited to:

- (i) decay, deterioration, or damage that may occur after the inspection;
- (ii) deficiencies from abuse, misuse or lack of use;
- (iii) changes in performance of any component or system due to changes in use or occupancy;
- (iv) the consequences of the inspection or its effects on current or future buyers and sellers;
- (v) common household accidents, personal injury, or death;
- (vi) the presence of water penetrations; or
- (vii) future performance of any item;

(E) operate shut-off, safety, stop, pressure or pressure-regulating valves or items requiring the use of codes, keys, combinations, or similar devices;

(F) designate conditions as safe;

(G) recommend or provide engineering, architectural, appraisal, mitigation, physical surveying, realty, or other specialist services;

(H) review historical records, installation instructions, repair plans, cost estimates, disclosure documents, or other reports;

(I) verify sizing, efficiency, or adequacy of the ground surface drainage system;

(J) verify sizing, efficiency, or adequacy of the gutter and downspout system;

(K) operate recirculation or sump pumps;

(L) remedy conditions preventing inspection of any item;

(M) apply open flame or light a pilot to operate any appliance;

(N) turn on decommissioned equipment, systems or utility services; or

(O) provide repair cost estimates, recommendations, or re-inspection services.

THE CLIENT, BY ACCEPTING THIS PROPERTY INSPECTION REPORT OR RELYING UPON IT IN ANY WAY, EXPRESSLY AGREES TO THE SCOPE OF INSPECTION, GENERAL LIMITATIONS AND INSPECTION AGREEMENT INCLUDED IN THIS INSPECTION REPORT.

This inspection report is made for the sole purpose of assisting the purchaser to determine his and/or her own opinion of feasibility of purchasing the inspected property and does not warrant or guarantee all defects to be found. If you have any questions or are unclear regarding our findings, please call our office prior to the expiration of any time limitations such as option periods.

This report contains technical information. If you were not present during this inspection, please call the office to arrange for a consultation with your inspector. If you choose not to consult with the inspector, this inspection company cannot be held liable for your understanding or misunderstanding of the reports content.

The contents of this report are for the sole use of the client named above and no other person or party may rely on this report for any reason or purpose whatsoever without the prior written consent of the inspector who authored the report. Any person or party who chooses to rely on this report for any reason or purpose whatsoever without the express written consent of the inspector does so at their own risk and by doing so without the prior written consent of the inspector waives any claim of error or deficiency in this report.

This report is not intended to be used for determining insurability or warrantability of the structure and may not conform to the Texas Department of Insurance guidelines for property insurability. *This report is not to be used by or for any property and/or home warranty company.*

The digital pictures within this report are a representative sample of inaccessible areas, deficiencies or damages in place and should not be considered to show all of the inaccessible areas, deficiencies or damages observed. There will be inaccessible areas, deficiencies or damages not represented with digital imaging.

I=Inspected

NI=Not Inspected

NP=Not Present

D=Deficient

I NI NP D

I. STRUCTURAL SYSTEMS

A. Foundations

Type of Foundation(s): Slab on Ground

Comments:

Foundation Is Performing Adequately

In my opinion, the foundation appears to be providing adequate support for the structure at the time of this inspection. I did not observe any apparent evidence that would indicate the presence of adverse performance or significant deficiencies in the foundation. The interior and exterior stress indicators showed little affects of adverse performance and I perceived the foundation to contain no significant unlevelness after walking the 1st level floors.

Notice: This inspection is one of first impression and the inspector was not provided with any historical information pertaining to the structural integrity of the inspected real property. This is a limited cursory and visual survey of the accessible general conditions and circumstances present at the time of this inspection. Opinions are based on general observations made without the use of specialized tools or procedures. Therefore, the opinions expressed are one of apparent conditions and not of absolute fact and are only good for the date and time of this inspection. The inspection of the foundation may show it to be providing adequate support for the structure or having movement typical to this region, at the time of the inspection. This does not guarantee the future life or failure of the foundation. ***The Inspector is not a structural engineer. This inspection is not an engineering report or evaluation and should not be considered one, either expressed or implied.*** If any cause of concern is noted on this report, or if you want further evaluation, you should consider an evaluation by an engineer of your choice.

I=Inspected

NI=Not Inspected

NP=Not Present

D=Deficient

I	NI	NP	D
---	----	----	---

-
-
-
-

B. Grading and Drainage

Comments:

Grading & Drainage

Notice: There is an underground and/or surface drainage system in place. The inspector cannot and will not be able to verify the operation, sizing, efficiency or adequacy of the underground and/or surface drainage system. If there are any questions or concerns with this system or the effectiveness of the system, you should consult with the current owner or the appropriate specialist related to this type of system.



Gutter & Downspout System

All components were found to be performing and in satisfactory condition on the day of the inspection.

I=Inspected

NI=Not Inspected

NP=Not Present

D=Deficient

I	NI	NP	D
---	----	----	---

-
-
-
-

C. Roof Covering Materials

Type(s) of Roof Covering: Composition and Metal

Viewed From: Drone

Comments:

General Photos of Roof



I=Inspected

NI=Not Inspected

NP=Not Present

D=Deficient

I	NI	NP	D
---	----	----	---



I=Inspected

NI=Not Inspected

NP=Not Present

D=Deficient

I	NI	NP	D
---	----	----	---



I=Inspected

NI=Not Inspected

NP=Not Present

D=Deficient

I	NI	NP	D
---	----	----	---



I=Inspected

NI=Not Inspected

NP=Not Present

D=Deficient

I	NI	NP	D
---	----	----	---

Roof Covering

- **Note:** Roof fasteners (nails and/or staples) were observed to be exposed and should be properly sealed at the ridge caps and flashing areas.



Flashing Details

- The storm collar at the gas equipment roof level vent pipe is not properly installed and/or positioned over the roof jack. The storm collar needs to be properly positioned over the roof jack and sealed to help prevent water intrusion within the roof structure.
- The storm collar(s) at the roof level gas equipment vent pipe(s) need to be properly sealed to help prevent water intrusion into the structure.

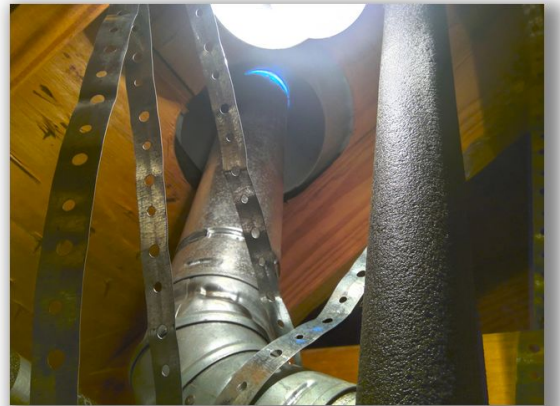

I=Inspected

NI=Not Inspected

NP=Not Present

D=Deficient

I	NI	NP	D
---	----	----	---

Skylight(s)

- Some of the metal flashing details were observed to be rusted and should be corrected as necessary.

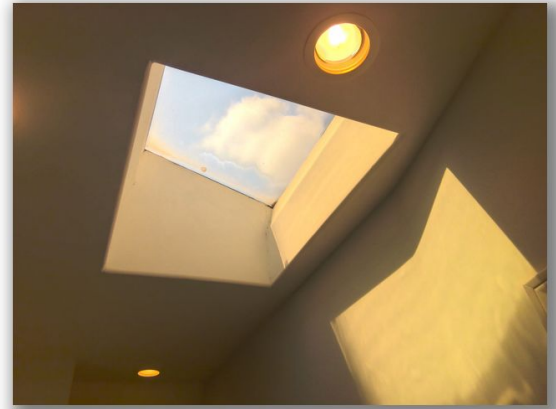

Notice: Life expectancy of the roofing material is not covered by this property inspection report. If any concerns exist about the roof covering life expectancy or potential for future problems, a roofing specialist should be consulted. The Inspector cannot offer an opinion or warranty as to whether the roof has leaked in the past, leaks now, or may be subject to future leaks, either expressed or implied.

The inspection of this roof may show it to be functioning as intended or in need of minor repairs. This inspection does not determine the insurability of the roof. You are strongly encouraged to have your Insurance Company physically inspect the roof, prior to the expiration of any time limitations such as option or warranty periods, to fully evaluate the insurability of the roof.

I=Inspected

NI=Not Inspected

NP=Not Present

D=Deficient

I	NI	NP	D
---	----	----	---

-
-
-
-

D. Roof Structures and Attics

Viewed From: From Interior of Attic

Approximate Average Depth of Insulation: 10" to 13"

(**Note:** Generally recommended depth of attic floor insulation is approximately 10+ inches to achieve a R30 rating.)

Insulation Type: Loose Filled

Description of Roof Structure: Rafter Assembly

Attic Accessibility: Partial

Comments:

General Photos of Rafter Assembly

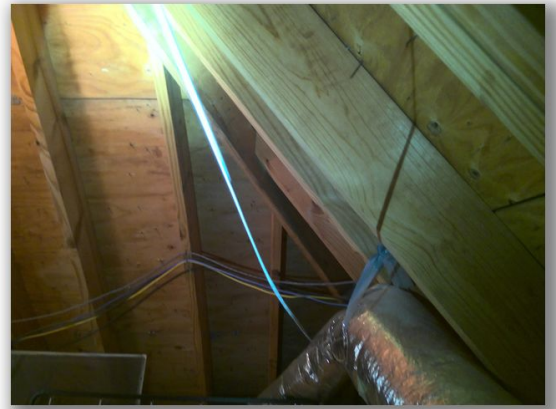
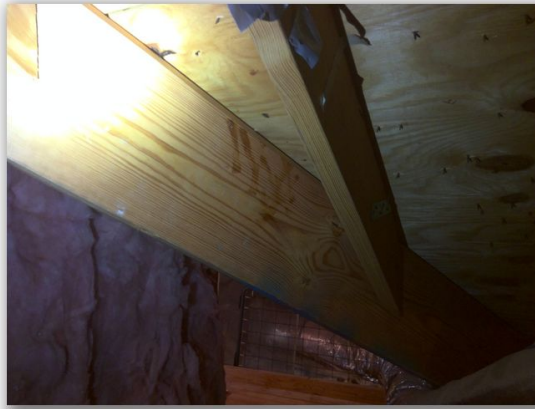
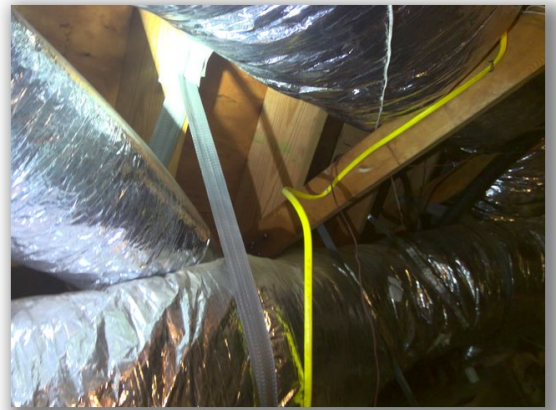

I=Inspected

NI=Not Inspected

NP=Not Present

D=Deficient

I	NI	NP	D
---	----	----	---

Roof Structure

All components were found to be performing and in satisfactory condition on the day of the inspection.

Attic Ventilation

All components were found to be performing and in satisfactory condition on the day of the inspection.

Attic Insulation

All components were found to be performing and in satisfactory condition on the day of the inspection.



I=Inspected

NI=Not Inspected

NP=Not Present

D=Deficient

I	NI	NP	D
---	----	----	---

E. Walls (Interior and Exterior)

Comments:

Description of Exterior Cladding: Hard Coat Stucco

Interior Walls & Surfaces

All components were found to be performing and in satisfactory condition on the day of the inspection.

I=Inspected

NI=Not Inspected

NP=Not Present

D=Deficient

I	NI	NP	D
---	----	----	---

Exterior Walls & Surfaces

- **Note:** The heavy foliage growing on, over or around the exterior walls of the structure should be trimmed back at least 18-inches. The heavy foliage will limit the Inspectors visual observation of the exterior surfaces.



I=Inspected

NI=Not Inspected

NP=Not Present

D=Deficient

I	NI	NP	D
---	----	----	---

Stucco (Hard Coat or EIFS) Observation and Opinions

There is a stucco type product installed as the exterior veneer / cladding for this structure. Due to the known general misapplication of residential stucco products, associated deficiencies and water intrusion problems; full evaluation of this product requires a specialty inspection from a Properly Certified Third Party Stucco Inspector. Our company does not provide this service. You may consider contacting a Properly Certified Third Party Stucco Inspector to schedule a specialty inspection of the stucco product.

At this time a general limited visually based survey of the accessible exterior stucco veneer / cladding will be performed without the use of any specialized tools or procedures. The Inspectors findings will be listed below but all possible deficiencies will not be limited to the following:

- Failing or missing sealant was observed at and around the stucco type veneer/cladding and the wall opening interfaces (windows, doors, electrical outlets, plumbing outlets, etc.) This condition should be improved to help prevent water intrusion at these locations.

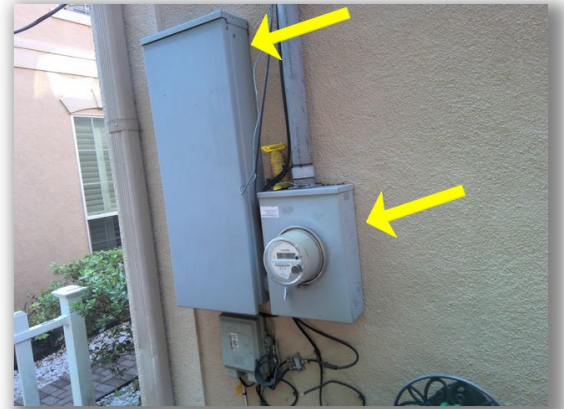

I=Inspected

NI=Not Inspected

NP=Not Present

D=Deficient

I	NI	NP	D
---	----	----	---

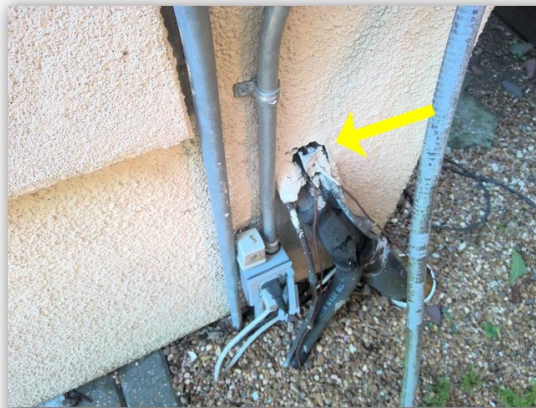

I=Inspected

NI=Not Inspected

NP=Not Present

D=Deficient

I	NI	NP	D
---	----	----	---



I=Inspected

NI=Not Inspected

NP=Not Present

D=Deficient

I	NI	NP	D
---	----	----	---

- The exterior stucco type veneer/cladding has inadequate clearance from the concrete flatwork. Most manufacturers require a minimum of 2-inches of clearance from all concrete flatwork.



I=Inspected

NI=Not Inspected

NP=Not Present

D=Deficient

I	NI	NP	D
---	----	----	---

- The exterior stucco type veneer/cladding has inadequate clearance from the finished grade (ground). Most manufacturers require a minimum of 4- to 6-inches of clearance from the finished grade (ground).



I=Inspected

NI=Not Inspected

NP=Not Present

D=Deficient

I	NI	NP	D
---	----	----	---

- Cracking of the stucco type veneer/cladding was observed on the west side of the structure. This condition should be further evaluated and corrected as necessary.



- Some discoloration and/or staining of the stucco type veneer/cladding was observed on the west side of the structure.

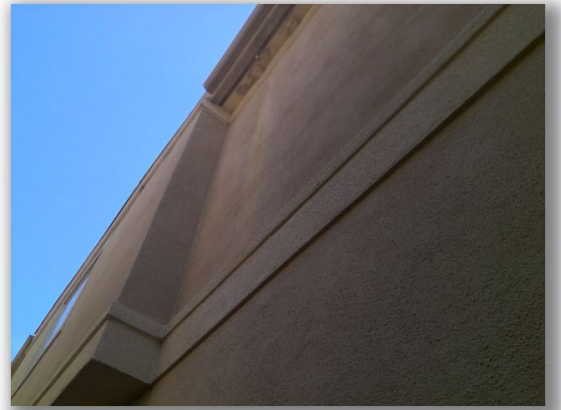

I=Inspected

NI=Not Inspected

NP=Not Present

D=Deficient

I	NI	NP	D
---	----	----	---

F. Ceilings and Floors

Comments:

Ceilings

- Elevated moisture levels were detected in the ceiling finished surfaces in the kitchen. The cause and remedy should be further evaluated and corrected as necessary.



I=Inspected

NI=Not Inspected

NP=Not Present

D=Deficient

I	NI	NP	D
---	----	----	---

- Elevated moisture levels were detected in the ceiling finished surfaces in the dining room. The cause and remedy should be further evaluated and corrected as necessary.
- Water stains were observed on the ceiling finish in the dining room. The cause and remedy should be further evaluated and corrected as necessary.

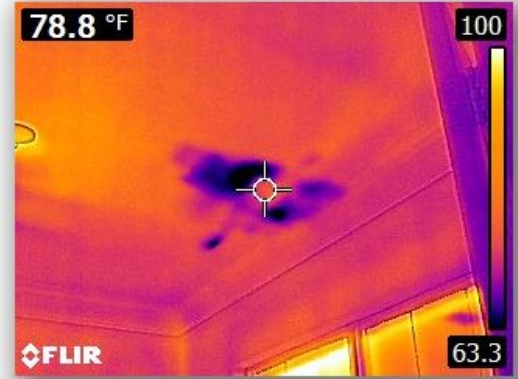

I=Inspected

NI=Not Inspected

NP=Not Present

D=Deficient

I	NI	NP	D
---	----	----	---

- Elevated moisture levels were detected in the ceiling finished surfaces in the master bathroom. The cause and remedy should be further evaluated and corrected as necessary.



I=Inspected

NI=Not Inspected

NP=Not Present

D=Deficient

I	NI	NP	D
---	----	----	---

Floors

- **Note:** Some cracking of the garage concrete floor finish was observed.



- The floor tile(s) were observed to be cracked and/or damaged in master bathroom.



I=Inspected

NI=Not Inspected

NP=Not Present

D=Deficient

I	NI	NP	D
---	----	----	---

G. Doors (Interior and Exterior)

Comments:

Interior Doors

- The door is sticking to the gameroom bathroom
- The door is not latching properly to the master bedroom closet.

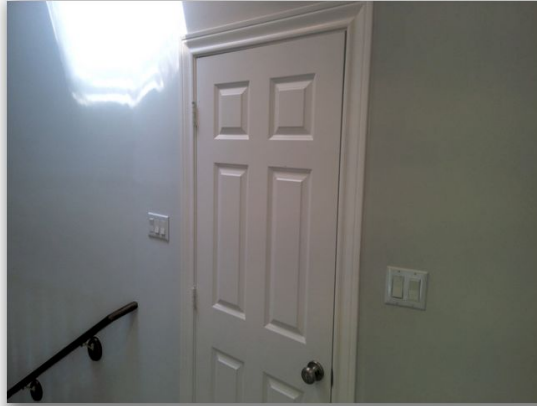

Exterior Doors

- Weather-stripping improvements are recommended for the front entry exterior door(s).

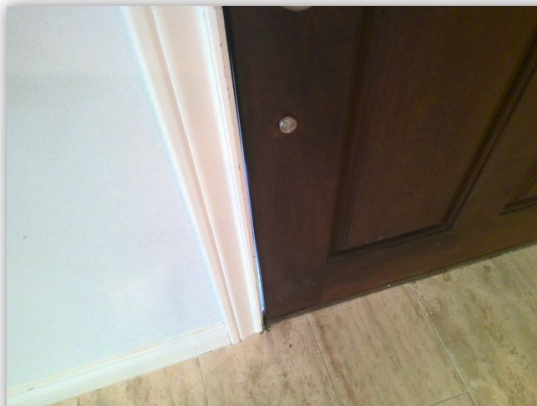

I=Inspected

NI=Not Inspected

NP=Not Present

D=Deficient

I	NI	NP	D
---	----	----	---

- The door frame has some damage to the balcony.
- The door is loose at the hinges to the balcony.
- The door is sticking to the balcony.



Overhead Garage Door

All components were found to be performing and in satisfactory condition on the day of the inspection.

Garage Entry Door

- The garage entry door is not equipped with a self-closing device.

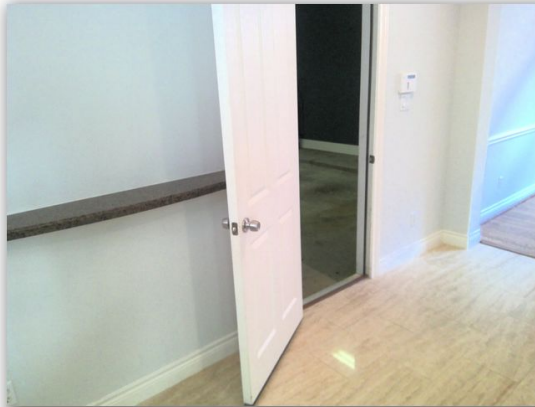

I=Inspected

NI=Not Inspected

NP=Not Present

D=Deficient

I	NI	NP	D
---	----	----	---

H. Windows

Comments:

Window Screens

- One or more of the window screens were observed to be damaged.



Windows

- Missing exterior vinyl glazing bead observed on one or more windows.



I=Inspected

NI=Not Inspected

NP=Not Present

D=Deficient

I	NI	NP	D
---	----	----	---

- One or more of the thermal pane windows were observed to have lost their seals. This has resulted in condensation or a fog like film to develop between the panes of glass. The thermal pane windows no longer function as designed when they loose their seal and replacement may be necessary. The windows that have noticeably lost their seals are listed but may not be limited to the following:
gameroom.

(Total 1)

Special Notice: Signs of lost seals in the thermal pane windows may appear and disappear as temperature and humidity changes. Some windows with lost seals may not be evident at the time of this inspection. Windows are checked in a non-exhaustive manner for obvious fogging. When lost thermal pane window seals were noted, we recommend all windows be rechecked by a window specialist for further evaluation prior to the expiration of any time limitations such as option or warranty periods.



I=Inspected

NI=Not Inspected

NP=Not Present

D=Deficient

I	NI	NP	D
---	----	----	---

Safety Glass

(Under current building standards the following are considered hazardous locations that require safety glass.)

- Glass in individual fixed or operable panels within 18-inches of the floor.



I=Inspected

NI=Not Inspected

NP=Not Present

D=Deficient

I	NI	NP	D
---	----	----	---

-

I. Stairways (Interior and Exterior)

Comments:

All components were found to be performing and in satisfactory condition on the day of the inspection.

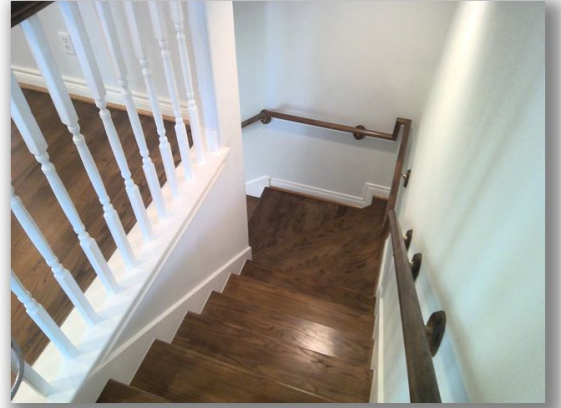
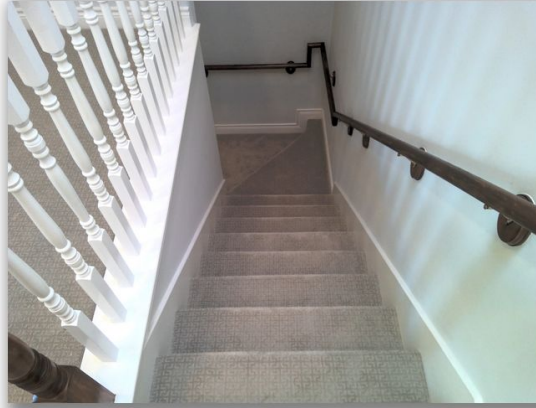

-

J. Fireplaces and Chimneys

Comments:

All components were found to be performing and in satisfactory condition on the day of the inspection.



I=Inspected

NI=Not Inspected

NP=Not Present

D=Deficient

I	NI	NP	D
---	----	----	---

K. Porches, Balconies, Decks, and Carports

Comments:

Porches

All components were found to be performing and in satisfactory condition on the day of the inspection.

Driveway

All components were found to be performing and in satisfactory condition on the day of the inspection.

I=Inspected

NI=Not Inspected

NP=Not Present

D=Deficient

I NI NP D

II. ELECTRICAL SYSTEMS

A. Service Entrance and Panels

Comments:

Panel Box

Box Rating and/or Main Disconnect Rating: 200 amps

Box Location: North Exterior Wall

Cabinet Manufacturer: Cutler-Hammer

Branch Circuit Wire Type: Copper

- One or more of the cabinet cover plate screws are missing and need to be replaced.

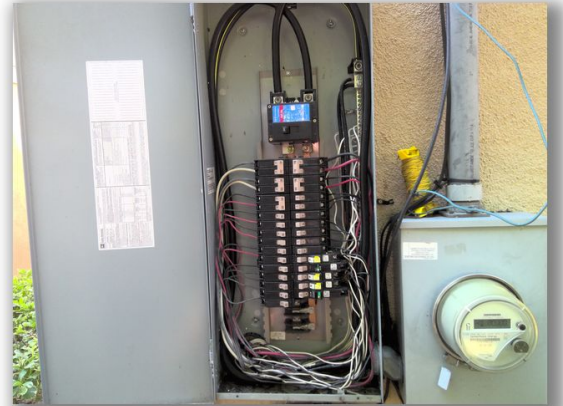

- There was no anti-oxidant gel observed on the exposed aluminum conductor terminations.
- One or more of the neutral wires in the electrical cabinet were observed to be double lugged (i.e. two wires under one screw). The neutral wires need to be separated to prevent damage to the panel box and electrical system

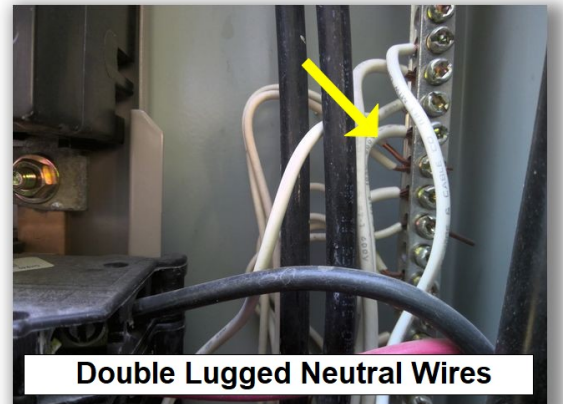
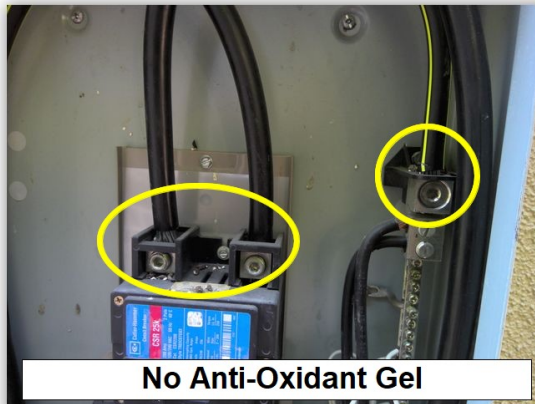

I=Inspected

NI=Not Inspected

NP=Not Present

D=Deficient

I	NI	NP	D
---	----	----	---

- White hot wires should be labeled with black tape.

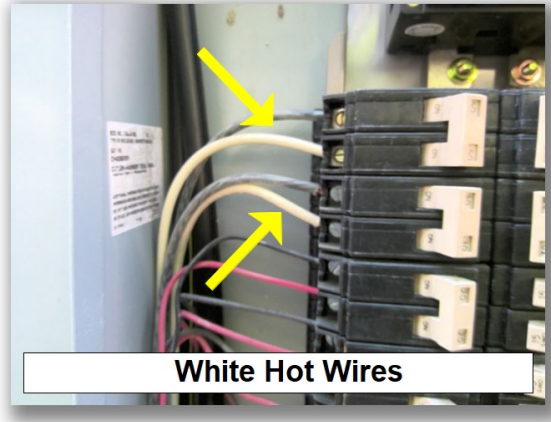

- There was no GFCI protection device observed to be installed for the Oven (unless hardwired) AC and Dryer circuits. This does not meet current building standards according to the NEC (National Electrical Code)

Arc-Fault Circuit Interrupter Protection (AFCI)

- Not all of the required dwelling unit devices, receptacle and lighting outlets (switches, receptacles and fixtures) are connected to an arc-fault circuit-interrupter (AFCI) circuit device. Under the current National Electrical Code, all of the dwelling units devices, receptacle and lighting outlets (switches, receptacles and fixtures) should be connected to an arc-fault circuit interrupter (AFCI) device.

I=Inspected

NI=Not Inspected

NP=Not Present

D=Deficient

I	NI	NP	D
---	----	----	---

Distribution Wiring

- Open electrical junction box(es) were observed in the attic area. All open junction box(es) in the attic should be properly enclosed.



I=Inspected

NI=Not Inspected

NP=Not Present

D=Deficient

I	NI	NP	D
---	----	----	---

Grounding / Bonding

- Water pipe bonding was visible at hose bibb area.

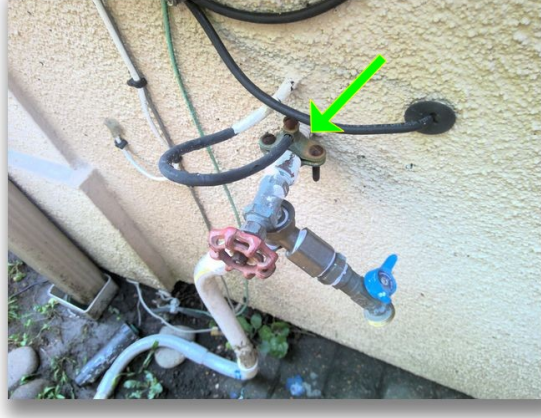

General Photo(s) of Grounding Electrode(s)

- Improper clamp was observed for exterior grounding electrode. A properly installed acorn clamp is required.
- **Note:** Inspector was unable to locate a supplemental source of grounding.

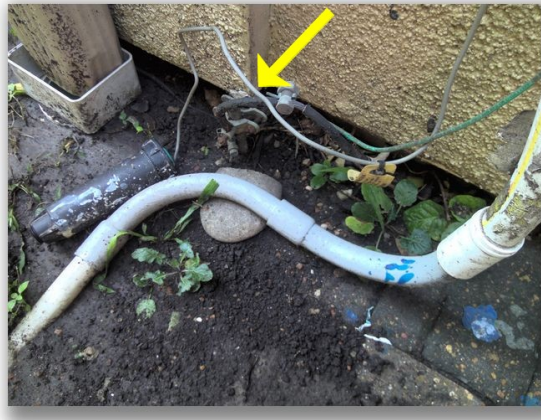

I=Inspected

NI=Not Inspected

NP=Not Present

D=Deficient

I	NI	NP	D
---	----	----	---

B. Branch Circuits, Connected Devices, and Fixtures

Type of Wiring: Copper

Comments:

Receptacle Outlets

- Not all of the exterior receptacles appear to be connected to a ground fault circuit interrupter (GFCI) device. Under current electrical standards, all of the exterior receptacles should have GFCI protection.

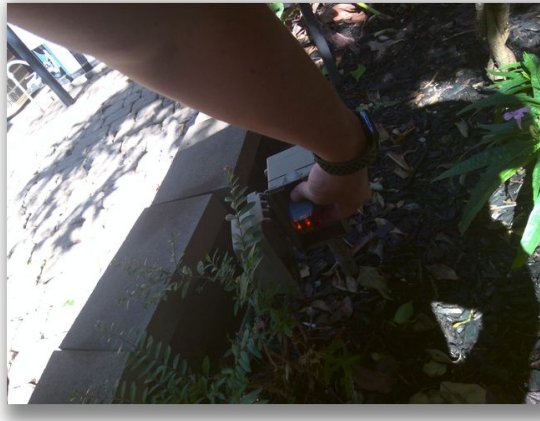

- Not all of the garage receptacles appear to be connected to a ground fault circuit interrupter (GFCI) device. Under current electrical standards, all of the garage receptacles should have GFCI protection. There New National Electrical (NEC) Code no longer has an exception for “non-appliance dedicated”.
- One or more of the receptacles is missing its cover plate in the garage.

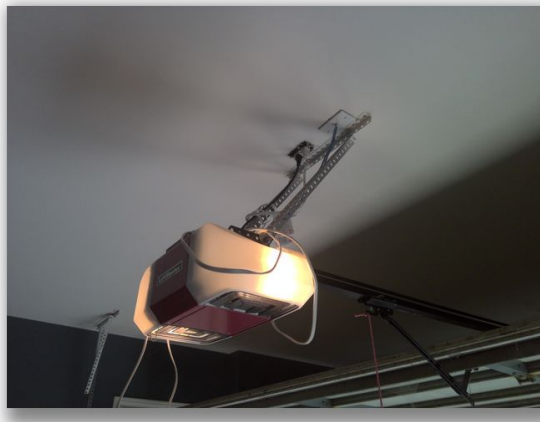

I=Inspected

NI=Not Inspected

NP=Not Present

D=Deficient

I	NI	NP	D
---	----	----	---

- One of the ground fault circuit interrupter (GFCI) devices does not appear to be functioning properly at the time of this inspection. The device in question is located in the half bathroom.



- The receptacle(s) in the kitchen cabinet under the kitchen sink do not appear to be connected to a ground fault circuit interrupter (GFCI) device. Under current electrical standards, all receptacles within 6-feet of the sink, including the receptacles in cabinetry, should have GFCI protection.
- The laundry room area receptacles do not appear to be connected to a ground fault circuit interrupter (GFCI) device. Under current electrical standards, all of the receptacles in the laundry room area should have GFCI protection.

I=Inspected

NI=Not Inspected

NP=Not Present

D=Deficient

I	NI	NP	D
---	----	----	---

- One or more of the receptacles were observed to have an open ground connection in the living room.



Switches

- **Note:** I was unable to determine the operation end of one or more of the switches.

I=Inspected

NI=Not Inspected

NP=Not Present

D=Deficient

I	NI	NP	D
---	----	----	---

Fixtures

- One or more of the light fixtures appear to be inoperative in various locations throughout the house. This may be due to a bad bulb or some other unknown condition. This condition should be further evaluated and corrected as necessary.



I=Inspected

NI=Not Inspected

NP=Not Present

D=Deficient

I NI NP D

Smoke Alarms

Note: It is recommended to replace the batteries in all of the smoke detectors once a year for reasons of safety.

- One or more of the smoke alarms did not respond properly when tested in the gameroom, master bedroom hallway.

SECTION R314 SMOKE ALARMS

R314.3 Location. Smoke alarms shall be installed in the following locations:

1. In each sleeping room.
2. Outside each separate sleeping area in the immediate vicinity of the bedrooms.
3. On each additional story of the dwelling, including basements and habitable attics but not including crawl spaces and uninhabitable attics. In dwellings or dwelling units with split levels and without an intervening door between the adjacent levels, a smoke alarm installed on the upper level shall suffice for the adjacent lower level provided that the lower level is less than one full story below the upper level.

Carbon Monoxide Alarms

All components were found to be performing and in satisfactory condition on the day of the inspection.

Doorbell / Chime

- The doorbell and/or associated components appear to be inoperative.



I=Inspected

NI=Not Inspected

NP=Not Present

D=Deficient

I NI NP D

III. HEATING, VENTILATION AND AIR CONDITIONING SYSTEMS

A. Heating Equipment

Type of Systems:

Energy Sources:

Comments:

Upstairs Central Heating System – Energy Source: Gas

Brand Name: Lennox

This component appears to be performing adequately at the time of this inspection. It is achieving an operation, function, or configuration consistent with accepted industry practices for its age.



- The furnace flue should not be in contact with ductwork.

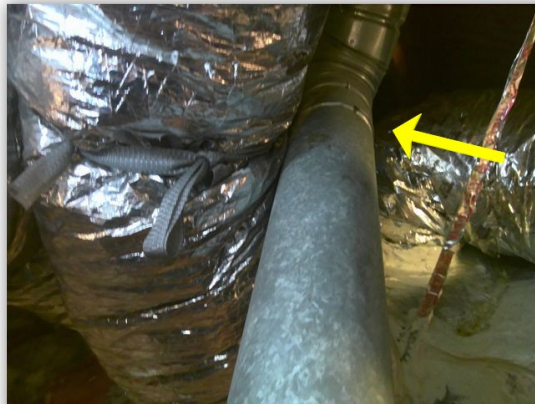

I=Inspected

NI=Not Inspected

NP=Not Present

D=Deficient

I	NI	NP	D
---	----	----	---

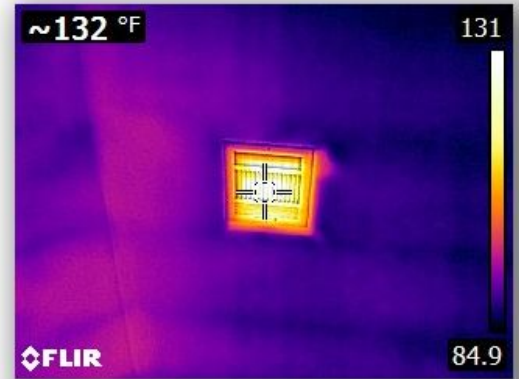
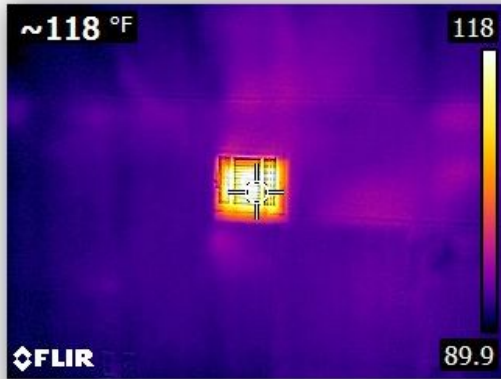

I=Inspected

NI=Not Inspected

NP=Not Present

D=Deficient

I NI NP D

- The heater gas supply line is not equipped with a sediment trap just before the gas appliance connector. This condition does not meet current installation requirements and should be corrected.

Samples of correct sediment trap installation.

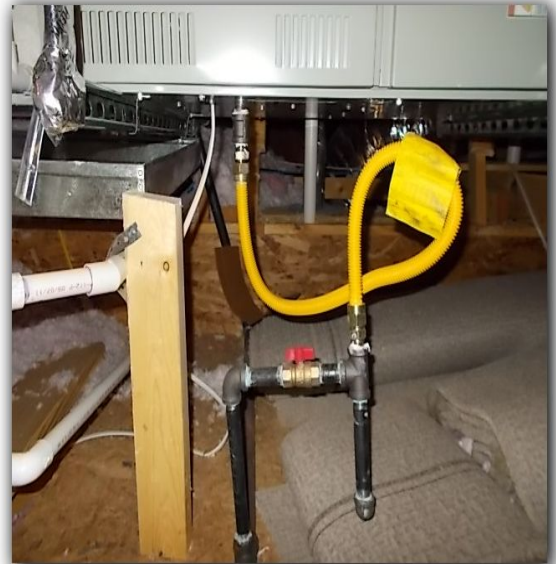
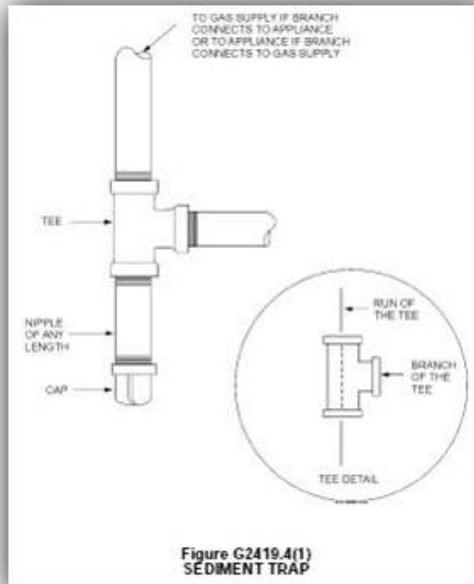

I=Inspected

NI=Not Inspected

NP=Not Present

D=Deficient

I	NI	NP	D
---	----	----	---

Downstairs Central Heating System – Energy Source: Gas
Brand Name: Lennox

This component appears to be performing adequately at the time of this inspection. It is achieving an operation, function, or configuration consistent with accepted industry practices for its age.

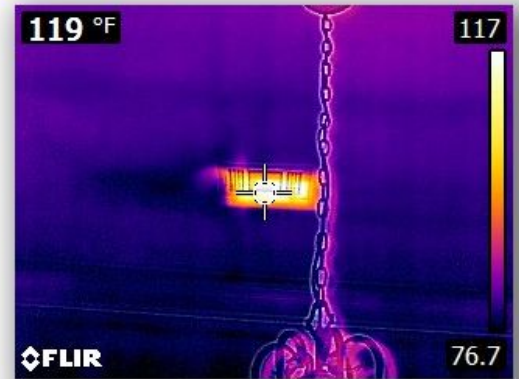
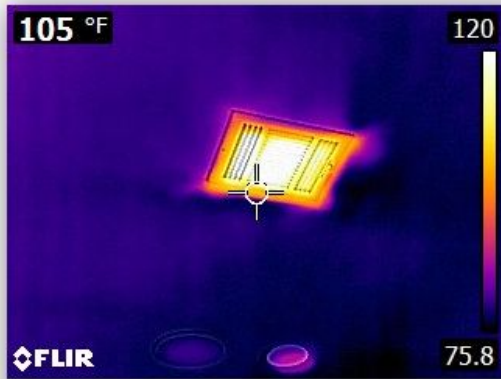

I=Inspected

NI=Not Inspected

NP=Not Present

D=Deficient

I NI NP D

- The heater gas supply line is not equipped with a sediment trap just before the gas appliance connector. This condition does not meet current installation requirements and should be corrected.

Samples of correct sediment trap installation.

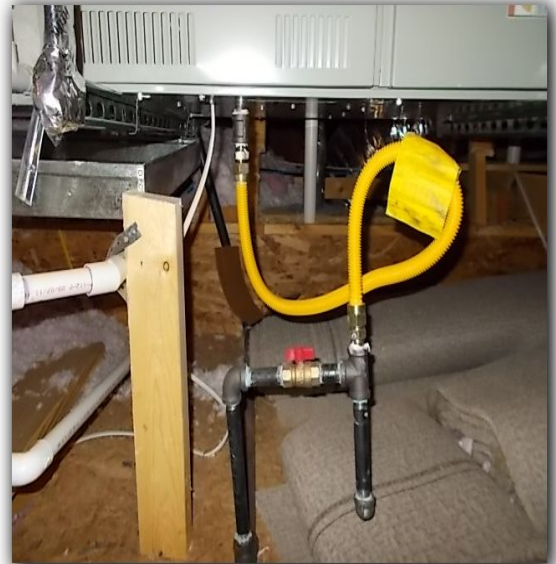
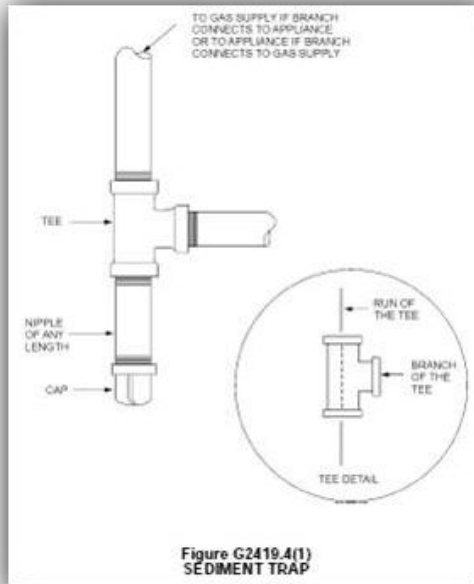

I=Inspected

NI=Not Inspected

NP=Not Present

D=Deficient

I NI NP D

B. Cooling Equipment

Type of Systems:

Comments:

Upstairs Central Cooling System

Today's Temperature Differential (Delta-T): 7

Approximate System Age: **2009**

Approximate System SEER: **Unable To Determine**

Approximate System Size: **2.5 ton**

Location: **Interior Ceiling Mounted**

Brand Name: **Unable To Determine**

The HVAC system and equipment needs to be checked and serviced by a Qualified / Licensed HVAC Technician. The observations made to support the rendering of this opinion are listed but may not be limited to the following:

- The temperature drop measured across the evaporative coils of the air conditioning system is lower than considered typical. The unit is not cooling properly and servicing is needed.

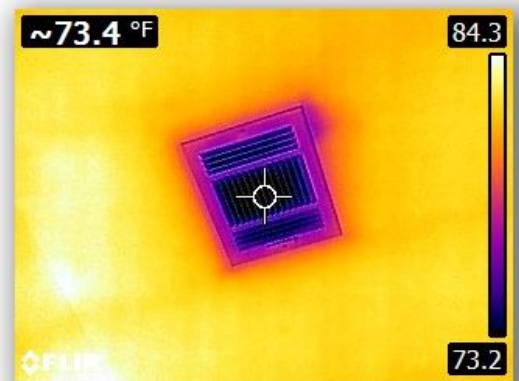

I=Inspected

NI=Not Inspected

NP=Not Present

D=Deficient

I	NI	NP	D
---	----	----	---

Additional Notice from the Inspector: The cooling equipment in place uses R-22 refrigerant. R-22 refrigerant is currently being phased out and is becoming progressively more expensive to obtain. You should be aware that R-22 components and their future life expectancy cannot be determined. You can continue to use and service these components until replacement is necessary. If you are being provided or purchasing a Home Warranty Policy, you should closely review the HVAC section of the policy related to R-22 refrigerant and component coverage.

- Damaged, deteriorated and/or missing insulation on the refrigerant lines should be repaired or replaced at the outside condenser.

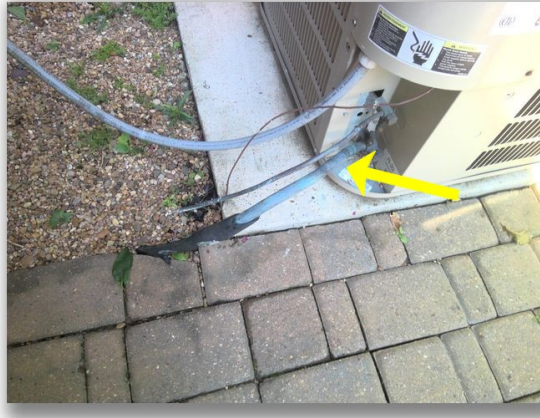

- The service disconnect interior cover plate (dead front) is missing. This should be corrected for reasons of safety.



I=Inspected

NI=Not Inspected

NP=Not Present

D=Deficient

I NI NP D

- The manufacturers listing plate on the outside condenser/coil list that the maximum over current device (breaker) to be used should not exceed 20-amp. There is a 50-amp breaker in place at this time. This breaker in place does not meet the manufacturers listing plate requirements.

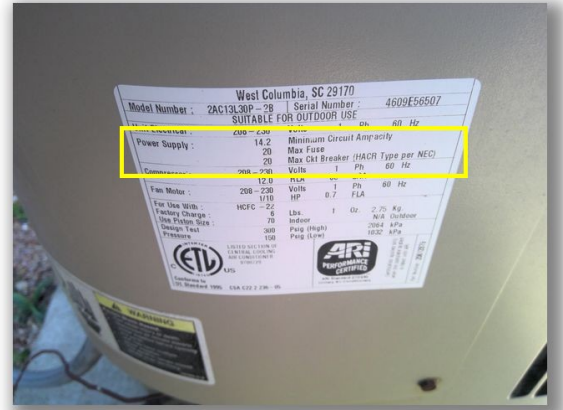
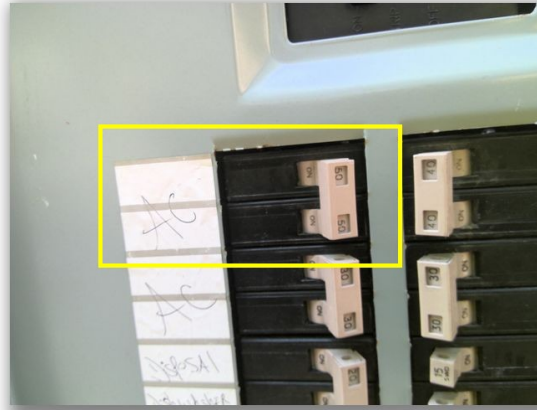

I=Inspected

NI=Not Inspected

NP=Not Present

D=Deficient

I NI NP D

Central Cooling System

Today's Temperature Differential (Delta-T): 17

Approximate System Age: **2016**

Approximate System SEER: **Unable To Determine**

Approximate System Size: **3 ton**

Location: **Interior Ceiling Mounted**

Brand Name: American Standard

This component appears to be performing adequately at the time of this inspection. It is achieving an operation, function, or configuration consistent with accepted industry practices for its age.

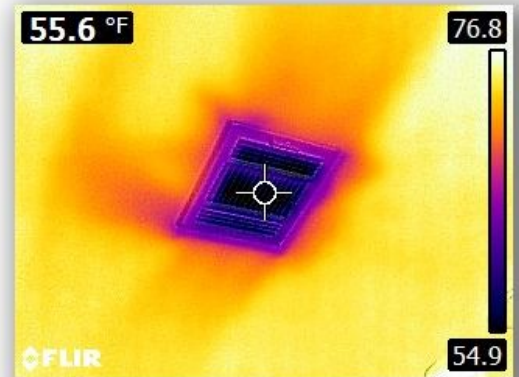
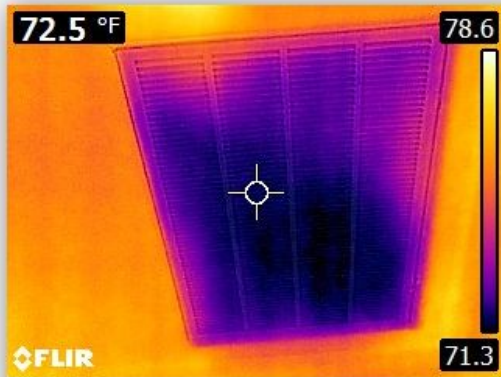
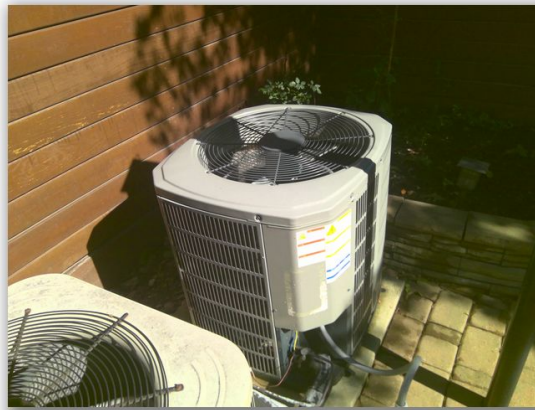

I=Inspected

NI=Not Inspected

NP=Not Present

D=Deficient

I NI NP D

Notice: Temperature differential readings are an accepted industry standard of practice for testing the proper operation of the cooling system. Our company policy normal acceptable range is considered approximately **between 15 to 20 degrees °F** total difference (Delta-T) measured between the return air and supply air within close proximity of the related coils of the system being evaluated. Conditions such as but not limited to; excessive humidity, high or low outdoor temperatures or restricted airflow may indicate abnormal operation even through the equipment is functioning basically as designed and occasionally may indicate normal operation in spite of an equipment malfunction. *The inspector will not be able to anticipate future events, conditions or changes in performance of any component or system due to changes in use or occupancy. The inspector makes no guarantee or warranty, express or implied, as to future performance of any item, system or component.*

I=Inspected

NI=Not Inspected

NP=Not Present

D=Deficient

I	NI	NP	D
---	----	----	---

C. Duct Systems, Chases, and Vents

Comments:

General Photo(s) of duct work

- Ducts that are touching should be separated by insulation to help prevent condensation.



I=Inspected

NI=Not Inspected

NP=Not Present

D=Deficient

I	NI	NP	D
---	----	----	---



I=Inspected

NI=Not Inspected

NP=Not Present

D=Deficient

I	NI	NP	D
---	----	----	---

- The air register has poor air flow in the upstairs hall bathroom. *****Temperatures taken with AC running*** SEE COOLING SECTION**

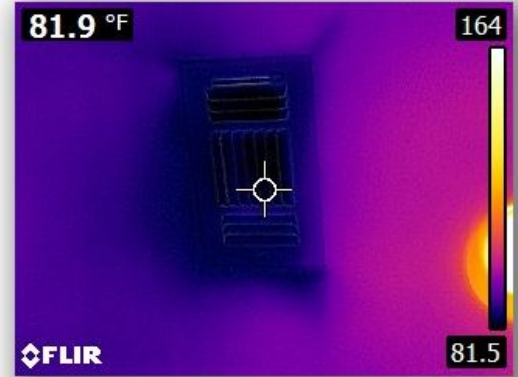

I=Inspected

NI=Not Inspected

NP=Not Present

D=Deficient

I	NI	NP	D
---	----	----	---

IV. PLUMBING SYSTEM

A. Plumbing Supply, Distribution Systems and Fixtures

Location of water meter: Within 5-feet of Front Curb

Location of main water supply valve: Back Exterior Wall

Static water pressure reading: 50 to 60 psi

Comments:



Exterior Faucets/Fixtures

- One or more of the exterior water hose bibbs (faucet) do not have a back-flow or anti-siphon device (Vacuum Breakers) in place. **Note:** *This is not uncommon to observe with a home of this age.*

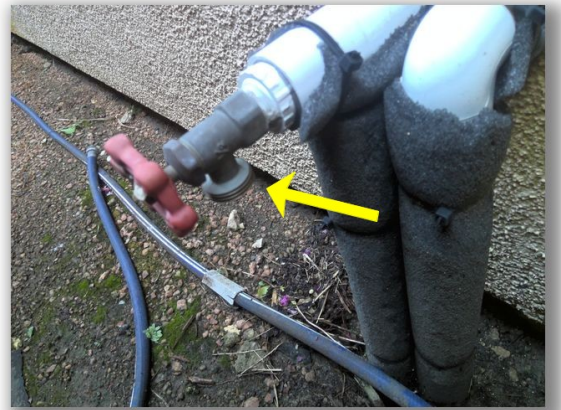
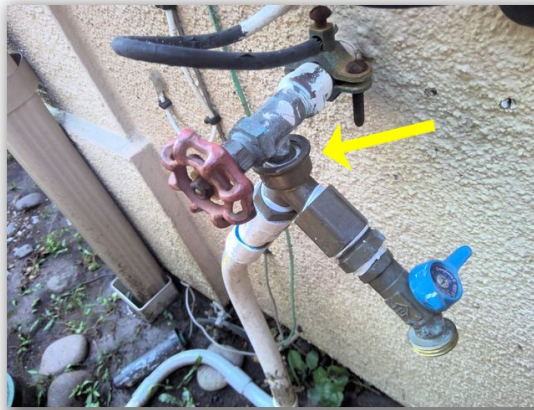

I=Inspected

NI=Not Inspected

NP=Not Present

D=Deficient

I	NI	NP	D
---	----	----	---

- Water was observed to be leaking back through the vacuum breaker on the east side of the structure. The vacuum breaker is not working as designed.
- The exterior water hose bibb (faucet) handle is damaged and/or missing on the east side of the structure.



Laundry Connections

All components were found to be performing and in satisfactory condition on the day of the inspection.



Kitchen Sink

All components were found to be performing and in satisfactory condition on the day of the inspection.

I=Inspected

NI=Not Inspected

NP=Not Present

D=Deficient

I	NI	NP	D
---	----	----	---

Gameroom Bathroom

Lavatory / Sink

All components were found to be performing and in satisfactory condition on the day of the inspection.

Bathtub

- Cracked, deteriorated and/or missing bathtub enclosure grout and/or caulking should be repaired or replaced as necessary.
- The tub spout is not sealed at the wall. This condition has the potential to allow water to leak back into the wall cavity.
- The faucet assembly is not sealed at the wall. This condition has the potential to allow water to leak back into the wall cavity.



Shower

All components were found to be performing and in satisfactory condition on the day of the inspection.

Commode / Toilet

All components were found to be performing and in satisfactory condition on the day of the inspection.

I=Inspected

NI=Not Inspected

NP=Not Present

D=Deficient

I	NI	NP	D
---	----	----	---

Master Bathroom

Left Lavatory / Sink

All components were found to be performing and in satisfactory condition on the day of the inspection.

Right Lavatory / Sink

All components were found to be performing and in satisfactory condition on the day of the inspection.

Bathtub

All components were found to be performing and in satisfactory condition on the day of the inspection.

Shower

- The faucet assembly is not sealed at the wall. This condition has the potential to allow water to leak back into the wall cavity.
- Cracked, deteriorated and/or missing shower stall grout and/or caulking should be repaired or replaced as necessary.



Commode / Toilet

All components were found to be performing and in satisfactory condition on the day of the inspection.

I=Inspected

NI=Not Inspected

NP=Not Present

D=Deficient

I NI NP D

Gameroom Bathroom

Left Lavatory / Sink

All components were found to be performing and in satisfactory condition on the day of the inspection.

Right Lavatory / Sink

All components were found to be performing and in satisfactory condition on the day of the inspection.

Bathtub

- The tub spout is not sealed at the wall. This condition has the potential to allow water to leak back into the wall cavity.
- The faucet assembly is not sealed at the wall. This condition has the potential to allow water to leak back into the wall cavity.



Shower

All components were found to be performing and in satisfactory condition on the day of the inspection.

Commode / Toilet

All components were found to be performing and in satisfactory condition on the day of the inspection.

Half Bath

Lavatory / Sink

All components were found to be performing and in satisfactory condition on the day of the inspection.

Commode / Toilet

All components were found to be performing and in satisfactory condition on the day of the inspection.

Notice: The Inspector has attempted to discover and report conditions requiring further evaluation or repair. However; determining the condition of any component that is not visible and/or accessible, such as plumbing components that are buried, beneath the foundation, located within construction voids or otherwise concealed, and reporting any deficiency that does not appear or become evident during our limited cursory and visual survey is outside the scope of this inspection. **The inspector will not be able to anticipate future events, conditions or changes in performance of any component or system due to changes in use or occupancy. The inspector makes no guarantee or warranty, express or implied, as to future performance of any item, system or component.**

I=Inspected

NI=Not Inspected

NP=Not Present

D=Deficient

I	NI	NP	D
---	----	----	---

-
-
-
-

B. Drains, Wastes, and Vents

Comments:

All components were found to be performing and in satisfactory condition on the day of the inspection.

General Photo(s) of Plumbing Cleanout(s)



Notice: Reporting the condition of drains, wastes and vent piping that is not completely visible and/or accessible or; reporting any defect or deficiency that requires extended use of the system to develop or does not become evident during our limited cursory and visual survey is outside the scope of the inspection. This is a limited cursory and visual survey of the accessible general conditions and circumstances present at the time of this inspection. Opinions are based on general observations made without the use of specialized tools or procedures. Therefore, the opinions expressed are one of apparent conditions and not of absolute fact and are only good for the date and time of this inspection. ***The inspector will not be able to anticipate future events, conditions or changes in performance of any component or system due to changes in use or occupancy. The inspector makes no guarantee or warranty, express or implied, as to future performance of any item, system or component.***

I=Inspected

NI=Not Inspected

NP=Not Present

D=Deficient

I	NI	NP	D
---	----	----	---

C. Water Heating Equipment

Energy Sources:

Capacity:

Comments:

Water Heater – *Energy Source: Gas*

Location: Attic

Approximate Capacity: 50 Gallons

Approximate Age: 2021 Approximate Design Life: 15 years

Brand Name: Rheem

This component appears to be performing adequately at the time of this inspection. It is achieving an operation, function, or configuration consistent with accepted industry practices for its age.

- The water heater flue (vent pipe) has inadequate clearance from combustibles. Double walled vent pipes should have at least 1-inch of clearance and single walled vent pipes should have at least 6-inches of clearance from combustibles.
- The roof level flue storm collar needs to be properly sealed to help prevent water intrusion into the structure.

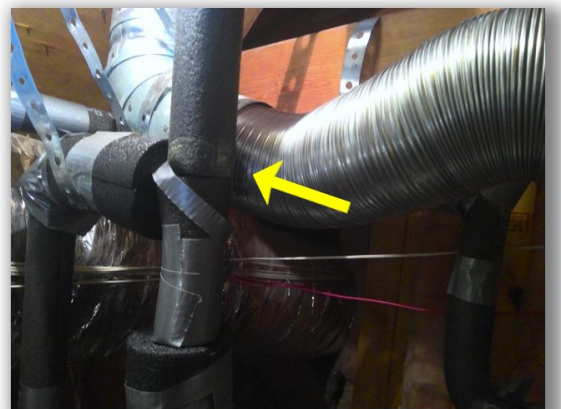

I=Inspected

NI=Not Inspected

NP=Not Present

D=Deficient

I NI NP D

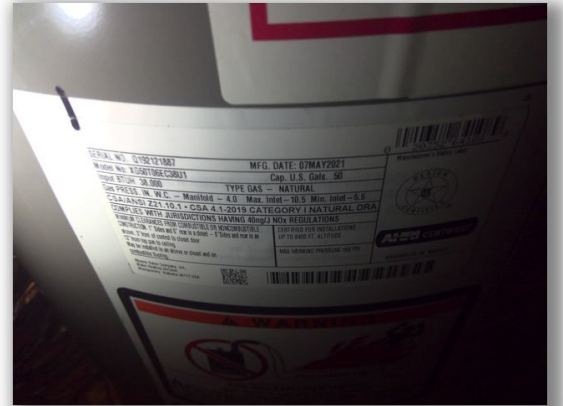

I=Inspected

NI=Not Inspected

NP=Not Present

D=Deficient

I	NI	NP	D
---	----	----	---

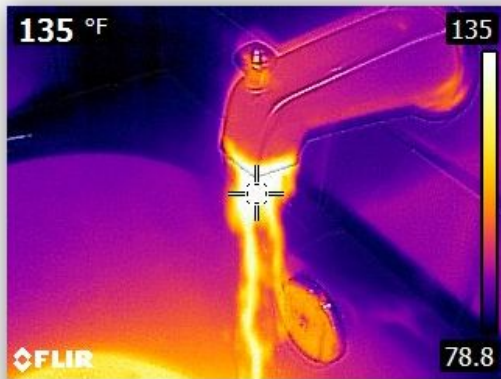

I=Inspected

NI=Not Inspected

NP=Not Present

D=Deficient

I	NI	NP	D
---	----	----	---

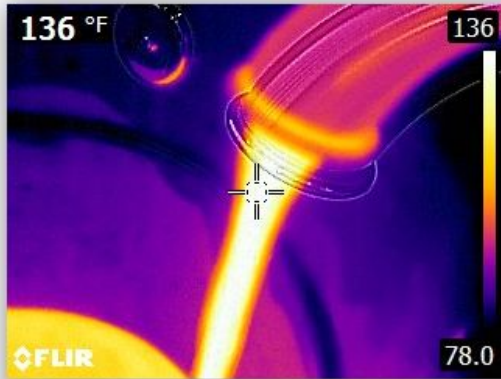

I=Inspected

NI=Not Inspected

NP=Not Present

D=Deficient

I NI NP D

- The water heater gas supply line is not equipped with a sediment trap just before the gas appliance connector. This condition does not meet current installation requirements and should be corrected.

Samples of correct sediment trap installations

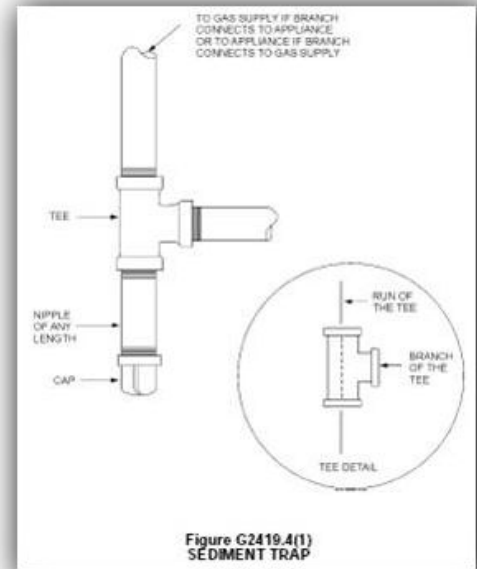

I=Inspected

NI=Not Inspected

NP=Not Present

D=Deficient

I	NI	NP	D
---	----	----	---

D. Hydro-Massage Therapy Equipment

Comments:

Location of GFCI: In master closet area.

- The hydro-massage therapy equipment appears to be inoperative at the time of this inspection. This condition should be further evaluated and corrected as necessary.



I=Inspected

NI=Not Inspected

NP=Not Present

D=Deficient

I NI NP D

- The access to the hydro-massage therapy equipment motor is not readily accessible and inspection of the equipment lines and motor could not be performed. This does not meet current installation standards.

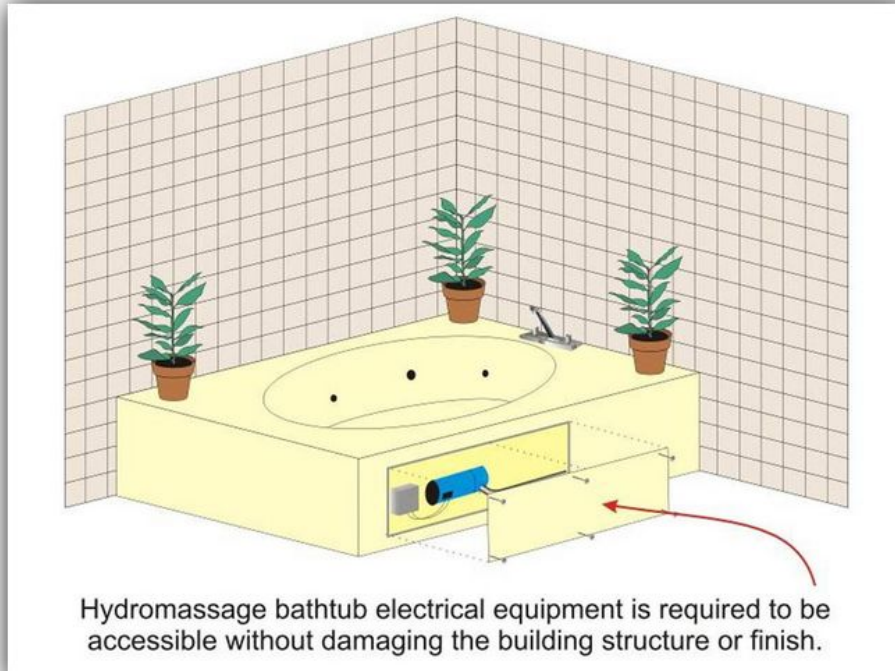

I=Inspected

NI=Not Inspected

NP=Not Present

D=Deficient

I	NI	NP	D
---	----	----	---

E. Gas Distribution System

Comments:

Movement was detected in the gas gauge at the time of the gas check. This indicates a gas leak is present and needs to be investigated and repaired as necessary by a Qualified Licensed Plumber. The observation made to support the rendering of this opinion are listed but not limited to the following:

- There was a gas leak detected at the outside gas meter. The inspector used a TUFF 8900 gas leak detector to locate the leak. This condition needs to be corrected for reason of safety.



I=Inspected

NI=Not Inspected

NP=Not Present

D=Deficient

I	NI	NP	D
---	----	----	---

General Photo(s) of Inspector Checking Gas Lines



Notice: The Inspector will use a combustible gas leak detector on accessible gas lines, joints, unions and connectors and report visible deficiencies found at the time and date of the inspection. The inspector inspects the gas lines from the point they enter the structure and will complete the inspection without digging, damaging property, permanent construction or building finish. When performing the inspection, the inspector will keep in consideration the age of the system and normal wear and tear from ordinary use when rendering opinions.

The inspector is not required to and will not inspect sacrificial anode bonding or for its existence. The Inspector is not licensed to and will not perform a pressure test on the gas line system. The Inspector cannot detect gas leaks below the finished grade (underground), construction voids, between the walls or behind fireplace hearths. Propane tanks will not be inspected. If any further concerns exist about possible gas line failure and/or deficiencies or code compliance, we recommend the buyer have the gas system further evaluated by the local controlling gas supplier and/or a qualified licensed master plumber prior to the expiration of any time limitations such as option or warranty periods.

I=Inspected

NI=Not Inspected

NP=Not Present

D=Deficient

I	NI	NP	D
---	----	----	---

V. APPLIANCES

A. Dishwashers

Comments:

Brand Name: Samsung

This component appears to be performing adequately at the time of this inspection.



B. Food Waste Disposers

Comments:

This component appears to be performing adequately at the time of this inspection.



I=Inspected

NI=Not Inspected

NP=Not Present

D=Deficient

I	NI	NP	D
---	----	----	---

-
-
-
-

C. Range Hood and Exhaust Systems

Comments:

Range Exhaust Systems

This component appears to be performing adequately at the time of this inspection.



I=Inspected

NI=Not Inspected

NP=Not Present

D=Deficient

I	NI	NP	D
---	----	----	---

D. Ranges, Cooktops, and Ovens

Comments:

Range Brand Name: Samsung

This component appears to be performing adequately at the time of this inspection.



I=Inspected

NI=Not Inspected

NP=Not Present

D=Deficient

I	NI	NP	D
---	----	----	---

-
-
-
-

E. Microwave Ovens

Comments:

Brand Name: Samsung

This component appears to be performing adequately at the time of this inspection.



I=Inspected

NI=Not Inspected

NP=Not Present

D=Deficient

I	NI	NP	D
---	----	----	---

F. Mechanical Exhaust Vents and Bathroom Heaters

Comments:

- One or more of the mechanical exhaust vent systems was observed to be terminating to the soffit / eave area. This is an "AS Built" condition that does not meet current manufacturers or mechanical installation standards.
- The mechanical exhaust vent fan appears to be inoperative in the upstairs hall bathroom.

G. Garage Door Operators

Comments:

H. Dryer Exhaust Systems

Comments:

This component appears to be performing adequately at the time of this inspection.



I=Inspected

NI=Not Inspected

NP=Not Present

D=Deficient

I NI NP D

VI. OPTIONAL SYSTEMS

A. Landscape Irrigation (Sprinkler) Systems

Comments:

When the system is operational, all of the sprinkler system associated components are inspected and operated in the manual settings only.

Note: Some municipalities now require moisture (rain/freeze) sensors to be installed on all new installation and existing sprinkler systems. Our company does not maintain a list of municipalities that require the installation of a moisture sensor. Please check with your municipality for moisture sensor requirements. Sprinkler system equipped with a moisture (rain/freeze) sensor Yes or No.

Total Number of Zones Wired: 2

Sprinkler System and Associated Components

General Pictures of Sprinkler System Back-flow Preventer, Control Box, & Rain Sensor



- I was unable to locate a moisture (rain / freeze) sensor device for the sprinkler system. This is an **“as-built” condition**, but Per TREC standards of practice we are required to report this condition as a deficiency.
- I was unable to locate an anti-siphon device or back-flow prevention device for the sprinkler water supply. An anti-siphon or back-flow prevention device is needed to help protect the systems water source from contamination. The homeowner should be consulted on the location of this device. If there is no anti-siphon or back-flow prevention device in place, one should be installed.

I=Inspected

NI=Not Inspected

NP=Not Present

D=Deficient

I	NI	NP	D
---	----	----	---

The sprinkler system and associated components should be further evaluated and/or serviced by a Licensed Irrigation Technician. The observations made to support the rendering of this opinion are listed but not limited to the following:

The sprinkler system did not respond to the controls when tested in the manual setting. The cause and remedy should be further evaluated and corrected as necessary.

- The control box was observed to be loosely secured to the exterior wall.



I=Inspected

NI=Not Inspected

NP=Not Present

D=Deficient

I NI NP D

-
-
-
-

B. Thermal Imaging / Infrared

Comments:

Thermal Imaging / Infrared

All components were found to be performing and in satisfactory condition on the day of the inspection.

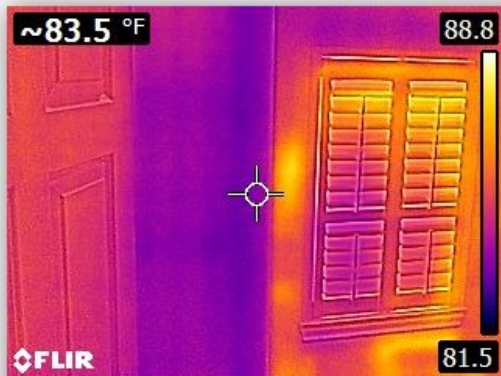
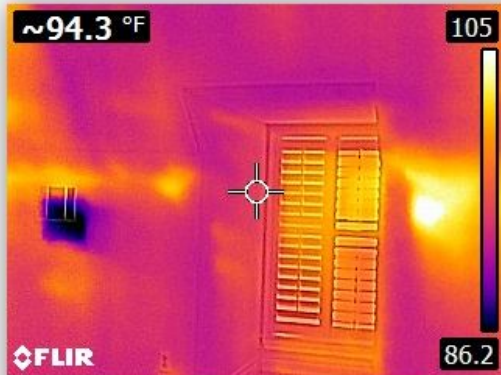
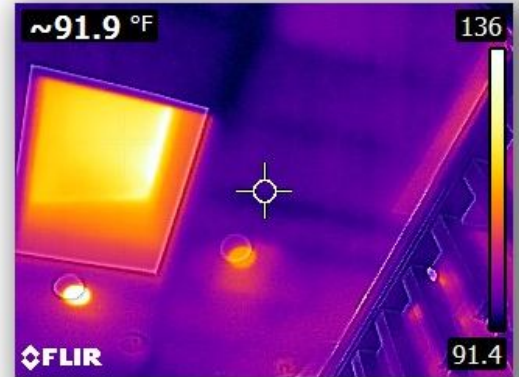

I=Inspected

NI=Not Inspected

NP=Not Present

D=Deficient

I NI NP D

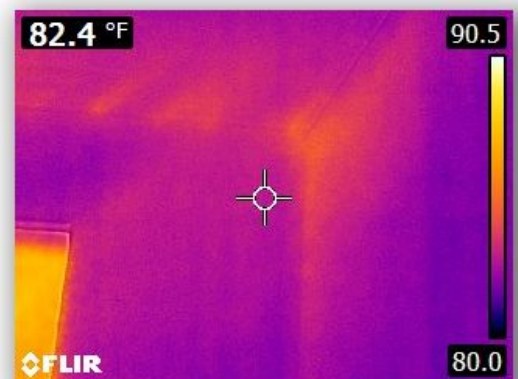
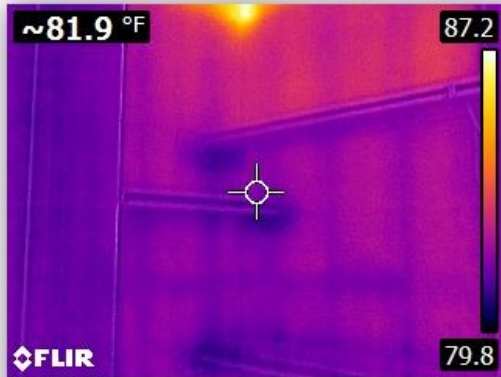

I=Inspected

NI=Not Inspected

NP=Not Present

D=Deficient

I NI NP D

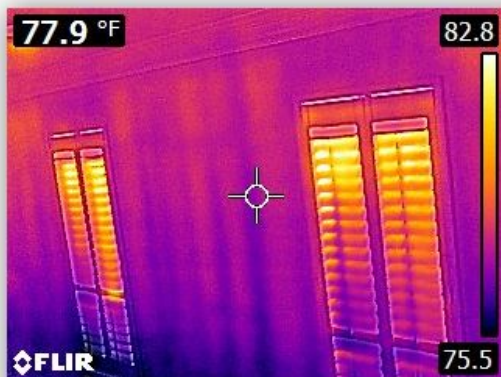
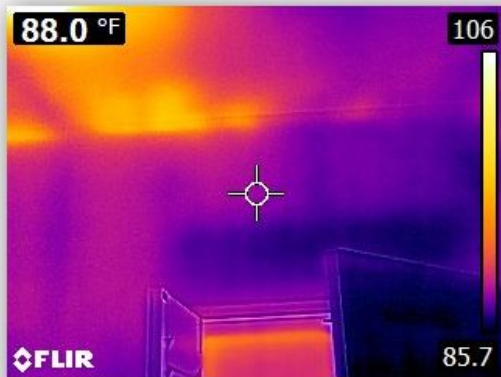

I=Inspected

NI=Not Inspected

NP=Not Present

D=Deficient

I	NI	NP	D
---	----	----	---

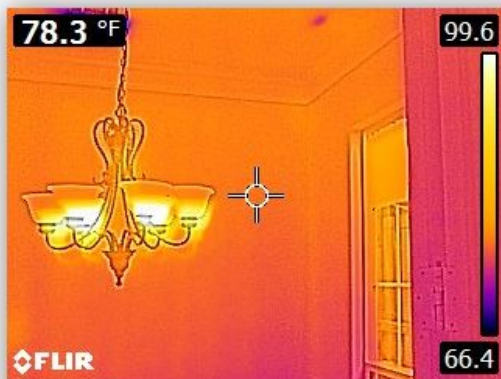

INSPECTION AGREEMENT
PLEASE READ THIS AGREEMENT CAREFULLY BEFORE SIGNING

This Inspection Agreement (herein after known as the Agreement) is entered into on this day, 08/27/2021, between Donald P Cunningham (herein known as the Client) and Texas Edge Home Inspections, PLLC. (herein known as the Inspector) for the purpose of performing a general property condition inspection concerning 7898 Weeping Willow Ct. (herein known as the property).

I. SCOPE OF SERVICES

- A. A real estate inspection is a non-technically exhaustive, limited visual survey and basic performance evaluation of the systems and components of a building using normal controls and does not require the use of specialized equipment or procedures. The purpose of the inspection is to provide the Client with information regarding the general condition of the Property at the time of inspection.
- B. In exchange for the inspection fee (\$) paid by the Client, the Inspector agrees to provide the Client with an Inspection Report setting out the Inspector's professional opinions concerning the condition of the Property further described in the report. The inspection will be performed in accordance with the Standards of Practice promulgated by the Texas Real Estate Commission. Inspector will attempt to identify major defects and problems with the Property. However, Client acknowledges that the Inspection Report may not identify all defects or problems.
- C. The inspection is limited to those items which are easily accessible, seen, viewed or capable of being approached, entered and/or operated by the Inspector at the time of the inspection as set out in the Inspection Report. The Inspector will not climb over obstacles, move furnishings or large, heavy, or fragile objects, remove walls, floors, wall coverings, floor coverings and other obstructions in order to inspect concealed items. The inspector will not turn on decommissioned equipment, systems, utility services. Systems, components and conditions which are not specifically addressed in the Inspection Report are excluded.
- D. The Inspection Report may indicate one of the following opinions of the Inspector regarding a particular item:
 - 1. The item is performing its intended function, achieving an operation, function or configuration relative to accepted industry standard practices with consideration of age and normal wear and tear from ordinary use at the time of the inspection;
 - 2. The item is in need of replacement, maintenance or repair; or
 - 3. Further evaluation by an expert is recommended.

II. INSPECTION REPORT

- A. The Inspection Report provided by the Inspector will contain the Inspector's professional, good-faith opinions concerning the need for repair or replacement of certain observable items. All statements in the report are the Inspector's opinions and should not be construed as statements of fact or factual representations concerning the Property. **By signing this Agreement, the Client understands that the services provided by the Inspector fall within the Professional Services Exemption of the Texas Deceptive Trade Practices Act ("DTPA") and agrees that no cause of action exists under the DTPA related to the services provided.**
- B. **Unless specifically stated, the report WILL NOT INCLUDE and should not be read to indicate OPINIONS AS TO;**
 - 1. the presence, absence, or risk of environmental conditions such as asbestos, lead-based paint, **MOLD**, mildew, corrosive or contaminated drywall "Chinese Drywall" or any other environmental hazard, environmental pathogen, carcinogen, toxin, mycotoxin, pollutant, fungal presence or activity, poison, presence of toxic or hazardous waste or substances;
 - 2. presence or absence of pests, termites, or other wood-destroying insects or organisms;
 - 3. **COMPLIANCE WITH compliance with any ordinances, statutes or restrictions, CODE, listing, testing or protocol authority, utility sources, property association guidelines or requirements, manufacturer or regulatory requirements;**
 - 4. insurability, efficiency warrantability, suitability, adequacy, compatibility, capacity, durability, quality reliability, marketability, operating costs, recalls, counterfeit products, product lawsuits, age, energy efficiency; or
 - 5. anticipate future life or future events or changes in performance of any item inspected.
- C. The Inspection Report is not a substitute for disclosures by sellers and real estate agents. Said disclosure statements should be carefully investigated for any material facts that may influence or effect the desirability and/or market value of the Property.
- D. As noted above, the Inspection Report may state that further evaluation of certain items is needed by an expert in the field of the item inspected. By signing this Agreement, Client acknowledges that qualified experts may be needed to further evaluate such items as structural systems, foundations, grading, drainage, roofing, plumbing, electrical systems, HVAC, appliances, sprinkler systems pool system and components, fire/smoke detection systems, septic systems and other observable items as noted in the report. Any such follow-up should take place prior to the expiration of any time limitations such as option or warranty periods.

III. DISCLAIMER OF WARRANTIES

The inspector makes no guarantee or warranty, express or implied, as to any of the following:

1. That all defects have been found or that the Inspector will pay for repair of undisclosed defects;
2. That any of the items inspected are designed or constructed in a good and workmanlike manner;
3. That any of the items inspected will continue to perform in the future as they are performing at time of the inspection; and
4. That any of the items inspected are merchantable or fit for any particular purpose.

IV. LIMITATION OF LIABILITY

BY SIGNING THIS AGREEMENT, CLIENT ACKNOWLEDGES THAT THE INSPECTION FEE PAID TO THE INSPECTOR IS NOMINAL GIVEN THE RISK OF LIABILITY ASSOCIATED WITH PERFORMING HOME INSPECTIONS IF LIABILITY COULD NOT BE LIMITED. CLIENT ACKNOWLEDGES THAT WITHOUT THE ABILITY TO LIMIT LIABILITY, THE INSPECTOR WOULD BE FORCED TO CHARGE CLIENT MUCH MORE THAN THE INSPECTION FEE FOR THE INSPECTOR'S SERVICES. CLIENT ACKNOWLEDGES BEING GIVEN THE OPPORTUNITY TO HAVE THIS AGREEMENT REVIEWED BY COUNSEL OF HIS OR HER OWN CHOOSING AND FURTHER ACKNOWLEDGES THE OPPORTUNITY OF HIRING A DIFFERENT INSPECTOR TO PERFORM THE INSPECTION. BY SIGNING THIS AGREEMENT, CLIENT AGREES TO LIABILITY BEING LIMITED TO THE AMOUNT OF THE INSPECTION FEE PAID BY THE CLIENT. \$

V. DISPUTE RESOLUTION

In the event a dispute arises regarding an inspection that has been performed under this agreement, the Client agrees to notify the Inspector within ten (10) days of the date the Client discovers the basis for the dispute so as to give the Inspector a reasonable opportunity to reinspect the property. Client agrees to allow reinspection before any corrective action is taken. Client agrees not to disturb or repair or have repaired anything which might constitute evidence relating to a complaint against the Inspector. Client further agrees that the Inspector can either conduct the reinspection himself or can employ others (at Inspector's expense) to reinspect the property, or both. In the event a dispute cannot be resolved by the Client and the Inspector, the parties agree that any dispute or controversy shall be resolved by mandatory and binding arbitration administered by the American Arbitration Association ("AAA") pursuant to Chapter 171 of the Texas Civil Practice & Remedies Code and in accordance with this arbitration agreement and the commercial arbitration rules of the AAA.

VI. ATTORNEY'S FEES

The Inspector and the Client agree that in the event any dispute or controversy arises as a result of this Agreement, and the services provided hereunder, the prevailing party in that dispute shall be entitled to recover all of the prevailing party's reasonable and necessary attorneys' fees and costs incurred by that party.

VII. EXCLUSIVITY

The Inspection Report is to be prepared exclusively for the Client and is not transferable to anyone in any form. Client gives permission for the Inspector to discuss report findings with real estate agents, specialists, or repair persons for the sake of clarification. A copy of the Inspection Report may be released to the buyers Real Estate Agent.

BY MY SIGNATURE BELOW, I ACKNOWLEDGE THAT I HAVE READ THIS CONTRACT AND THAT THE INSPECTOR DID NOT COERCE, PRESSURE OR RUSH ME TO EXECUTE THIS CONTRACT WITHOUT OPPORTUNITY TO FULLY REVIEW THE CONTRACT AND IF NECESSARY HAVE THE CONTRACT REVIEWED BY AN ATTORNEY; THAT INSPECTOR AGREED TO RESCHEDULE THE INSPECTION IN THE EVENT I REQUIRED ADDITIONAL TIME TO REVIEW THE CONTRACT; THAT I UNDERSTAND THE TERMS AND CONDITIONS AND THAT I AGREE TO BE BOUND BY THESE TERMS AND CONDITIONS. IF CLIENT IS MARRIED, CLIENT REPRESENTS THAT THIS OBLIGATION IS A FAMILY OBLIGATION INCURRED IN THE INTEREST OF THE FAMILY.

Client Signature: _____

Date: 08/27/2021

Inspector: Matthew Brading

RESIDENTIAL WDI CONSULTING AGREEMENT

Pest Inspection Network, P. O. Box 700906, San Antonio, TX 78270
Info@pestInspectionNetwork.com www.PestInspectionNetwork.com
210-559-3929

Last Updated 03/23/2021

Property Address 7898 Weeping Willow Ct.

THIS IS A LEGAL AGREEMENT. PLEASE READ CAREFULLY BEFORE SIGNING. YOU HAVE THE RIGHT AND IT IS PRUDENT TO CONSULT AN ATTORNEY PRIOR TO SIGNING THIS AGREEMENT IF YOU DO NOT FULLY UNDERSTAND THE CONDITIONS.

Important Limitations and Disclaimers

This Property WDI Inspection Report reports on only the address listed and only on the current condition of those items as of the date of inspection. This report reflects only if the property inspected are observed to have active infestation or conducive conditions at the time of inspection. This report reflects only those items that are reasonably observable at the time of inspection. NO REPRESENTATION OR COMMENT is made concerning any latent defect or defects not reasonably observable at the time of the inspection or of items which require the removal of major or permanent coverings. For example, but without limitation, recent repairs, painting or covering may conceal prior or present insect, leak or other damage which is not reasonably observable by the inspector and no representation or comment can be made. NO REPRESENTATION IS MADE CONCERNING ANY OTHER CONDITION OR THE FUTURE PERFORMANCE OF THE STRUCTURE. NO REPRESENTATION IS MADE AS TO ITEMS NOT SPECIFICALLY COMMENTED UPON. ALL WARRANTIES EXPRESSED OR IMPLIED, NOT SPECIFICALLY STATED HEREIN ARE EXCLUDED AND DISCLAIMED. If a comment is made concerning the condition of any item, the Client is URGED to contact a qualified SPECIALIST to make further inspections or evaluations of that item. Client must notify Pest Inspection Network, Inc. in writing of any complaints within seven (7) days of the date of inspection and must thereafter allow prompt re-inspection of the item in question. Otherwise, all claims for damages arising out of such complaint are waived by Client. If Client institutes any legal action concerning this inspection, and fails to prevail on all causes of action alleged, Client shall be liable to Pest Inspection Network, Inc. for all of its attorney's fees incurred in such action. Actual damages for any breach of contract or warranty, negligence or otherwise are limited to the amount of the inspection fee paid. The Client, by accepting this Report or relying upon it in any way, expressly agrees to these Limitations and Disclaimers.

Client further acknowledges, agrees, and authorizes Pest Inspection Network, Inc. to provide their contact information (including telephone number) to a third-party service provider ("TSP"), with which Pest Inspection Network, Inc. may affiliate with to offer the client additional value-added services. Pest Inspection Network, Inc. may in some cases be compensated for making these arrangements in order to keep inspection prices at a minimum.

For more information concerning your rights, contact the Consumer Protection Division of the Attorney General's Office, your local District or County Attorney, or the attorney of your choice.

Inspector and / or Inspecting company agree to provide inspection services in accordance with this Agreement and render professional opinions for the purpose of informing the Client(s) listed on the order form (individually or collectively the "Client") of major deficiencies in the condition of the referenced property submitted on the order form (the "Property"). In consideration for the inspection services, the Client agrees to pay the inspection fee for this Agreement prior to completion of the inspection and presentation of the WDI (Termite) Inspection Report. Additional fees apply for return visits that may be required to complete an inspection where items or systems we're not ready or deemed safe to originally inspect. All return visit fees are charged at a rate of a **minimum \$50 fee. Additional fees for travel and time may apply** depending on the quantity of items to inspect and property location.

What is Inspected: In exchange for an Inspection Fee as agreed to (**Services Provided**), the Inspector will (a) inspect the Property. The inspection shall include a **non-exhaustive** evaluation of the property. The Inspector will perform an inspection of those items that are visible and safely accessible **as determined by the Inspector**. Areas and/or items deemed to be inaccessible and or unsafe to inspect as determined by the Inspector. The inspection will be a **non-destructive** and practical evaluation of the Property and as are apparent on the date of the inspection. The Inspector will not enter or climb upon unsafe areas that may potentially endanger the Inspector or the property, in his sole judgment.

What is Not Inspected (Agreed Departures): The following specific limitations apply but should not be considered as a totally exhaustive list **Unless expressly stated otherwise, Inspector does not inspect**, items where access is limited or prevented by furniture, personal belongings, or similar obstructions.

Client specifically agrees to hold Inspector harmless from any claims or liability regarding any areas that have been purposely concealed, covered, touched up or otherwise hidden on the premises and or unreported or withheld from the Sellers Disclosure documents.

Client agrees the sole recourse is against the responsible parties thru civil action. The inspection intends to reduce but will not eliminate risk; therefore, the standard inspection does not identify all defects or problems (visible or concealed). The Client agrees that such non-reporting does not constitute any actionable representation or omission and specifically waives any and all claims at law or in equity, in connection with any such reporting. This agreement and report will not include, and should not be read or interpreted, to determine the insurability or merchantability of any item or items inspected.

THE INSPECTOR HEREBY DISCLAIMS ALL EXPRESS AND IMPLIED WARRANTIES TO THE FULLEST EXTENT ALLOWED BY LAW, INCLUDING, BUT NOT LIMITED TO, WARRANTIES OF MERCHANTABILITY AND FITNESS FOR A PARTICULAR PURPOSE.

The Report and Inspection Findings: The written report including any and all photographs or digital recordings taken during the time of inspection remain the copyrighted property of the Inspector. The Client agrees distribution of the completed report shall be solely to persons involved with this transaction; including, but not limited to, real estate professionals representing the seller and/or client, attorneys of record representing the seller and/or client, the Title Inspector and/or lender representing the Client. Distribution, use of or sale of this copyrighted report to any other parties is expressly prohibited. Client specifically gives permission to the Inspector to distribute the report per the Clients direction and to discuss report findings with any and all parties related to this transaction. Please note that the Inspector reserves the right to provide additional addendums, clarifications or modifications to the original inspection report. Any such addendums, clarifications or modifications shall be delivered to the Client no later than 48 hours from the time of the original inspection report. Oral opinions provided by the Inspector are partial in context and superseded by the written report and any addendums, clarifications or modifications forwarded to the client as agreed above.

Client Responsibilities: Client agrees to carefully read the entire inspection report and any and all addendums and to confer with all recommended specialists noted in the inspection report. Failure by the client to secure the services of recommended specialists is done so at the sole risk of the Client and the Inspector shall be hereby released from any and all claims for non-disclosure that may be related or consequential to deficiencies noted in the inspection

report.

It is the Client's responsibility to contact an insurance agent to confirm the property is fully insurable without reservation as the Inspector does not guarantee or certify the building and/or property is insurable. It is the Client's responsibility to contact and secure the services and guidance of legal counsel, counsel from a qualified real estate agent and counsel from contractors and repairmen in negotiating repair needs and/or satisfying that all deficiencies that exist on the property are repaired and/or negotiated to the Client's satisfaction prior to closing.

Failure to seek appropriate guidance is the direct responsibility of the Client and the Inspector shall be fully released from any and all associated claims that may be charged against the Inspector as a result of the Client's failure to secure such guidance.

Enforceability: If any portion of this Agreement is found to be invalid or unenforceable by any court or arbitrator, the remaining terms shall remain in force between the parties. Any "typos" or misspelled words are considered just a "typo" and should be considered as intended.

Subrogation Clause: The Client specifically waives all subrogation rights or interests that may be afforded to the seller, lenders, spouses, legal Partners, beneficiaries, insurance companies or any other party that may hold an interest in the property or estate inspected under this agreement. The Client specifically agrees to hold harmless, fully defend and satisfy any and all such claims that may arise against the Inspector out of the performance of the inspection and inspection report provided.

Claim Notice Procedure: The Client understands and agrees that any claim(s) or complaint(s) arising out of or related to any alleged act(s) or omission(s) of the Inspector, in connection with the services provided, shall be reported to the Inspector in writing and in reasonable detail within ten (10) business days of discovery. Unless there is an emergency condition, the Client agrees to allow the Inspector without hindrance a reasonable period of time to investigate the claim(s) or complaint(s) by, and among other things, a re-inspection of the condition(s) or item(s), before the Client or anyone acting on behalf of the Client, repairs, replaces, alters, or modifies the system(s) or component(s) that are the subject matter of the claim or complaint. The Client understands and agrees that the Client's failure to timely notify the Inspector and allow adequate time to investigate the conditions prior to any repairs or alterations as stated above, shall constitute a complete waiver and relinquishing of any and all claims that the Client (complainant) may have against the Inspector, as relating to the alleged act(s) or omission(s), unless otherwise prohibited by law. The Client agrees that no claim, demand, or action, whether sounding in contract or in tort, may be brought to recover damages against the Inspector **more than (90) calendar days after the date of the inspection report.**

The Client hereby acknowledges that the Inspector is licensed by the state of Texas and is recognized in the industry and by the state of Texas as a Professional Inspector for the purposes of DTPA (Deceptive Trade Practice). The professional opinions of the Inspector provided in verbal or written format are considered professional opinions, therefore exempted from liability under DTPA section 17.49

Arbitration of Disputes: All parties agree that if a dispute or claim arises from this agreement or the inspection performed by the Inspector and it cannot be amicably settled through direct communication, that any and all disputes shall be settled thru mediation under the guidelines set forth under Texas law. Both parties shall share equally in the cost of mediation. In the event mediation is unsuccessful, both parties voluntarily agree to binding arbitration by a single, conflict free, mutually agreeable arbitrator, and shall use the procedural rules, but not the administration of the American Arbitration Association per Construction Industry Arbitration. If the parties are unable to agree on the appointment of a mediator and/or arbitrator, either party, without waiving the right to enforce binding arbitration, may petition a court of general jurisdiction in Bexar County, Texas to appoint a mediator and/or arbitrator. Any arbitration proceeding shall be held in Bexar County, Texas. The Client and the Inspector shall share equally in the costs of the arbitrator, subject to the arbitrator's right to award such costs as provided below. **The Client expressly waives all rights to a trial by jury in lieu of mediation and/or arbitration to settle any and all claims.**

Fees and Costs associated with Disputes: In the event the Client files a claim or initiates a mediation or arbitration proceeding against the Inspector or the Client agrees to pay any and all fees, including but not limited to: mediator or arbitrator fees, costs of expert witnesses, legal defense fees, deposition fees and any and all other such expenses incurred by the Inspector, if the Client is not the prevailing party in the dispute on **ALL** claims.

LIMITATION OF LIABILITY

Client understands that this is not a technically exhaustive inspection. **A technically exhaustive inspection is available that involves the hiring of specialists in each area of the inspection process.** These inspections take approximately 1-2 weeks to schedule, **do not carry any limits of liability as noted in this Agreement** and are offered at a minimum starting fee of \$ **5,000.00 (Five thousand dollars).**

Client understands that the inspection fee paid to the Inspector for a **NON-technically exhausting** inspection is nominal given the risk of liability associated with performing inspections if such liability could not be limited. Accordingly, by signing below in person or by digital proxy or by relying on the report in any way, Client agrees that the Inspector is not performing a technically exhaustive inspection and that the maximum liability incurred by the Inspector for any and all claims relating to damages or errors or omissions **SHALL BE LIMITED TO A REFUND OF THE ENTIRE FEE PAID TO THE INSPECTOR FOR THE INSPECTION.**

This limitation applies to any and all damages sought by Client, including actual, consequential, exemplary, special or incidental damages, attorney's fees, costs, and expenses. This limitation of liability is binding upon the Client's heirs, successors, assigns, and any other party claiming rights under this Agreement, including those claiming by, through, or under Client.

Choice of Law: This Agreement shall be construed, governed, and enforced in accordance with the laws of the State of Texas.

Entire Agreement: This Agreement represents the entire agreement between the Client and the Inspector and/or Pest Inspection Network, Inc. No oral agreements, understandings, or representations shall change, modify, or amend any part of this Agreement. No changes or modifications to this Agreement shall be enforceable unless they are in writing and signed by both the Client and the Inspector including an authorized representative of Pest Inspection Network, Inc.

Acceptance: This Agreement is solely between the Inspector, Pest Inspection Network, Inc. and the Client for whom the inspection was performed. Due to the rapid pace that many real estate transactions occur at, it is not technically possible in some cases for Clients to always attend inspections. If the Client is not present during the inspection process, and/or fails to sign and return a fully executed copy of the last page of this Agreement prior to or at the time of inspection, the Client's acceptance of the Property Inspection Report constitutes an implied acceptance of this entire Agreement in full.

SERVICES PROVIDED

Payment: Payment of the above sums are due upon completion of the onsite inspection. In the event of any default in payment, unpaid sums shall bear interest at the lesser of the highest legal rate or 1.5% per month. All returned checks are subject to a \$50 returned check fee. Client shall be held responsible for all necessary collection fees including but not limited to legal fees, collection agencies etc. on any unpaid fees or returned checks.

The Client has read and understands the content, terms, and conditions of this Agreement, including, but not limited to, the limitations of liability, complaint

procedures, arbitration clause, subrogation clause and limitation periods. The Client has the right to have this Agreement reviewed by an attorney of his/her choice prior to signing and the right to choose another Inspector if the terms and conditions of this Agreement are unsatisfactory.

The Client certifies to the Inspector to have the legal authority to enter this contract on behalf of a spouse, life partner and/or any other third party. The Client agrees to fully assume any and all obligations or legal liability to successfully defend the Inspector against any and all claims that may arise or be charged against the Inspector by such spouses, partners or other third parties that may have a legal interest in the property or this agreement.

I have read, agree with and FULLY and COMPLETELY understand the provisions of this disclaimer and that this inspection is not a warranty or guarantee. This inspection is essentially visual, it is not technically exhaustive, and it does not imply that every defect will be discovered. It is only a statement of opinion and/or condition as of and on this date.

Client Printed Name: Donald P Cunningham

Client Signature: Clients acceptance of the Property Inspection Report constitutes an implied acceptance of this entire Agreement in full.

Date: 08/06/2021

Email: _____

7898 Weeping Willow Ct. Houston 77057
Inspected Address City Zip Code

1A. **Pest Inspection Network, Inc.** 1B. **0783068**
Name of Inspection Company SPCS Business License Number

1C. **26504 Tuscan Vw. San Antonio TX 78261 210-559-3929**
Address of Inspection Company City State Zip Telephone No.

1D. **Matthew Brading** 1E. Certified Applicator (check one)
Name of Inspector (Please Print) Technician
Inspector Phone: Inspector E-Mail: **matt@texasedgeinspect.com**

1F. **Friday, August 6, 2021**
Inspection Date

2. **Donald P Cunningham** Seller Agent Buyer Management Co. Other **Client**
Phone Client E-Mail
Name of Person Purchasing Inspection

3. **Unknown**
Owner/Seller

4. REPORT FORWARDED TO: Title Company or Mortgagee Purchaser of Service Seller Agent Buyer
(Under the Structural Pest Control regulations only the purchaser of the service is required to receive a copy)

The structure(s) listed below were inspected in accordance with the official inspection procedures adopted by the Texas Structural Pest Control Service. This report is made subject to the conditions listed under the Scope of Inspection. A diagram must be attached including all structures inspected.

5A. **The Main House**
List structure(s) inspected that may include residence, detached garages and other structures on the property. (Refer to Part A, Scope of Inspection)

5B. Type of Construction:
Foundation: Slab Pier and Beam Pier Type: _____ Basement Other: _____
Siding: Wood Hardie Plank Brick Stone Stucco Other: _____
Roof: Composition Wood Shingle Metal Tile Other _____

6A. This company has treated or is treating the structure for the following wood destroying insects: **N/A**

If treating for subterranean termites, the treatment was: Partial Spot Bait Other
If treating for drywood termites or related insets, the treatment was: Full Limited

6B. **N/A** **N/A** **N/A**
Date of Treatment by Inspecting Company Common Name of Insect Name of Pesticide, Bait or Other Method
This company has a contract or warranty in effect for control of the following wood destroying insects:
Yes No List Insects: **Pest Inspection Network carriers No Warranty on this property expressed or implied.**
If "Yes", copy(ies) of warranty and treatment diagram must be attached.

Neither I nor the company for which I am acting have had, presently have, or contemplate having any interest in the purchase of sale of this property. I do further state that neither I nor the company for which I am acting is associate in any way with any party to this real estate transaction.

Signatures:
7A.  License #0793815
Inspector (Technician or Certified Applicator Name and License Number)

Others Present:
7B. _____
Apprentices, Technicians, or Certified Applicators (Names) and Registration/License Number(s)

7898 Weeping Willow Ct.

Houston

77057

Inspected Address

City

Zip Code

Notice of Inspection Was Posted At or Near:

- 8A. Electric Breaker Box
- 8B. Date Posted: 08/16/2021
- Water Heater Closet
- Beneath the Kitchen Sink

9A. Were any areas of the property obstructed or inaccessible? Yes No
 (Refer to Part B & C, Scope of Inspection) If "Yes" specify in 9B.

9B. The obstructed or inaccessible areas include but are not limited to the following:

- | | | | |
|---|---|--|---|
| Attic <input type="checkbox"/> | Behind Storage In Garage <input type="checkbox"/> | Construction Voids <input checked="" type="checkbox"/> | Foundation Corner Pops <input type="checkbox"/> |
| Insulated Area of Attic <input checked="" type="checkbox"/> | Behind Furniture <input type="checkbox"/> | Under Floor Covering <input checked="" type="checkbox"/> | Cosmetic Beam Repair <input type="checkbox"/> |
| Attic Partially Accessible <input checked="" type="checkbox"/> | Recent Renovations <input type="checkbox"/> | Plumbing Areas <input checked="" type="checkbox"/> | Planter box abutting structure <input type="checkbox"/> |
| Deck <input type="checkbox"/> | Sub Floors <input checked="" type="checkbox"/> | Slab Joints <input checked="" type="checkbox"/> | Crawl Space <input type="checkbox"/> |
| Soil Grade Too High <input type="checkbox"/> | Heavy Foliage <input checked="" type="checkbox"/> | Eaves <input checked="" type="checkbox"/> | Weepholes <input type="checkbox"/> |
| Raised Concrete, Brick and/or Stone at Patio/Porch(s) <input checked="" type="checkbox"/> | Debris Near Structure <input type="checkbox"/> | Foundation Plumbing Penetrations <input checked="" type="checkbox"/> | |

Other Specify: The south area of the structure was no accessible

10A. Conditions conducive to wood destroying insect infestation? Yes No
 (Refer to Part J, Scope of Inspection) If "Yes" specify in 10B.

10B. Conducive Conditions include but are not limited to:

- | | | |
|---|--|---|
| Wood to Ground Contact (G) <input type="checkbox"/> | Form boards left in place (I) <input type="checkbox"/> | Excessive Moisture (J) <input type="checkbox"/> |
| Debris under or around structure (K) <input type="checkbox"/> | Footing too low or soil line too high (L) <input type="checkbox"/> | Wood Rot (M) <input checked="" type="checkbox"/> |
| Planter box abutting structure (O) <input type="checkbox"/> | Wood Pile in Contact with Structure (Q) <input checked="" type="checkbox"/> | Heavy Foliage (N) <input type="checkbox"/> |
| Insufficient ventilation (T) <input type="checkbox"/> | Wooden Fence in Contact with the Structure (R) <input checked="" type="checkbox"/> | Other (C) <input type="checkbox"/> Specify: _____ |

11. Inspection Reveals Visible Evidence in or on the structure:

	Active Infestation		Previous Infestation		Previous Treatment	
11A. Subterranean Termites	Yes <input type="checkbox"/>	No <input checked="" type="checkbox"/>	Yes <input type="checkbox"/>	No <input checked="" type="checkbox"/>	Yes <input type="checkbox"/>	No <input checked="" type="checkbox"/>
11B. Drywood Termites	Yes <input type="checkbox"/>	No <input checked="" type="checkbox"/>	Yes <input type="checkbox"/>	No <input checked="" type="checkbox"/>	Yes <input type="checkbox"/>	No <input checked="" type="checkbox"/>
11C. Formosan Termites	Yes <input type="checkbox"/>	No <input checked="" type="checkbox"/>	Yes <input type="checkbox"/>	No <input checked="" type="checkbox"/>	Yes <input type="checkbox"/>	No <input checked="" type="checkbox"/>
11D. Carpenter Ants	Yes <input type="checkbox"/>	No <input checked="" type="checkbox"/>	Yes <input type="checkbox"/>	No <input checked="" type="checkbox"/>	Yes <input type="checkbox"/>	No <input checked="" type="checkbox"/>
11E. Other Wood Destroying Insects	Yes <input type="checkbox"/>	No <input checked="" type="checkbox"/>	Yes <input type="checkbox"/>	No <input checked="" type="checkbox"/>	Yes <input type="checkbox"/>	No <input checked="" type="checkbox"/>

Specify: _____

11F. Explanation of signs of previous treatment (including pesticides, baits, existing treatment stickers or other methods) identified:

N/A

11G. Visible evidence of: N/A has been observed in the following areas: N/A

If there is visible evidence of active or previous infestation, it must be noted. The type of insect(s) must be listed on the first blank and all identified infested areas of the property inspected must be noted in the second blank. (Refer to Part D, E & F, Scope of Inspection)

12A. Corrective treatment recommended for active infestation or evidence of previous infestation with no prior treatment

as identified in Section 11. (Refer to Part G, H and I, Scope of Inspection) Yes No

12B. A preventive treatment and/or correction of conducive conditions as identified in 10A & 10B is recommended as follows: Yes No

Specify reason: Wood debris stored near the structure should be removed. If active wood destroying insects are discovered during the correction process, treatment will be required. Wood fence abutting the structure can be conducive to termite activity. Recommend Monitoring and treating as needed. Rotted wood can be conducive for wood destroying insects. Recommend replacing rotted wood. If active wood destroying insects are discovered during the correction process, treatment will be required.

Refer to Scope of Inspection Part J

Diagram of Structure(s) Inspected

The inspector must draw a diagram including approximate perimeter measurements and indicate active or previous infestation and type of insect by using the following codes: E-Evidence of infestation; A-Active; P-Previous; D-Drywood Termites; S-Subterranean Termites; F-Formosan Termites; C-Conductive Conditions; B-Wood Boring Beetles; H-Carpenter Ants; Other(s) - Specify _____

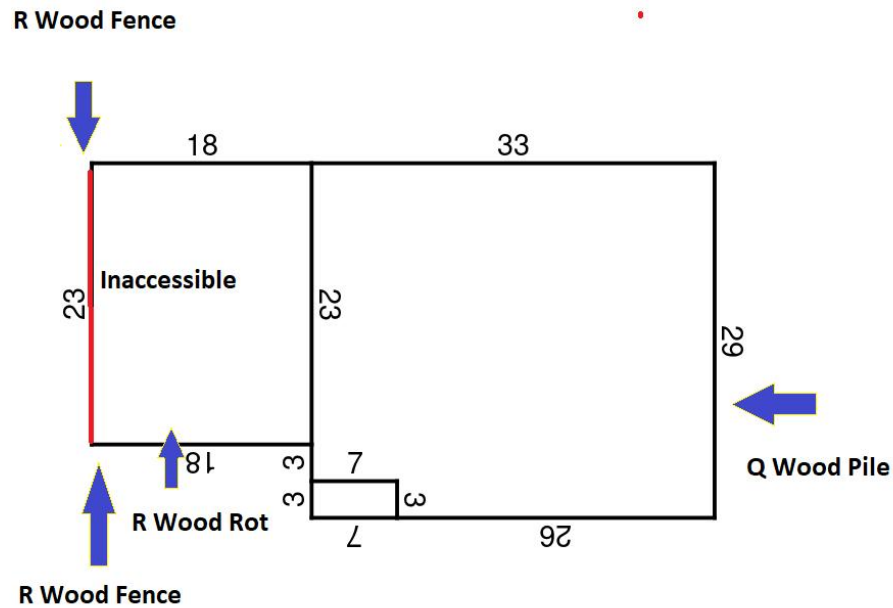

Explanation of "**Conductive Conditions**" codes on drawing.

Wood to Ground Contact (**G**)

Form boards left in place (**I**)

Excessive Moisture (**J**)

Debris under or around structure (**K**)

Footing too low or soil line too high (**L**)

Wood Rot (**M**)

Heavy Foliage (**N**)

Planter box abutting structure (**O**)

Wood Pile in Contact with Structure (**Q**)

Wooden Fence in Contact with the Structure (**R**)

Insufficient ventilation (**T**)

Other (**C**)

Additional Comments _____

7898 Weeping Willow Ct.
Inspected Address

Houston
City

77057
Zip Code

Statement of Purchaser

I have received the original or a legible copy of this form. I have read and understand any recommendations made. I have also read and understand the "Scope of Inspection." I understand that my inspector may provide additional information as an addendum to this report.

If additional information is attached, list number of pages: See WDI Photo Page

Signature of Purchaser of Property or their Designee _____

Date _____

Customer or Designee not Present **Buyers Initials** _____

WDI Photos

