

TABLES

PRICEBOOK

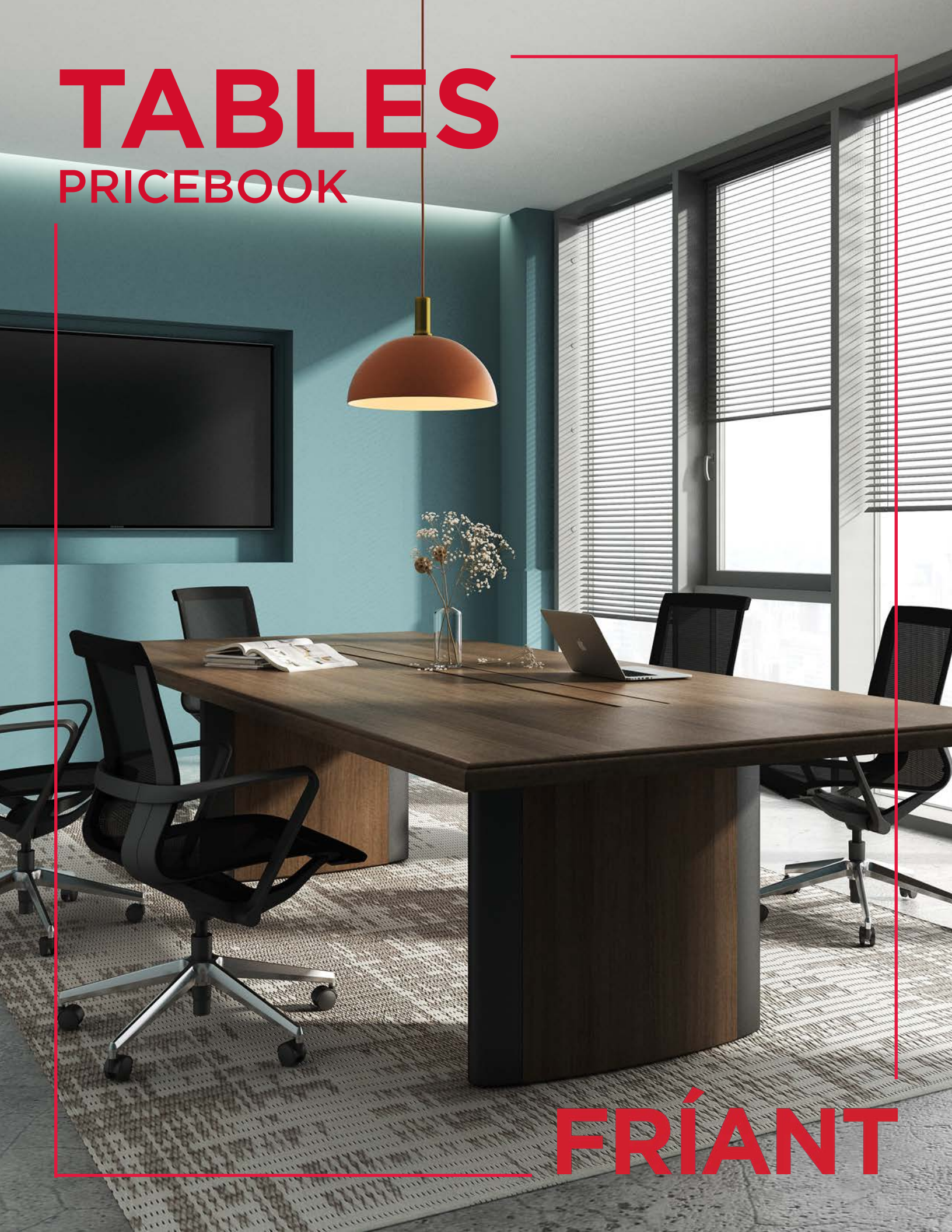

FRÍANT

TABLES

PRICEBOOK

LUNE

NESTING TABLES

Overview	3
Pricing	8
Finishes	10

SCOPE

OCCASIONAL TABLES

Overview	12
Pricing	17
Finishes	23

ROKE AND RAFFE

TABLES

Overview	25
Pricing	27
Finishes	28

METAL BASE

TABLES

Overview	29
Pricing	32
Finishes	38

MESA

CONFERENCE TABLES

Overview	40
Pricing	49
Finishes	50

TERMS & CONDITIONS	58
--------------------	----

LUNE

NESTING TABLES

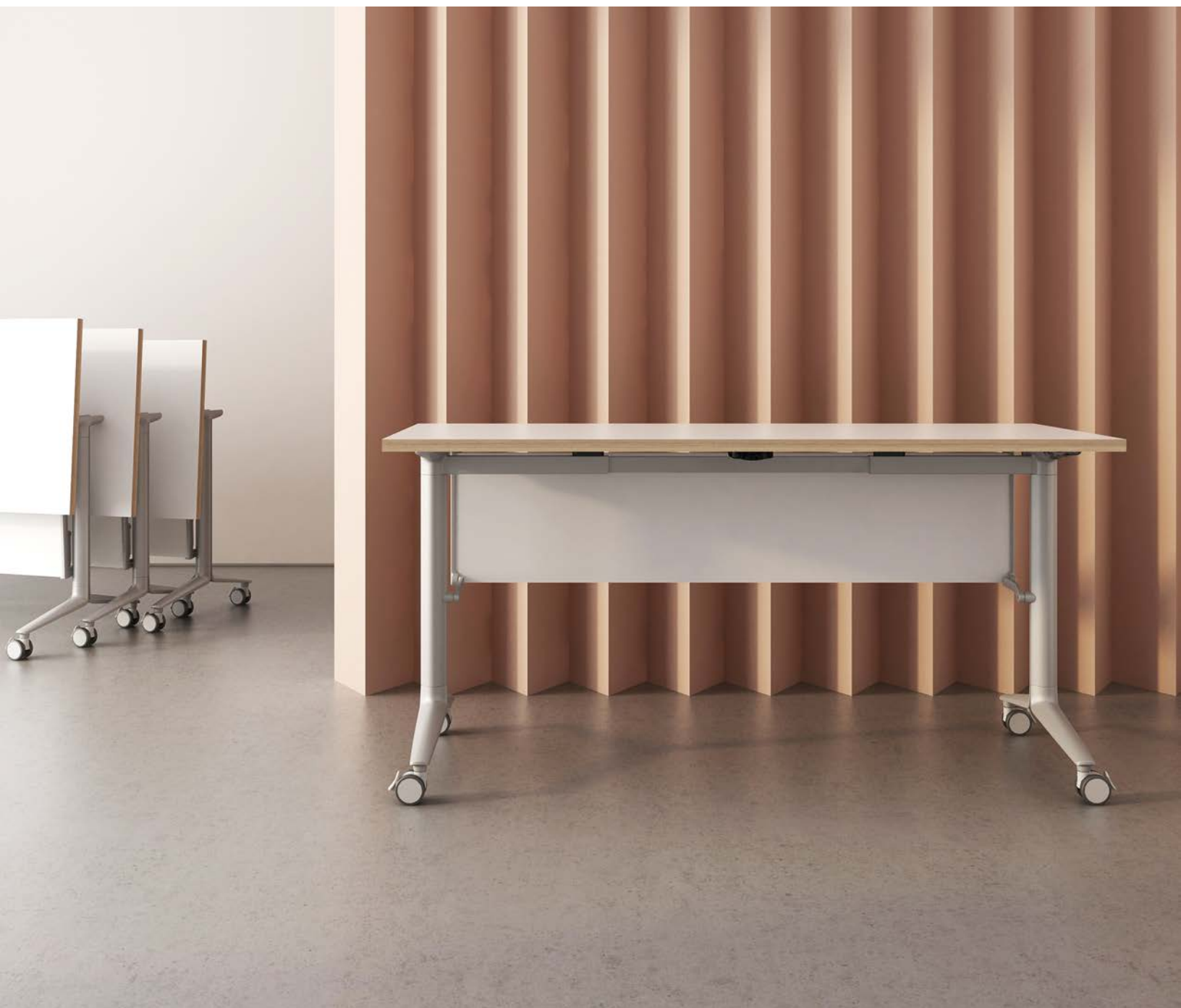

NESTING
TABLES
LUNE



FORM
FLEXIBILITY
FUNCTION

Versatile and mobile, Lune tables are easy to set-up and configure into a wide range of spaces. Rearrange and adapt on the fly. The flip-top mechanism enables you to make the most of your space, easily nesting tables for compact storage when not in use.

NESTING
TABLES
LUNE



Create dynamic spaces for people to learn, collaborate, and connect.

**LUNE and SOLEIL
THE PERFECT MATCH**

Soleil flip-up chairs on casters are the perfect accompaniment to Lune tables.

Find them in the Seating Catalog at friant.com

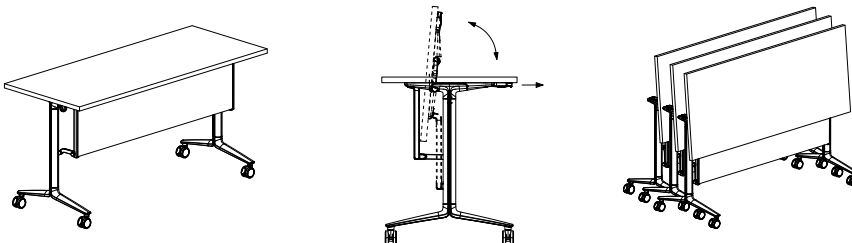

LUNE TABLE FEATURES AND FUNCTIONS

Easy to move, use and store.

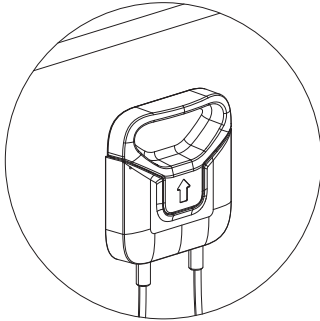

FLIP MECHANISM

Simple flip-top mechanism is designed for single-handed operation

OPTIONAL CONNECTING BRACKET

Link multiple tables together to adapt and reconfigure as needed

MODESTY PANEL

Available with and without modesty panel

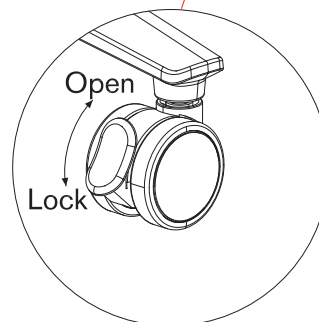
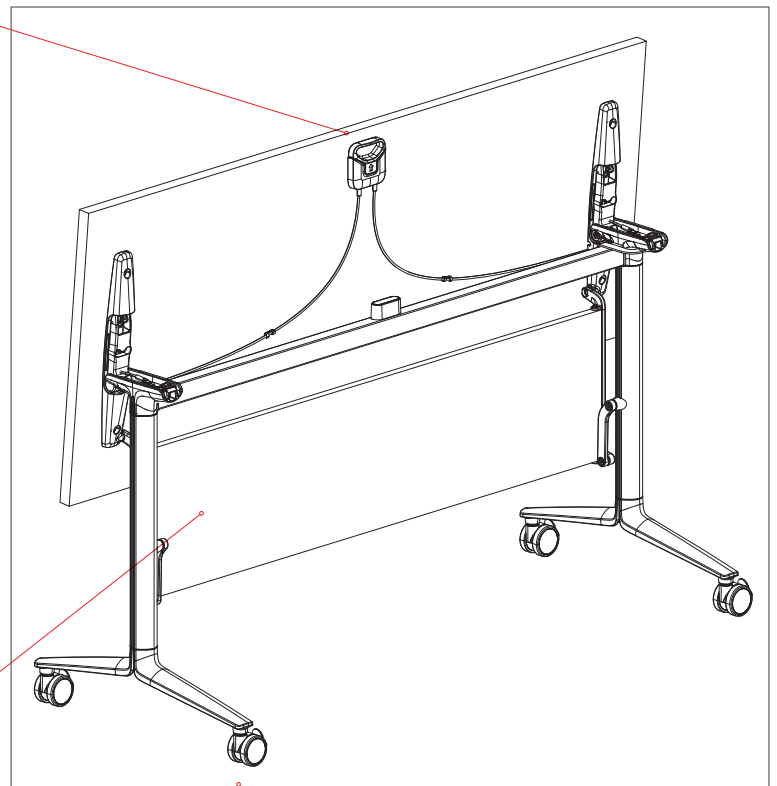

LOCKING CASTERS

Quickly and easily lock the table in place

ORDER LUNE IN 4 SIMPLE STEPS:

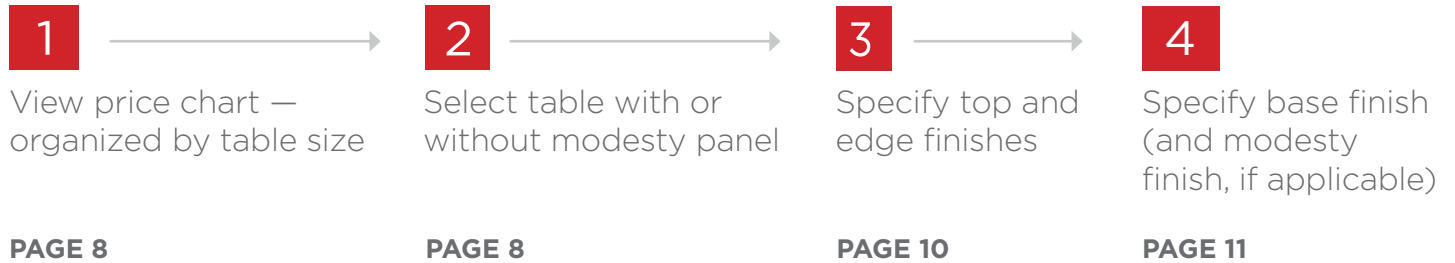

ANATOMY OF A PRODUCT NUMBER



Be sure to specify finishes and base options in the description of your order.

Example:

FCTTB-MOD.2460

Description:

Lune flip up nesting table on casters, with modesty panel, 24 x 60

Top Finish:	M13	Licorice
Edge Finish:	E13	Licorice
Finish:	GM	Gunmetal
Modesty Finish:	BU	Black Umber

LUNE TABLE WITHOUT MODESTY

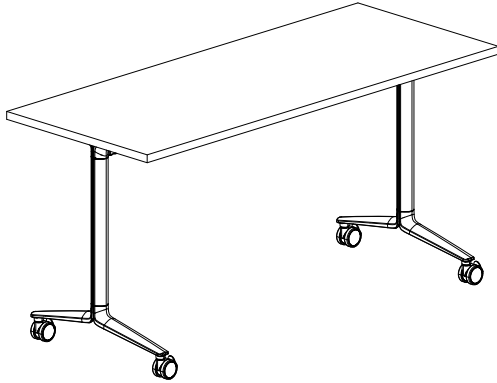

Model No.	Depth	Length	List
FCTTB.2048	20" Δ	48"	\$1,877
FCTTB.2054	20" Δ	54"	\$1,926
FCTTB.2060	20" Δ	60"	\$1,931
FCTTB.2072	20" Δ	72"	\$1,996
FCTTB.2448	24"	48"	\$1,915
FCTTB.2454	24"	54"	\$1,964
FCTTB.2460	24"	60"	\$1,970
FCTTB.2472	24"	72"	\$2,033
FCTTB.3048	30"	48"	\$1,926
FCTTB.3054	30"	54"	\$1,981
FCTTB.3060	30"	60"	\$1,986
FCTTB.3072	30"	72"	\$2,053

Δ The base is 22 $\frac{1}{4}$ "D and will extend past 20"D tops slightly.

LUNE TABLE WITH MODESTY

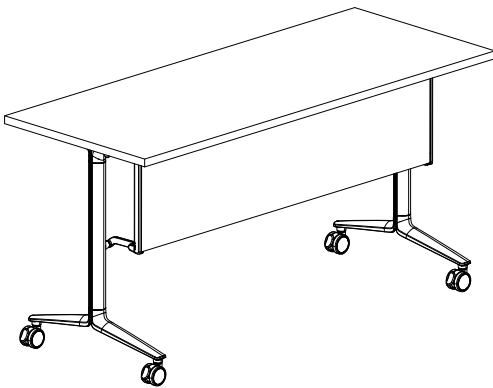

Model No.	Depth	Length	List
FCTTB-MOD.2048	20" Δ	48"	\$2,204
FCTTB-MOD.2054	20" Δ	54"	\$2,254
FCTTB-MOD.2060	20" Δ	60"	\$2,257
FCTTB-MOD.2072	20" Δ	72"	\$2,352
FCTTB-MOD.2448	24"	48"	\$2,244
FCTTB-MOD.2454	24"	54"	\$2,292
FCTTB-MOD.2460	24"	60"	\$2,295
FCTTB-MOD.2472	24"	72"	\$2,390
FCTTB-MOD.3048	30"	48"	\$2,254
FCTTB-MOD.3054	30"	54"	\$2,311
FCTTB-MOD.3060	30"	60"	\$2,316
FCTTB-MOD.3072	30"	72"	\$2,411

Δ The base is 22 $\frac{1}{4}$ "D and will extend past 20"D tops slightly.

CONNECTING BRACKET PAIR

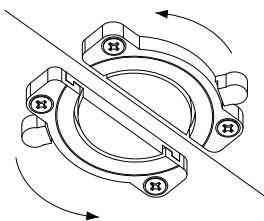

Model No.	Depth	Length	List
FCTTCB	-	-	\$47

DESK MOUNTED POWER UNIT



Model No.	Description	List	Notes
FPWR.DM	Clamp on Power Unit	\$468	<ul style="list-style-type: none"> The power cord comes attached to the unit. The cord measures approximately 6 ft in length Includes 3 plugs and 2 USB-A ports Distributes up to 10 amps Finish: available in BU and CW Clamp-on power unit may need to be moved or removed when nesting, contact Design (design@friant.com) to discuss specific application questions

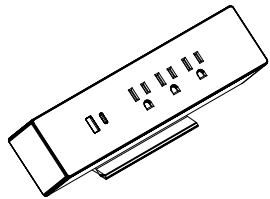

Model No.	Description	List	Notes
FPWR.DM-2	Adhesive Power Unit	\$468	<ul style="list-style-type: none"> The power cord comes attached to the unit. The cord measures approximately 6 ft in length Includes 3 plugs, 1 USB-C and 1 USB-A port Distributes up to 10 amps Finish: available in BU and CW

TABLE POWER DISTRIBUTION UNIT





Model No.	Description	List	Notes
FD-SFC-306-4A	Table Power Distribution Unit	\$102	<ul style="list-style-type: none"> Power strip to attaches to the underside of tabletops For use with single circuit infeed (FD-BPI.1CIR)







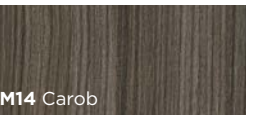
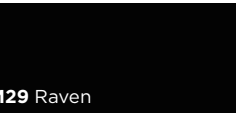
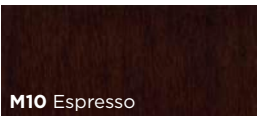
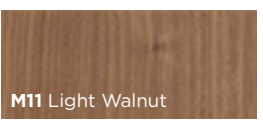
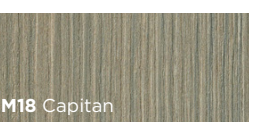





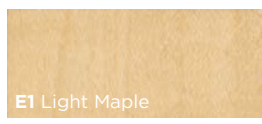

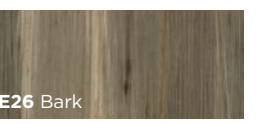

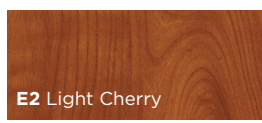
Model No.	Description	List	Notes
FD-BPI.1CIR	Single Circuit Infeed	\$117	<ul style="list-style-type: none"> Plug-in power infeed for use with table power distribution, 8' cord
FD-DCI.1CIR	Daisy Chain Power Connector	\$117	<ul style="list-style-type: none"> Connects adjacent table power units, 8' cord

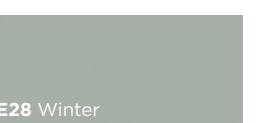
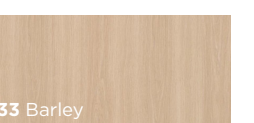
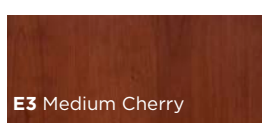
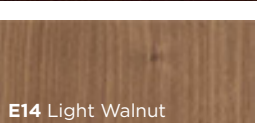
LUNE STANDARD FINISHES

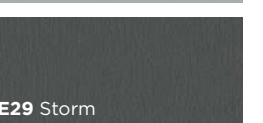
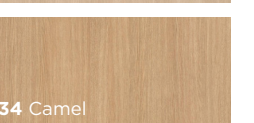
Top Finish

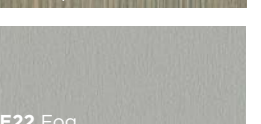
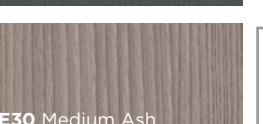
 M1 Light Maple	 M9 Cloud White	 M14 Carob	 M23 Bark	 M29 Raven
 M2 Light Cherry	 M10 Espresso	 M16 Tundra	 M25 Winter	 M30 Barley
 M3 Medium Cherry	 M11 Light Walnut	 M18 Capitan	 M26 Storm	 M31 Camel
 M4 Dark Mahogany	 M12 Medium Walnut	 M19 Fog	 M27 Medium Ash	
 M6 Light Gray	 M13 Licorice	 M20 Sandstone	 M28 Arctic	

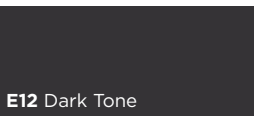
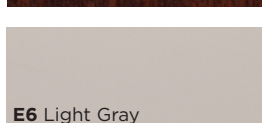
Edge Finish (PVC)

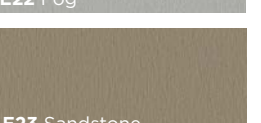
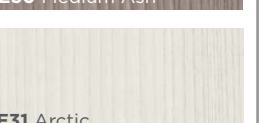
 E1 Light Maple	 E9 Cloud White	 E17 Carob	 E26 Bark	 E32 Raven
 E2 Light Cherry	 E10 Espresso	 E19 Tundra	 E28 Winter	 E33 Barley
 E3 Medium Cherry	 E14 Light Walnut	 E21 Capitan	 E29 Storm	 E34 Camel
 E4 Dark Mahogany	 E15 Medium Walnut	 E22 Fog	 E30 Medium Ash	<div data-bbox="1242 1596 1526 1900"> <p>Additional Edge Finishes</p>  E11 Medium Tone  E12 Dark Tone </div>
 E6 Light Gray	 E13 Licorice	 E23 Sandstone	 E31 Arctic	

LUNE STANDARD FINISHES

Finish

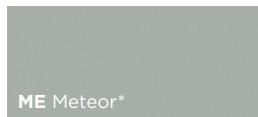
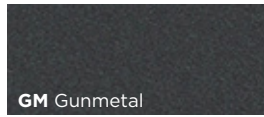

* Contact Customer Success for lead time

Modesty Finish

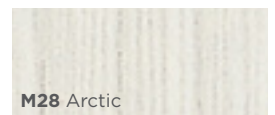
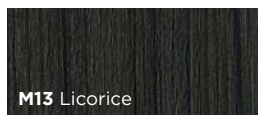
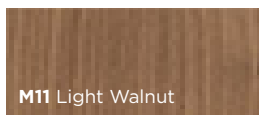
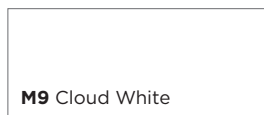

SCOPE

OCCASIONAL TABLES





FIND THE PERFECT FIT

With four heights and a wide range of shapes and sizes, these tables are ready to be where you need to be. Paired with Friant's range of stools and soft seating, it's easy to create a lounge area, meeting space, cafe space, and more.

OCCASIONAL
TABLES
SCOPE



Create spaces beyond the workstation that can foster connectivity or focus



SCOPE OCCASIONAL TABLE FEATURES

Ready to be where you want to be

SIZES AND SHAPES

Surface shapes and sizes to fit your needs, whether you're feeling square or thinking outside the box.

COLUMN HEIGHTS

Tubular steel column is offered in four different height options: lounge, table, counter, and bar

DISC BASE

Low profile weighted base for stability



THE COMPLETE PACKAGE

Friant offers stools and chairs in complementary heights to complete your space. See the options in our Seating Catalog at friant.com

SPECIFYING
OCCASIONAL
SCOPE

ORDERING IS EASY! 3 SIMPLE STEPS:

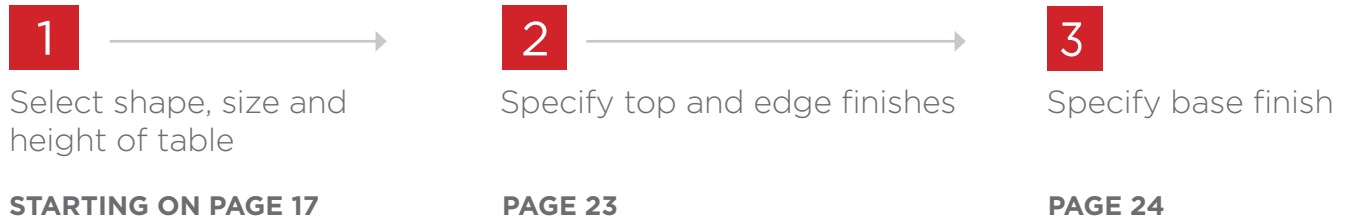

ANATOMY OF A PRODUCT NUMBER

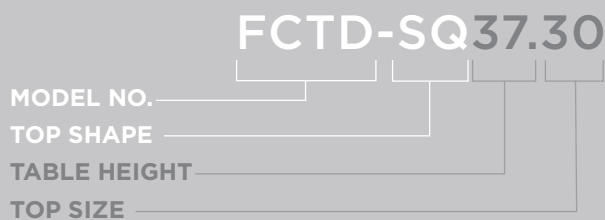

Be sure to specify finishes and base options in the description of your order.

Example:

FCTD-SQ37.30

Description:

Disc Base Table, 37”H, 30” Square Top

Top Finish:	M13	Licorice
Edge Finish:	E13	Licorice
Base Finish:	MB	Matte Black

LOUNGE HEIGHT, 19”H

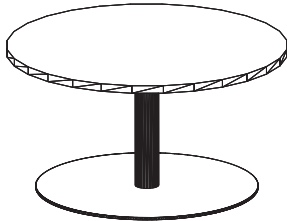

ROUND

Model No.	Top Size	List	
		Matte Black Base	Metal Base
FCTD-RD19.24	24"	\$1,292	\$1,482
FCTD-RD19.30	30"	\$1,693	\$1,883
FCTD-RD19.36	36"	\$2,043	\$2,233
FCTD-RD19.42	42"	\$2,049	\$2,239

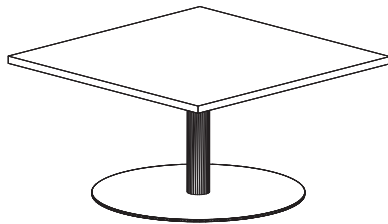

SQUARE

Model No.	Top Size	List	
		Matte Black Base	Metal Base
FCTD-SQ19.24	24"	\$1,245	\$1,435
FCTD-SQ19.30	30"	\$1,669	\$1,859
FCTD-SQ19.36	36"	\$1,999	\$2,189
FCTD-SQ19.42	42"	\$2,006	\$2,196

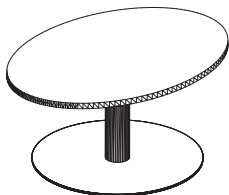

OVAL

SINGLE DISC BASE

Model No.	Top Size	List	
		Matte Black Base	Metal Base
FCTD-OV19.3042	30"x42"	\$1,813	\$2,003
FCTD-OV19.3048	30"x48"	\$1,817	\$2,007

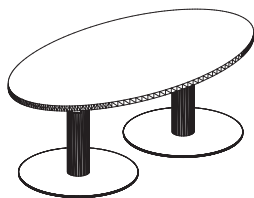

TWO DISC BASE

Model No.	Top Size	List	
		Matte Black Base	Metal Base
FCTD-OV19.3054	30"x54"	\$2,019	\$2,460
FCTD-OV19.3060	30"x60"	\$2,024	\$2,465

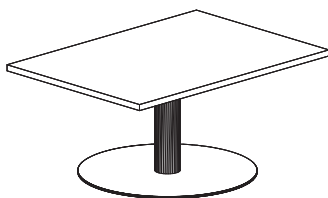

RECTANGULAR

SINGLE DISC BASE

Model No.	Top Size	List	
		Matte Black Base	Metal Base
FCTD-RT19.3042	30"x42"	\$1,727	\$1,917
FCTD-RT19.3048	30"x48"	\$1,732	\$1,922

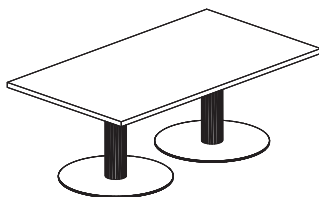

TWO DISC BASE

Model No.	Top Size	List	
		Matte Black Base	Metal Base
FCTD-RT19.3054	30"x54"	\$2,038	\$2,418
FCTD-RT19.3060	30"x60"	\$2,042	\$2,422

TABLE HEIGHT, 29"H

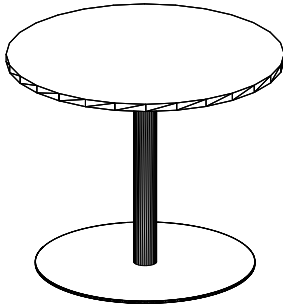

ROUND

Model No.	Top Size	List	
		Matte Black Base	Metal Base
FCTD-RD29.24	24"	\$1,303	\$1,493
FCTD-RD29.30	30"	\$1,703	\$1,893
FCTD-RD29.36	36"	\$2,054	\$2,244
FCTD-RD29.42	42"	\$2,097	\$2,287

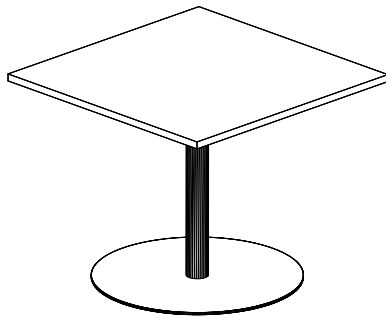

SQUARE

Model No.	Top Size	List	
		Matte Black Base	Metal Base
FCTD-SQ29.24	24"	\$1,256	\$1,446
FCTD-SQ29.30	30"	\$1,679	\$1,869
FCTD-SQ29.36	36"	\$2,010	\$2,200
FCTD-SQ29.42	42"	\$2,054	\$2,244

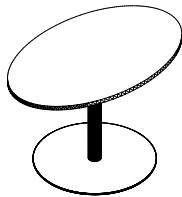

OVAL

SINGLE DISC BASE

Model No.	Top Size	List	
		Matte Black Base	Metal Base
FCTD-OV29.3048	30"x48"	\$1,837	\$2,027

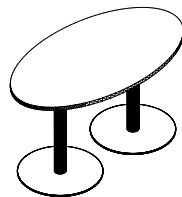

TWO DISC BASE

Model No.	Top Size	List	
		Matte Black Base	Metal Base
FCTD-OV29.3054	30"x54"	\$2,087	\$2,467
FCTD-OV29.3060	30"x60"	\$2,092	\$2,472

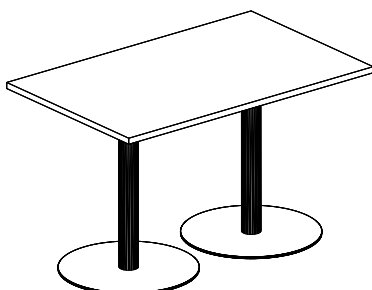

RECTANGULAR

TWO DISC BASE

Model No.	Top Size	List	
		Matte Black Base	Metal Base
FCTD-RT29.3048	30"x48"	\$1,933	\$2,313
FCTD-RT29.3054	30"x54"	\$2,044	\$2,424
FCTD-RT29.3060	30"x60"	\$2,050	\$2,430

COUNTER HEIGHT, 37”H

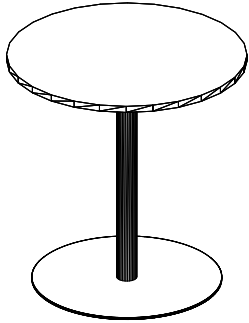

ROUND

Model No.	Top Size	List	
		Matte Black Base	Metal Base
FCTD-RD37.24	24"	\$1,334	\$1,524
FCTD-RD37.30	30"	\$1,734	\$1,924
FCTD-RD37.36	36"	\$2,086	\$2,276

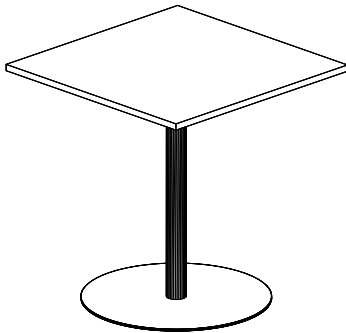

SQUARE

Model No.	Top Size	List	
		Matte Black Base	Metal Base
FCTD-SQ37.24	24"	\$1,287	\$1,477
FCTD-SQ37.30	30"	\$1,710	\$1,900
FCTD-SQ37.36	36"	\$2,042	\$2,232

BAR HEIGHT, 42”H

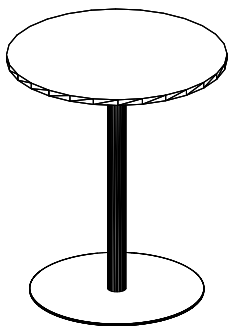

ROUND

Model No.	Top Size	List	
		Matte Black Base	Metal Base
FCTD-RD42.24	24"	\$1,344	\$1,534
FCTD-RD42.30	30"	\$1,743	\$1,933
FCTD-RD42.36	36"	\$2,093	\$2,283

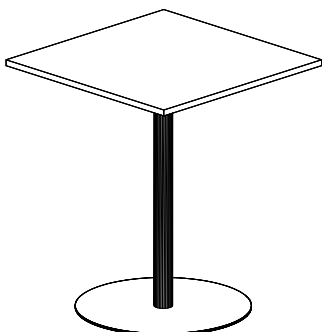

SQUARE

Model No.	Top Size	List	
		Matte Black Base	Metal Base
FCTD-SQ42.24	24"	\$1,296	\$1,486
FCTD-SQ42.30	30"	\$1,720	\$1,910
FCTD-SQ42.36	36"	\$2,050	\$2,240

TOP ONLY

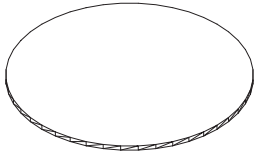

ROUND

Model No.	Top Size	List
FCD.24	24"	\$398
FCD.30	30"	\$478
FCD.36	36"	\$638
FCD.42	42"	\$753

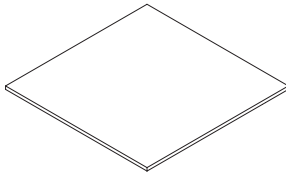

SQUARE

Model No.	Top Size	List
FCSQ.24	24"	\$308
FCSQ.30	30"	\$342
FCSQ.36	36"	\$455
FCSQ.42	42"	\$595

BASE ONLY

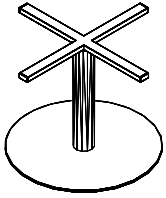

LOUNGE HEIGHT 19”H

3” DIA. POST

Model No.	Top Plate	Disc Size	List	
			Matte Black Base	Metal Base
FCTD-192123.3	23”	21”	\$936	\$1,126
FCTD-192823.3	23”	28”	\$1,378	\$1,568
FCTD-192831.3	31”	28”	\$1,406	\$1,596

Notes

See Application Guide on page 22

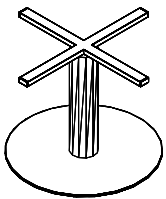

4” DIA. POST

Model No.	Top Plate	Disc Size	List	
			Matte Black Base	Metal Base
FCTD-192123.4	23”	21”	\$982	\$1,172
FCTD-192831.4	31”	28”	\$1,453	\$1,643

Notes

See Application Guide on page 22

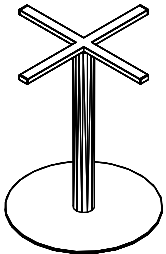

TABLE HEIGHT 29”H

3” DIA. POST

Model No.	Top Plate	Disc Size	List	
			Matte Black Base	Metal Base
FCTD-292123	23”	21”	\$950	\$1,140
FCTD-292823	23”	28”	\$1,392	\$1,582
FCTD-292831	31”	28”	\$1,420	\$1,610

Notes

See Application Guide on page 22

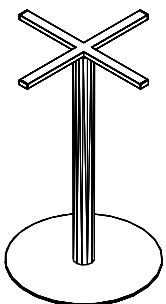

4” DIA. POST

Model No.	Top Plate	Disc Size	List	
			Matte Black Base	Metal Base
FCTD-292831.4	31”	28”	\$1,435	\$1,625

Notes

See Application Guide on page 22

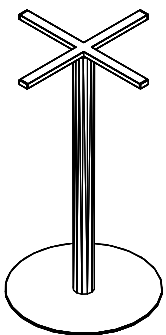

COUNTER HEIGHT 37”H

Model No.	Top Plate	Disc Size	List	
			Matte Black Base	Metal Base
FCTD-372123	23”	21”	\$988	\$1,178
FCTD-372823	23”	28”	\$1,431	\$1,621
FCTD-372831	31”	28”	\$1,459	\$1,649

Notes

See Application Guide on page 22

BAR HEIGHT 42”H

Model No.	Top Plate	Disc Size	List	
			Matte Black Base	Metal Base
FCTD-422123	23”	21”	\$1,000	\$1,190
FCTD-422823	23”	28”	\$1,441	\$1,631
FCTD-422831	31”	28”	\$1,470	\$1,660

Notes

See Application Guide on page 22











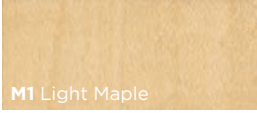

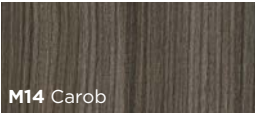
BASE ONLY APPLICATION GUIDE

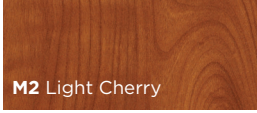
See chart below to identify what type of base is needed for each top size.
Please note, some sizes of Rectangle and Oval tops will need two bases.

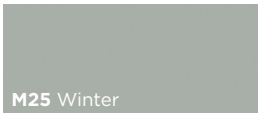
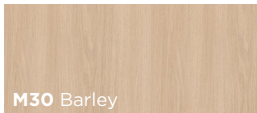
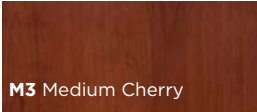
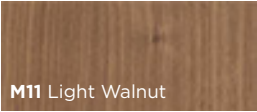
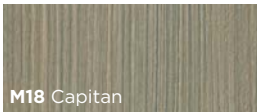
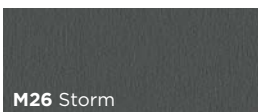
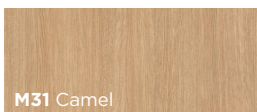
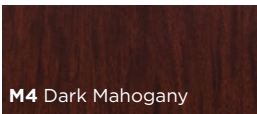
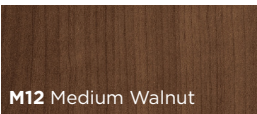

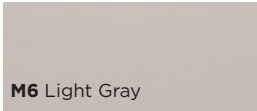

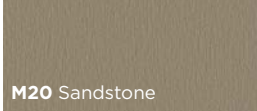







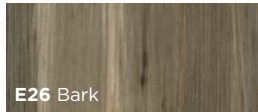

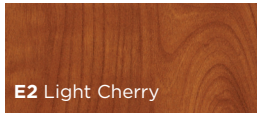
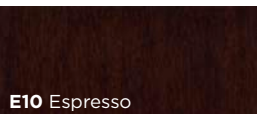
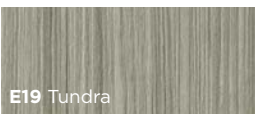

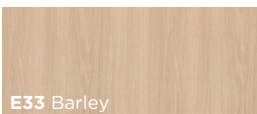
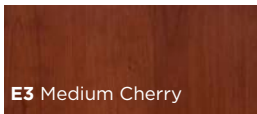
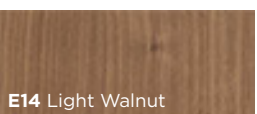
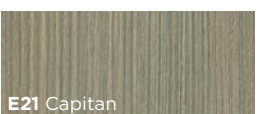
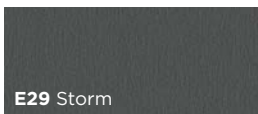
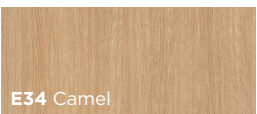
TOP SHAPE	TOP SIZE	19"H LOUNGE HEIGHT	29"H TABLE HEIGHT	37"H COUNTER HEIGHT	42"H BAR HEIGHT
ROUND	24"	FCTD-192123.3	FCTD-292123	FCTD-372123	FCTD-422123
	30"	FCTD-192823.3	FCTD-292823	FCTD-372823	FCTD-422823
	36"	FCTD-192831.3	FCTD-292831	FCTD-372831	FCTD-422831
	42"	FCTD-192831.4	FCTD-292831.4		
SQUARE	24"	FCTD-192123.3	FCTD-292123	FCTD-372123	FCTD-422123
	30"	FCTD-192831.3	FCTD-292831	FCTD-372831	FCTD-422831
	36"	FCTD-192831.3	FCTD-292831	FCTD-372831	FCTD-422831
	42"	FCTD-192831.4	FCTD-292831.4		
RECTANGLE	24" x 54"	(2) FCTD-192123.4	(2) FCTD-292123	(2) FCTD-372123	(2) FCTD-422123
	24" x 60"	(2) FCTD-192123.4	(2) FCTD-292123	(2) FCTD-372123	(2) FCTD-422123
	24" x 66"	(2) FCTD-192123.4	(2) FCTD-292123	(2) FCTD-372123	(2) FCTD-422123
	24" x 72"	(2) FCTD-192123.4	(2) FCTD-292123	(2) FCTD-372123	(2) FCTD-422123
	30" x 42"	FCTD-192831.4			
	30" x 48"	FCTD-192831.4	(2) FCTD-292123	(2) FCTD-372123	(2) FCTD-422123
	30" x 54"	(2) FCTD-192123.4	(2) FCTD-292123	(2) FCTD-372123	(2) FCTD-422123
	30" x 60"	(2) FCTD-192123.4	(2) FCTD-292123	(2) FCTD-372123	(2) FCTD-422123
	30" x 66"	(2) FCTD-192831.4	(2) FCTD-292831	(2) FCTD-372831	(2) FCTD-422831
	30" x 72"	(2) FCTD-192831.4	(2) FCTD-292123	(2) FCTD-372831	(2) FCTD-422831
	30" x 78"	(2) FCTD-192831.4			
	30" x 84"	(2) FCTD-192831.4			
	36" x 66"	(2) FCTD-192831.4	(2) FCTD-292831		
	36" x 72"	(2) FCTD-192831.4	(2) FCTD-292831		
	36" x 78"	(2) FCTD-192831.4	(2) FCTD-292831		
	36" x 84"	(2) FCTD-192831.4	(2) FCTD-292831		
OVAL	30" x 42"	FCTD-192831.4			
	30" x 48"	FCTD-192831.4			
	30" x 54"	(2) FCTD-192123.4	(2) FCTD-292123		
	30" x 60"	(2) FCTD-192123.4	(2) FCTD-292123		

SCOPE STANDARD FINISHES

Top Finish

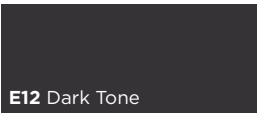
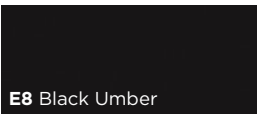
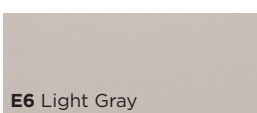
 M1 Light Maple	 M9 Cloud White	 M14 Carob	 M23 Bark	 M29 Raven
 M2 Light Cherry	 M10 Espresso	 M16 Tundra	 M25 Winter	 M30 Barley
 M3 Medium Cherry	 M11 Light Walnut	 M18 Capitan	 M26 Storm	 M31 Camel
 M4 Dark Mahogany	 M12 Medium Walnut	 M19 Fog	 M27 Medium Ash	
 M6 Light Gray	 M13 Licorice	 M20 Sandstone	 M28 Arctic	

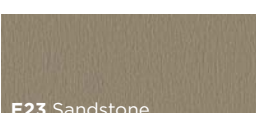
Edge Finish (PVC)

 E1 Light Maple	 E9 Cloud White	 E17 Carob	 E26 Bark	 E32 Raven
 E2 Light Cherry	 E10 Espresso	 E19 Tundra	 E28 Winter	 E33 Barley
 E3 Medium Cherry	 E14 Light Walnut	 E21 Capitan	 E29 Storm	 E34 Camel
 E4 Dark Mahogany	 E15 Medium Walnut	 E22 Fog	 E30 Medium Ash	<div data-bbox="1263 1497 1518 1923"> <p>Additional Edge Finishes</p>  E11 Medium Tone  E12 Dark Tone  E8 Black Umber </div>
 E6 Light Gray	 E13 Licorice	 E23 Sandstone	 E31 Arctic	

SCOPE STANDARD FINISHES

Base Finish

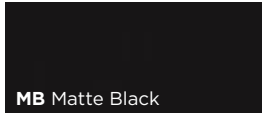

ROKE & RAFFE

TABLES



Tables

**ROKE AND
RAFFE**

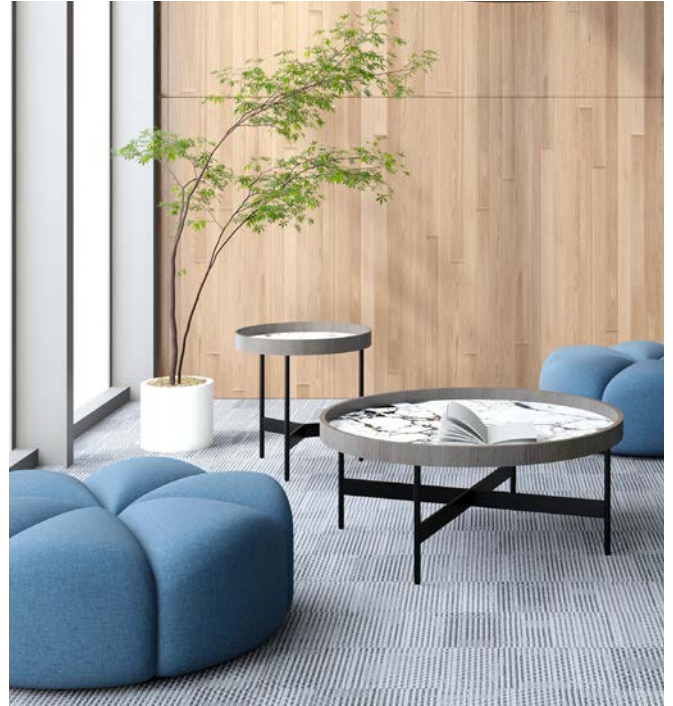

ROKE TABLES

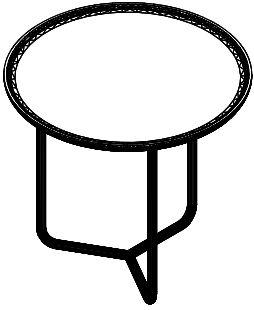

ROKE SIDE TABLE

Model No.	Top Size	Height	List
F452B	22"	20"	\$1,758

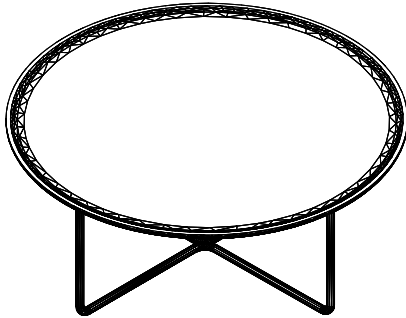

ROKE COFFEE TABLE

Model No.	Top Size	Height	List
F452E	40"	15"	\$3,204

RAFFE TABLES

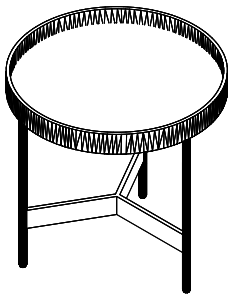

RAFFE SIDE TABLE

Model No.	Top Size	Height	List
F441B	20"	20"	\$1,758

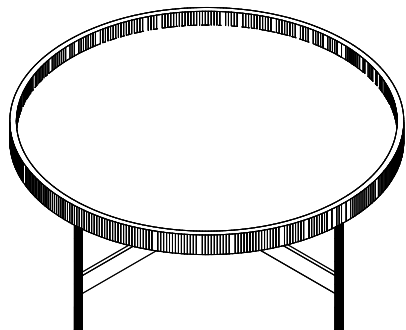

RAFFE COFFEE TABLE

Model No.	Top Size	Height	List
F441E	36"	15"	\$3,272

ROKE AND RAFFE STANDARD FINISHES

Roke Top Finish



Roke Base Finish

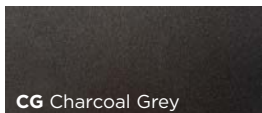

Raffe Top Finish

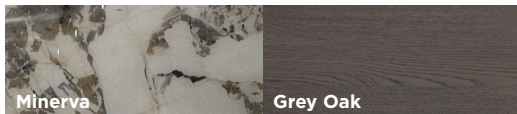

Raffe Base Finish

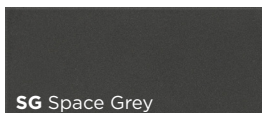

METAL BASE

TABLES



SPECIFYING
METAL BASE
TABLES

ORDERING IS EASY! 3 SIMPLE STEPS:

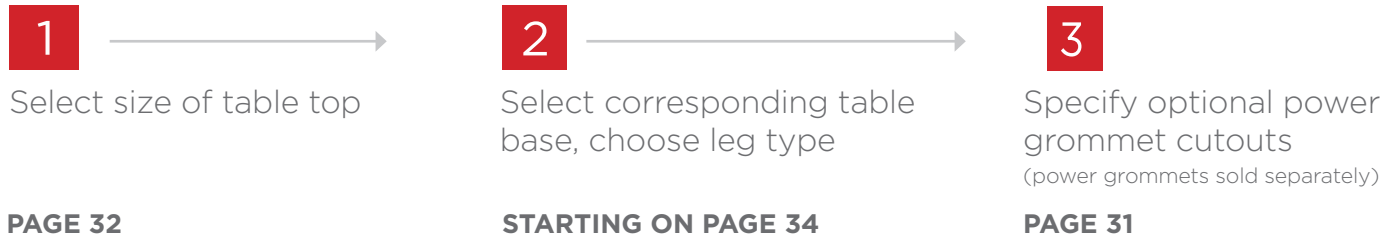

ANATOMY OF A PRODUCT NUMBER

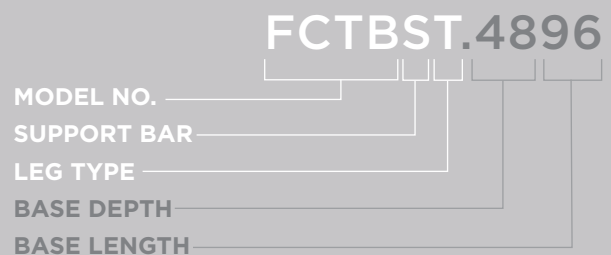
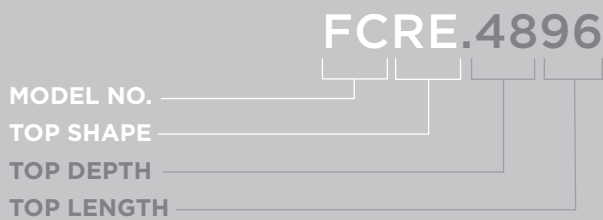

Be sure to specify finishes and base options in the description of your order.

Example:

FCRE.4896

Description:

Rectangular Conference Table Top, 48" x 96"

Top Finish: FB3920 Licorice Groovz

Edge Finish: E13 Licorice

Grommet Location: PG6C Grommet cutout

Example:

FCTBST.4896

Description:

Conference Table Base, Stright Taper, 48" x 96"

Finish: CW Cloud White

POWER GROMMET CUTOUT LOCATIONS

Factory cutouts for power grommets are available in 5x8 or 6x8 for use with Friant power grommets.

When selected, factory cutout option includes (1) cutout for tops up to 90"W, (2) cutouts for tops 96"W and up.

Order power grommets separately.

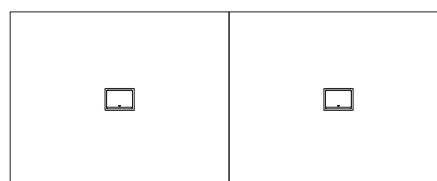
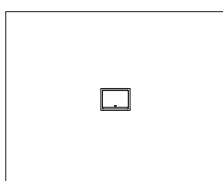

TABLE TOPS 48"W - 90"W

TABLE TOPS 96"W - 144"W

Code	Position	List Upcharge
PG5C	One cutout, for 5x8 power grommet. Centered on table top	\$75
PG6C	One cutout, for 6x8 power grommet. Centered on table top	\$75

Code	Position	List Upcharge
2-PG5C	Two cutouts for 5x8 power grommets, centered on each side	\$150
2-PG6C	Two cutouts for 6x8 power grommets, centered on each side"	\$150



RECTANGULAR TOP - 48"D

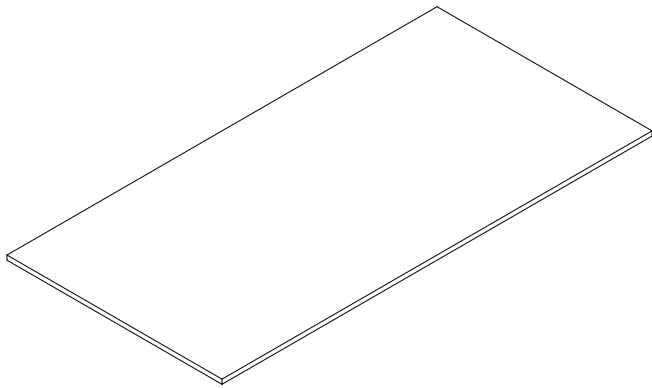

Model No.	Depth	Length	List
FCRE.4860	48"	60"	\$2,676
FCRE.4866	48"	66"	\$2,683
FCRE.4872	48"	72"	\$2,690
FCRE.4878	48"	78"	\$2,696
FCRE.4884	48"	84"	\$2,703
FCRE.4890	48"	90"	\$2,709
FCRE.4896	48"	96"	\$2,823
FCRE.48108	48"	108"	\$5,394
FCRE.48120	48"	120"	\$5,407
FCRE.48132	48"	132"	\$5,421
FCRE.48144	48"	144"	\$5,435
FCRE.48156	48"	156"	\$5,449

Tops 90" and under are one piece, tops 96" and over are two pieces

RECTANGULAR TOP - 60"D

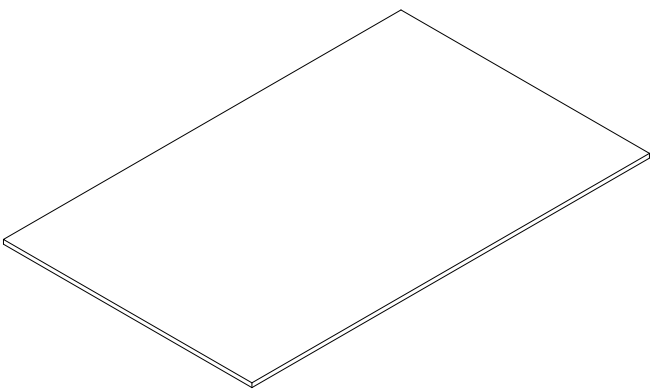

Model No.	Depth	Length	List
FCRE.6060	60"	60"	\$3,327
FCRE.6066	60"	66"	\$3,335
FCRE.6072	60"	72"	\$3,341
FCRE.6078	60"	78"	\$3,348
FCRE.6084	60"	84"	\$3,355
FCRE.6090	60"	90"	\$3,362
FCRE.6096	60"	96"	\$3,500
FCRE.60108	60"	108"	\$6,710
FCRE.60120	60"	120"	\$6,724
FCRE.60132	60"	132"	\$6,738
FCRE.60144	60"	144"	\$6,752
FCRE.60156	60"	156"	\$6,767

Tops 90" and under are one piece, tops 96" and over are two pieces

POWER GROMMET, 5X8

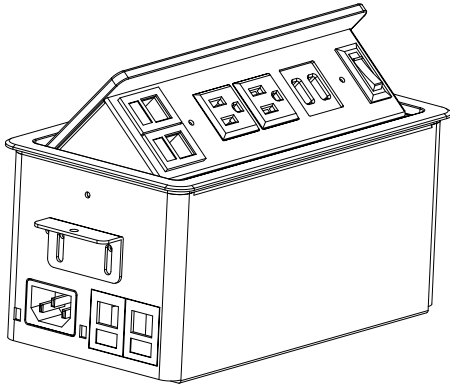

Model No.	Width	Depth	List
FPWR.0508	8"	5"	\$784

- WORKSURFACE MOUNTED POWER/DATA GROMMET, 5X8
- Includes 10' coiled power cord to connect to power source
 - Distributes up to 10 amps
 - **Above Worksurface:** (2) CAT6 data ports (out), (2) power outlets, (2) USB ports
 - **Below Worksurface:** (2) CAT6 data ports (in), (1) power outlet, Daisy Chain ports (in/out)
 - Finish Options: BA Brushed Aluminum, BC Brushed Charcoal or CW Cloud White (contact Customer Success for lead time)

POWER GROMMET, 6X8

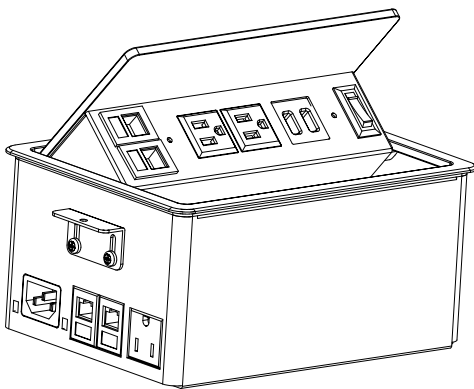

Model No.	Width	Depth	List
FPWR.0608	8"	6"	\$784

- WORKSURFACE MOUNTED POWER/DATA GROMMET, 6X8
- Includes 10' coiled power cord to connect to power source
 - Distributes up to 10 amps
 - **Above Worksurface:** (2) CAT6 data ports (out), (2) power outlets, (2) USB ports
 - **Below Worksurface:** (2) CAT6 data ports (in), (2) power outlets, Daisy Chain ports (in/out)
 - Finish Options: BA Brushed Aluminum, BC Brushed Charcoal or CW Cloud White (contact Customer Success for lead time)

STRAIGHT INSET BASE - 48"D

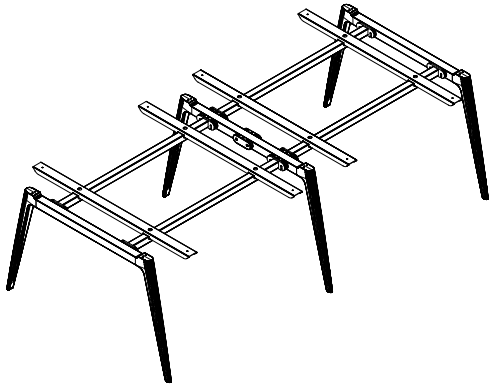

Model No.	Depth	Length	List
FCTBSI.4860	48"	60"	\$2,099
FCTBSI.4866	48"	66"	\$2,120
FCTBSI.4872	48"	72"	\$2,145
FCTBSI.4878	48"	78"	\$2,170
FCTBSI.4884	48"	84"	\$2,192
FCTBSI.4896	48"	96"	\$3,271
FCTBSI.48108	48"	108"	\$3,285
FCTBSI.48120	48"	120"	\$3,376
FCTBSI.48132	48"	132"	\$3,420
FCTBSI.48144	48"	144"	\$3,471

STRAIGHT INSET BASE - 60"D

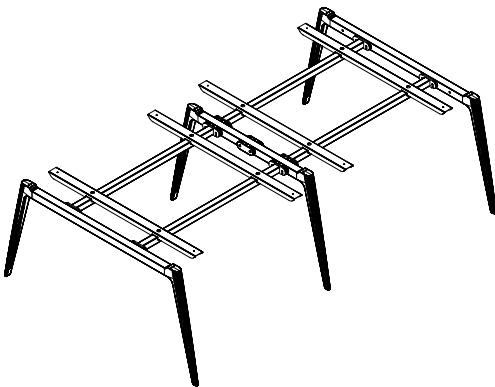

Model No.	Depth	Length	List
FCTBSI.6060	60"	60"	\$2,131
FCTBSI.6066	60"	66"	\$2,152
FCTBSI.6072	60"	72"	\$2,177
FCTBSI.6078	60"	78"	\$2,202
FCTBSI.6084	60"	84"	\$2,224
FCTBSI.6096	60"	96"	\$3,304
FCTBSI.60108	60"	108"	\$3,317
FCTBSI.60120	60"	120"	\$3,408
FCTBSI.60132	60"	132"	\$3,452
FCTBSI.60144	60"	144"	\$3,502

CONCAVE INSET BASE - 48"D

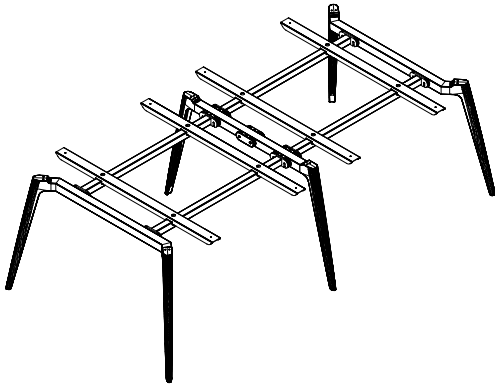

Model No.	Depth	Length	List
FCTBCI.4860	48"	60"	\$2,027
FCTBCI.4866	48"	66"	\$2,033
FCTBCI.4872	48"	72"	\$2,079
FCTBCI.4878	48"	78"	\$2,100
FCTBCI.4884	48"	84"	\$2,125
FCTBCI.4896	48"	96"	\$3,242
FCTBCI.48108	48"	108"	\$3,250
FCTBCI.48120	48"	120"	\$3,265
FCTBCI.48132	48"	132"	\$3,356
FCTBCI.48144	48"	144"	\$3,401

CONCAVE INSET BASE - 60"D

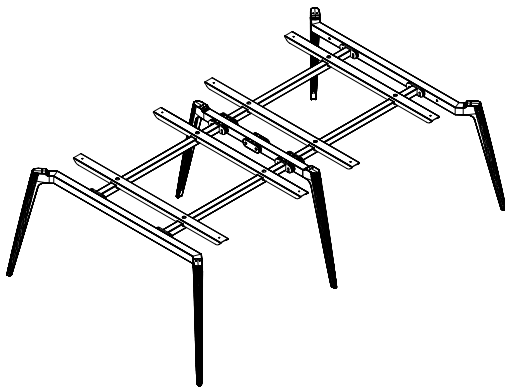

Model No.	Depth	Length	List
FCTBCI.6060	60"	60"	\$2,074
FCTBCI.6066	60"	66"	\$2,080
FCTBCI.6072	60"	72"	\$2,126
FCTBCI.6078	60"	78"	\$2,148
FCTBCI.6084	60"	84"	\$2,174
FCTBCI.6096	60"	96"	\$3,290
FCTBCI.60108	60"	108"	\$3,300
FCTBCI.60120	60"	120"	\$3,312
FCTBCI.60132	60"	132"	\$3,405
FCTBCI.60144	60"	144"	\$3,449

STRAIGHT TAPER BASE - 48"D

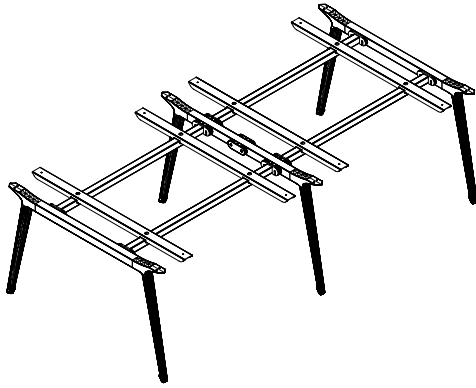

Model No.	Depth	Length	List
FCTBST.4860	48"	60"	\$2,288
FCTBST.4866	48"	66"	\$2,310
FCTBST.4872	48"	72"	\$2,334
FCTBST.4878	48"	78"	\$2,359
FCTBST.4884	48"	84"	\$2,382
FCTBST.4896	48"	96"	\$3,555
FCTBST.48108	48"	108"	\$3,569
FCTBST.48120	48"	120"	\$3,660
FCTBST.48132	48"	132"	\$3,704
FCTBST.48144	48"	144"	\$3,755

STRAIGHT TAPER BASE - 60"D

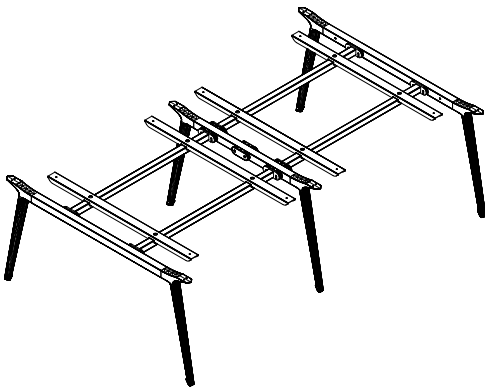

Model No.	Depth	Length	List
FCTBST.6060	60"	60"	\$2,320
FCTBST.6066	60"	66"	\$2,342
FCTBST.6072	60"	72"	\$2,366
FCTBST.6078	60"	78"	\$2,391
FCTBST.6084	60"	84"	\$2,414
FCTBST.6096	60"	96"	\$3,587
FCTBST.60108	60"	108"	\$3,601
FCTBST.60120	60"	120"	\$3,693
FCTBST.60132	60"	132"	\$3,736
FCTBST.60144	60"	144"	\$3,784

CONCAVE TAPER BASE - 48"D

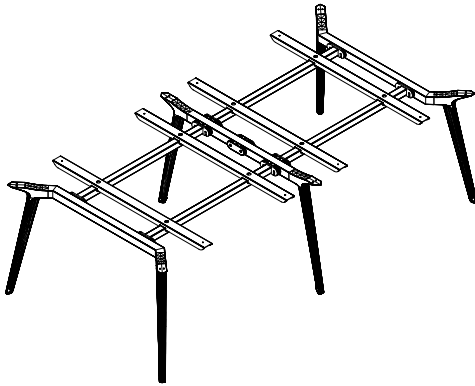

Model No.	Depth	Length	List
FCTBCT.4860	48"	60"	\$2,215
FCTBCT.4866	48"	66"	\$2,222
FCTBCT.4872	48"	72"	\$2,268
FCTBCT.4878	48"	78"	\$2,289
FCTBCT.4884	48"	84"	\$2,315
FCTBCT.4896	48"	96"	\$3,526
FCTBCT.48108	48"	108"	\$3,534
FCTBCT.48120	48"	120"	\$3,549
FCTBCT.48132	48"	132"	\$3,641
FCTBCT.48144	48"	144"	\$3,685



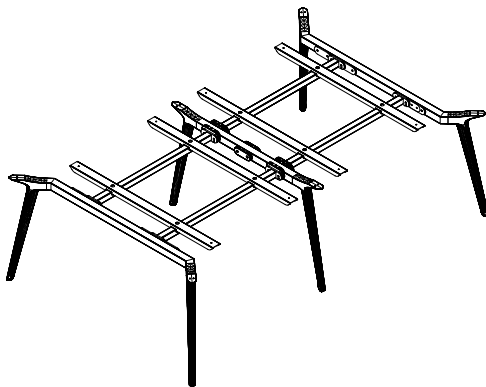

CONCAVE TAPER BASE - 60"D







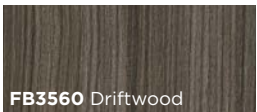
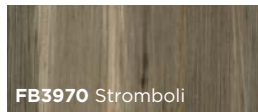
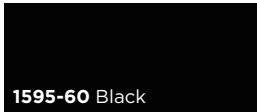
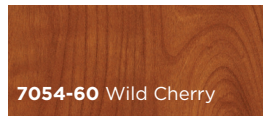
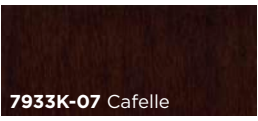
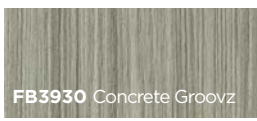

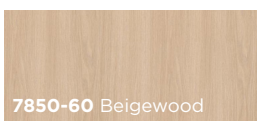
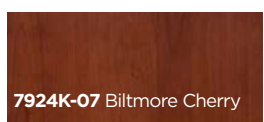
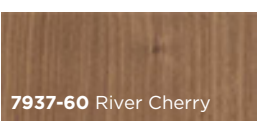
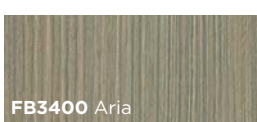
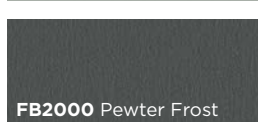
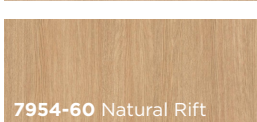
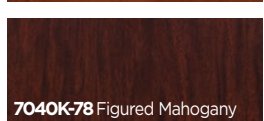
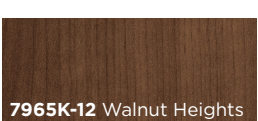
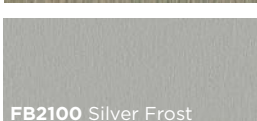
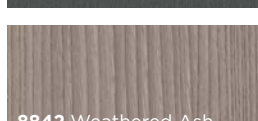
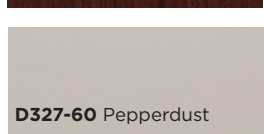
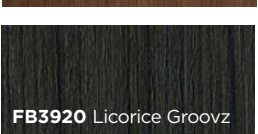
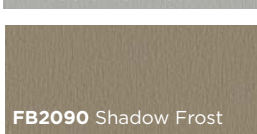
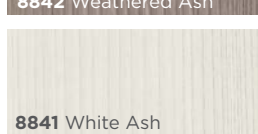



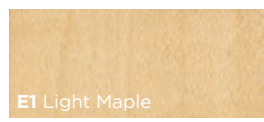

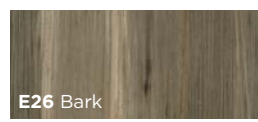
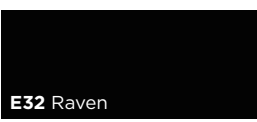
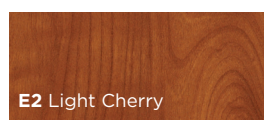
Model No.	Depth	Length	List
FCTBCT.6060	60"	60"	\$2,263
FCTBCT.6066	60"	66"	\$2,270
FCTBCT.6072	60"	72"	\$2,316
FCTBCT.6078	60"	78"	\$2,338
FCTBCT.6084	60"	84"	\$2,363
FCTBCT.6096	60"	96"	\$3,575
FCTBCT.60108	60"	108"	\$3,584
FCTBCT.60120	60"	120"	\$3,596
FCTBCT.60132	60"	132"	\$3,689
FCTBCT.60144	60"	144"	\$3,733

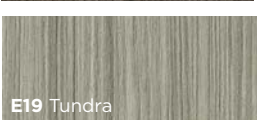
METAL BASE TABLE STANDARD FINISHES - TOPS

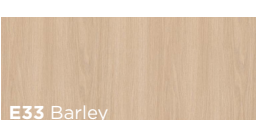
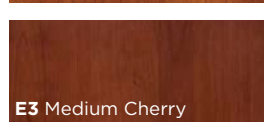
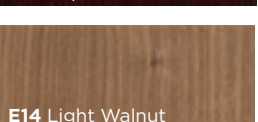
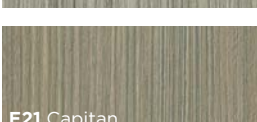
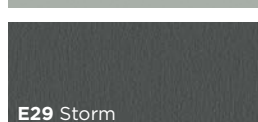
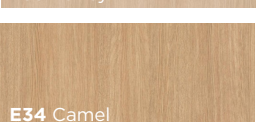
Top Finish

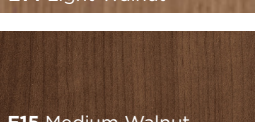
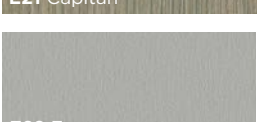
 7909-60 Fusion Maple	 1573-60 Frosty White	 FB3560 Driftwood	 FB3970 Stromboli	 1595-60 Black
 7054-60 Wild Cherry	 7933K-07 Cafelle	 FB3930 Concrete Groovz	 FB2130 Fog Grey	 7850-60 Beigewood
 7924K-07 Biltmore Cherry	 7937-60 River Cherry	 FB3400 Aria	 FB2000 Pewter Frost	 7954-60 Natural Rift
 7040K-78 Figured Mahogany	 7965K-12 Walnut Heights	 FB2100 Silver Frost	 8842 Weathered Ash	
 D327-60 Pepperdust	 FB3920 Licorice Groovz	 FB2090 Shadow Frost	 8841 White Ash	

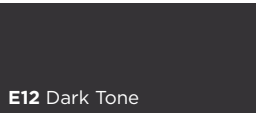
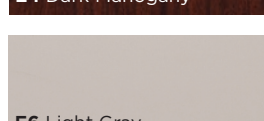
Edge Finish (PVC)

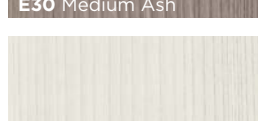
 E1 Light Maple	 E9 Cloud White	 E17 Carob	 E26 Bark	 E32 Raven
 E2 Light Cherry	 E10 Espresso	 E19 Tundra	 E28 Winter	 E33 Barley
 E3 Medium Cherry	 E14 Light Walnut	 E21 Capitan	 E29 Storm	 E34 Camel
 E4 Dark Mahogany	 E15 Medium Walnut	 E22 Fog	 E30 Medium Ash	<div data-bbox="1239 1591 1523 1898"> <p>Additional Edge Finishes</p> E11 Medium Tone E12 Dark Tone </div>
 E6 Light Gray	 E13 Licorice	 E23 Sandstone	 E31 Arctic	

METAL BASE TABLE STANDARD FINISHES - BASES

Finish

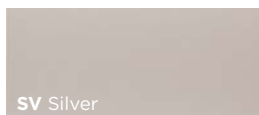
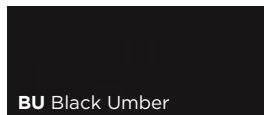

MESA

CONFERENCE TABLES





THE ULTIMATE IN PLUG & PLAY CONFERENCING

Meeting set up has never been simpler. Friant's innovative inset trough holds voice, data, and electrical outlets that keep cables organized and out of sight for an uncluttered surface conducive to focus and planning. The trough has a brushed opening and the capacity for enough voice/data and electrical wiring to power up each seat at the table. Additional cable storage space in bases.



Beneath Mesa's beauty is an ingenious design — power trough and bases that store and organize cables for a complete plug and play experience



Trough Intelligence

Friant's innovative trough organizes voice, data, and electrical cables with separate raceways for power and data.

Custom without cost

With three table shapes, a dozen edge finishes and multiple base finish options, each Mesa table can be designed with a unique aesthetic. Mesa marries beauty and functionality while remaining at a competitive price point.



Cables have two entry points to the power and data ports — through the top doors and the base columns with detachable covers. Open channel in the base also holds cables and wires.

Mesa makes connectivity easy with IT access integral to its design.

VOICE & DATA

Separate channels for voice and data keeps the cable area organized

Voice/data jacks and wiring not included.

POWER

Power capacity matches table seating, so each person at the table has a power and data outlet.

example:

An 8 ft. table has 8 outlets, a 12 ft. table has 12 outlets, etc.

Power strips are single circuit soft wire style plug-in.

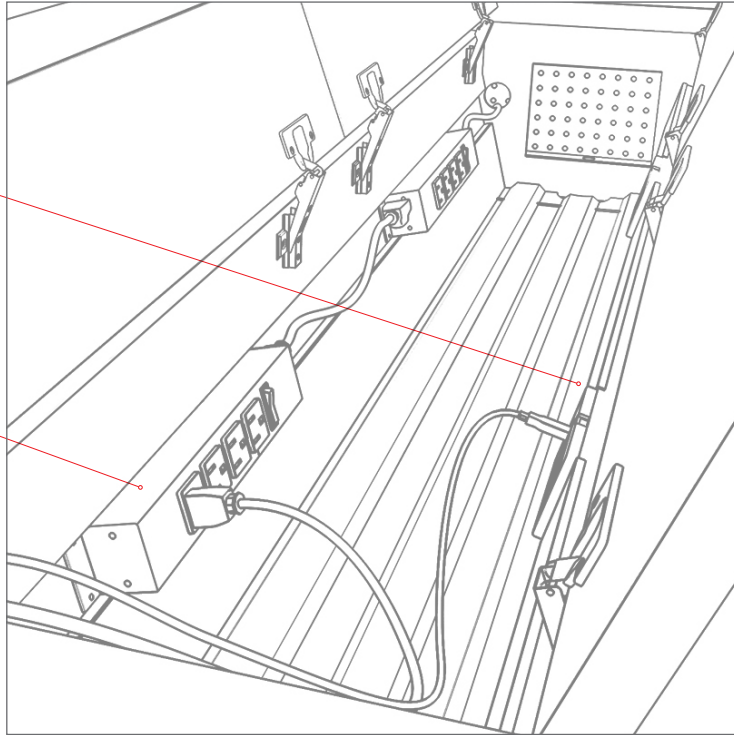

For dimensions, see page 57





Mesa is as environmentally sound as it is innovative, with materials that offer air quality assurance and LEED point contributions for recycled content

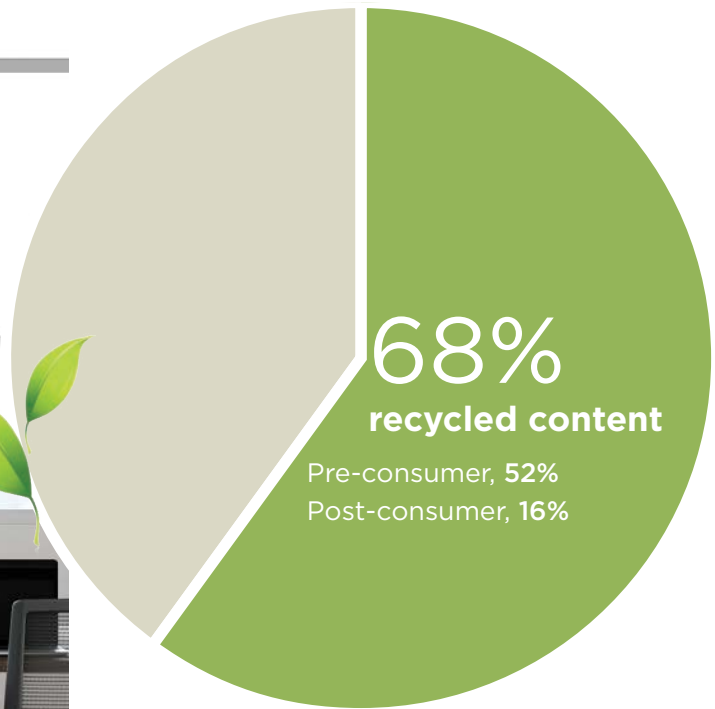

*LEED point contributions will vary according to table specifications; this chart references the table shown on page 45

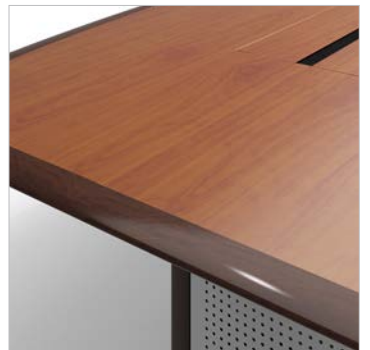
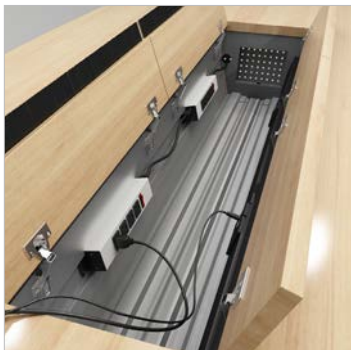

ORDERING MESA IS EASY! 4 SIMPLE STEPS:

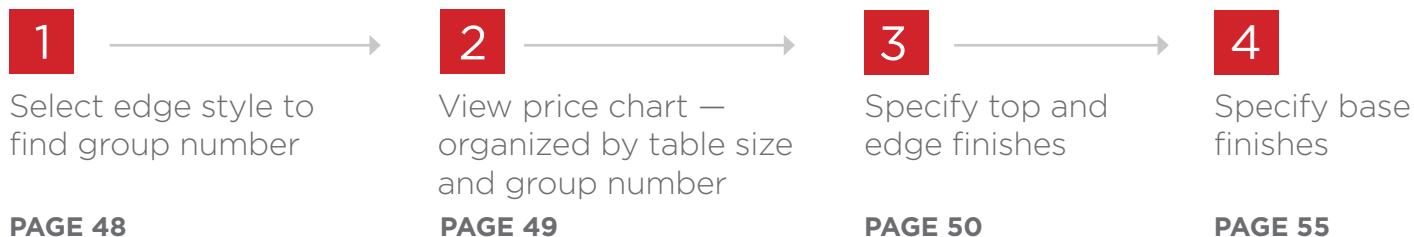

ANATOMY OF A PRODUCT NUMBER

MTB-BT-3648240-10-K

MODEL NO.

EDGE GROUP

EDGE STYLE

Model numbers are found in the pricing table on page 49. Add the edge group and style to create the complete product number for your Mesa table.

Be sure to specify finishes and base options in the description of your order.

Example:

MTB-BT-3648240-10-K

Description:

Mesa Table, Boatshaped, 36 x 48 x 240, Style Group 10, Edge Style K

Top Finish: VN01 American Cherry

Edge Finish: VD01 American Cherry

Base Inset Finish: VB01 American Cherry

Base Column Finish: VC01 American Cherry

American Cherry top and edge, with American Cherry base insert and columns

1 SELECT STYLE GROUP

Your choice of top and edge material determines your edge style options.



Laminate (self) edge PVC edge

Group 1

Laminate top with laminate or PVC edge



Group 9

Laminate top with solid wood edge



Group 10

Veneer top with solid wood edge

Available Edge Styles: A & B

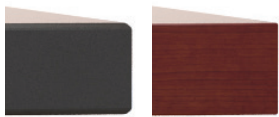

A 3 mm PVC B Self Edge

Available Edge Styles: J, K, J, M, N, P, Q



J Radius



K Bevel



L Beaded



M Knife



N Reverse Knife



P Double Radius



Q Bullnose

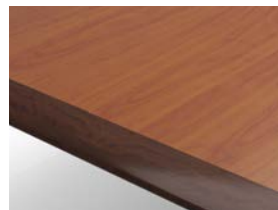

Group 12

Laminate top with solid wood edge



Group 13

Veneer top with solid wood edge

Available Edge Styles: S, T, W



S Ellipse 2.5"



T Ellipse 3.5"



W Ellipse 4.5"

2 FIND STYLE GROUP PRICING

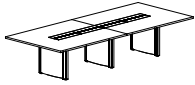

Rectangle Table

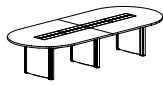

Racetrack Table

Size	Model No.	Model No.	Group 1	Group 9	Group 10	Group 12	Group 13
4' x 8'	MTB-RE-4896	MTB-RT-4896	\$12,072	\$18,518	\$20,274	\$23,793	\$26,137
4' x 9'	MTB-RE-48108	MTB-RT-48108	\$13,226	\$20,289	\$22,214	\$26,067	\$28,636
4' x 10'	MTB-RE-48120	MTB-RT-48120	\$15,762	\$24,179	\$26,473	\$31,065	\$34,125
4' x 11'	MTB-RE-48132	MTB-RT-48132	\$18,433	\$28,274	\$30,957	\$36,326	\$39,907
4' x 12'	MTB-RE-48144	MTB-RT-48144	\$18,805	\$29,373	\$32,161	\$37,739	\$41,456
4' x 14'	MTB-RE-48168	MTB-RT-48168	\$19,149	\$33,794	\$37,001	\$43,418	\$47,695
4' x 16'	MTB-RE-48192	MTB-RT-48192	\$22,028	\$35,504	\$38,874	\$45,615	\$50,110
4' x 18'	MTB-RE-48216	MTB-RT-48216	\$22,122	\$42,761	\$46,821	\$54,940	\$60,354
4' x 20'	MTB-RE-48240	MTB-RT-48240	\$23,145	\$44,744	\$48,995	\$57,489	\$63,153
4' x 22'	MTB-RE-48264	MTB-RT-48264	\$24,432	\$48,556	\$53,199	\$62,424	\$68,575
5' x 10'	MTB-RE-60120	MTB-RT-60120	\$18,805	\$28,845	\$31,582	\$37,059	\$40,710
5' x 12'	MTB-RE-60144	MTB-RT-60144	\$22,122	\$33,934	\$37,156	\$43,600	\$47,895
5' x 14'	MTB-RE-60168	MTB-RT-60168	\$24,432	\$37,478	\$37,484	\$48,152	\$52,898
5' x 16'	MTB-RE-60192	MTB-RT-60192	\$26,690	\$40,943	\$44,830	\$52,604	\$57,785
5' x 18'	MTB-RE-60216	MTB-RT-60216	\$31,844	\$48,847	\$53,487	\$62,759	\$68,941
5' x 20'	MTB-RE-60240	MTB-RT-60240	\$34,280	\$52,584	\$57,575	\$62,231	\$74,216
5' x 22'	MTB-RE-60264	MTB-RT-60264	\$36,212	\$55,548	\$60,822	\$71,372	\$78,401

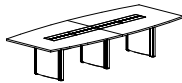

Boatshape Table

Size	Model No.	Group 1	Group 9	Group 10	Group 12	Group 13
3' x 4' x 8'	MTB-BT-364896	\$12,072	\$18,518	\$20,274	\$23,793	\$26,137
3' x 4' x 9'	MTB-BT-3648108	\$13,226	\$20,289	\$22,214	\$26,067	\$28,636
3' x 4' x 10'	MTB-BT-3648120	\$15,762	\$24,179	\$26,473	\$31,065	\$34,125
3' x 4' x 11'	MTB-BT-3648132	\$18,433	\$28,274	\$30,957	\$36,326	\$39,907
3' x 4' x 12'	MTB-BT-3648144	\$19,149	\$29,373	\$32,161	\$37,739	\$41,456
3' x 4' x 14'	MTB-BT-3648168	\$22,028	\$33,794	\$37,001	\$43,418	\$47,695
3' x 4' x 16'	MTB-BT-3648192	\$23,145	\$35,504	\$38,874	\$45,615	\$50,110
3' x 4' x 18'	MTB-BT-3648216	\$27,875	\$42,761	\$46,821	\$54,940	\$60,354
3' x 4' x 20'	MTB-BT-3648240	\$29,169	\$44,744	\$48,995	\$57,489	\$63,153
3' x 4' x 22'	MTB-BT-3648264	\$31,673	\$48,587	\$53,199	\$62,424	\$68,575
4' x 5' x 10'	MTB-BT-4860120	\$18,805	\$28,845	\$31,582	\$37,059	\$40,710
4' x 5' x 12'	MTB-BT-4860144	\$22,122	\$33,934	\$37,156	\$43,600	\$47,895
4' x 5' x 14'	MTB-BT-4860168	\$24,432	\$37,478	\$41,036	\$48,152	\$52,898
4' x 5' x 16'	MTB-BT-4860192	\$26,690	\$40,943	\$44,830	\$52,604	\$57,785
4' x 5' x 18'	MTB-BT-4860216	\$31,844	\$48,847	\$53,487	\$62,759	\$68,941
4' x 5' x 20'	MTB-BT-4860240	\$34,280	\$52,584	\$57,575	\$67,559	\$74,216
4' x 5' x 22'	MTB-BT-4860264	\$36,212	\$55,548	\$60,822	\$71,372	\$78,401

3 SELECT FINISHES: TOP

Table top finish choices includes laminate or veneer. See chart below

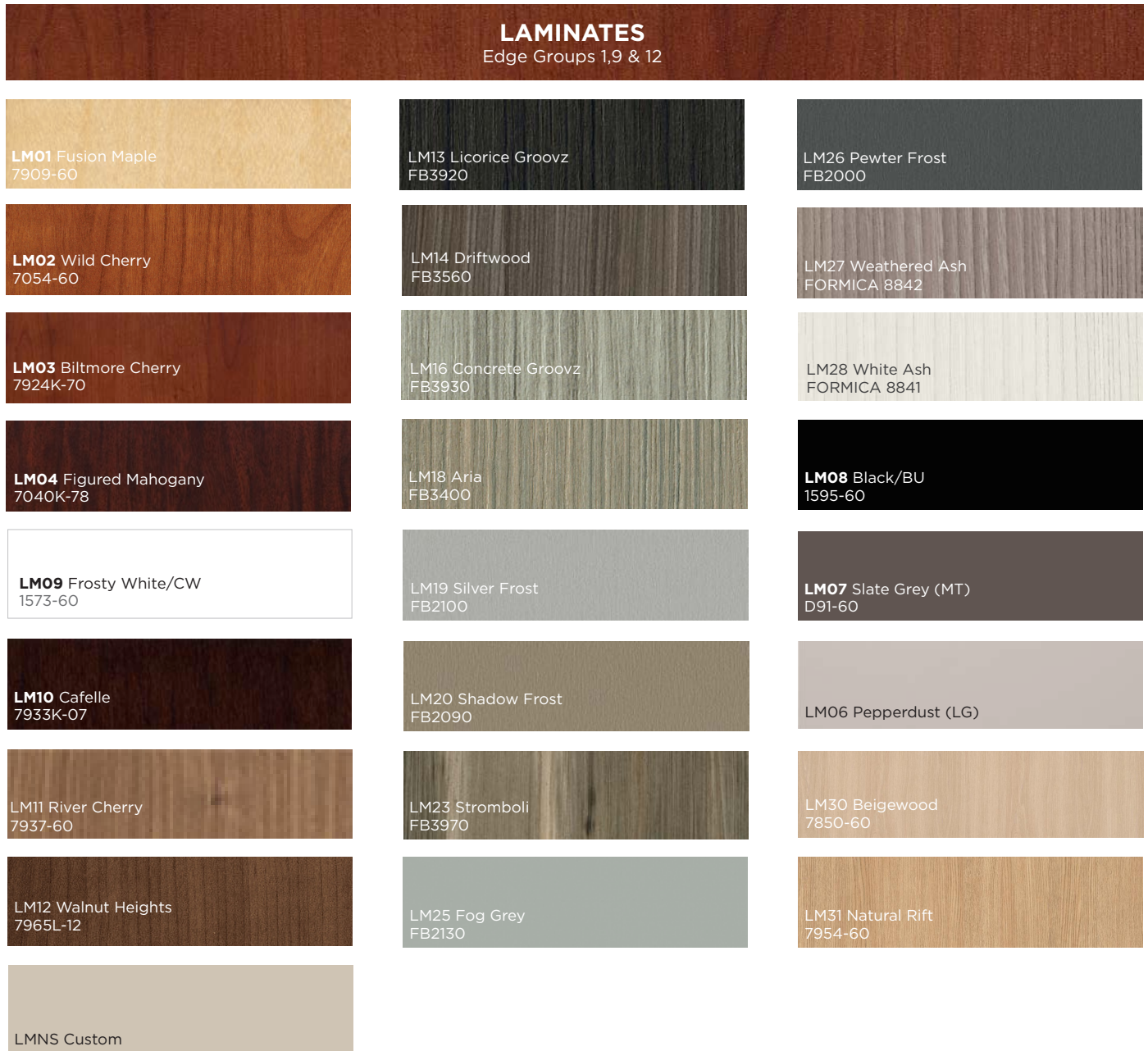

CARB COMPLIANT

Willow laminates meet or exceed California (CARB) air quality emission standards — the most stringent in the country — for composite wood products.

Contact suppliers directly for hardsurface panel **finish samples**.

Wilsonart

tel: 800-433-3222, <https://www.wilsonart.com/contact-us>

Formica

tel: 800-367-6422, <https://www.formica.com/en-us/collections/commercial-ranges>

Arauco

Samples can be ordered at <https://store.samplingproduct.com/8340>

3 SELECT FINISHES: VENEER

Table top finish choices: Veneer

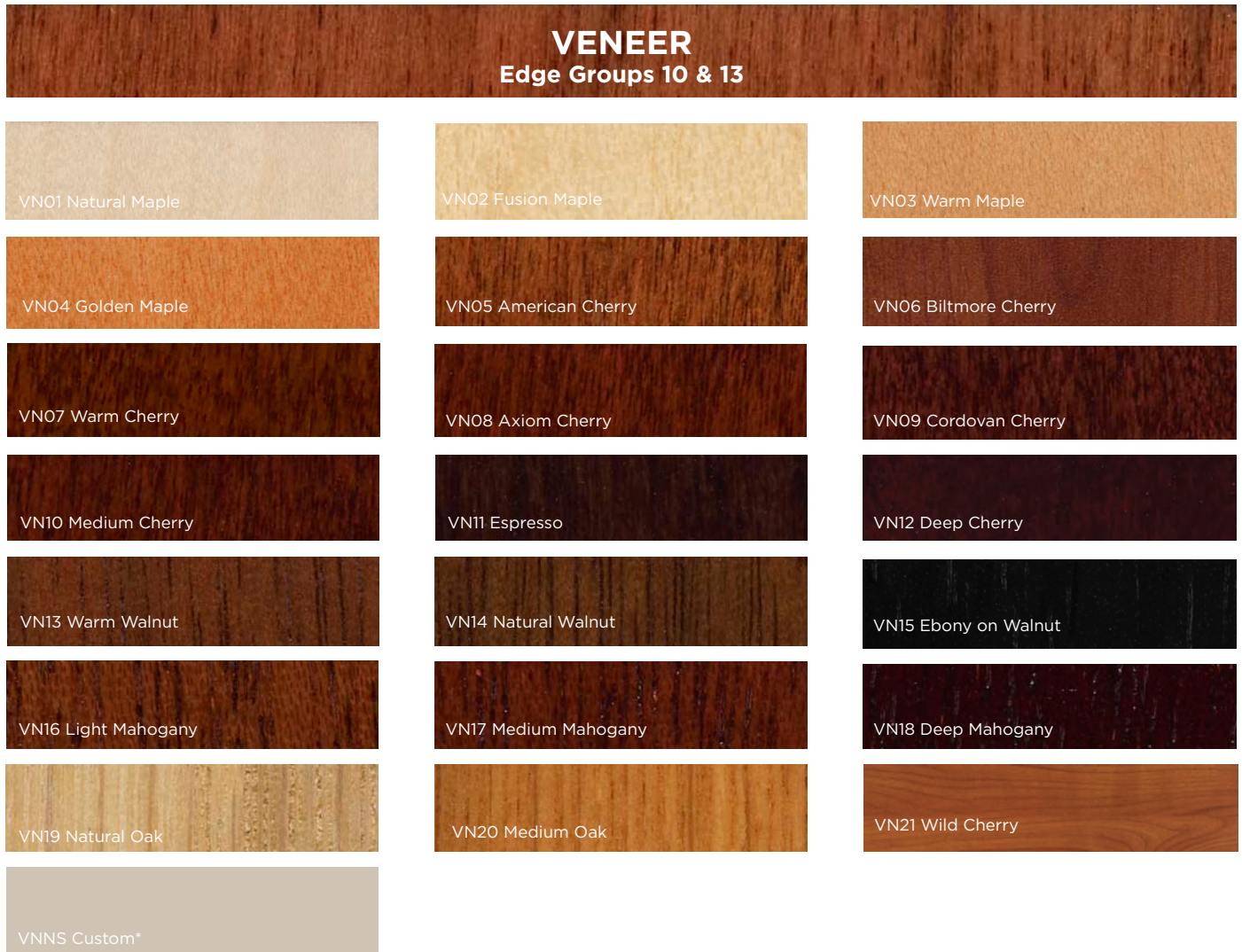

* For pricing on custom finishes, contact your Friant Sales Consultant.

3 SELECT FINISHES: EDGE



Table edge finish choices: solid wood

SOLID WOOD EDGE

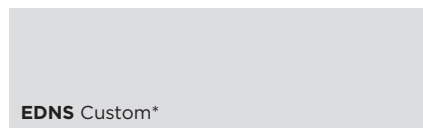
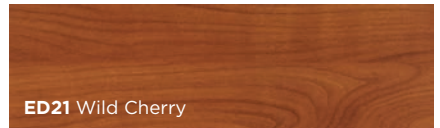
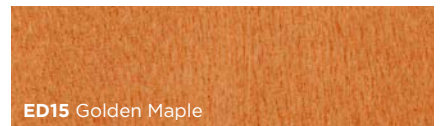
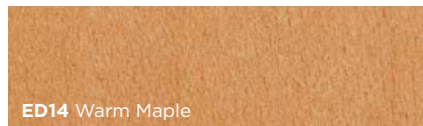
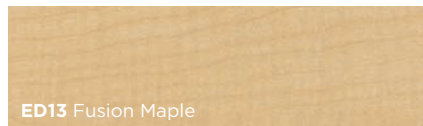
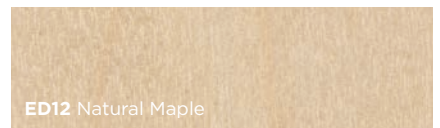
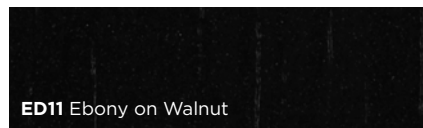
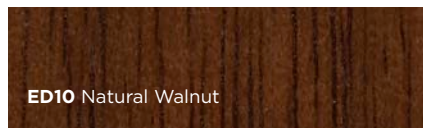
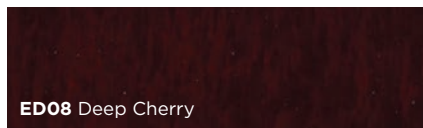
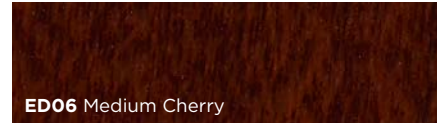
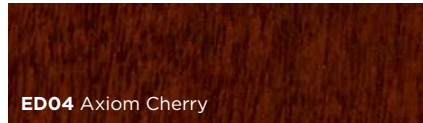
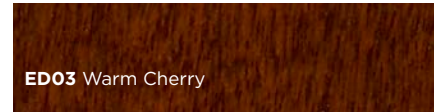
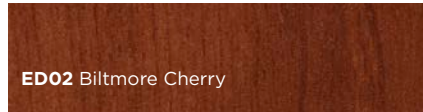
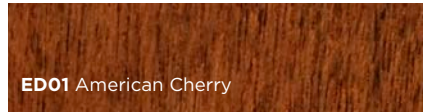

3 SELECT FINISHES: EDGE

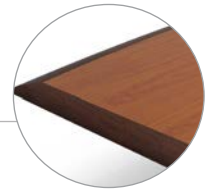
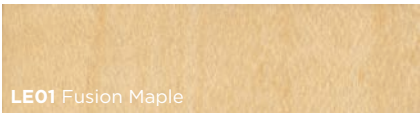
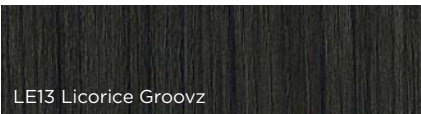
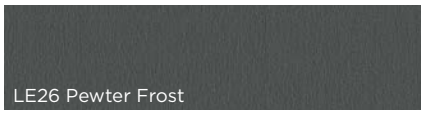
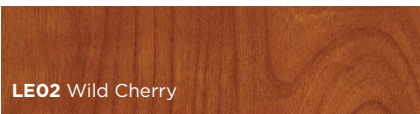

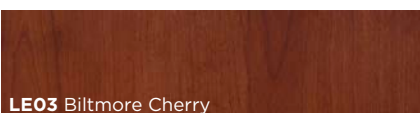
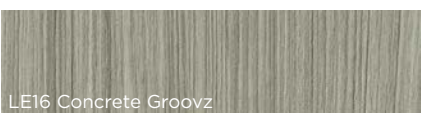



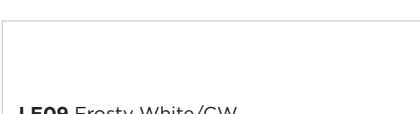

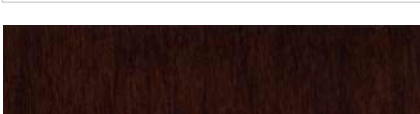







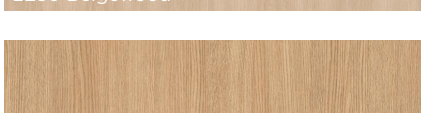
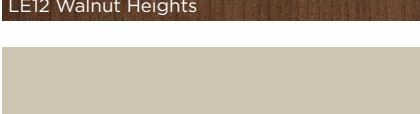
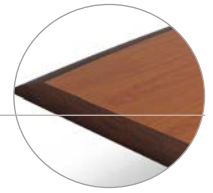

Table edge finish choices: Laminate and PVC.

LAMINATE EDGE

 LE01 Fusion Maple	 LE13 Licorice Groovz	 LE26 Pewter Frost
 LE02 Wild Cherry	 LE14 Driftwood	 LE27 Weathered Ash
 LE03 Biltmore Cherry	 LE16 Concrete Groovz	 LE28 White Ash
 LE04 Figured Mahogany	 LE18 Aria	 LE08 Black/BU
 LE09 Frosty White/CW	 LE19 Silver Frost	 LE05 Slate Grey (MT)
 LE10 Cafelle	 LE20 Shadow Frost	 LE06 Pepperdust (LG)
 LE11 River Cherry	 LE23 Stromboli	 LE30 Beigewood
 LE12 Walnut Heights	 LE25 Fog Grey	 LE31 Natural Rift
 LMNS Custom		



PVC EDGE

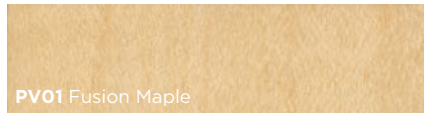

PV01 Fusion Maple

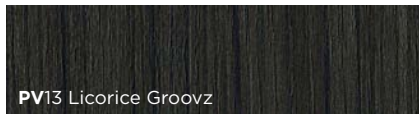

PV13 Licorice Groovz

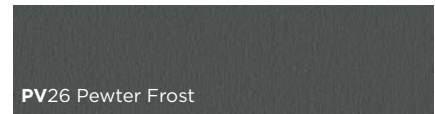

PV26 Pewter Frost

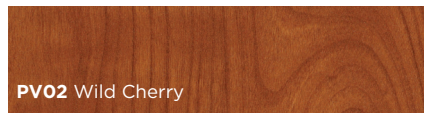

PV02 Wild Cherry



PV14 Driftwood

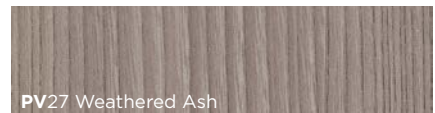

PV27 Weathered Ash

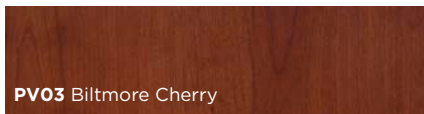

PV03 Biltmore Cherry

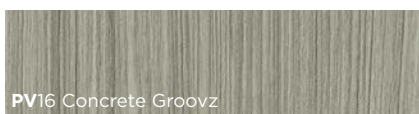

PV16 Concrete Groovz

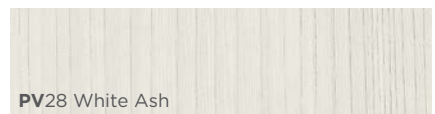

PV28 White Ash

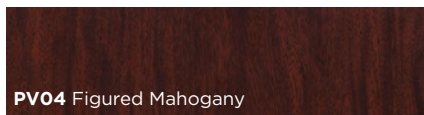

PV04 Figured Mahogany



PV18 Aria



PV08 Black/BU

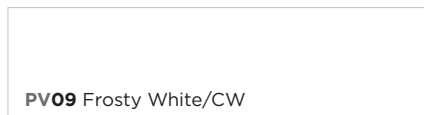

PV09 Frosty White/CW

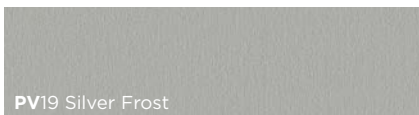

PV19 Silver Frost

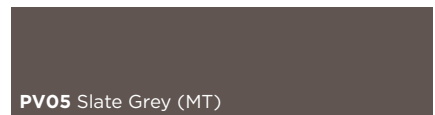

PV05 Slate Grey (MT)



PV10 Cafelle

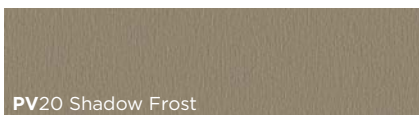

PV20 Shadow Frost

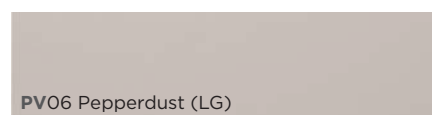

PV06 Pepperdust (LG)

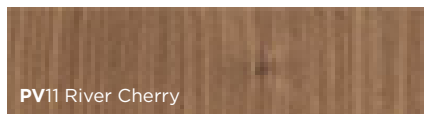

PV11 River Cherry



PV23 Stromboli



PV30 Beigewood



PV12 Walnut Heights



PV25 Fog Grey

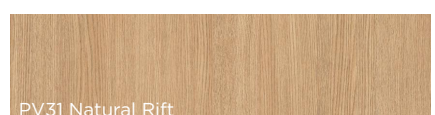

PV31 Natural Rift



LMNS Custom



Order samples at www.friant.com

Please Note: Images are printed simulations and are not exact matches of finished product. Please request an actual sample from Friant or your sales consultant before specifying finishes.

4 SELECT BASE OPTION

Select an inset finish and column finish. A standard Mesa table has a perforated metal base inset and metal columns available in Aluminum, Black or White finish.

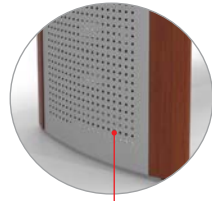

Inset Finishes

Veneer, laminate and metal insets available with additional cost — see upcharge table below.

Metals (Standard):

- MBST** Perforated Aluminum
- MBSB** Perforated Black
- MBSW** Perforated White

Insets with upcharge:

Veneers

- VBME** Match Edge
- VB01** American Cherry
- VB02** Biltmore Cherry
- VB03** Warm Cherry
- VB04** Axiom Cherry
- VB05** Cordovan Cherry
- VB06** Medium Cherry
- VB07** Espresso
- VB08** Deep Cherry
- VB09** Warm Walnut
- VB10** Natural Walnut
- VB11** Ebony on Walnut
- VB12** Natural Maple
- VB13** Fusion Maple
- VB14** Warm Maple
- VB15** Golden Maple
- VB16** Light Mahogany
- VB17** Medium Mahogany
- VB18** Deep Mahogany
- VB19** Natural Oak
- VB20** Medium Oak
- VB21** Wild Cherry
- VBNS** Custom†

Laminates

- LB01** Fusion Maple
- LB02** Wild Cherry
- LB03** Biltmore Cherry
- LB05** Figured Mahogany
- LB09** Black
- LB29** Frosty White
- LB10** Cafelle
- LB11** River Cherry
- LB12** Walnut Heights
- LB13** Licorice Groovz
- LB14** Driftwood
- LB16** Concrete Groovz
- LB18** Aria
- LB19** Silver Frost
- LB20** Shadow Frost
- LB23** Stromboli
- LB25** Fog Grey
- LB26** Pewter Frost
- LB27** Weathered Ash
- LB28** White Ash
- LB04** Slate Grey
- LB06** Pepperdust
- LB30** Beigewood
- LB31** Natural Rift
- LBNS** Custom†

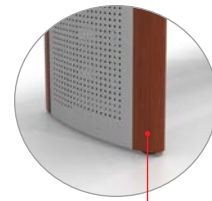

Column Finishes

Veneer columns available with additional cost — see upcharge table below.

Metals (Standard):

- VCST** Aluminum
- VCSB** Black
- VCSW** White

Columns with upcharge:

Veneers

- VC01** American Cherry
- VC02** Biltmore Cherry
- VC03** Warm Cherry
- VC04** Axiom Cherry
- VC05** Cordovan Cherry
- VC06** Medium Cherry
- VC07** Espresso
- VC08** Deep Cherry
- VC09** Warm Walnut
- VC10** Natural Walnut
- VC11** Ebony on Walnut
- VC12** Natural Maple
- VC13** Fusion Maple
- VC14** Warm Maple
- VC15** Golden Maple
- VC16** Light Mahogany
- VC17** Medium Mahogany
- VC18** Deep Mahogany
- VC19** Natural Oak
- VC20** Medium Oak
- VC21** Wild Cherry
- VCNS** Custom†

Base Option Upcharges

Table length	Veneer Inset	Laminate Inset	Veneer columns
8', 9', 10'	\$2,766	\$1,660	\$2,766
11', 12', 14', 16	\$4,150	\$2,490	\$4,150
18', 20', 22'	\$5,532	\$3,319	\$5,532

†For pricing on custom finishes, contact your Friant Sales Consultant.

SELECT BASE OPTION CONTINUED

STANDARD MESA BASE: Matching inset and columns, 3 color choices.



INSET: Perforated metal
 MBST Aluminum
 MBSB Black
 MBSW White

COLUMNS: Metal
 VCST Aluminum
 VCSB Black
 VCSW White

Specify MBST/VCST, MBSB/VCSB, or MBSW/VCSW

ADDITIONAL BASE DESIGNS: Please see upcharge chart



INSET: Laminate
COLUMNS: Aluminum



INSET: Perforated Aluminum
COLUMNS: Veneer



INSET:
 Veneer

COLUMNS:
 Aluminum

SPECIFICATIONS
CONFERENCE
MESA

NUMBER OF DOORS, BASES AND SEAMS

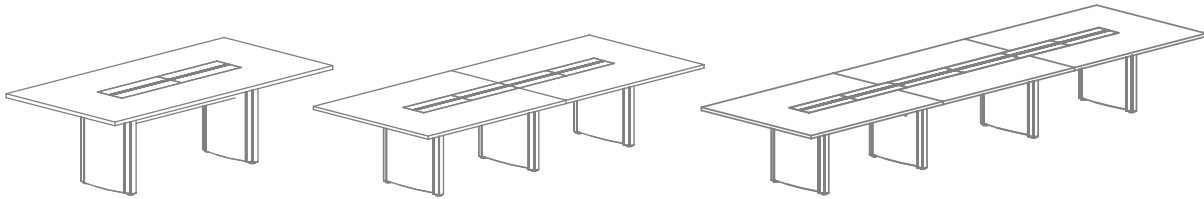
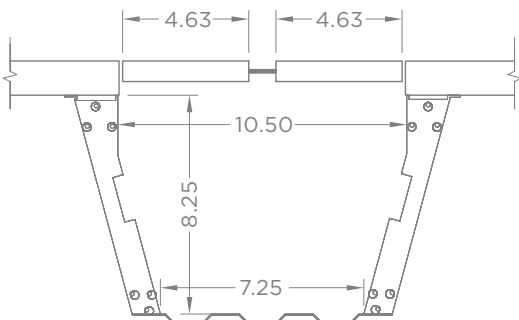

Table Length	8 ft	9 ft	10 ft	11 ft	12 ft	14 ft	16 ft	18 ft	20 ft	22 ft
Doors	4	4	4	4	8	8	8	12	12	12
Bases	2	2	2	3	3	3	3	4	4	4
Seams	0	1	1	1	1	1	2	2	2	2

TROUGH DIMENSIONS



INSIDE BASE CLEARANCE

Base for 48" Wide Top

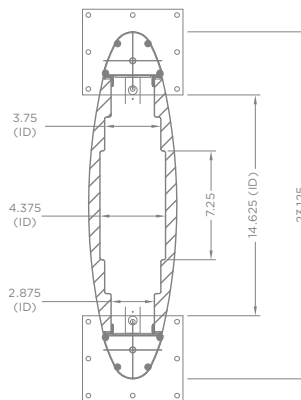

Base for 60" Wide Top

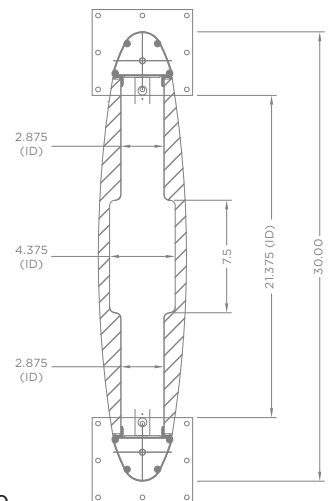

Drawings with base locations for core drilling are available at www.friant.com

TERMS & CONDITIONS

PRICES

All prices are F.O.B. point. We reserve the right to change prices without prior notice.

ORDERING

Purchase Orders should be sent to Friant & Associates, LLC at orders@friant.com, or faxed to (510) 535-6895. If your specifications were created with CAP, GIZA, or Project Matrix please send the worksheet (SP4) with your Purchase Order.

TERMS

Net 30 days from date of invoice with established terms. Invoices are delinquent if not paid (30) days from date of invoice. In the event timely payment is not made, interest will be charged at the rate of 1.5% per month on delinquent accounts. Buyers will also be liable for normal collection costs and attorney fees.

ORDERS

Orders are only accepted by issuance of our formal acknowledgment, and are subject to the terms set forth herein and on our order acknowledgment. It is the responsibility of the buyer to review our acknowledgment for accuracy.

LEAD TIME

Lead times are subject to availability.

ORDER CHANGES AND CANCELLATIONS

Our order confirmation is final and binding. Any order change or cancellation is subject to our ability to conform. For the most up to date information, always review the order change/cancellation policy online. Allowable changes within the posted policy must be made in writing.

RETURNS

No merchandise may be returned without our written consent and shipping instructions, and are subject to a 35% restocking fee. Unauthorized returns will not be accepted and will be returned freight collect. All packages are labeled with contents, and it is the customer's responsibility to check box labels against the packing list for accuracy before opening. If correctly labeled and undamaged product is removed from its original packaging, Friant will not accept its return.

CLAIMS

We are not responsible for damage suffered in transit. Merchandise should be inspected for possible freight damage upon delivery. Claims for damage or shortages should be filed by the consignee with the carrier within 5 days of delivery. You are also protected for "concealed damage" if you file claim with the carrier within 5 days of delivery. All claims against Friant for defects, errors or shortages must be made by Buyer in writing within 10 days after delivery. Failure to make such a claim shall constitute full acceptance. All claims must be pre-approved and with a P.O. issued to Friant before reimbursement and/or reinstallation will be granted.

SHIPPING

Friant generally palletizes, boxes and/or shrink wraps its products. If Buyer requests additional packaging or special shipping, extra charges will apply. Buyer obtains title to products and assumes the risk of loss for them upon shipment from Friant's plant.

PARTIAL SHIPMENTS

We will make every attempt to ship orders complete and on schedule. However, we reserve the right to make partial shipments as merchandise is ready. Invoices covering these partial shipments are to be paid as they become due.

SHIPPING AND PREPAID FREIGHT

Unless otherwise instructed, we reserve the option to ship by what is, in our opinion, the best possible way. Upon request, we will prepay and add freight for accounts with established credit. Please see our web site for estimated freight times.

DELIVERY

We are not liable for delay or failure of delivery due to strikes and/or differences with workmen, war, riot, fire, compliance with government regulations, acts of nature, failure or delays of sources of supply, or any other causes beyond our control.

STORAGE

If buyer cannot accept delivery when merchandise is ready, we reserve the right to transfer goods to storage. Costs of transfer and storage will be charged to the buyer's account, and we will deem such transfer as constituting shipment for all purposes, including invoicing, as of the date the transfer is made.

CONSTRUCTION - SPECIFICATIONS

All items are produced to price list specifications unless otherwise advised. All dimensions shown are approximate. Manufacturer reserves the right to make modifications and/or improvements without prior notice.

COMPLIANCE WITH LAW

Purchaser is solely responsible for compliance with all applicable Federal, State and Local laws, ordinances, regulations, rules and standards relating to the installation, maintenance, use and operation of products.

TERMS & CONDITIONS

CALIFORNIA PROP 65 WARNING

Products in this catalog can expose you to chemicals including wood dust, which is known to the State of California to cause cancer or birth defects or other reproductive harm. For more information go to <https://www.p65warnings.ca.gov/products/furniture-products>.”

CARB

Friant products are CARB 93120 compliant for formaldehyde (phase 2)

TSCA TITLE VI

Friant products are TSCA Title VI Compliant

MAS

Accredited Compliance Designation - ANSI/BIFMA x7.1 & e3-2014 7.6.1, 7.6.2, 7.6.3

California Dept. Of Public Health Standard Method v1.2

Conforms With: LEED v4

Criteria of MAS Certified Green® Program

CARE AND MAINTENANCE

Friant & Associates' finish provides excellent stain and mar resistance. Care should be exercised when cleaning. The following precautions will help keep the product looking new:

- Dust all surfaces on a regular basis with a soft damp cloth. Do not use spray polishes – especially those containing silicone.
- Lift all objects from the surface when moving – never drag objects across the surface.
- Metal objects should be kept from contacting the surface.

TERMS & CONDITIONS

RIGHTS AND WARRANTIES – LIMITED LIFETIME WARRANTY

Warranty information for all Friant products can be found in the Dealer Resource Center (dealers.friant.com/warranty) or on the Friant website (www.friant.com/warranty)