

Catálogo de Anilhas Cirúrgicas



eee[®]

DENTAL COMPONENTES



Exporta para o exterior desde 2011.

Nobel Biocare®

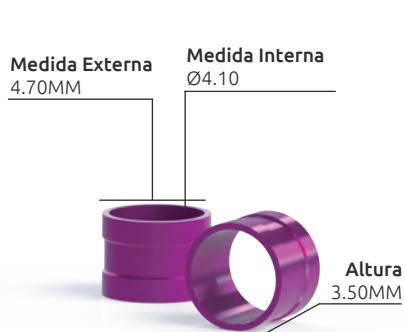

Anilha para Guia Cirúrgica NP
EFFC . AC01

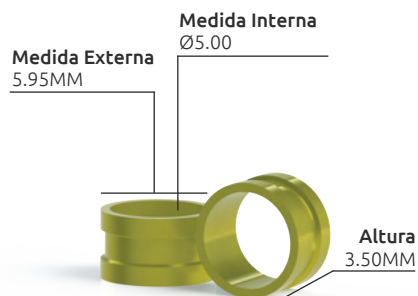

Anilha para Guia Cirúrgica RP
EFFC . AC02

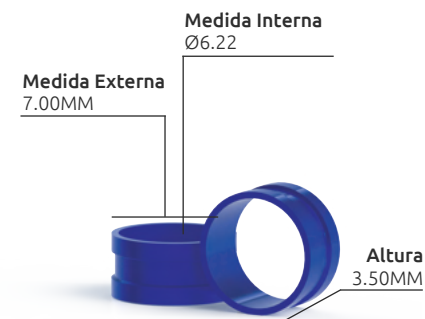

Anilha para Guia Cirúrgica WP/6.0
EFFC . AC03

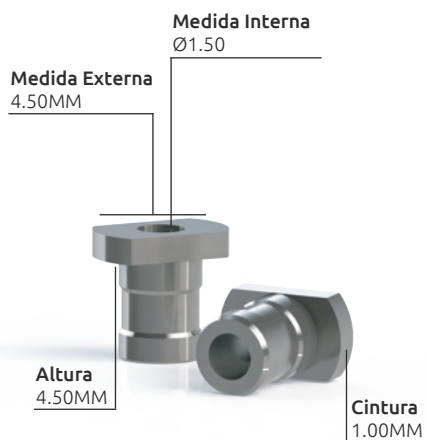

Anilha para Guia Cirúrgica
EFFC . AC180

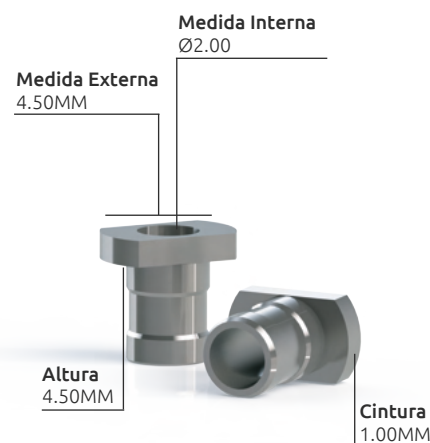

Anilha para Guia Cirúrgica
EFFC . AC181

Straumann®

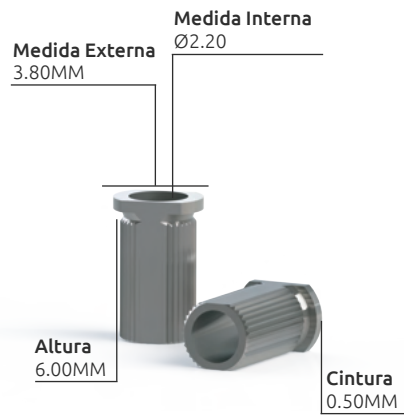

Anilha para Guia Cirúrgica
EFFC . AC11

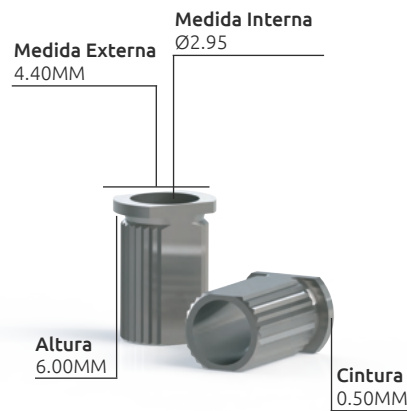

Anilha para Guia Cirúrgica
EFFC . AC07

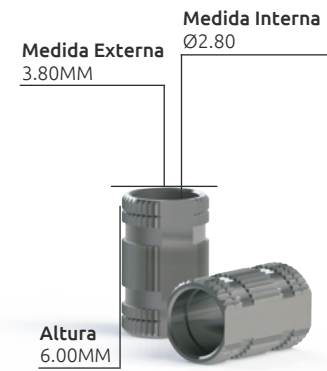

Anilha para Guia Cirúrgica
EFFC . AC09

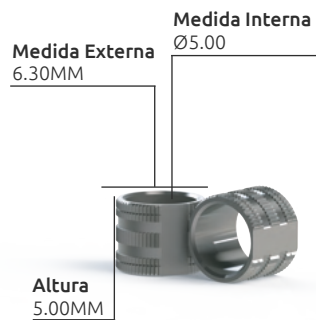

Anilha para Guia Cirúrgica
EFFC . AC08

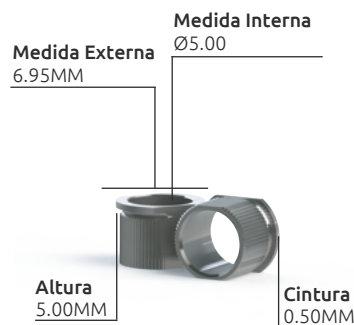

Anilha para Guia Cirúrgica
EFFC . AC06

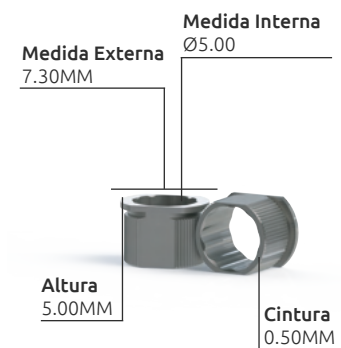

Anilha para Guia Cirúrgica
EFFC . AC10

Neodent®

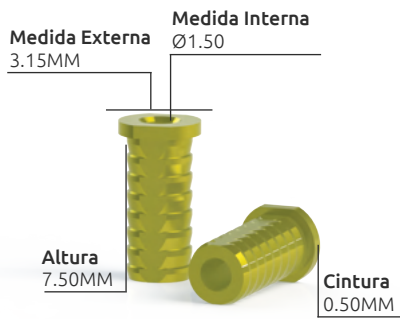

Anilha para Guia Cirúrgica
EFFC . AC24

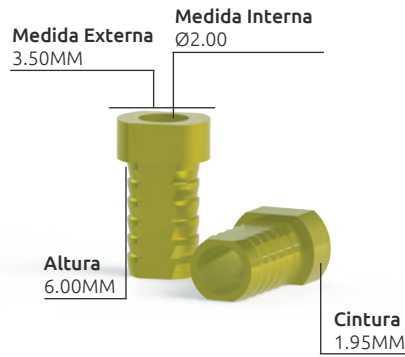

Anilha para Guia Cirúrgica
EFFC . AC23

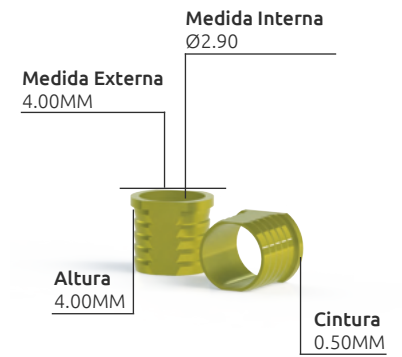

Anilha para Guia Cirúrgica
EFFC . AC22

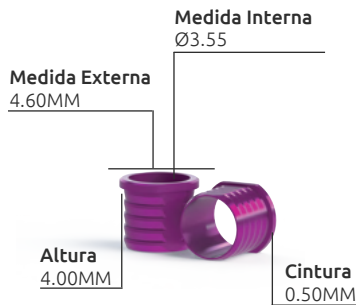

Anilha para Guia Cirúrgica
EFFC . AC04

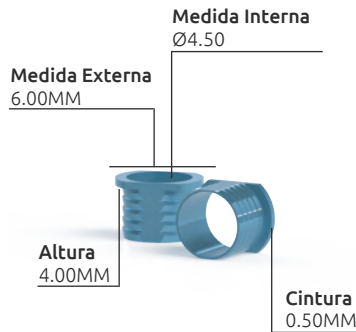

Anilha para Guia Cirúrgica
EFFC . AC20

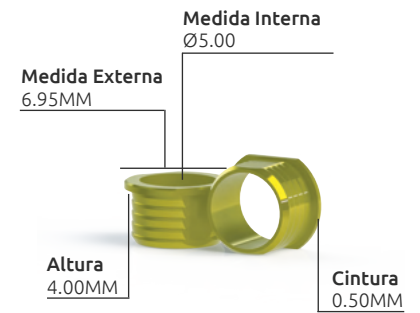

Anilha para Guia Cirúrgica
EFFC . AC05

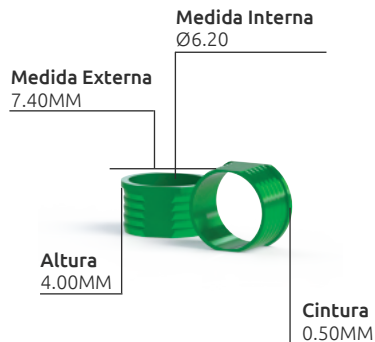

Anilha para Guia Cirúrgica
EFFC . AC21

SIN®

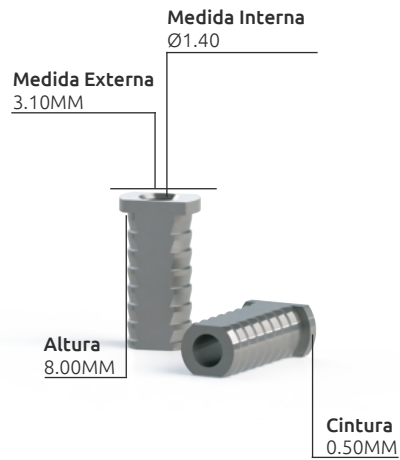

Anilha para Guia Cirúrgica
EFFC . AC30

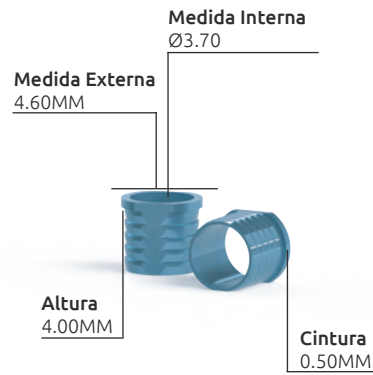

Anilha para Guia Cirúrgica
EFFC . AC31

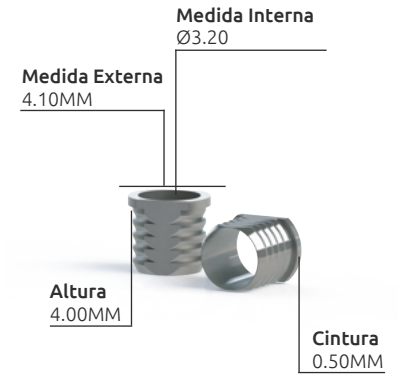

Anilha para Guia Cirúrgica
EFFC . AC34

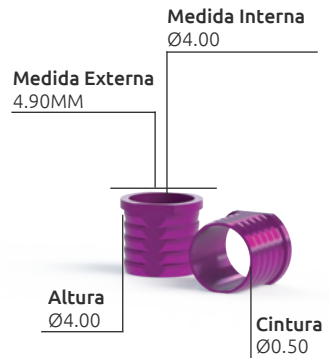

Anilha para Guia Cirúrgica
EFFC . AC33

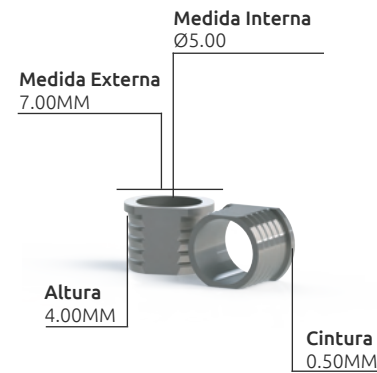

Anilha para Guia Cirúrgica
EFFC . AC32

MIS®

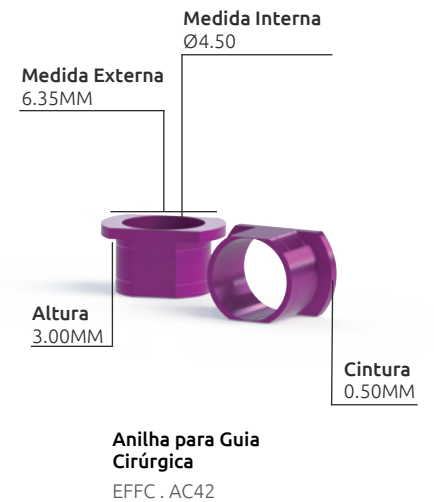
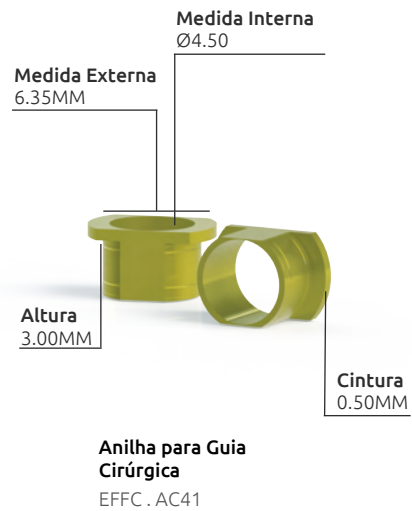
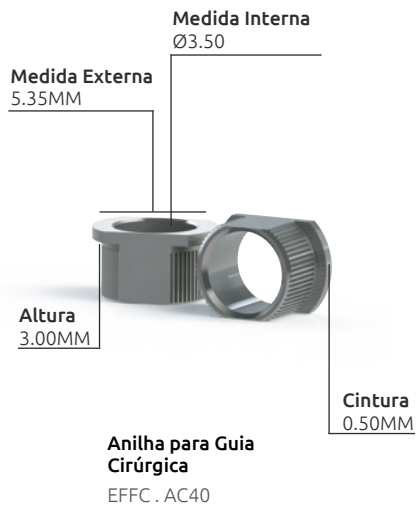

Acessórios

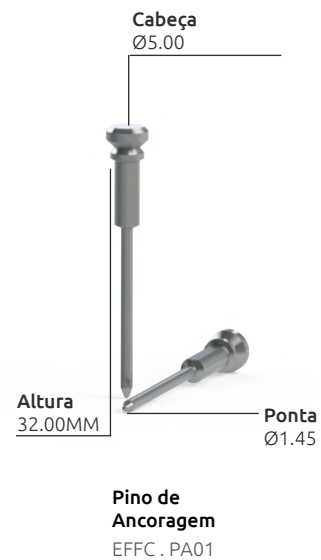



www.efdental.com.br

Rua Aurélia, 1620, Vila Romana, cep. 05046-001, São Paulo-SP
☎ 11 3059.2200 | @ atendimento@efdental.com.br | 🌐 www.efdental.com.br
f facebook.com/efdental | 📷 instagram.com/efdental