

# Eternity™

BIRD FEEDER

For Installation Videos and Tips visit,  
[www.EternityBirdFeederTips.com](http://www.EternityBirdFeederTips.com)

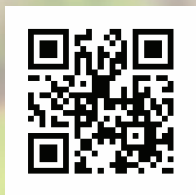

## Instruction Manual



# Contents

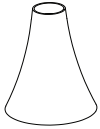

Cone (A) (X1)

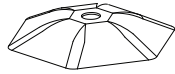

Cover (B) (X1)

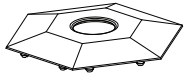

Roof Base (C) (X1)

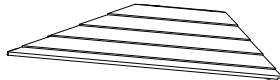

Roof Panel (D) (X6)

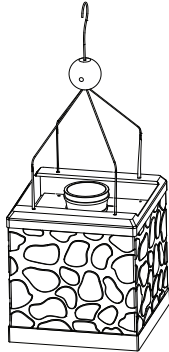

Base Assembly (E) (X1)

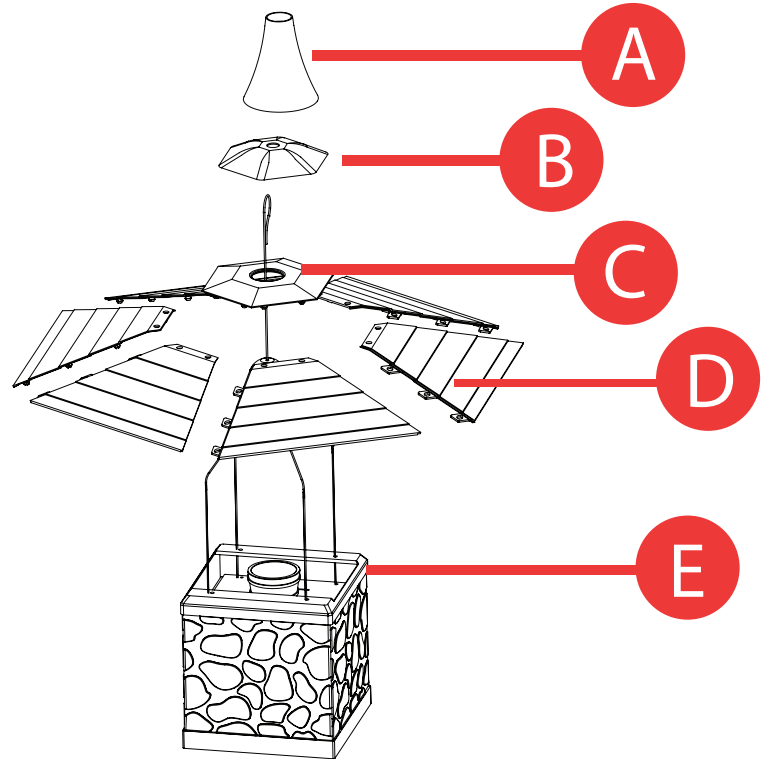

# Important Safety instructions

---

To protect against the risk of injury, follow the basic safety precautions below:

- Read all instructions.
- Do not load more than the maximum 5 LBS of food into the base. Overloading the base may cause damage to the product and injury.
- Do not alter or modify the product. Altering the product may cause damage to the product.

# Features

## Squirrel Resistant Roof Design:

Unique design allows the roof to pivot freely when weight is applied.

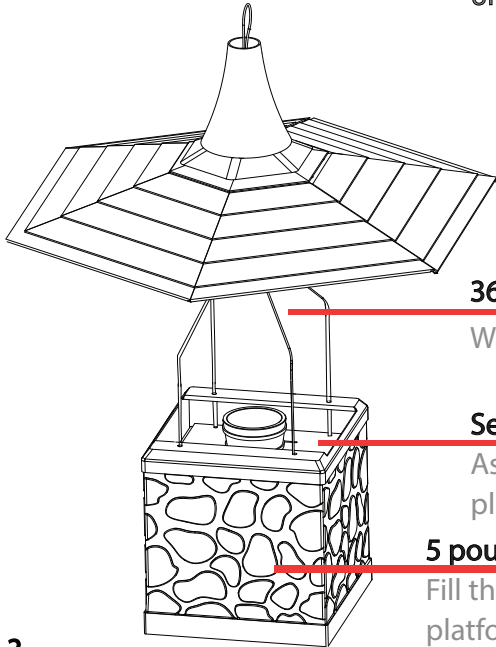

## 360 Degree View:

Watch birds eat from any angle.

## Self rising feed tray:

As the seeds are eaten, the self rising platform maintains seed level.

## 5 pound seed capacity:

Fill the feeder less often than other platform feeders.



# Assembling Your Eternity™ Bird Feeder

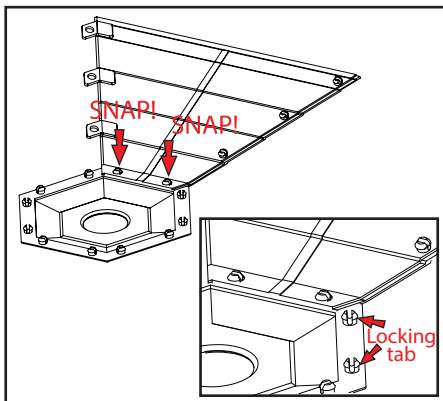

**1)** Place the Roof Base (C) on a flat surface with locking tabs facing upwards. Take 1 Roof Panel (D) and snap the 2 holes into the tabs on the Roof Base (C).

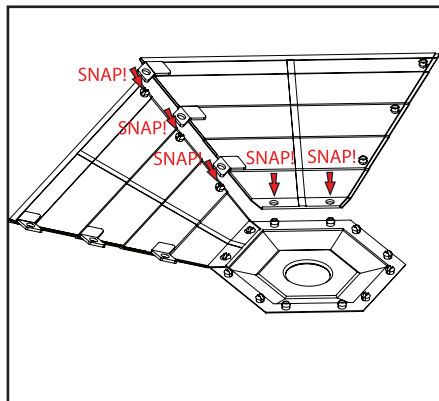

**2)** Take another Roof Panel (D) and line up the holes with the locking tabs of the other Roof Panel (D), and the Roof Base (C) and snap all into place. Repeat this step for the next 3 Roof Panels(D).

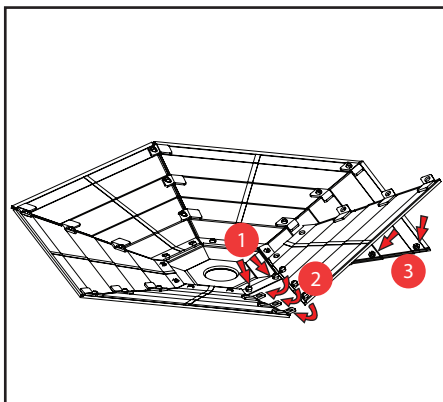

**3)** IMPORTANT: The last Roof Panel (D) must be inserted on an angle to ensure proper alignment. Angle the panel diagonally as shown. Snap the 2 holes into the Roof Base (C). Next, snap the 3 tabs underneath roof Panel (D). Finally, snap in the 3 remaining holes on the other end of the Roof Panel.

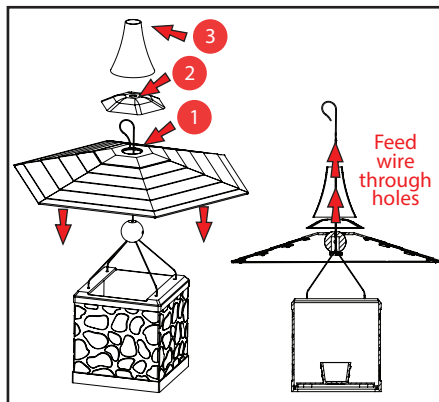

**4)** After the roof is assembled, first feed the wire through the hole in the middle of the Roof Base (C). The roof should rest on the ball from the Base Assembly. Next, feed the wire through the Roof Cover (B). Feed the wire through the Cone Cover (A).

# Setting Up Your Eternity™ Bird Feeder

- For maximum squirrel resistance, mount the Eternity™ Bird Feeder in the middle of a horizontally suspended rope, or wire 6 feet above the ground, and 10 feet away from any tree or tree branch.

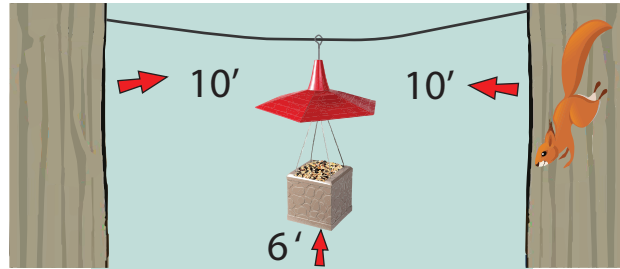

## Filling your Eternity™ Bird Feeder with bird seed.

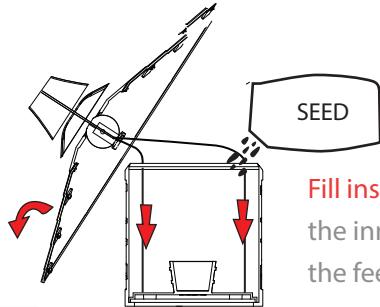

**Fill instructions:** Set the feeder roof to the side and ensure that the inner platform is resting at the bottom of the outer box. Fill the feeder to the top of the box.



Unit is now full



As the food is consumed, the inner tray will rise up.



When the small cup on the inner tray is exposed, its time to refill.

Eternity™  
BIRD FEEDER



ALLSTAR  
I N N O V A T I O N S™

©2020 ALLSTAR INNOVATIONS  
Eternity™ Bird Feeder is a trademark of ALLSTAR INNOVATIONS  
Distributed by ALLSTAR INNOVATIONS  
Hawethorne, NY 10532  
Made in China.  
Patent D704,387 S