



Electrosteel USA

09  
EDITION



**PUSH** TITE

## 3" - 24" Ductile Iron Pipe

Used for Water & Wastewater, Fire  
Protection & Industrial Applications

---

[www.ElectrosteelUSA.com](http://www.ElectrosteelUSA.com)



- 3** PushTite Pipe
- 3** ANSI/AWWA Standards
- 4** Pipe Assembly
- 5** Alternate Methods for Assembly
- 7** Preparing a Field-Cut Pipe
- 8** Gasket Storage
- 9** Angular Deflection
- 10** Pipe Diameters
- 11** Bell Dimensions
- 12** Pressure Class
  - Nominal Thickness for Standard Pressure Classes of Ductile Iron Pipe
- 13** Pressure Class
  - Thickness, Dimensions and Weight
- 14** Thickness Class
  - Thickness, Dimensions and Weight
- 17** Maximum Deflection
  - 18 Foot Length Pipe
- 18** Products for Water, Wastewater and Fire Protection

---

[www.ElectrosteelUSA.com](http://www.ElectrosteelUSA.com)





## **PUSH** **TITE** Ductile Iron Pipe

### PUSHTITE PIPE

PushTite Pipe by Electrosteel is a push-on type connection known for its rugged design, ease of use and water tightness. PushTite Pipe is available in sizes 3" through 24". All diameters of PushTite Pipe are UL Listed.

All PushTite Pipe is beveled for trouble-free assembly and is available in all AWWA C150 Pressure and Thickness Classes. Through careful manufacturing and intensive quality control, all of our pipe can withstand pressures in excess of their ratings.

### ANSI/AWWA STANDARDS

PushTite Pipe represents the highest quality achievable in ductile iron. We meet or exceed every standard required. Those standards are shown below.

- Centrifugally casting for water standard meet ANSI/AWWA C151/A21.5
- Cement lining and fittings for water adhere to ANSI/AWWA C104/A21.4
- Metal molds, centrifugally casting to ANSI/AWWA C151/A21.5
- Asphalt coatings conform with ANSI/AWWA C151/A21.51
- Pipe weight standards adhere to ANSI/AWWA C151/A21.51
- Lining and coatings conform with ANSI/AWWA C104/A21.4
- Special linings and coatings available
- PushTite Rubber Gasket Joints meet ANSI/AWWA C111/A21.11
- PushTite RJ Gaskets meet ANSI/AWWA C111/A21.11
- Polyethylene encasement for ductile iron pipe in accordance to ANSI/AWWA C105/A21.5

**NOTE** When there is potential for installation in corrosive soils, ANSI/AWWA C105/A21.5 should be consulted for quality assurance.



# **PUSH TITE** Ductile Iron Pipe

## PIPE ASSEMBLY

**FIG. 1 GASKET INSERTION**

The inside of sockets and the outside of spigots should be cleaned up to the insertion depth. Gaskets should be wiped clean and inspected for damage. The gasket should then be placed into the socket groove, rounded end entering first. Seating the gasket is made easier by forming the gasket into a loop during insertion. The heel of the gasket should fit uniformly into the retainer seat. On pipes larger than 12", additional loops may help in placing the gasket in the seating.

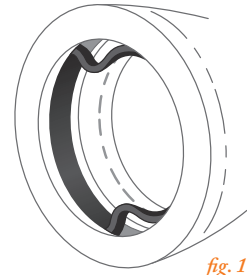

*fig. 1*

**FIG. 2 LUBRICATION**

Ensure that the spigot end is properly chamfered or rounded to avoid tearing of the gasket. Clean away all foreign matters from contact area of pipe. Apply a thin film of recommended lubricant to the mating surface of the gasket. Avoid spray-on lubricants as these may not provide enough lubrication. Avoid petroleum based lubricant as it may damage the gaskets. Once lubricated, do not let lubricated area touch the ground or other contaminant, compromised seal could result.

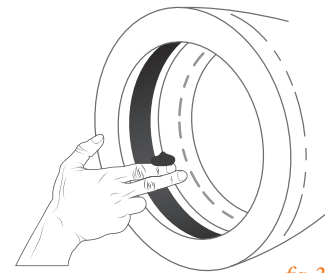

*fig. 2*

**FIG. 3 PIPE AND FITTING AND ASSEMBLY**

Spigot should be inserted in socket. If socket is pushed, the gasket may be displaced. Align and center the spigot in the socket and keep it in this position. Now gently push the spigot into the socket by suitable mechanical means, maintaining the alignment and level. A suitable gap should be left between the spigot end and the bottom of the socket to take care of any axial movement, deflection or temperature variation. To ensure this, two band marks are made near the spigot end. These bands act as a 'Go' and 'No-Go' gauge. After jointing, the end of the socket must end between these two bands. If moderate force does not result in a solid seal, remove the pipe and inspect for foreign matters, improper lubrication or misaligned gasket. Once you are certain of a solid seal, joint deflection can be applied within the permissible limits.

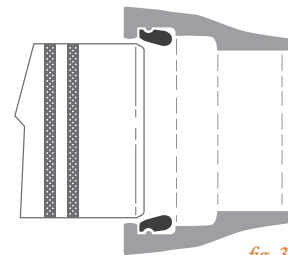

*fig. 3*

**FIG. 4 INSPECTION OF JOINT**

Verification of the gasket's position is easily accomplished with a feeler gauge. Insert the gauge into the joint until it touches the gasket. Check the gasket position all around the joint, making note of the depth required to contact the gasket. Any changes in depth indicate the gasket has slipped out of place. If this is the case, disassemble joint and clean all pipe contact areas and gasket. Once inspected for the fault, reassemble using the guidelines above.

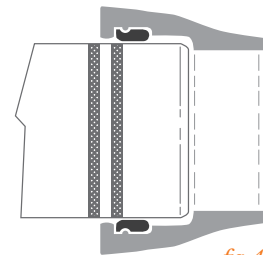

*fig. 4*





## **PUSH TITE** Ductile Iron Pipe

### ALTERNATE METHODS FOR ASSEMBLY

Electrosteel recommends following the procedures outlined in the previous section before attempting the alternatives listed below.

#### ASSEMBLY WITH A BACKHOE (for all DN)

Taking a few precautions, it is possible to use the hydraulic force of the arm of a mechanical digger to assemble pipes and straight fittings. In this case:

- Place a wooden batten between the pipe and digger bucket
- Exert a slow and steady force observing the rules for joint assembly
- A timber block should be placed between the bucket and the pipe to avoid damage of the socket.

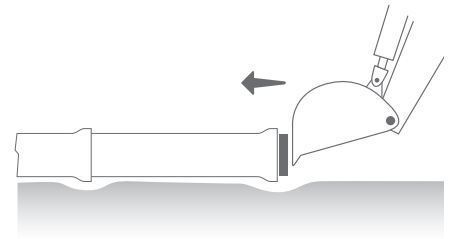

#### ASSEMBLY USING A CROWBAR

For smaller sizes (for 3" to 6" dia.) a crowbar may be used for assembly. This method involves using a crowbar as a lever and pushing against the face of the bell. The pipe socket face must be protected with a piece of hard wood.

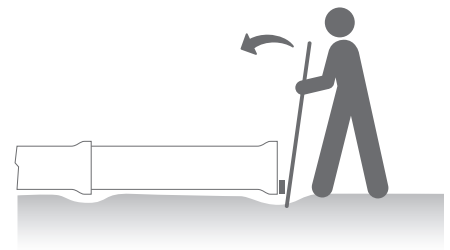



# PUSH TITE Ductile Iron Pipe

## ALTERNATE METHODS FOR ASSEMBLY | CONTINUED

### ASSEMBLY BY COME-ALONG

Installers may prefer to use come-alongs to assemble pipe of all sizes. This method requires two 2-ton chain hoists, 24 feet of chain and two bell choker slings for sizes from 3" to 24" in diameter.

Sometimes locations make the use of a backhoe impossible. Under those conditions assembly is best achieved with the following method.

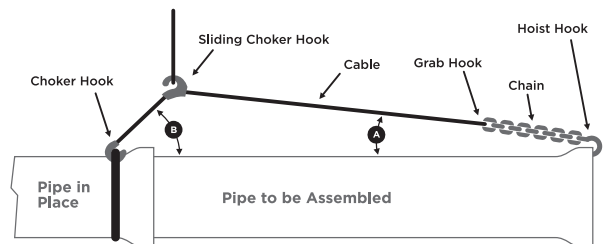

This procedure uses the weight of the pipe to provide the axial force required for assembly. Begin with spigot end of the pipe inserted as far as possible into the bell end of the previously laid pipe. Next, hook a choker chain or cable around the bell of the laid pipe. Then the choker is also hooked to the bell end of the pipe to be laid.

This configuration will result in a long cable with a choker on one end and a chain grab hook on the other end with a sliding choker hook between the two other hooks. An additional second section of the rigging has a shorter chain with a wide-throat hoisting hook on one end. The cable is then "choked" around the bell of the previously laid pipe using the fixed choker hook. Once accomplished, the chain is then hooked into the bell end of the pipe to be laid. This cable is hooked to the chain with the grab hook. The connected length of the rigging can now be adjusted with the connection made with the cable grab hook and the chain. Assembly is made by lifting up on the sliding choker hook.

- 6" to 12" dia. : Come-along or mechanical winches or chain pulley of capacity 1.6 ton, steel cable and rubber protected hooks.
- 14" to 24" dia. : Come-along or mechanical winches or chain pulley, capacity 3.5 ton, steel cable and rubber protected hooks.

**NOTE** This method should not be used with PushTite RJ Gaskets as alignment of the joint cannot be assured. For the proper installation practice, refer to PushTite RJ Gaskets brochure.

### TO EASE ASSEMBLY

1. Angle 'A' should be at 15° or less.
2. Angle 'B' should be from 45° to 60°.
3. The sliding choker hook should be located between 2 to 8 feet from the bell of the previously laid pipe.
4. Trial assembly helps with understanding the correct amount of slack to be left in the rigging and the correct location of the sliding choker hook.

### PRECAUTIONS

1. The smaller the angle 'A', the greater the assembly force and tension in the rigging. Assembly force and tension will usually range from 2 to 10 times the weight of the pipe being assembled. These forces reach their maximum when the assembly is bottomed out and lift is still being applied. To minimize the loads on the rigging, assembly should be made slowly then stopped once the joint has bottomed out.
2. The rigging should be able to accommodate the diameter, length, and weight of the pipe and the loads mentioned above.



## **PUSH TITE** Ductile Iron Pipe

### PREPARING A FIELD-CUT PIPE

Pipe that has been cut on site can easily be made ready for use by giving the plain end a bevel. With a portable grinder, create a 16° angle around the outside edge of the cut end. The edge of bevel and plain end of the pipe should be rounded off with the grinder. Grinding should produce a bevel that continues back about 1" from the edge. This bevel will ease assembly and protect the gasket from damage by removing rough edges.

Special consideration should be given to cutting pipe 14" or larger. In this case, pipe should be gauged full length.\* Pipe that is gauged full length will be marked as such and conforms to ANSI/AWWA C151 Standard for Ductile Iron Pipe requiring spigot end factory gauging.

To ensure tolerances, pipe for field cutting needs field gauging at the point of where the cut is to be made. Mechanical joint glands can be used for field gauging.

\* **NOTE** A full length gauged pipe is a pipe whose outside diameter is within the spigot diameter specifications. Full gauged pipes should be specially ordered.

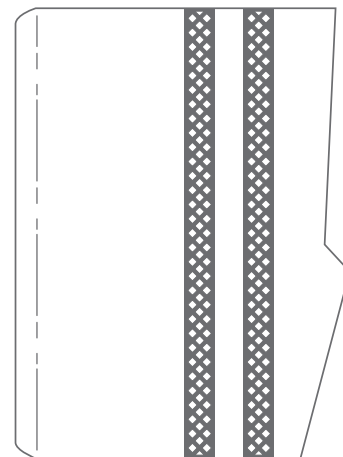
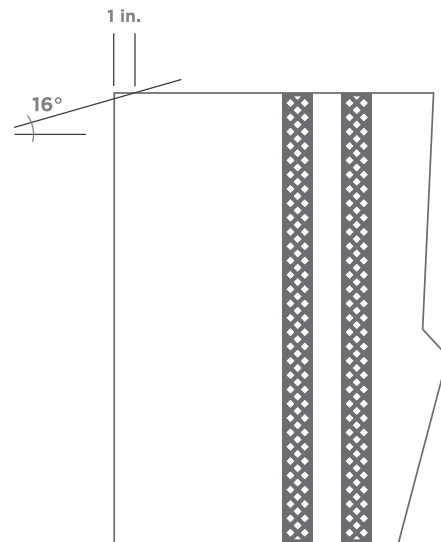



## **PUSH** **TITE** Ductile Iron Pipe

---

### **GASKET STORAGE**

The following precautions are to be taken for gasket storage, for conserving their properties and performance:

- Elastomers are sensitive to ultra-violet light and ozone. Stored gaskets must therefore be screened from light (direct sunlight and artificial light).
- Vulcanized elastomeric joint gaskets must be stored under clean and moderately humid conditions. The storage temperature must be below 25 °C.
- Gaskets should be stored in dry place at ambient temperature, avoiding direct exposure to sunlight.
- In freezing work conditions gaskets must not be deformed or stiffened at low temperature. Before use, their temperature must be brought up to about 20 °C over several hours (e.g. by immersion in tepid water). If stored in warm water, the gasket must be thoroughly dried before installation.
- Normal joint gaskets and flat gaskets stored under the above conditions can be safely used within a period of six years from manufacture date.





# PUSH TITE Ductile Iron Pipe

## ANGULAR DEFLECTION

Ductile iron socket and spigot push-on joint pipes permit angular deflection. In addition to the advantages during laying and the accommodation of ground movement, angular deflection allows the negotiation of large radius bends without recourse to fittings as well as a certain amount of route adjustment.

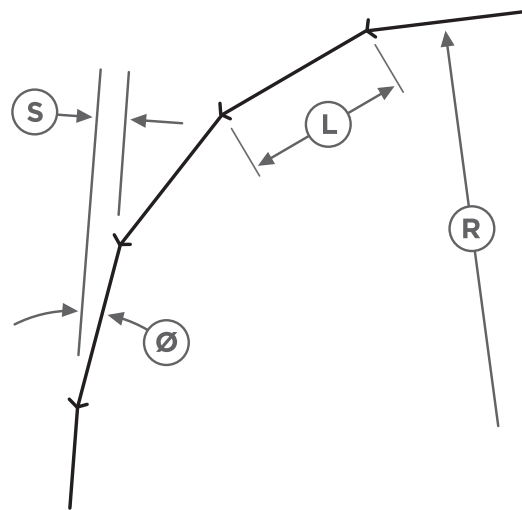

- Ø = deflection angle
- S = joint deflection offset
- L = laying length
- R = radius of curve

$$R = \frac{L}{2 \tan \frac{\varnothing}{2}}$$

## PERMISSIBLE DEFLECTION AFTER LAYING FOR PUSHTITE PIPES

DN (IN)	PERMISSIBLE DEFLECTION ANGLE Ø	BEND RADIUS R (FT)	DISPLACEMENT S (IN)	BEND RADIUS R (M)	DISPLACEMENT S (CM)
3 - 12	5°	205	19	62	48
14 - 24	5°	340	11	104	28

■ Pipe length is assumed as 5.5 mtr. or 18 ft.





# **PUSH TITE** Ductile Iron Pipe

## PIPE DIAMETERS | Suitable Pipe Diameters for Field Cuts and making Restrained Joints.

NOMINAL SIZE	DIAMETER MIN	DIAMETER MAX	CIRCUMFERENCE MIN	CIRCUMFERENCE MAX
3	3.90	4.02	12 - 1/4	12 - 5/8
4	4.74	4.86	14 - 29/32	15 - 9/32
6	6.84	6.96	21 - 1/2	21 - 7/8
8	8.99	9.11	28 - 1/4	28 - 5/8
10	11.04	11.16	34 - 11/16	35 - 1/16
12	13.14	13.26	41 - 9/32	41 - 21/32
14	15.22	15.35	47 - 13/16	48 - 7/32
16	17.32	17.45	54 - 13/32	54 - 13/16
18	19.42	19.55	61	61 - 13/32
20	21.52	21.65	67 - 19/32	68
24	25.72	25.85	80 - 13/16	81 - 7/32

■ ANSI/AWWA C151/A21.51 guidelines for push-on joints used in creating table. Dimensions in inches.



# PUSH TITE Ductile Iron Pipe

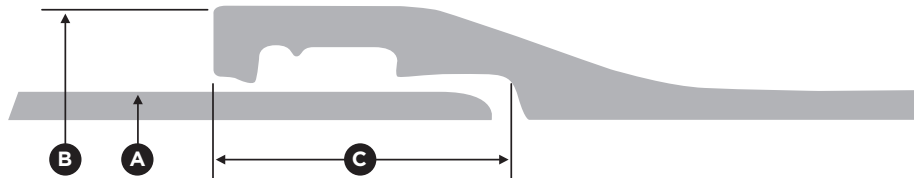

## BELL DIMENSIONS | Actual bell configuration may vary from illustration shown.

NOMINAL SIZE	A DIAMETER MINIMUM	A DIAMETER MAXIMUM	B BELL OUTER DIAMETER	C SOCKET DEPTH
3	3.90	4.02	5.80	3.00
4	4.74	4.86	6.86	3.15
6	6.84	6.96	8.75	3.38
8	8.99	9.11	11.05	3.69
10	11.04	11.16	13.15	3.75
12	13.14	13.26	15.30	3.75
14	15.22	15.35	17.85	5.00
16	17.32	17.45	20.00	5.00
18	19.42	19.55	22.10	5.00
20	21.52	21.65	24.25	5.50
24	25.72	25.85	28.50	5.95

■ ANSI/AWWA C151/A21.51 guidelines for push-on joints used in creating table. Subject to manufacturing tolerances. Dimensions in inches.





# PUSH TITE Ductile Iron Pipe

## PRESSURE CLASS | Nominal Thickness for Standard Pressure Classes of Ductile Iron Pipe

SIZE	OUTSIDE DIAMETER	NOMINAL THICKNESS   PRESSURE CLASS*				CASTING TOLERANCES
		200	250	300	350	
3	3.96	—	—	—	0.25**	0.05
4	4.80	—	—	—	0.25**	0.05
6	6.90	—	—	—	0.25**	0.05
8	9.05	—	—	—	0.25**	0.05
10	11.10	—	—	—	0.26	0.06
12	13.20	—	—	—	0.28	0.06
14	15.30	—	0.28	0.30	0.31	0.07
16	17.40	—	0.30	0.32	0.34	0.07
18	19.50	—	0.31	0.34	0.36	0.07
20	21.60	—	0.33	0.36	0.38	0.07
24	25.80	0.33	0.37	0.40	0.43	0.07

- Table above based on ANSI/AWWA C150/A21.50 and includes 0.08" service allowance and casting tolerance by size. Dimensions in inches.
- \* Pressure Classes determined by water pressure of the pipe measured in psi. Thicknesses rated to water pressure with additional 100 psi surge pressure. Calculations reflect minimum yield strength of 42,000 psi and 2.0 safety factor times the sum of the working pressure and 100 psi surge allowance.
- \*\* Calculated thickness less than shown above. These are the lowest nominal thicknesses available in these sizes.





# **PUSH TITE** Ductile Iron Pipe

## PRESSURE CLASS | Thickness, Dimensions & Weight

SIZE	PRESSURE CLASS psi	THICKNESS	OUTSIDE DIAMETER*	18 FT LAYING LENGTH	
				WEIGHT PER LENGTH (LBS)**	AVG WEIGHT PER FOOT (LBS)***
3	350	0.25	3.96	165	9.3
4	350	0.25	4.80	205	11.4
6	350	0.25	6.90	300	16.6
8	350	0.25	9.05	395	22.0
10	350	0.26	11.10	510	28.4
12	350	0.28	13.20	655	36.4
14	250	0.28	15.30	770	42.9
14	300	0.30	15.30	825	45.8
14	350	0.31	15.30	850	47.2
16	250	0.30	17.40	940	52.3
16	300	0.32	17.40	1000	55.5
16	350	0.34	17.40	1060	58.8
18	250	0.31	19.50	1090	60.5
18	300	0.34	19.50	1185	65.9
18	350	0.36	19.50	1250	69.5
20	250	0.33	21.60	1290	71.6
20	300	0.36	21.60	1395	77.6
20	350	0.38	21.60	1470	81.6
24	200	0.33	25.80	1550	86.1
24	250	0.37	25.80	1725	95.8
24	300	0.40	25.80	1855	103.0
24	350	0.43	25.80	1985	110.2

- Thicknesses and dimensions of 3" - 24" ductile iron pipe adhere to ANSI/AWWA C151/A21.51. Weights may vary due to slight variations in bell weights. Thickness and diameter in inches.
- Weight of pipes shall be as per the standard.
- \* Tolerance of O.D. of spigot end: 3-12 in., +/- 0.06 in.; 14-24 in., +0.05 in, -0.08 in.
- \*\* Calculated weight, including bell, of pipe rounded off to nearest 5 lbs.
- \*\*\* Average weight, per foot, based on calculated weight of pipe before rounding, including bell.





# PUSH TITE Ductile Iron Pipe

## THICKNESS CLASS | Thickness, Dimensions & Weight

SIZE	THICKNESS CLASS	THICKNESS	OUTSIDE DIAMETER*	18 FT LAYING LENGTH	
				WEIGHT PER LENGTH (LBS)**	AVG WEIGHT PER FOOT (LBS)***
3	51	0.25	3.96	165	9.3
3	52	0.28	3.96	185	10.3
3	53	0.31	3.96	205	11.3
3	54	0.34	3.96	220	12.2
3	55	0.37	3.96	235	13.2
3	56	0.40	3.96	255	14.1
4	51	0.26	4.80	210	11.8
4	52	0.29	4.80	235	13.1
4	53	0.32	4.80	255	14.3
4	54	0.35	4.80	280	15.5
4	55	0.38	4.80	300	16.6
4	56	0.41	4.80	320	17.8
6	50	0.25	6.90	300	16.6
6	51	0.28	6.90	330	18.4
6	52	0.31	6.90	365	20.2
6	53	0.34	6.90	395	22.0
6	54	0.37	6.90	430	23.8
8	50	0.27	9.05	425	23.7
8	51	0.30	9.05	470	26.1
8	52	0.33	9.05	515	28.6
8	53	0.36	9.05	560	31.0
8	54	0.39	9.05	600	33.4
8	55	0.42	9.05	645	35.7
8	56	0.45	9.05	685	38.1
10	50	0.29	11.10	565	31.4
10	51	0.32	11.10	620	34.5
10	52	0.35	11.10	675	37.5
10	53	0.38	11.10	730	40.5
10	54	0.41	11.10	780	43.4





# **PUSH TITE** Ductile Iron Pipe

## THICKNESS CLASS | Thickness, Dimensions & Weight | CONTINUED

SIZE	THICKNESS CLASS	THICKNESS	OUTSIDE DIAMETER*	18 FT LAYING LENGTH	
				WEIGHT PER LENGTH (LBS)**	AVG WEIGHT PER FOOT (LBS)***
12	50	0.31	13.20	720	40.0
12	51	0.34	13.20	785	43.6
12	52	0.37	13.20	850	47.2
12	53	0.40	13.20	915	50.8
12	54	0.43	13.20	980	54.4
12	55	0.46	13.20	1040	57.9
12	56	0.49	13.20	1105	61.5
14	50	0.33	15.30	900	50.0
14	51	0.36	15.30	975	54.2
14	52	0.39	15.30	1050	58.4
14	53	0.42	15.30	1125	62.6
14	54	0.45	15.30	1200	66.7
16	50	0.34	17.40	1060	58.8
16	51	0.37	17.40	1145	63.6
16	52	0.40	17.40	1230	68.4
16	53	0.43	17.40	1315	73.1
16	54	0.46	17.40	1400	77.9
16	55	0.49	17.40	1490	82.7
16	56	0.52	17.40	1575	87.4
18	50	0.35	19.50	1220	67.7
18	51	0.38	19.50	1315	73.1
18	52	0.41	19.50	1415	78.4
18	53	0.44	19.50	1510	83.9
18	54	0.47	19.50	1605	89.3
20	50	0.36	21.60	1395	77.6
20	51	0.39	21.60	1505	83.6
20	52	0.42	21.60	1615	89.6
20	53	0.45	21.60	1720	95.6
20	54	0.48	21.60	1830	101.6





# PUSH TITE Ductile Iron Pipe

## THICKNESS CLASS | Thickness, Dimensions & Weight | CONTINUED

SIZE	THICKNESS CLASS	THICKNESS	OUTSIDE DIAMETER*	18 FT LAYING LENGTH	
				WEIGHT PER LENGTH (LBS)**	AVG WEIGHT PER FOOT (LBS)***
24	50	0.38	25.80	1765	98.1
24	51	0.41	25.80	1895	105.4
24	52	0.44	25.80	2025	112.6
24	53	0.47	25.80	2155	119.7
24	54	0.50	25.80	2285	126.9
24	55	0.53	25.80	2415	134.1
24	56	0.56	25.80	2540	141.2

- Thicknesses and dimensions of 3" - 24" ductile iron pipe adhere to ANSI/AWWA C151/A21.51. Weights may vary due to slight variations in bell weights. Thickness and diameter in inches.
- Weight of pipes shall be as per the standard.
- \* Tolerance of O.D. of spigot end: 3-12 in., +/- 0.06 in.; 14-24 in., +0.05 in., -0.08 in.
- \*\* Calculated weight, including bell, of pipe rounded off to nearest 5 lbs.
- \*\*\* Average weight, per foot, based on calculated weight of pipe before rounding, including bell.







# **PUSH TITE** Ductile Iron Pipe

## MAXIMUM DEFLECTION | 18 Foot Length Pipe

SIZE	MAXIMUM JOINT DEFLECTION (DEG)	DEFLECTION (IN)	PRODUCED BY SUCCESSION OF JOINTS (FT)
3	5°	19	205
4	5°	19	205
6	5°	19	205
8	5°	19	205
10	5°	19	205
12	5°	19	205
14	5°	19	205
16	5°	19	205
18	5°	19	205
20	5°	19	205
24	5°	19	205





# **PUSH** **TITE** Ductile Iron Pipe

## PRODUCTS FOR WATER, WASTEWATER AND FIRE PROTECTION

DUCTILE IRON PIPE	SIZE RANGE
-------------------	------------

PushTite Pipe	3" - 24" Ductile Iron
Flanged Pipe	3" - 24" Ductile Iron

RESTRAINED JOINTS	SIZE RANGE
-------------------	------------

PushTite RJ Gaskets	4" - 24" Ductile Iron
---------------------	-----------------------

DUCTILE IRON FITTINGS	SIZE RANGE
-----------------------	------------

PushTite MJ Fittings	3" - 24" Ductile Iron
----------------------	-----------------------

**NOTE** Consistency and quality are Electrosteel's guiding principles. All PushTite products conform to National Standards. Non-Electrosteel components that do not comply with set standards can compromise performance and longevity.



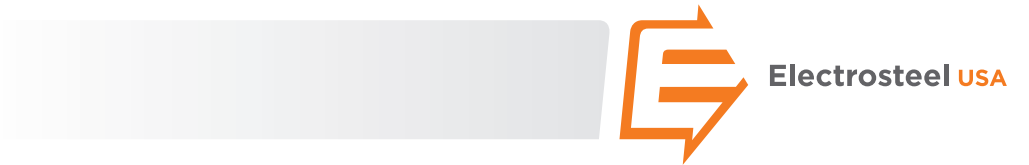

270 Doug Baker Blvd

Suite 700-291

Birmingham, AL 35242

[support@ElectrosteelUSA.com](mailto:support@ElectrosteelUSA.com)

205.637.3370 **P**

205.408.9983 **F**

