

100% manufactured from raw materials to provide the best cooking experience, a high standard of quality, and the highest durability in its class to meet the needs of a commercial kitchen.

CONSULTANT / CONTRACTOR NOTES:



Countertop Thermostatic Gas Griddle **FGTG36**

Standard Features:

GRIDDLE

- Available in 24" (610mm), 36" (915mm), 48" (1,220mm), and 60" (1,525mm) width.
- Stainless steel panel and sides.
- 14" gauge polished stainless steel construction.
- 3/4" thick polished carbon steel working griddle plate.
- Fully welded griddle plate.
- Enameled burners placed every 12", providing uniformity when operating.
- 200°F - 575°F Energy-saving adjustable thermostat to control desired griddle plate surface temperature.
- Accessible pilots through front panel.
- Chrome plated injected aluminum knobs providing for better toughness and durability.
- 1-year parts and labor warranty.
- 4" adjustable chromed carbon steel legs.
- Easily removable stainless steel griddle grease trap.
- Griddle grease trap capacity: 1.74 gal

FGTG36

Countertop Thermostatic Gas Griddle

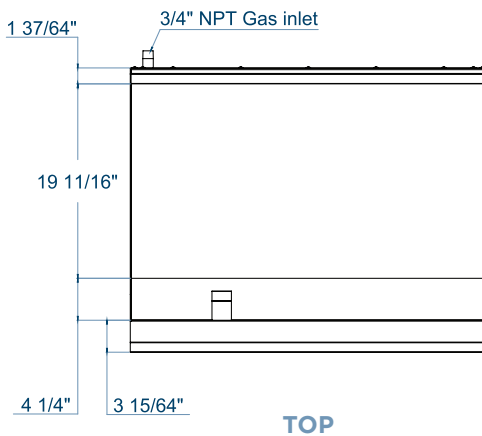
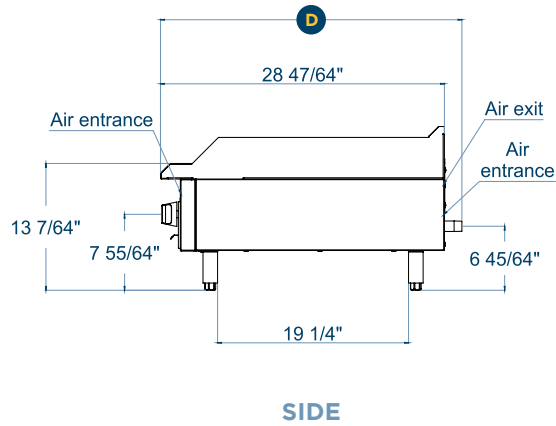
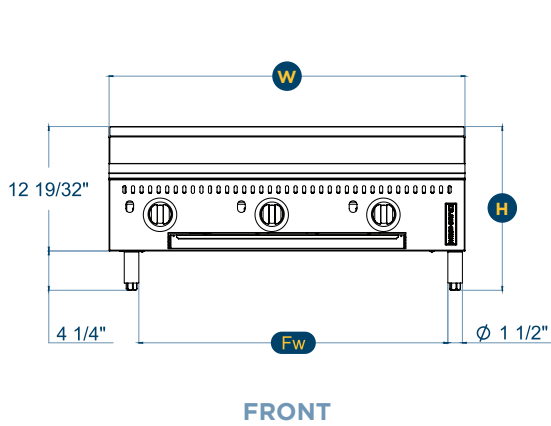

SPECIFICATIONS

- 35,000 BTU/h burners placed every 12", providing best performance.
- Manifold pressure is 4" W.C. (Natural Gas) or 10" W.C. (Propane Gas).
- 3/4" NPT rear gas connection and pressure regulator for both natural gas and propane.
- Check the altitude specifications above 2,000 ft.

Model	Exterior Product Dimensions & Weight					Shipping Crate Dimensions & Weight			
	Width (W)	Depth (D)	Height (H)	Fw	Weight	Width	Depth	Height	Weight
FGTG36	36"	30 33/64"	16 27/32"	31 9/32"	234 lb	40 5/32"	34 1/4"	19 19/64"	282 lb

UTILITY INFORMATION

GAS SUPPLY							
MODEL	BURNERS	PROPANE		NATURAL		MANIFOLD PRESSURE	
		kcal/h	BTU/h	kcal/h	BTU/h	Natural Gas	Propane Gas
FGTG36	3	26,460	105,000	26,460	105,000	4" W.C	10" W.C

INSTALLATION INSTRUCTIONS

A pressure regulator sized for this unit is included. The gas line connecting to the range must be 3/4" or larger. If flexible connectors are used, the inside diameter must be 3/4" or larger. An adequate ventilation system is required for commercial cooking equipment. Information may be obtained by writing to the National Fire Protection Association, 1 Batterymarch Park, Quincy, MA 02269, www.NFPA.org. When writing, refer to NFPA No. 96.4. These units are manufactured for installation in accordance with ANSZ223.1A (latest edition), National Fuel Gas Code. Copies may be obtained from The American Gas Association, 400 N Capitol St. NW, Washington, DC 20001, www.AGA.org

***NOTE:** In line with its policy to continually improve its product, Fortress™ reserves the right to change materials and specifications without notice.

- Specify altitude when above 2,000 feet.