

BOMBA CENTRÍFUGA EN ACERO INOXIDABLE

Serie **SOX**
1.5 - 50 HP



SUCCIÓN

2", 2½", 3" y 4" horizontal bridada 150 lb DIN.

DESCARGA

1¼", 1½", 2", 2½" y 3" vertical bridada 150 lb DIN.

TEMPERATURA MÁXIMA DEL LÍQUIDO

70 °C (158 °F); con sello para alta temperatura, se eleva a 104 °C (219 °F).

MÁXIMA PRESIÓN DE TRABAJO

145 PSI (10.2 kg/cm²).

CUERPO

Acero inoxidable 304.

PLATO DEL SELLO

Acero inoxidable 304.

IMPULSOR

Diseño: tipo cerrado.

Material: acero inoxidable 304.

SELLO

Diseño: mecánico, lubricado por agua.

Material: cerámica parte estacionaria, anillo de carbón y sello de exclusión parte rotatoria, elastómero de Buna-N y resorte de acero inoxidable.

ACOPLAMIENTO

Hierro gris ASTM, clase 30.

TORNILLERÍA

Acero inoxidable 304.

EMPAQUES

Forma "O" de Buna-N.

MANGA DE FLECHA

Acero inoxidable 316.

MOTOR

Alta eficiencia, totalmente cerrado con ventilación exterior; 60 Hz, 3450 RPM, monofásico de 230 volts y trifásico de 230/460 volts, aislamiento clase F. Protección térmica incorporada en equipos monofásicos.

Requiere instalación de protección eléctrica por sobrecarga.

EQUIPAMIENTO OPCIONAL

Contrabridas con rosca NPT tipo DIN en acero inoxidable 304. Incluye tornillería y empaques.

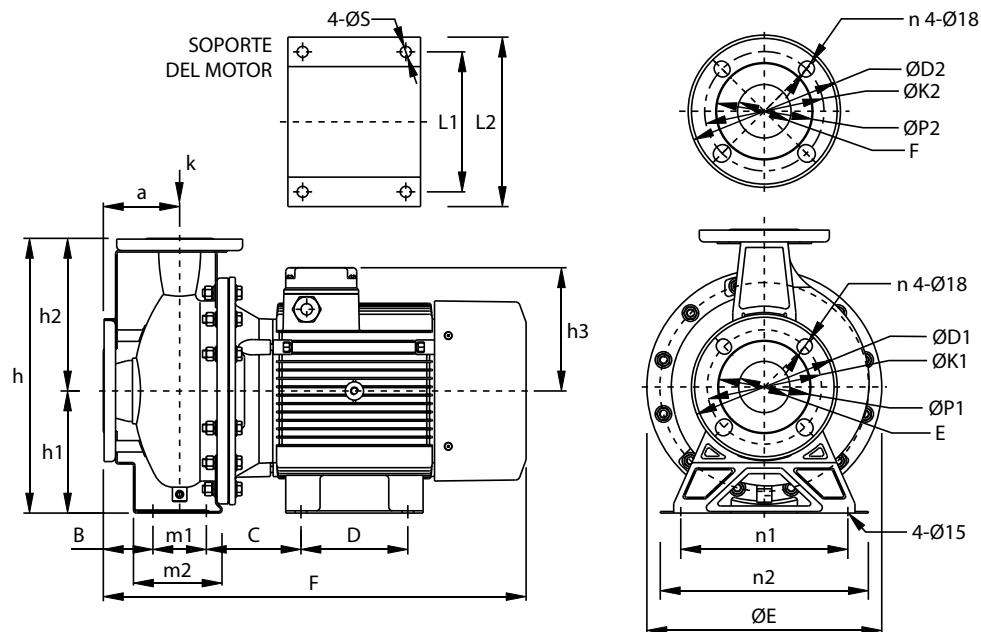

MODELO	HP	TAMAÑO	DIMENSIONES (mm)																											
			E	F	H	h1	h2	h3	a	m1	m2	n1	n2	B	C	D	S	L1	L2	D1	k1	P1	D2	k2	P2	n				
SOX1¼-1.5-2-1	1.5	2" x 1¼"	210	395	255	112	143	134	80	70	115	160	190	45	95	90	12	125	155	165	125	96	140	100	76	4				
SOX1¼-1.5-2	1.5	2" x 1¼"	210	395	255	112	143	134	80	70	115	160	190	45	95	90	12	125	155	165	125	96	140	100	76	4				
SOX1¼-2-2-1	2	2" x 1¼"	210	395	255	112	143	134	80	70	115	160	190	45	95	90	12	125	155	165	125	96	140	100	76	4				
SOX1¼-2-2	2	2" x 1¼"	210	395	255	112	143	134	80	70	115	160	190	45	95	90	12	125	155	165	125	96	140	100	76	4				
SOX1¼-3-2	3	2" x 1¼"	210	428	255	112	143	119	80	70	115	160	190	45	111	100	12	160	190	165	125	96	140	100	76	4				
SOX1¼-4-2	4	2" x 1¼"	300	460	340	160	180	119	80	70	118	190	240	45	109	100	12	160	190	165	125	96	140	100	76	4				
SOX1¼-5.5-2	5.5	2" x 1¼"	300	520	340	160	180	162	80	70	118	190	240	45	122	140	15	190	225	165	125	96	140	100	76	4				
SOX1¼-7.5-2	7.5	2" x 1¼"	300	593	340	160	180	182	80	70	118	190	240	45	161	140	15	216	255	165	125	96	140	100	76	4				
SOX1½-2-2-1	2	2½" x 1½"	210	395	255	112	143	134	80	70	115	160	190	45	95	90	12	125	155	185	145	115	150	110	80	4				
SOX1½-2-2	2	2½" x 1½"	210	395	255	112	143	134	80	70	115	160	190	45	95	90	12	125	155	185	145	115	150	110	80	4				
SOX1½-3-2-1	3	2½" x 1½"	210	425	255	112	143	119	80	70	115	160	190	45	111	100	12	160	190	185	145	115	150	110	80	4				
SOX1½-3-2	3	2½" x 1½"	210	425	255	112	143	119	80	70	115	160	190	45	111	100	12	160	190	185	145	115	150	110	80	4				
SOX1½-4-2	4	2½" x 1½"	250	460	292	132	160	119	80	70	118	190	240	45	111	100	12	160	190	185	145	115	150	110	80	4				
SOX1½-5.5-2	5.5	2½" x 1½"	250	520	292	132	160	162	80	70	118	190	240	45	148	140	15	190	230	185	145	115	150	110	80	4				
SOX1½-7.5-2	7.5	2½" x 1½"	300	615	360	160	200	182	100	70	118	212	264	65	161	140	15	216	255	185	145	115	150	110	80	4				
SOX1½-10-2	10	2½" x 1½"	300	615	360	160	200	182	100	70	118	212	264	65	161	140	15	216	255	185	145	115	150	110	80	4				
SOX1½-15-2	15	2½" x 1½"	350	671	360	160	200	155	100	70	118	212	264	65	147	210	15	254	320	185	145	115	150	110	80	4				
SOX2-4-2	4	2½" x 2"	250	455	292	132	160	119	80	70	115	190	240	45	110	100	12	160	190	185	145	115	165	125	96	4				
SOX2-5.5-2	5.5	2½" x 2"	250	520	292	132	160	162	80	70	115	190	240	45	148	140	15	190	230	185	145	115	165	125	96	4				
SOX2-7.5-2	7.5	2½" x 2"	300	615	360	160	200	182	100	70	118	212	264	65	161	140	15	216	255	185	145	115	165	125	96	4				
SOX2-10-2	10	2½" x 2"	300	615	360	160	200	182	100	70	118	212	264	65	161	140	15	216	255	185	145	115	165	125	96	4				
SOX2-12.5-2	12.5	2½" x 2"	300	617	360	160	200	182	100	70	118	212	264	65	161	140	15	216	255	185	145	115	165	125	96	4				
SOX2-15-2	15	2½" x 2"	350	671	360	160	200	255	100	70	118	212	264	65	147	210	15	254	320	185	145	115	165	125	96	4				
SOX2-20-2	20	2½" x 2"	350	671	360	160	200	255	100	70	118	212	264	65	147	210	15	254	320	185	145	115	165	125	96	4				
SOX2-25-2	25	2½" x 2"	350	715	360	160	200	255	100	70	118	212	264	65	147	254	15	254	320	185	145	115	165	125	96	4				
SOX2½-5.5-2	5.5	3" x 2½"	256	534	340	160	180	162	100	95	152	212	250	53	113	140	15	190	230	200	160	132	185	145	115	4				
SOX2½-7.5-2	7.5	3" x 2½"	256	636	340	160	180	179	100	95	152	212	250	53	175	140	15	216	255	200	160	132	185	145	115	4				
SOX2½-10-2	10	3" x 2½"	256	636	340	160	180	179	100	95	152	212	250	53	175	140	15	216	255	200	160	132	185	145	115	4				
SOX2½-12.5-2	12.5	3" x 2½"	256	636	340	160	180	179	100	95	152	212	250	53	175	140	15	216	255	200	160	132	185	145	115	4				
SOX2½-15-2	15	3" x 2½"	350	705	360	160	200	255	100	95	152	212	250	53	140	210	15	254	320	200	160	132	185	145	115	4				
SOX2½-20-2	20	3" x 2½"	350	705	292	160	200	255	100	95	152	212	250	53	140	210	15	254	320	200	160	132	185	145	115	4				
SOX2½-25-2	25	3" x 2½"	350	748	405	180	225	255	100	95	148	250	290	53	456	-	15	254	320	200	160	132	185	145	115	4				
SOX2½-30-2	30	3" x 2½"	356	776	405	180	225	275	100	95	148	250	290	53	169	241	15	279	355	200	160	132	185	145	115	4				
SOX2½-40-2	40	3" x 2½"	400	844	425	200	225	308	100	95	148	250	290	53	177	305	19	318	386	200	160	132	185	145	115	4				
SOX3-15-2	15	4" x 3"	350	725	405	180	225	255	125	95	176	250	290	78	452	140	15	254	320	220	180	152	200	160	132	8				
SOX3-20-2	20	4" x 3"	350	725	405	180	225	255	125	95	176	250	290	78	452	140	15	254	320	220	180	152	200	160	132	8				
SOX3-25-2	25	4" x 3"	350	769	405	180	225	255	125	95	176	250	290	78	452	-	15	254	320	220	180	152	200	160	132	8				
SOX3-30-2	30	4" x 3"	356	811	430	180	250	275	125	95	176	280	320	78	180	241	15	279	355	220	180	152	200	160	132	8				
SOX3-40-2	40	4" x 3"	400	880	450	200	250	308	125	95	176	280	320	78	188	305	19	318	386	220	180	152	200	160	132	8				
SOX3-50-2	50	4" x 3"	400	880	450	200	250	308	125	95	176	280	320	78	188	305	19	318	386	220	180	152	200	160	132	8				

Barnes de México, S.A. de C.V.

D. Ladrón de Guevara 302 ote.
C.P. 64500 Monterrey N.L. México
Tel. (81) 8863.3737 / (81) 8351.3737
Fax. (81) 8331.1777 / (81) 8351.9609

ventas@barnes.com.mx

www.barnesa.com.mx

¡IMPORTANTE!

1. No utilice la bomba para bombear líquidos explosivos ni corrosivos.

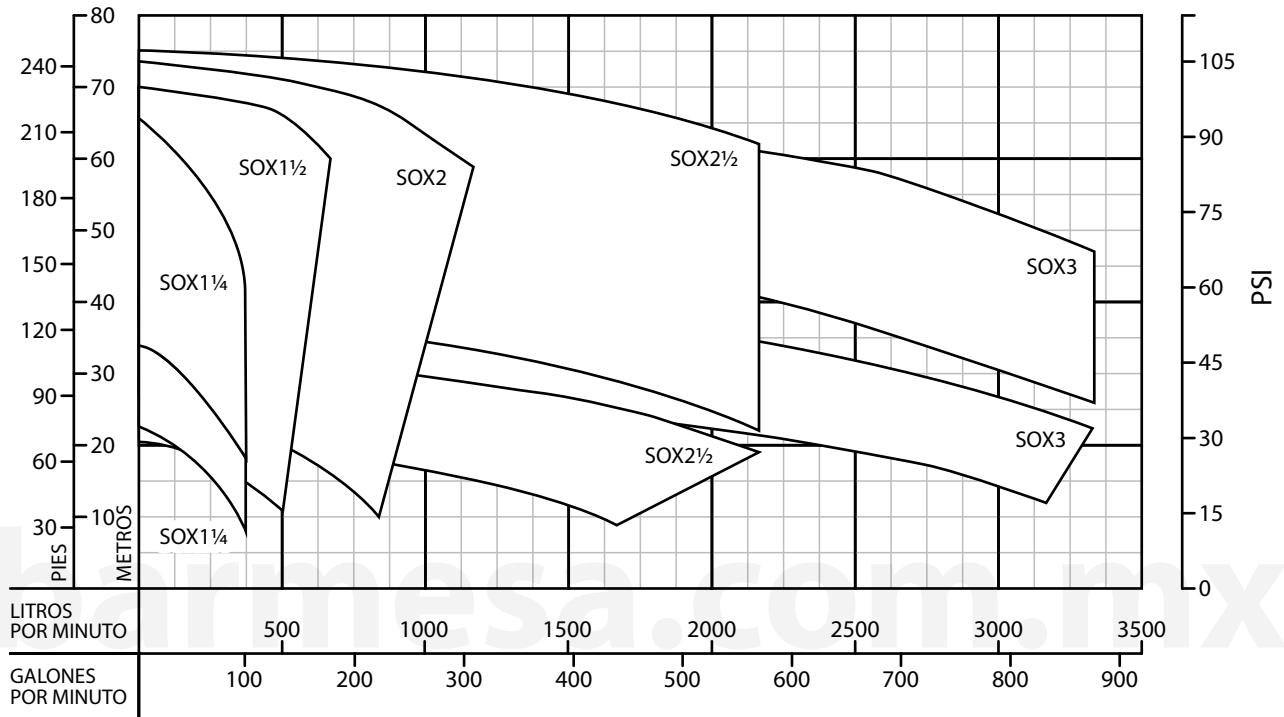

SERIE	RANGO DE POTENCIA	CAUDAL NOMINAL		RANGO DE OPERACIÓN	
	HP	LPS	GPM	LPS	GPM
SOX1¼	1.5 - 3	4	63	1 - 6	13 - 95
SOX1¼	4 - 7.5	5	79	1 - 6	13 - 98
SOX1½	2 - 15	7	111	1 - 10	21 - 159
SOX2	4 - 25	12	190	3 - 17	48 - 263
SOX2½	5.5 - 12.5	24	380	11 - 33	171 - 528
SOX2½	15 - 40	28	444	11 - 36	171 - 567
SOX3	15 - 25	38	602	17 - 55	263 - 872
SOX3	30 - 50	44	697	17 - 55	263 - 872

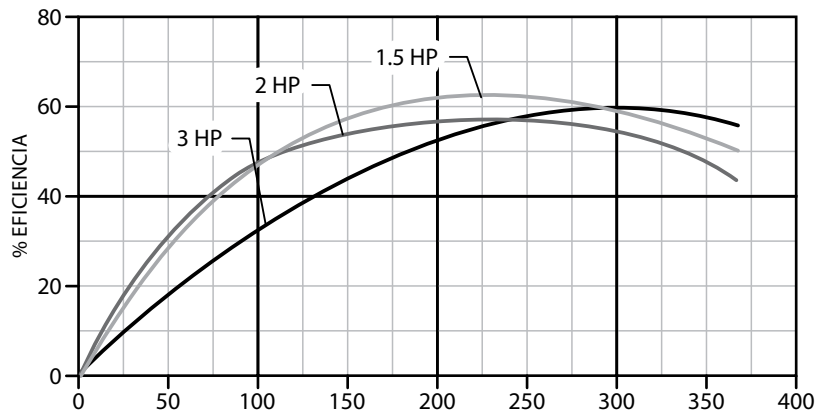
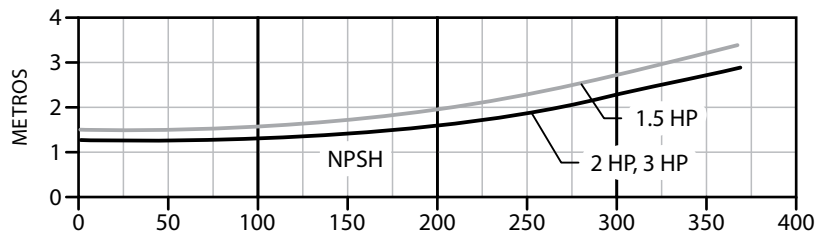
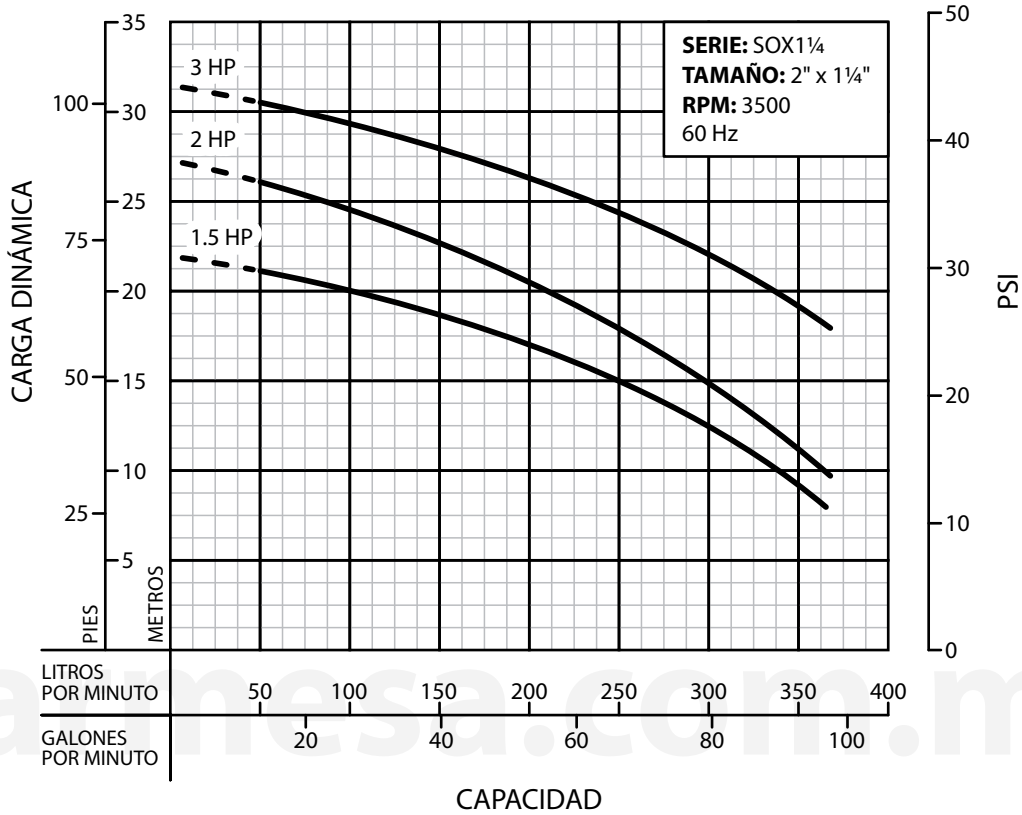

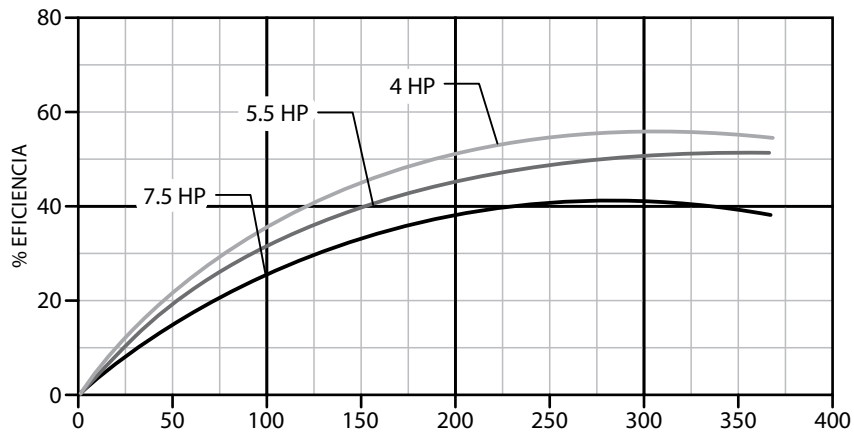
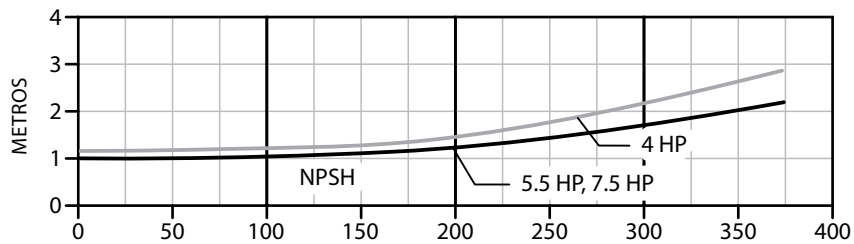
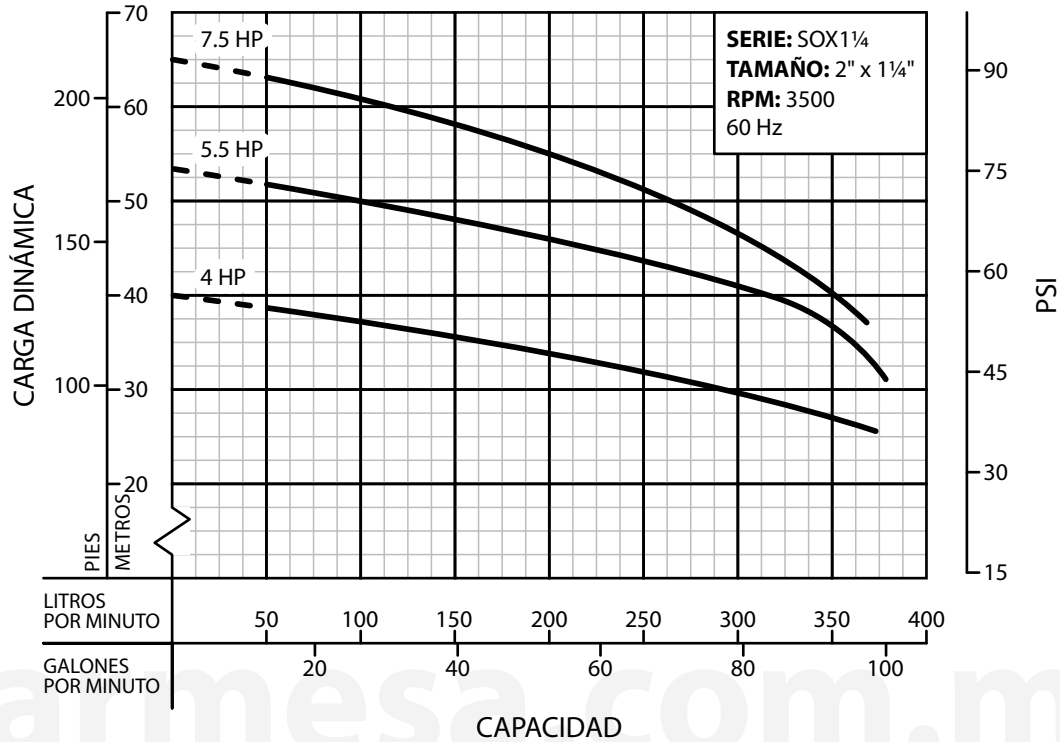

Barnes de México, S.A. de C.V.
D. Ladrón de Guevara 302 ote. C.P. 64500 Monterrey N.L. México
(81) 8863-3737 • (81) 8351-3737 • fax (81) 8331-1777
ventas@barnes.com.mx
www.barmesa.com.mx

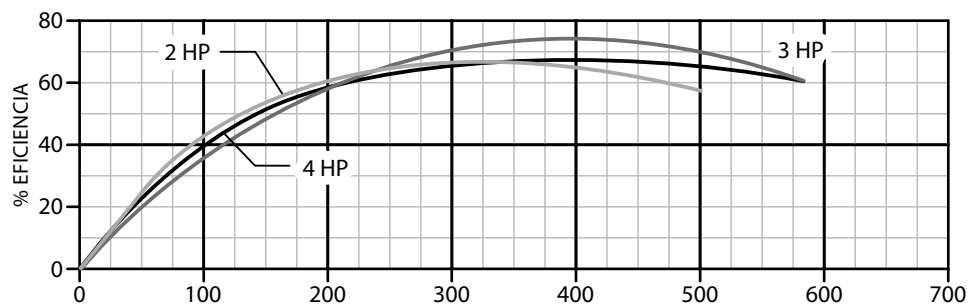
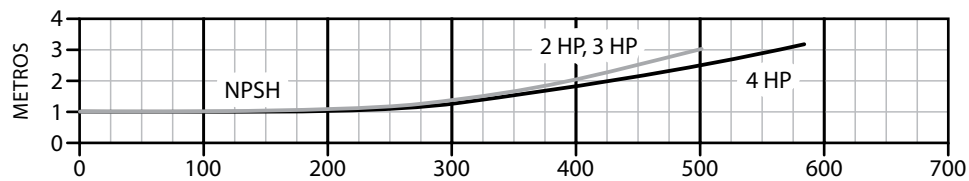
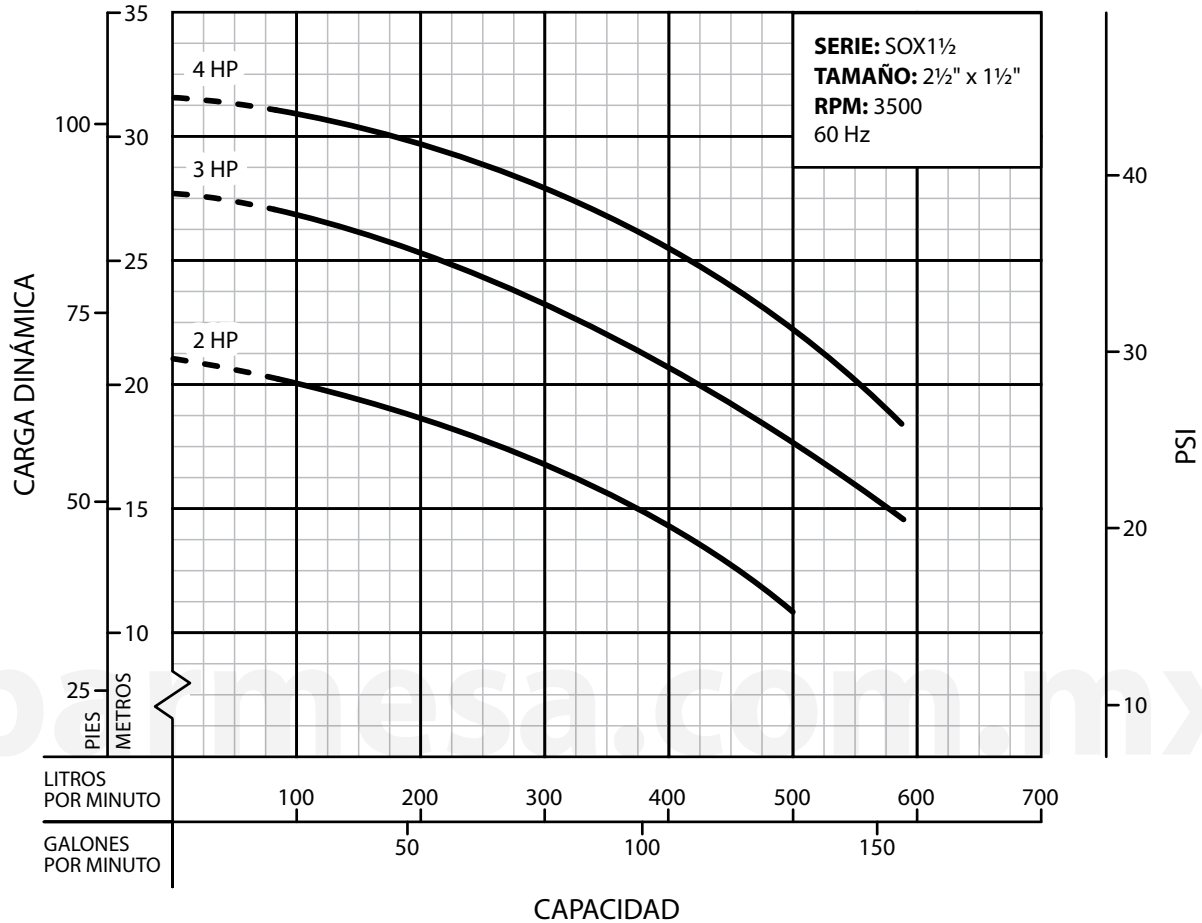

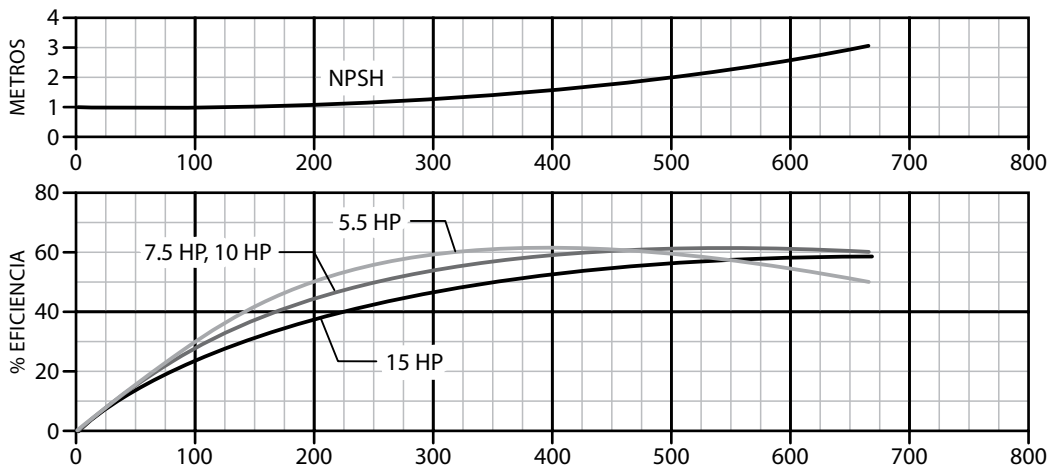
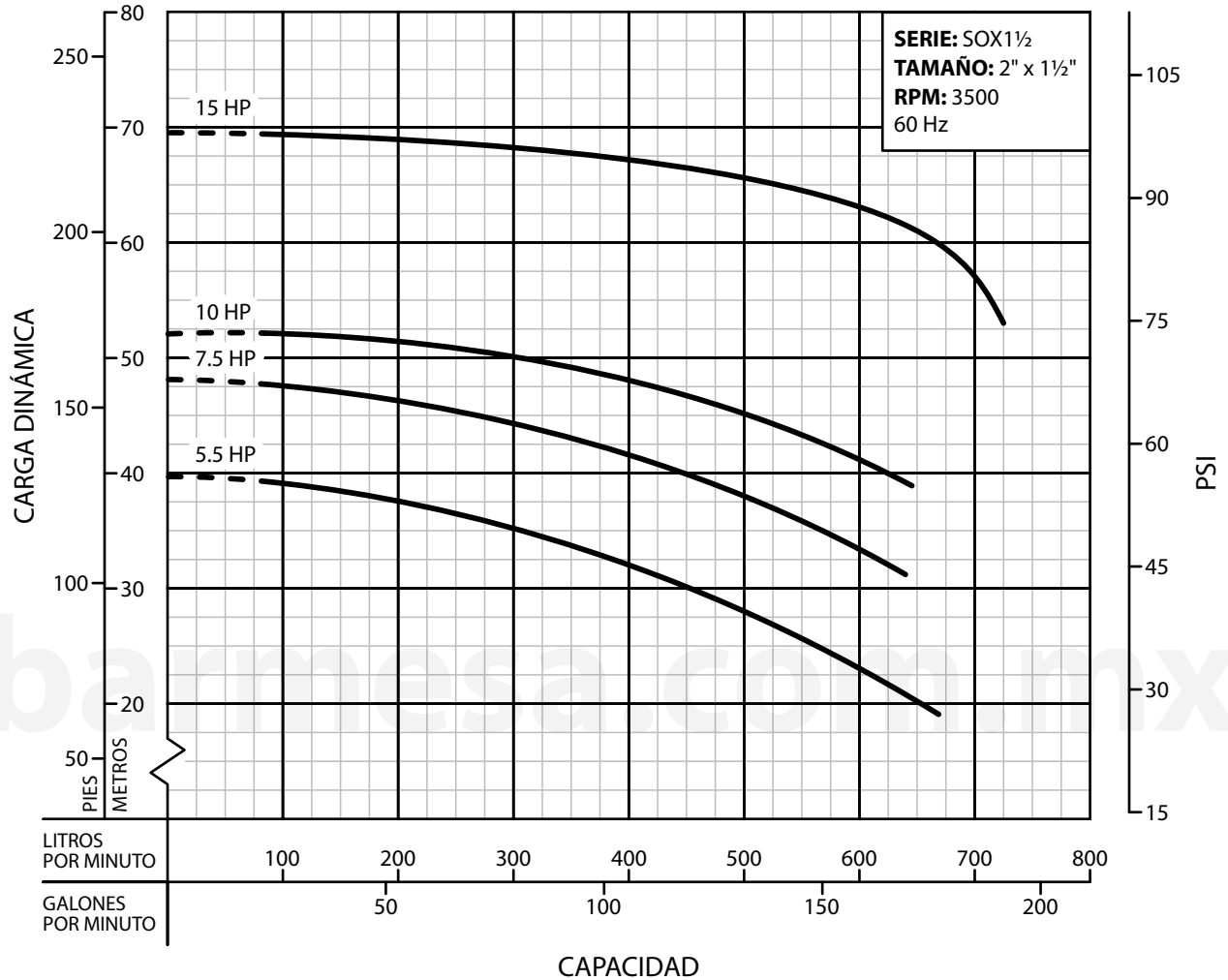

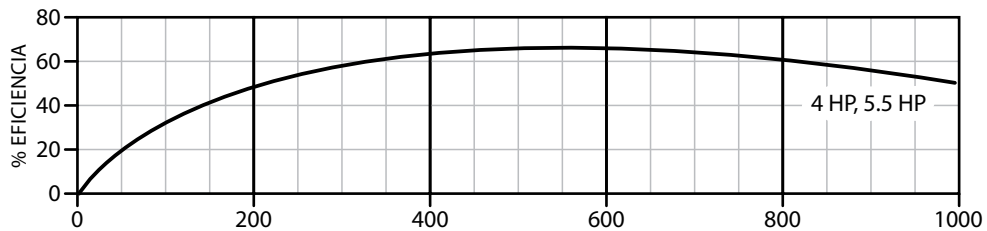
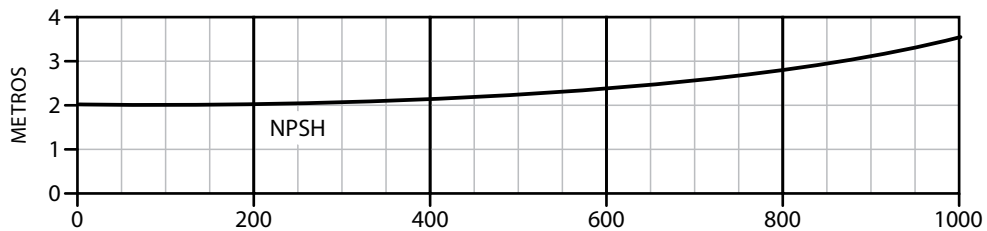
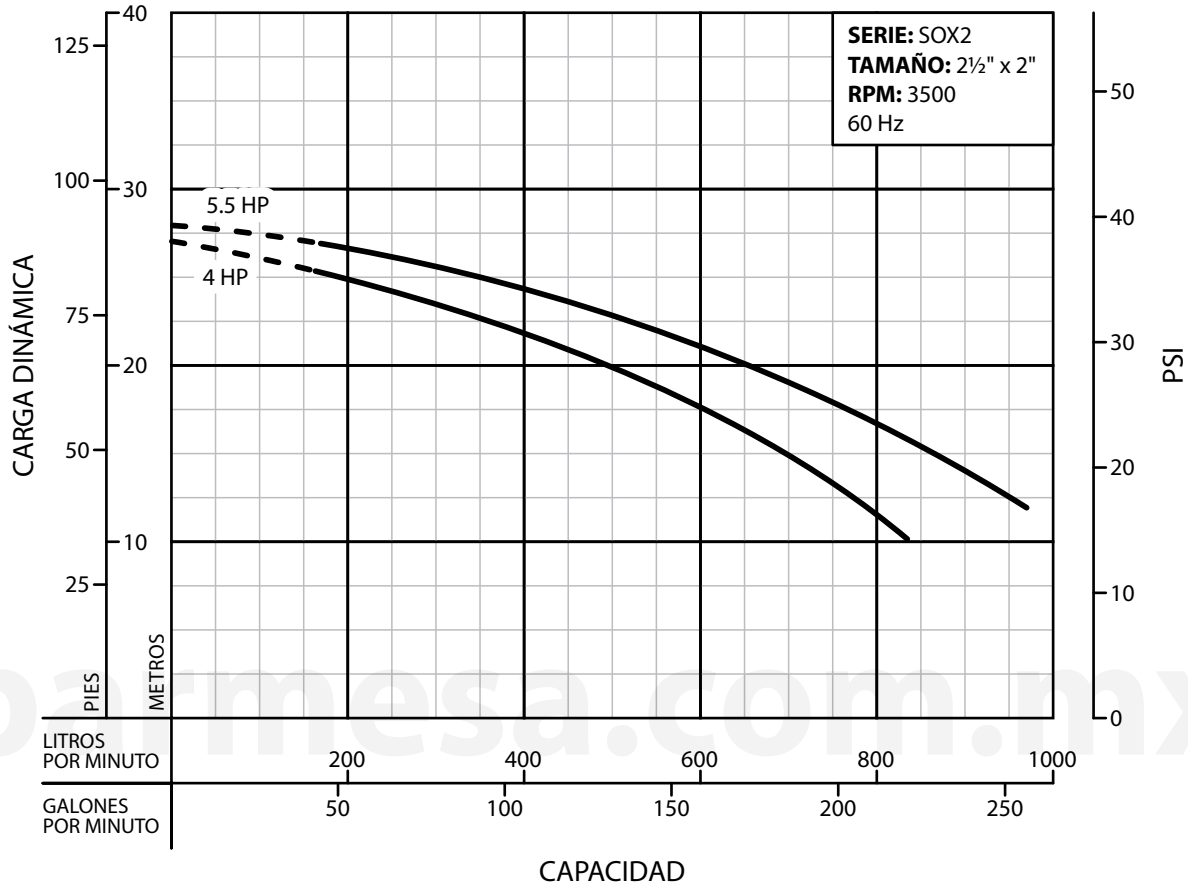

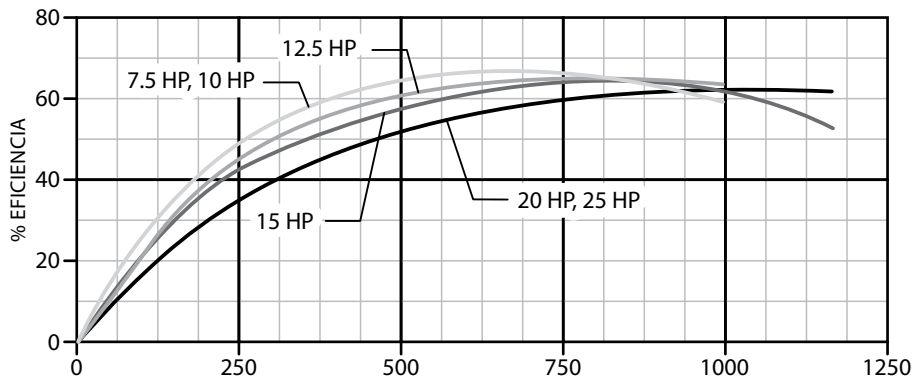
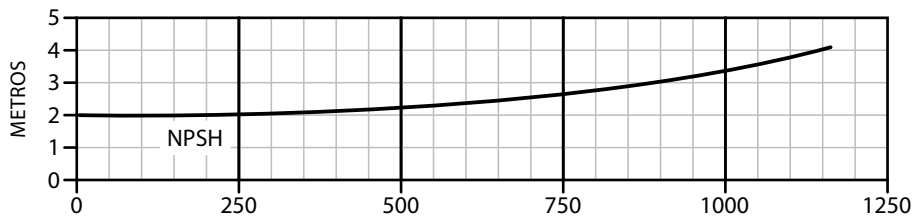
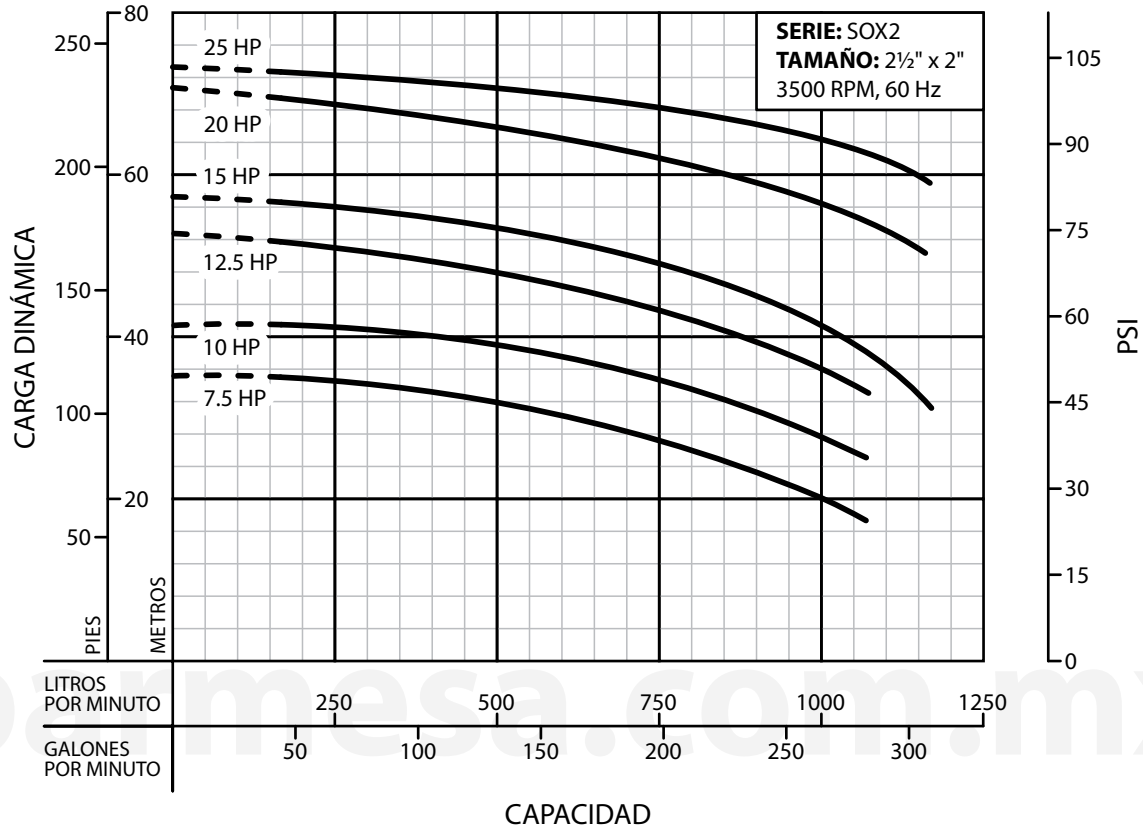

Barnes de México, S.A. de C.V.
D. Ladrón de Guevara 302 ote. C.P. 64500 Monterrey N.L. México
(81) 8863-3737 • (81) 8351-3737 • fax (81) 8331-1777
ventas@barnes.com.mx
www.barmesa.com.mx

