

DWG NO	Enclosure Assembly	SH	1	REV		
REVISION HISTORY						
ZONE	REV	DESCRIPTION			DATE	APPROVED

ALL SHEETS SAME REV

NOTES: UNLESS OTHERWISE SPECIFIED

1. APPLICABLE STANDARDS/SPECIFICATIONS:  
INTERPRET DRAWING IAW ASME Y14.100-2017.  
DIMENSIONING AND TOLERANCING IAW ASME Y14.5-2009.
2. MATERIAL: 3/4 INCH FINISHED PLYWOOD

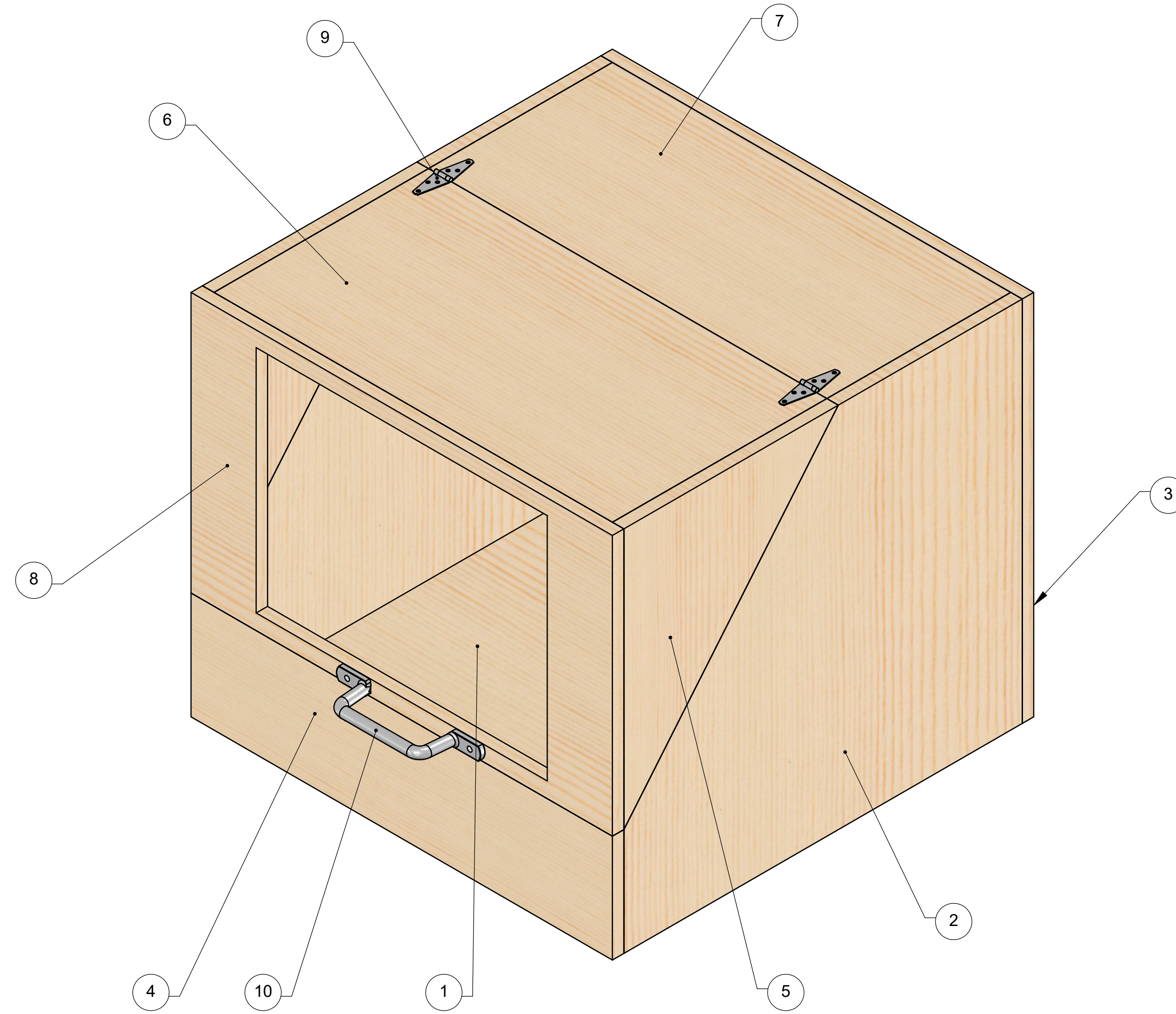

ISOMETRIC VIEW  
FOR REFERENCE ONLY

ITEM NO.	CUT LIST	QTY.
1	Base	1
2	Side	2
3	Back	1
4	Front	1
5	Angle Block	2
6	Lid Top	1
7	Base Top	1
8	Window Plate	1
9	Hinge	2
10	Pull Handle	1

UNLESS OTHERWISE SPECIFIED DIM ARE IN INCHES TOL ON ANGLE ±° 1 PL ± 2 PL ± 3 PL ± DO NOT SCALE DRAWING THIRD ANGLE PROJECTION		CONTRACT NO		<b>CLACK SHACK ENCLOSURE FOR XTOOL D1</b>		
NEXT ASSY		APPROVED				DATE
USED ON		DRAWN				CHECKED
APPLICATION				DWG. NO. Enclosure Assembly SCALE 1:8 CALC MASS 33.634 LBS SHEET 1 of 3		

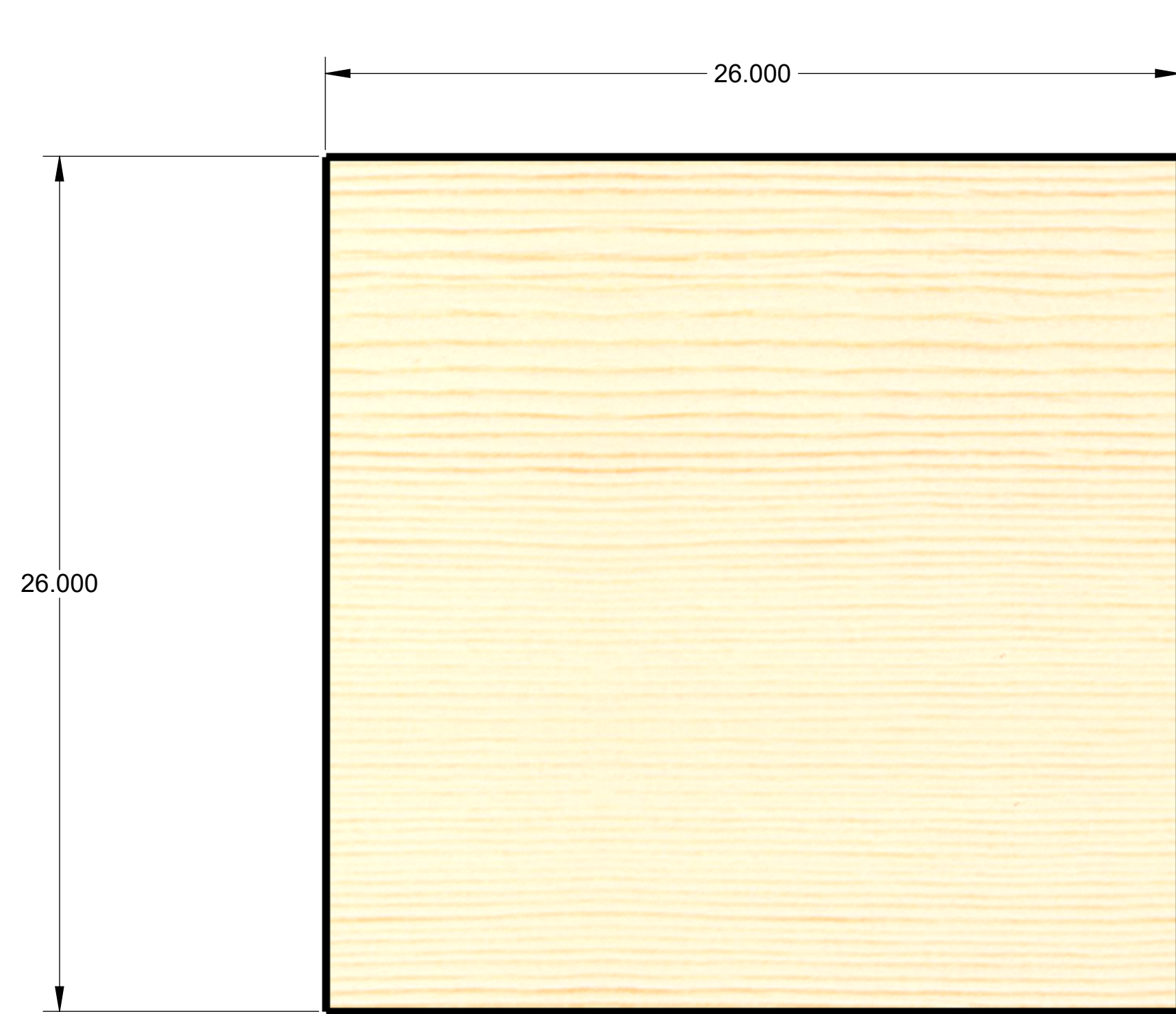

**BASE**  
ITEM 1  
QTY 1

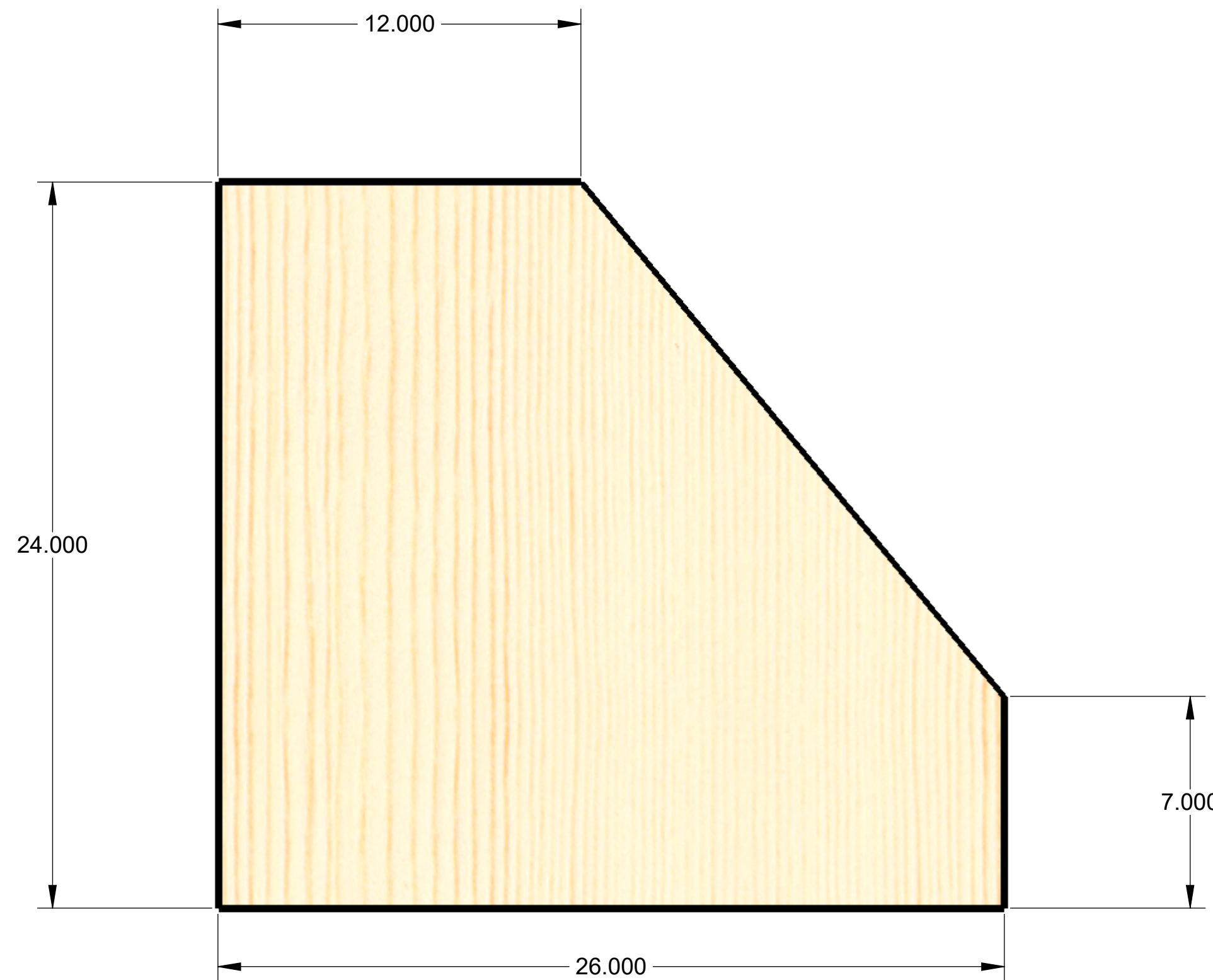

**SIDE**  
ITEM 2  
QTY 2

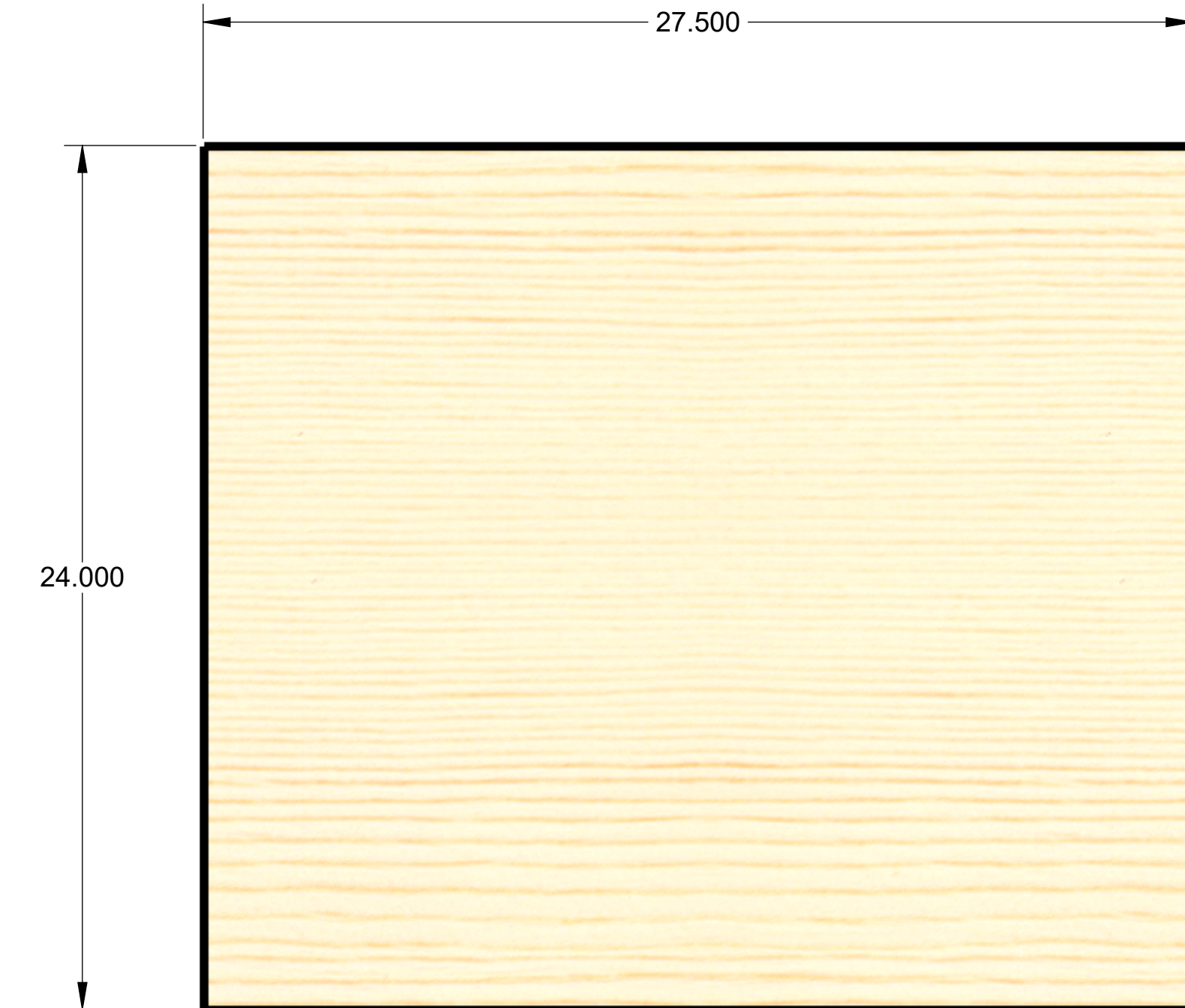

**BACK**  
ITEM 3  
QTY 1

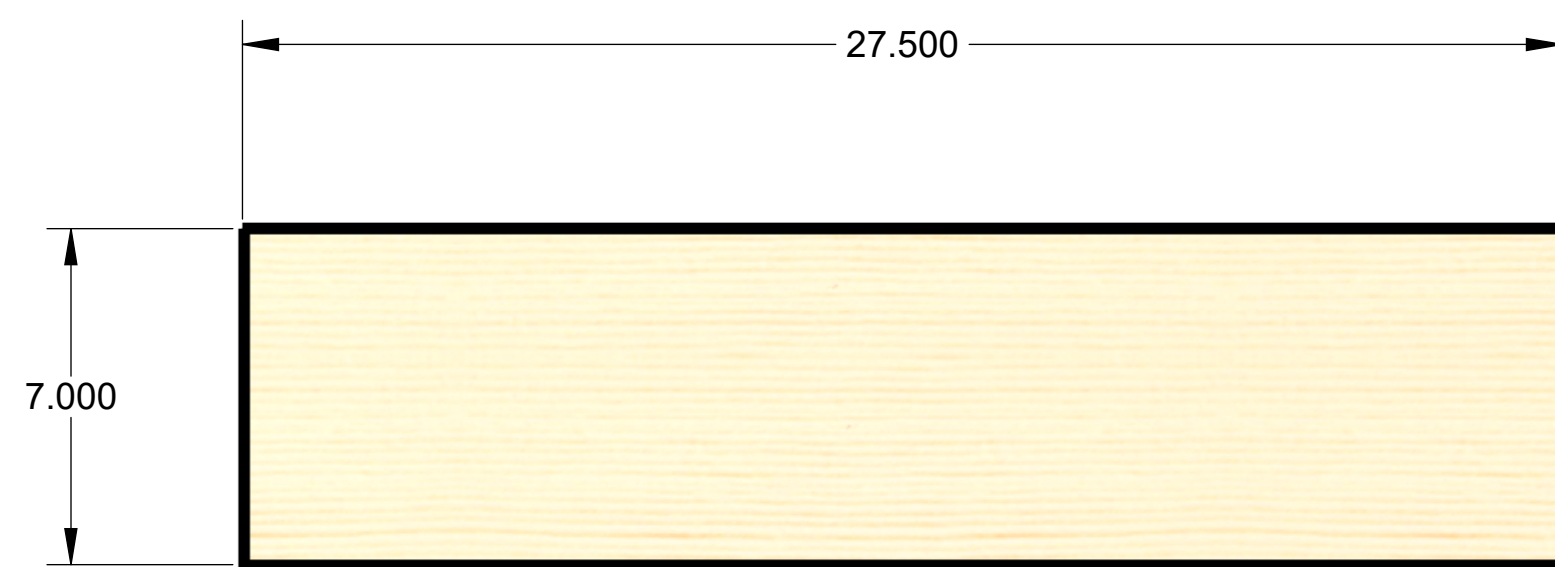

**FRONT**  
ITEM 4  
QTY 1

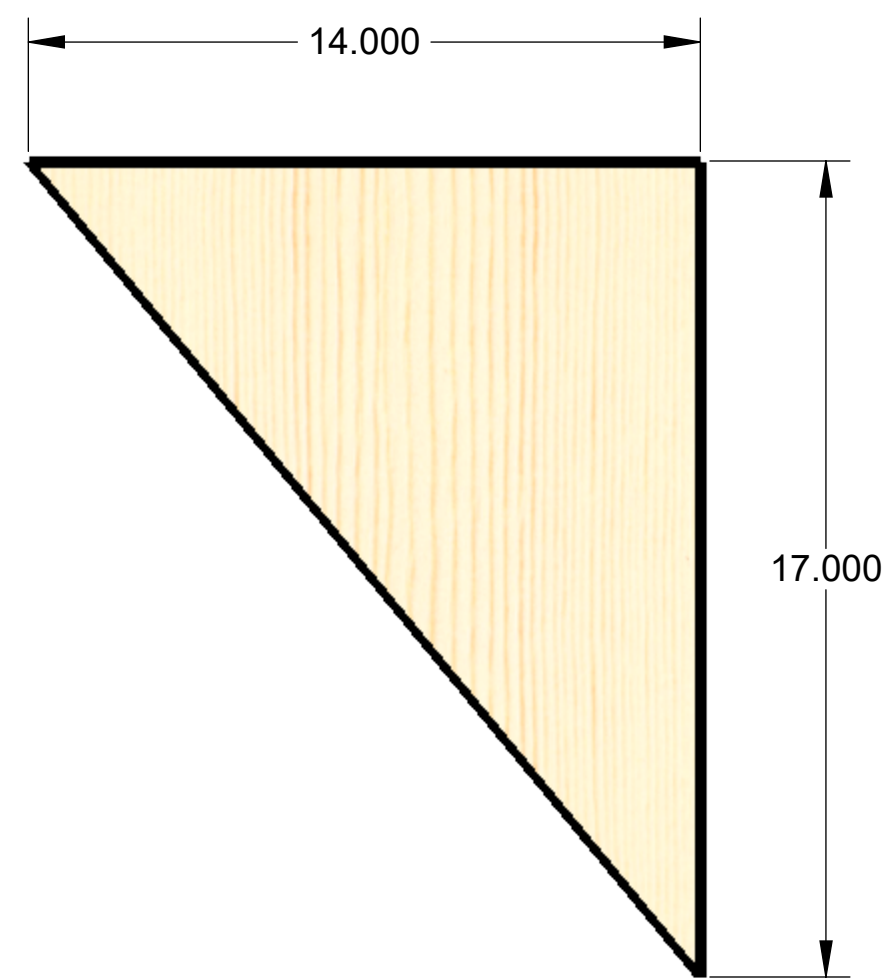

**ANGLE BLOCK**  
ITEM 5  
QTY 2

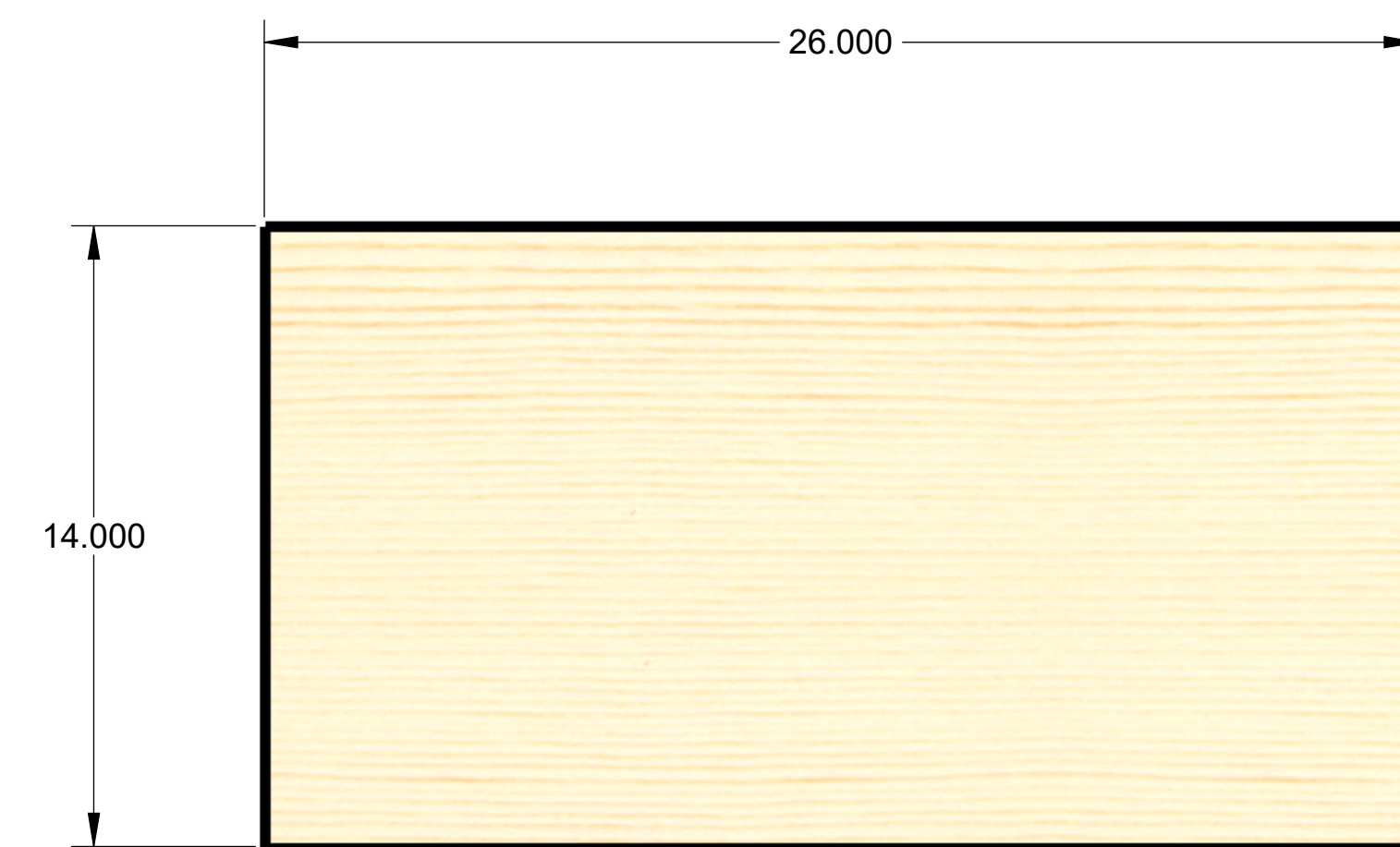

**LID TOP**  
ITEM 6  
QTY 1

8

7

6

5

4

3

1

DWG NO	Enclosure Assembly	SH 3	REV
--------	--------------------	------	-----

D

D

C

C

B

B

A

A



**BASE TOP**  
ITEM 7  
QTY 1

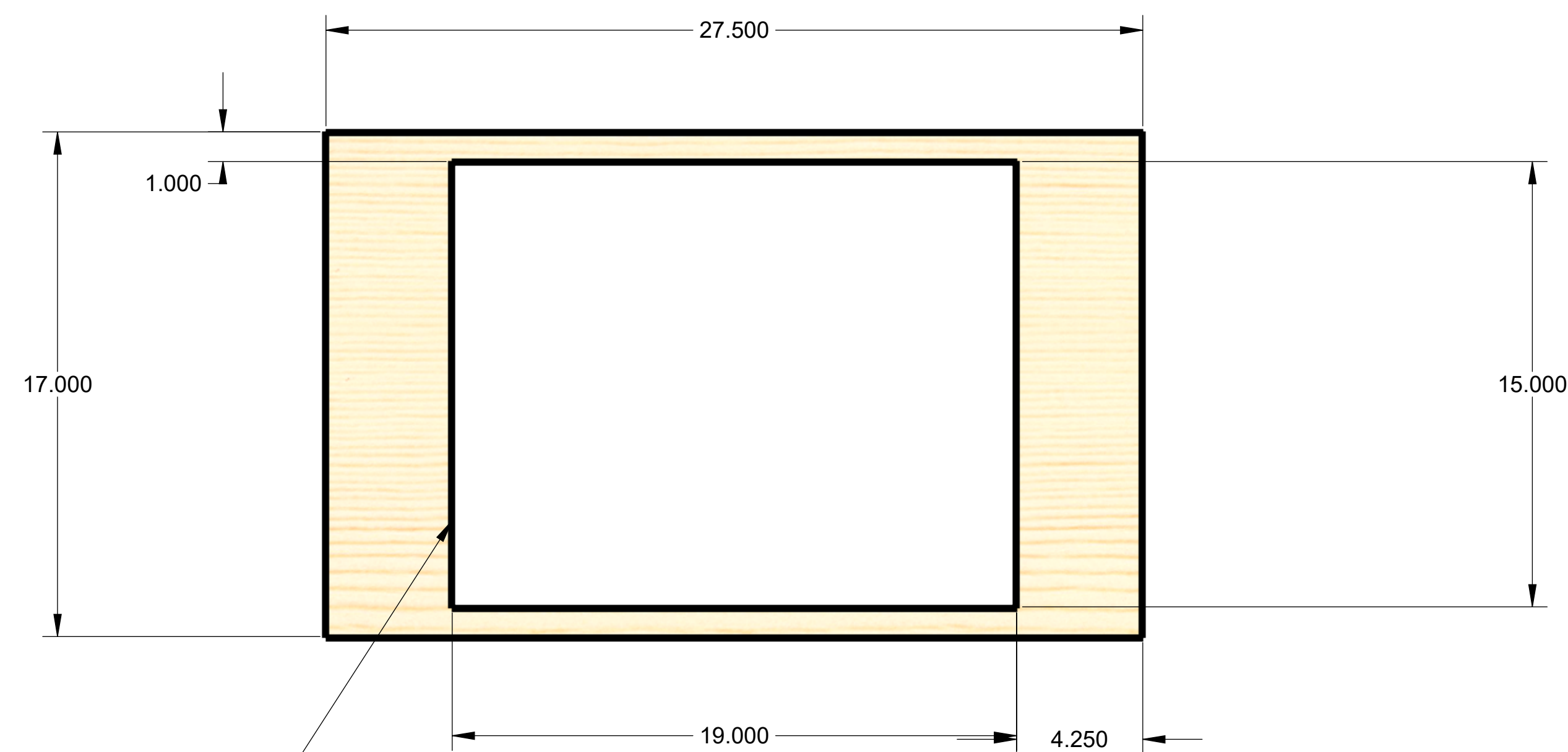

CUT THRU  
OPENING BASED ON 16 X 20 PLEXIGLASS

**WINDOW PLATE**  
ITEM 8  
QTY 1

SIZE DAI	DWG. NO.	REV
<b>D</b>	Enclosure Assembly	
SCALE: 1:4	SHEET 3 of 3	

7

6

5

4

3

2

1