

# DRILLING PROTOCOL FOR ROOTT IMPLANTS

## CAVITY PREPARATION

Every person has a unique bone structure and the clinician has to adapt the drilling protocol to the individual bone quality and anatomical situation. Our drilling protocol is an optimal scheme for different types of bones: D1, D2-D3, D4.

**IMPORTANT!  
WHEN PREPARING THE CAVITY FOR  
THE IMPLANT, ALWAYS ENSURE COOLING.  
USE ONLY SHARP INSTRUMENTS.**

## DRILLING SPEED

Recommended drilling speed:

- initial drilling – 1200–1500 Rpm;
- pilot drilling – 900–1200 Rpm;
- form drilling – 200–800 Rpm.

Implantologist is responsible of drilling speed choice, taking into consideration his experience, preferences and special necessities of the patient.

Important notice: this protocol was prepared with a max speed of 700 rpm, with insertion torque for implants is from 35 to 50 Ncm.

## IMPLANT POSITION

1. The length of the implant thread without the neck. Placing the implant to the bone till the start of the implant neck and till the end-point of the implant thread.

2. The length of the implant thread + implant's neck. Placing the implant to the bone till the end-point of the implant neck leaving only abutment over the bone.

For the 2<sup>nd</sup> option, drilling depth should go 3.0 mm for ROOTT C and 1.5 mm for ROOTT CS deeper than chosen implant thread length.

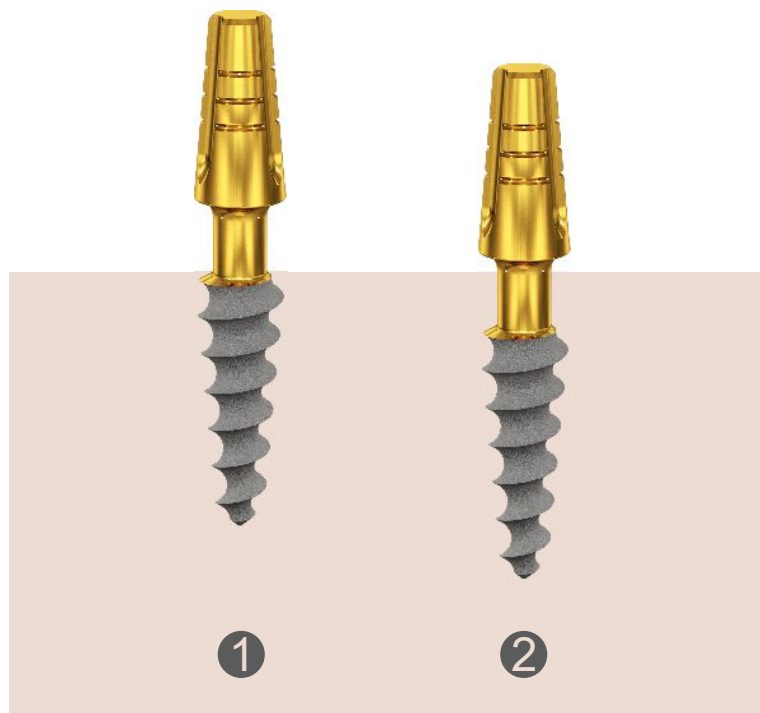

# ROOTT C/CS implants installation using tapered drills

## Drills

Lance drill DB2020 can be used for initial drilling by setting the drilling axis before using pilot drill D2020.

Drill with tapered drills to the appropriate depth, required for specific case. If after using the previous drill the torque is still more than 50 Ncm while inserting the implant, the cavity has to be widened. Just widen the osteotomy with drill D5506.

All drills have laser marking, which indicates drill's depth in bone. Markings are lasered every 2 mm, pilot drill from 4 to 18 mm, tapered drills from 4 to 16 mm.

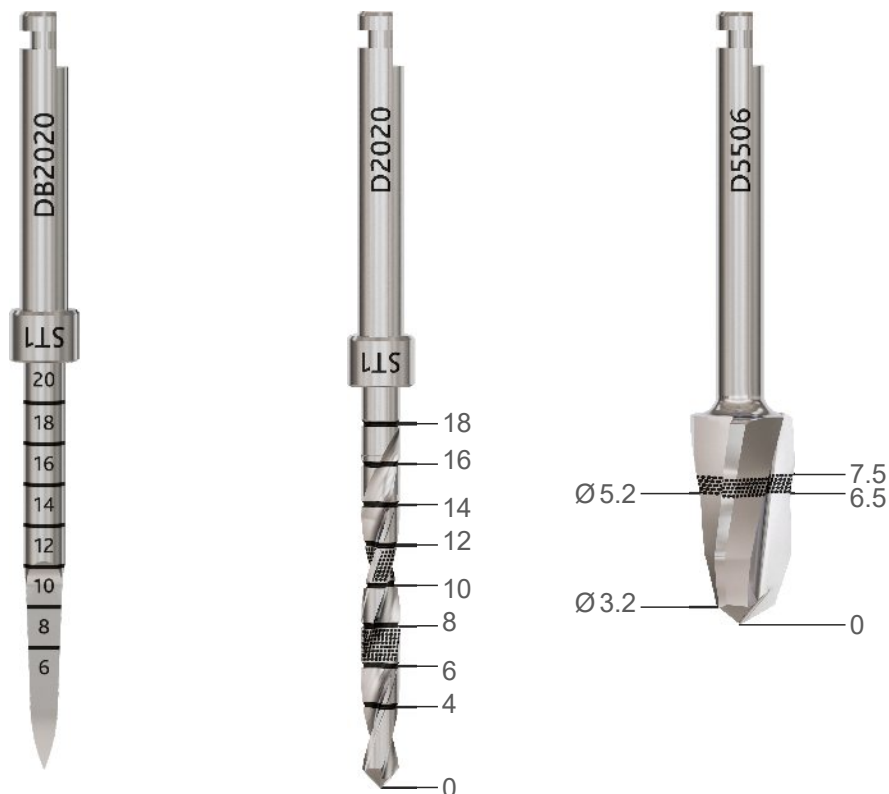

Tapered drills have V-shaped tips, for better correlation with the implant, 3 cutting edges offer good stability. The tapered shape reduces frictional heating. Variable helix for enhanced drilling control and twisted flute for bone extraction. Angled back cutting edge allows compressing of bone when drilling in counter-clock wise (reverse).



**NOTE**

For the best result it is recommended to use a smaller diameter drill and try inserting the implant.

## Implants

ROOTT C/CS implants have a “V” shape and compressive thread. Each ROOTT C/CS implant has different anatomy of the implant. From implant’s maximal diameter and diameter of the second thread depends different drilling protocols for short (6-8 mm) and long (10-20 mm) implants.

ROOTT CS and ROOTT C have the same anatomy except that ROOTT CS has smaller neck in length than ROOTT C.

ROOTT **C**

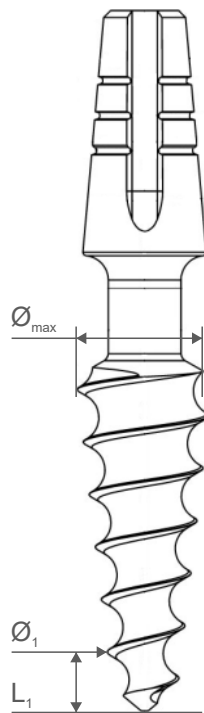



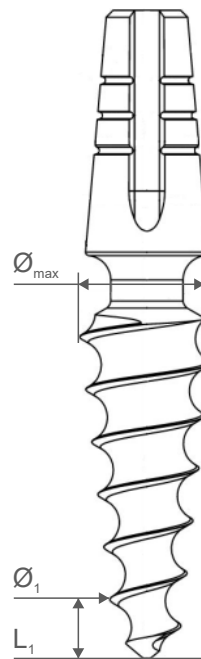







































ROOTT **CS**



$\varnothing_{\max}$  – maximal diameter, mm

$\varnothing_1$  – diameter of the second thread, mm

$L_1$  – length from bottom till the second thread, mm

	Ø 3.0 mm	Ø 3.5 mm	Ø 4.0 mm	Ø 4.5 mm	Ø 5.0 mm	Ø 5.5 mm
L 6 mm	 C3006 3.0 2.0 1.3	 C3506 3.4 2.1 1.35	 C4006 3.9 2.5 1.4	 C4506 4.3 3.1 1.55	 C5006 4.8 3.4 1.65	 C5506 5.2 3.5 1.75
L 8 mm	 C3008 3.0 2.0 1.3	 C3508 3.4 2.0 1.35	 C4008 3.9 2.5 1.4	 C4508 4.3 3.0 1.55	 C5008 4.8 3.4 1.8	 C5508 5.2 3.4 1.65
L 10 mm	 C3010 3.0 1.9 1.3	 C3510 3.4 2.0 1.35	 C4010 3.9 2.0 1.35	 C4510 4.3 2.6 1.5	 C5010 4.8 2.8 1.6	 C5510 5.2 2.7 1.5
L 12 mm	 C3012 3.0 1.8 1.3	 C3512 3.4 1.9 1.35	 C4012 3.9 1.95 1.35	 C4512 4.3 2.5 1.5	 C5012 4.8 2.9 1.6	 C5512 5.2 2.6 1.5
L 14 mm	 C3014 3.0 1.8 1.3	 C3514 3.4 1.8 1.35	 C4014 3.9 1.9 1.35	 C4514 4.3 2.4 1.5	 C5014 4.8 2.5 1.5	 C5514 5.2 2.4 1.45
L 16 mm	 C3016 3.0 1.9 1.3	 C3516 3.4 1.9 1.35	 C4016 3.9 1.9 1.35	 C4516 4.3 2.3 1.5		
L 18 mm	 C3018 3.0 1.8 1.3	 C3518 3.4 1.9 1.35	 C4018 3.9 1.9 1.35	 C4518 4.3 2.3 1.5		
L 20 mm	 C3020 3.0 1.8 1.3	 C3520 3.4 1.8 1.35	 C4020 3.9 1.85 1.35	 C4520 4.3 2.3 1.5		

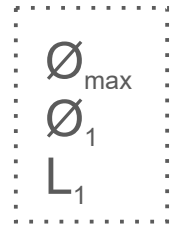

# IMPLANTS C30XX

## D4 BONE

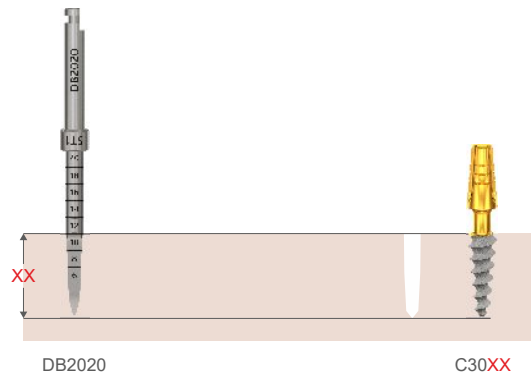

## D2-D3 BONE

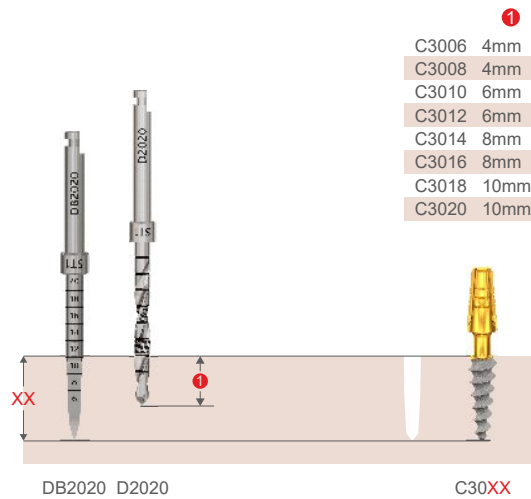

## D1 BONE

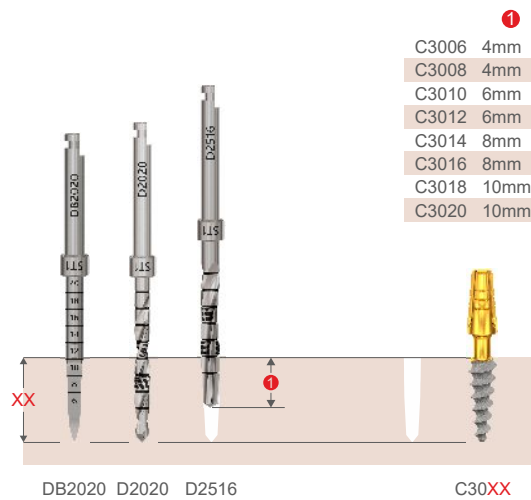

Here xx is the length of the implant, mm

# IMPLANTS C35XX

## D4 BONE

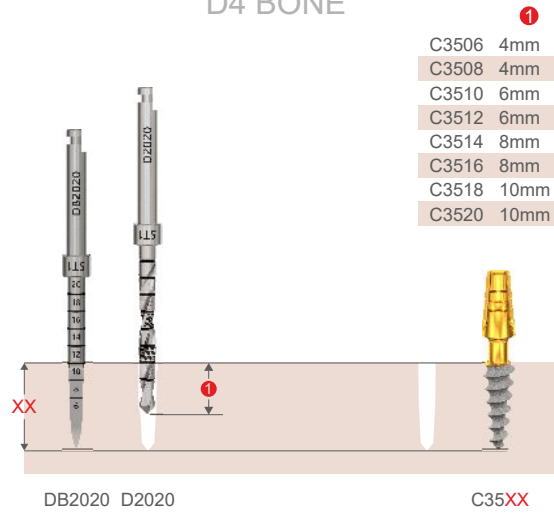

## D2-D3 BONE

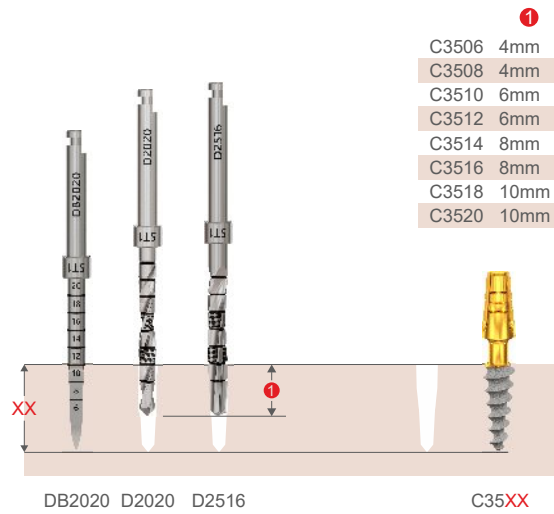

## D1 BONE

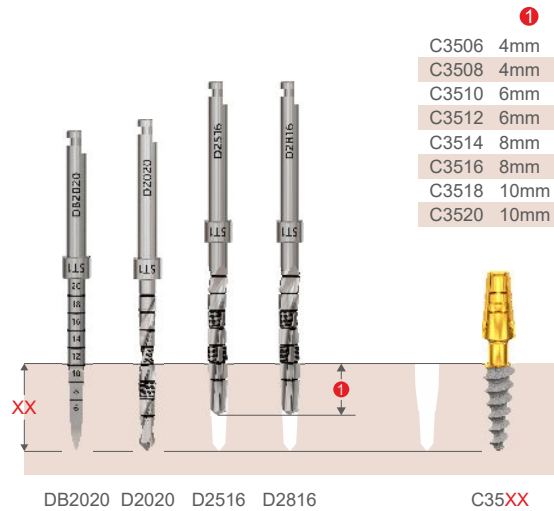

Here xx is the length of the implant, mm



# IMPLANT C40XX

## D4 BONE

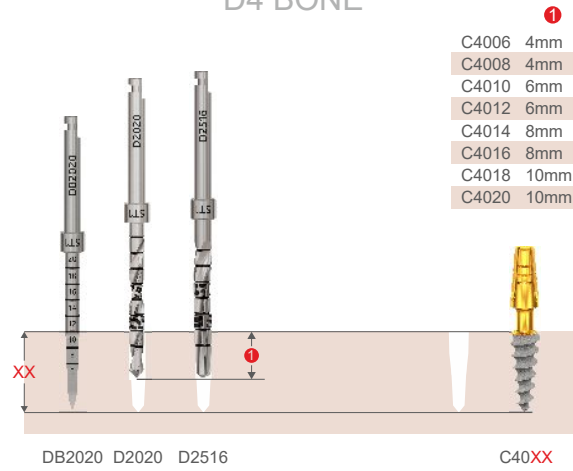

## D2-D3 BONE

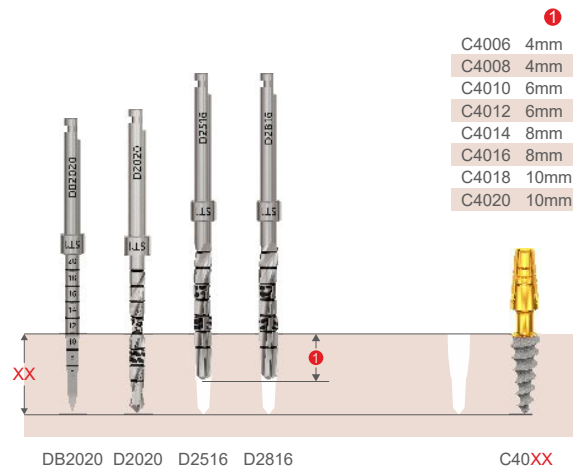

## D1 BONE

### IMPLANT C4006–C4508

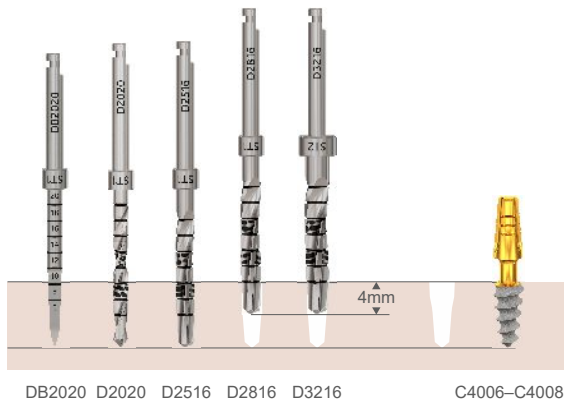

### IMPLANT C4010–C4020

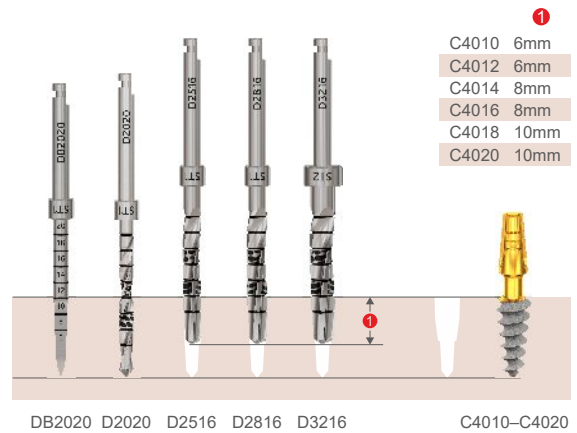

Here xx is the length of the implant, mm

# IMPLANT C45XX

## D4 BONE

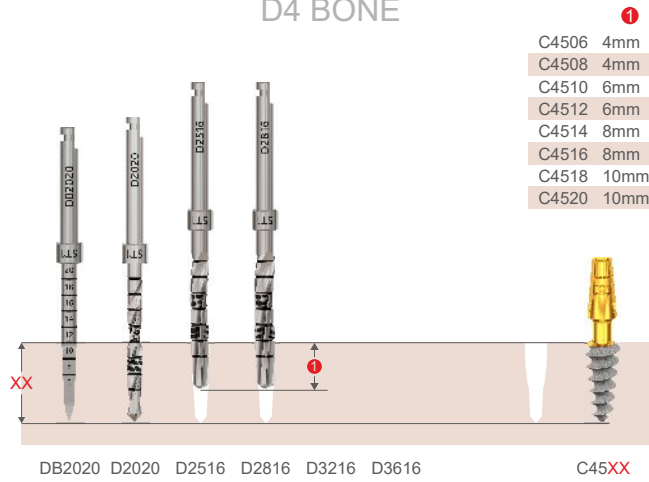

## D2-D3 BONE

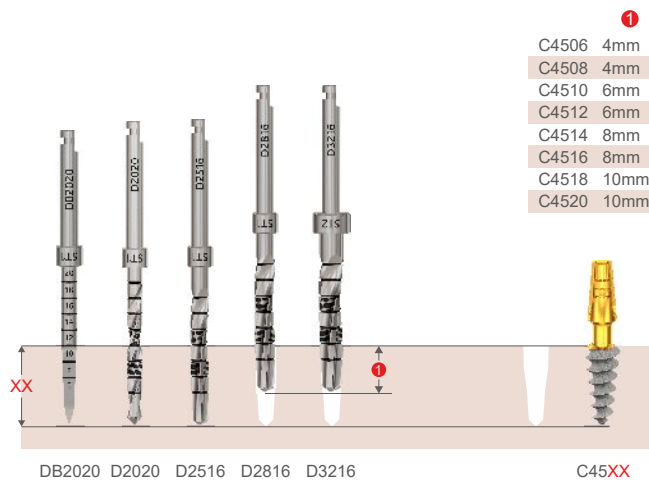

## D1 BONE

### IMPLANT C4506-C4508

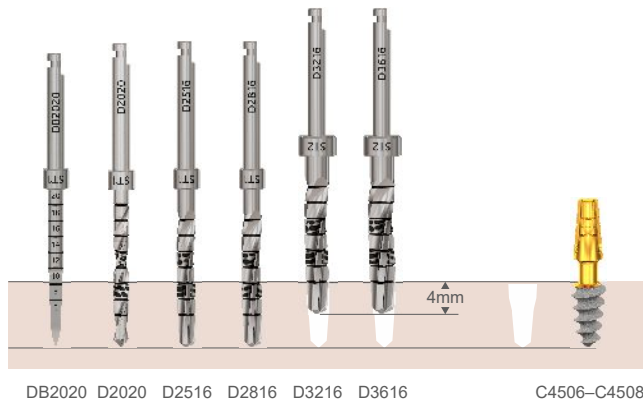

### IMPLANT C4510-C4520

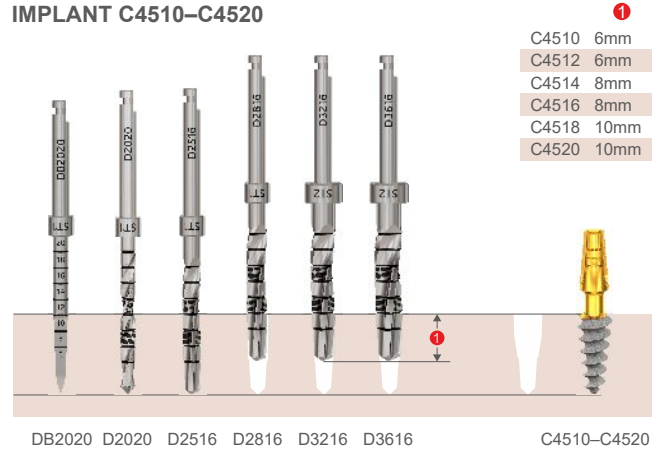

Here xx is the length of the implant, mm

# IMPLANT C5006-C5008

## D4 BONE

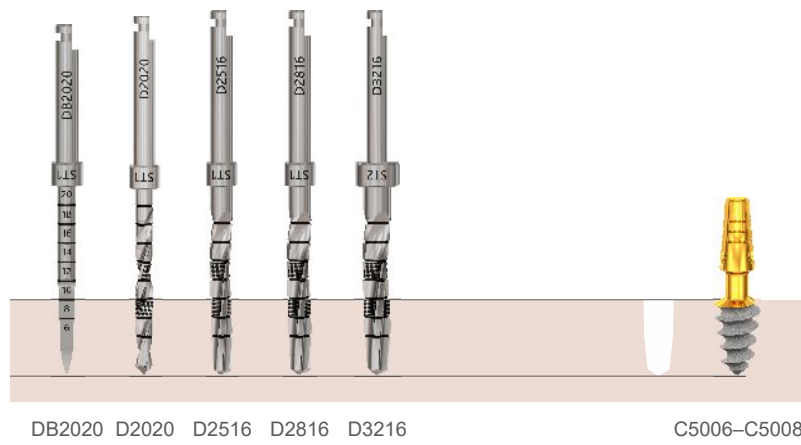

## D2-D3 BONE

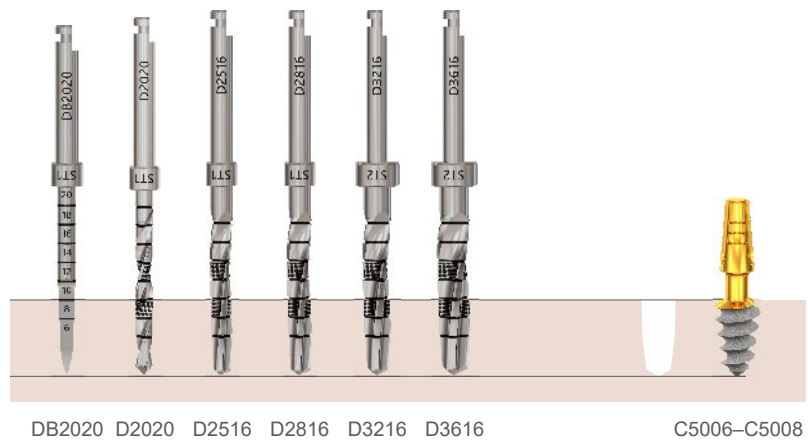

## D1 BONE



# IMPLANT C5010-C5014

## D4 BONE

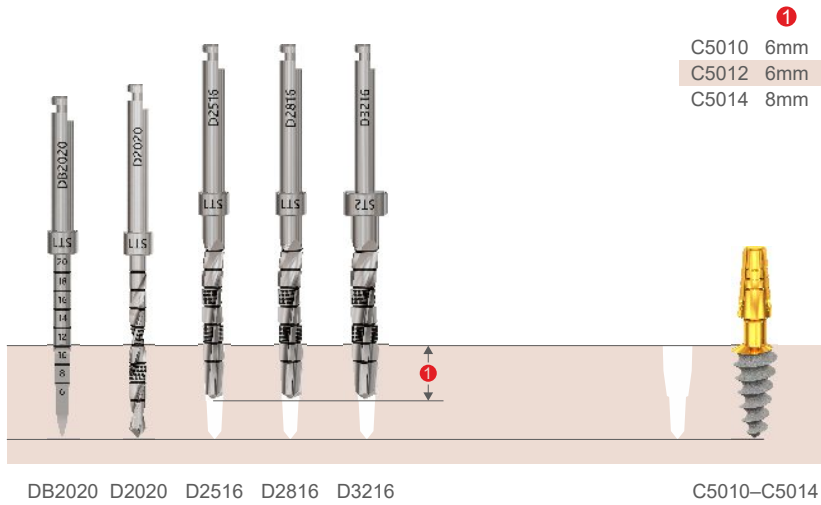

## D2-D3 BONE

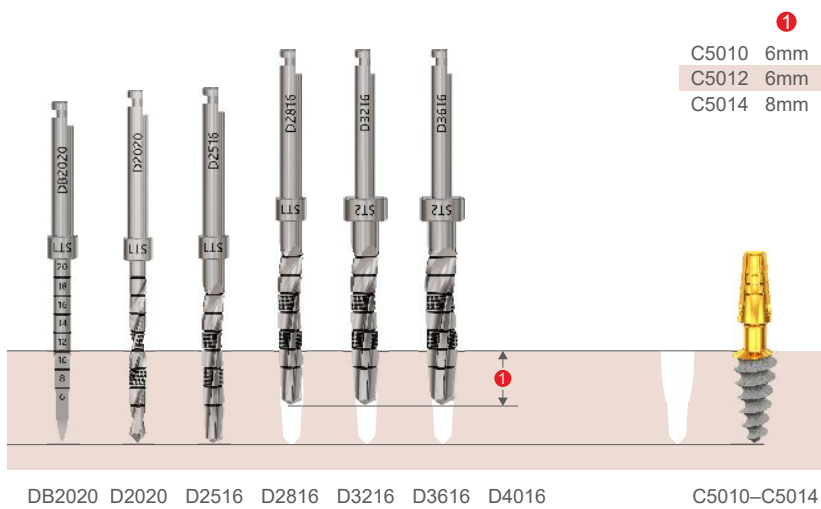

## D1 BONE

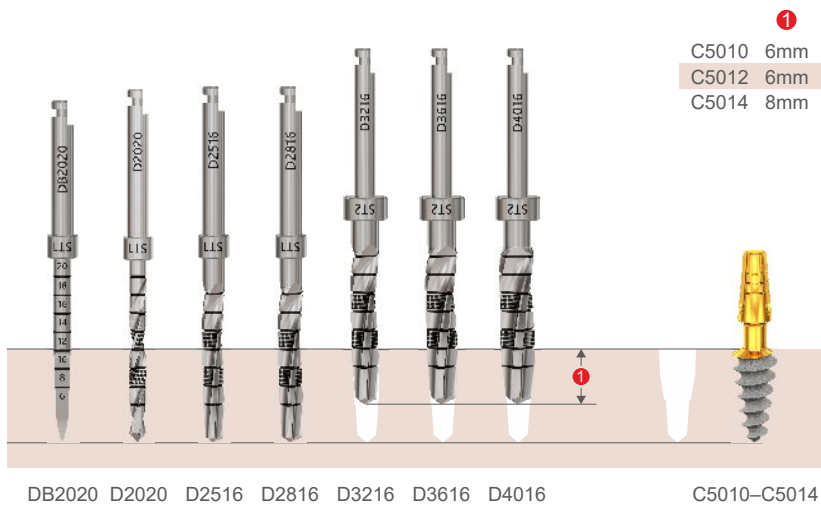

# IMPLANT C5506-C5508

## D4 BONE

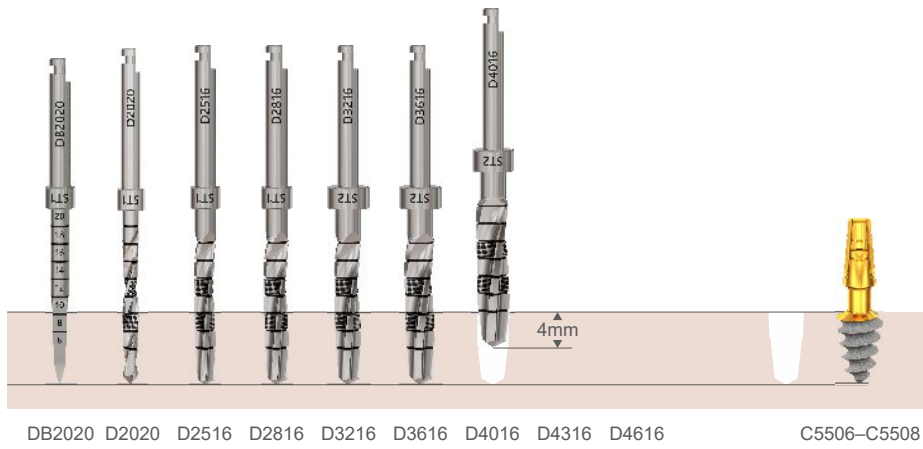

## D2-D3 BONE

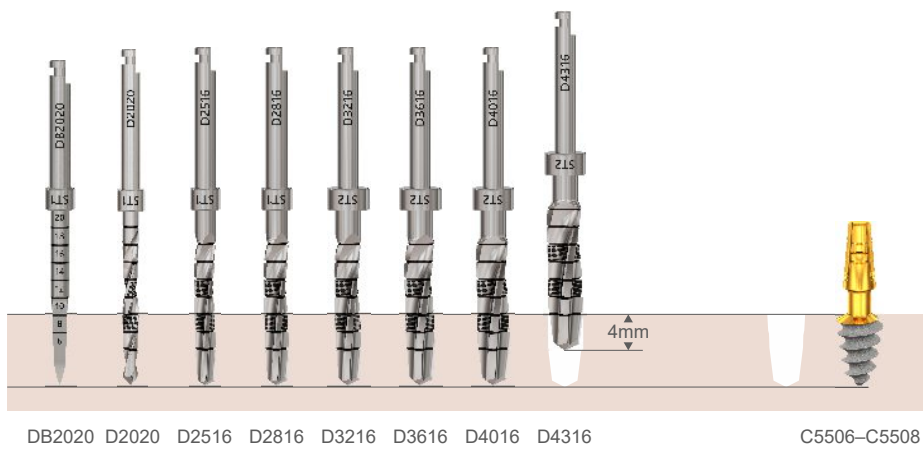

## D1 BONE



# IMPLANT C5510-C5514

## D4 BONE

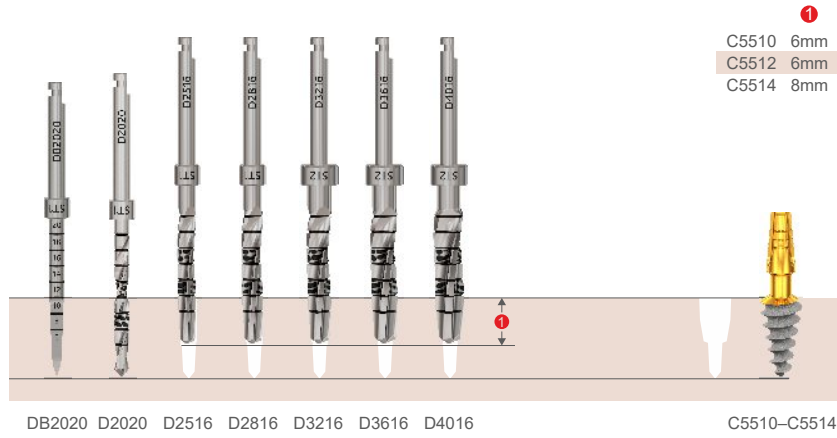

## D2-D3 BONE

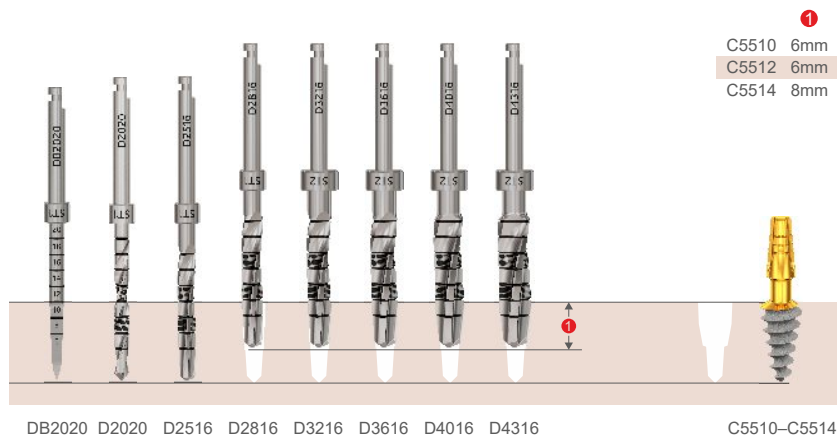

## D1 BONE

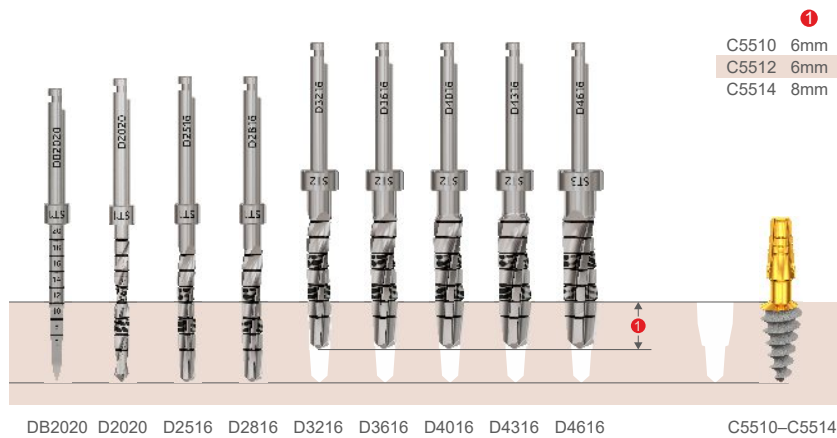

# ROOTT C implants installation using tapered drills

Implant	D4 bone		D2-D3 bone		D1 bone		
Ø 3.0 mm	DB2020		DB2020 D2020*		DB2020 D2020 D2516*		C3006, C3008 - 4 mm * C3010, C3012 - 6 mm C3014, C3016 - 8 mm C3018, C3020 - 10 mm
Ø 3.5 mm	DB2020 D2020		DB2020 D2020 D2516*		DB2020 D2020 D2516* D2816*		C3506, C3508 - 4 mm * C3510, C3512 - 6 mm C3514, C3516 - 8 mm C3518, C3520 - 10 mm
Ø 4.0 mm	6-20 mm DB2020 D2020* D2516*		6-20 mm DB2020 D2020 D2516* D2816*		6-8 mm 10-20 mm DB2020 DB2020 D2020 D2020 D2516 D2516* D2816* D2816* D3216* D3216*		C4006, C4008 - 4 mm * C4010, C4012 - 6 mm C4014, C4016 - 8mm C4018, C4020 - 10 mm
Ø 4.5 mm	6-20 mm DB2020 D2020 D2516* D2816*		6-20 mm DB2020 D2020 D2516 D2816* D3216*		6-8 mm 10-20 mm DB2020 DB2020 D2020 D2020 D2516 D2516 D2816 D2816* D3216* D3216* D3616* D3616*		C4506, C4508 - 4 mm * C4510, C4512 - 6 mm C4514, C4516 - 8 mm C4518, C4520 - 10 mm
Ø 5.0 mm	6-8 mm 10-14 mm DB2020 DB2020 D2020 D2020 D2516 D2516* D2816 D2816* D3216 D3216*		6-8 mm 10-14 mm DB2020 DB2020 D2020 D2020 D2516 D2516 D2816 D2816* D3216 D3216* D3616 D3616*		6-8 mm 10-14 mm DB2020 DB2020 D2020 D2020 D2516 D2516 D2816 D2816 D3216 D3216* D3616 D3616* D4016 D4016*		C5006, C5008 - 4 mm * C5010, C5012 - 6 mm C5014 - 8 mm
Ø 5.5 mm	6-8 mm 10-14 mm DB2020 DB2020 D2020 D2020 D2516 D2516* D2816 D2816* D3216 D3216* D3616 D3616* D4016* D4016*		6-8 mm 10-14 mm DB2020 DB2020 D2020 D2020 D2516 D2516 D2816 D2816* D3216 D3216* D3616 D3616* D4016 D4016* D4316* D4316*		6-8 mm 10-14 mm DB2020 DB2020 D2020 D2020 D2516 D2516 D2816 D2816 D3216 D3216* D3616 D3616* D4016 D4016* D4316 D4316* D4616* D4616*		C5506, C5508 - 4 mm * C5510, C5512 - 6 mm C5514 - 8 mm