

GENERAL NOTES

Precast concrete shall be exposure Class S and meet min compressive strength of 35MPa

Cement: Type GU
 Air Category: 4.0% - 7.0%
 Aggregate: CSA/CAN A23.4 Maximum Size: 20mm
 Admixtures: CSA/CAN A23.4
 Reinforcing: Grade 400W CSA G30.18-09
 Inserts/Embeds: As noted in drawing details

Manufacture of precast concrete units shall be in accordance with specification CSA A23.4

**** LEKO PRECAST LTD SHALL NOT BE RESPONSIBLE FOR ANY INSTALLATION PRACTICES FOLLOWED ON-SITE UNLESS PERFORMED BY LEKO PRECAST LTD ****

8,700kg (19,250 LBS)

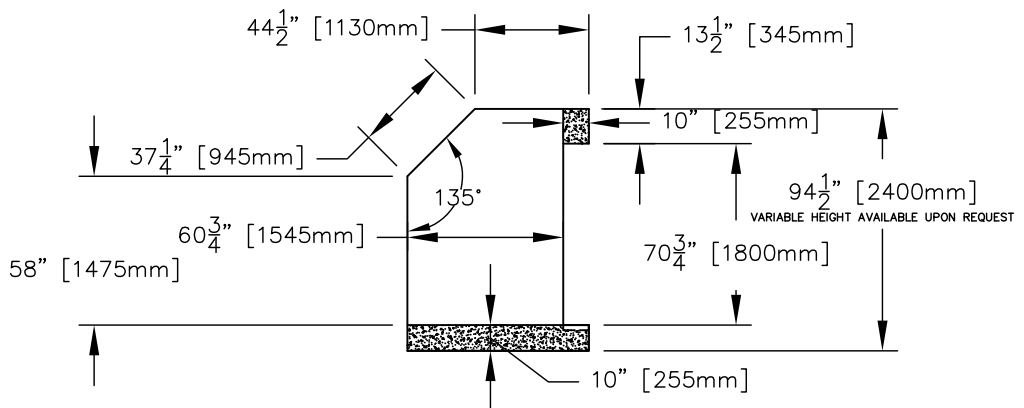

HEADWALL C/W OPENING UP TO 1900mm

DRAWN BY: JA	CHECKED BY:	APPROVED BY:	DATE: February 2019
ASSEMBLY DWG.	PREVIOUS DWG.	DRAWING NO. I1225	REVISION 1
SCALE: 1:75 ISOMETRIC: N/A			
DO NOT SCALE THIS DRAWING			