

# CTC

INDUSTRIAL  
MONITORING

VIBRATION  
SOLUTIONS



VIBRATION ANALYSIS HARDWARE



PROTECTION & RELIABILITY INSTRUMENTS

SHORT FORM CATALOG

## Who We Are

At CTC, we are a family-owned and operated business passionate about providing the best quality products backed by excellent customer service. We are the industry leader in quick delivery for stock and built-to-order products. All CTC products are proudly made or assembled in the U.S.A. We always honor our best-in-class warranties, and our customer service seeks to provide the best customer experience in the world.

## What We Do

CTC is the world leader in the design and manufacture of industrial accelerometers, piezo velocity transducers, 4-20 mA vibration sensors, and proximity probes as well as all related mounting hardware, cabling, and junction boxes. Our products enable efficient vibration monitoring for predictive maintenance in a wide variety of industries. Industries served include cement, mining, petrochemical, food & beverage, auto, steel, wind, paper, power generation, water & wastewater treatment, pharmaceutical, hospitals, bottling, and more. Our mission is to offer the most extensive collection of accelerometers and vibration hardware products, as well as the tools for installation. Our products are compatible with multiple third-party data collectors and online monitoring systems.



A handwritten signature in black ink that reads "Todd Cook".

**TODD  
COOK**

Co-Owner

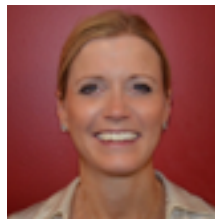

A handwritten signature in black ink that reads "Laura B. Cook".

**LAURA  
COOK**

Co-Owner



A handwritten signature in black ink that reads "Andrew Cook".

**ANDREW  
COOK**

Director of Sales

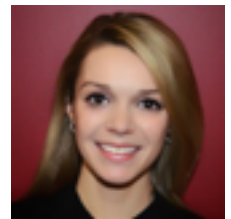

A handwritten signature in black ink that reads "Charlotte Cook".

**CHARLOTTE  
COOK**

Director of Marketing



# CONTENTS

<b>CTC</b> .....	<b>4</b>
Multipurpose Accelerometers.....	4
Ultrasound Sensor .....	5
High-Temperature Accelerometers .....	5
Wind Turbine Accelerometers .....	6
Hazardous Rated Accelerometers.....	7
Temperature & Vibration Sensors .....	7
Triaxial Accelerometers.....	8
Cables.....	9
Connectors.....	10
Adapters & Accessories .....	12
Junction Boxes.....	14
Mounting Hardware .....	16
<b>PRO</b> .....	<b>19</b>
4-20 mA .....	19
Signal Conditioners .....	20
Proximity Probes.....	21
Wireless Vibration Transmitter .....	22
Molded Accelerometers .....	22

## Product Offerings

At CTC, we have two comprehensive product lines to meet your industrial vibration monitoring needs. Our products reflect the input from customers and distributors around the world and are designed and tested to meet the real-world demands of plant environments. We believe our products are the highest quality on the market, which is why we back each product line with our best-in-class warranties.



The CTC product line features vibration analysis hardware for heavy industry.

All CTC products are backed by our unconditional lifetime warranty. If any CTC product should ever fail, we will repair or replace it at no charge.



The PRO line offers 4-20 mA vibration monitoring solutions and proximity probes.

All PRO products are backed by a lifetime warranty on materials and workmanship. PRO will repair or replace any of our products as long as the product was not subjected to misuse, neglect, natural disasters, improper installation, or modification.

## Refund Policy

All stock products qualify for a full refund if returned in new condition within 90 days of shipment. Built-to-order products qualify for a 50% refund if returned in original condition within 90 days of delivery. Custom products are quoted and built specifically to the requirements of the customer, which may include completely custom product designs or private-labeled versions of standard products for OEM customers. Custom products ordered are non-cancellable, non-returnable, and non-refundable.

CTC offers a complete line of industrial accelerometers that withstand temperatures in the range of -58 to 325 °F (-50 to 162 °C). Our ruggedized industrial accelerometers are available in both top or side exit configurations for single axis, biaxial, and triaxial designs. Side exit configurations allow for installations in areas where height is an issue. CTC's variety of industrial accelerometers supports a diverse set of applications with sensitivity values ranging from 10 mV/g to 1000 mV/g. Dual output configurations allow for vibration and temperature outputs.

### Multi-Purpose Accelerometer, Top Exit



**STANDARD SIZE**



**COMPACT SIZE**



**SMALL SIZE**

---

### Multi-Purpose Accelerometer, Side Exit



**STANDARD SIZE**



**COMPACT SIZE**



**SMALL SIZE**



Backed by our Unconditional Lifetime Warranty!

[www.ctconline.com](http://www.ctconline.com)

585-924-5900

## ACCELEROMETERS

### Multi-Purpose Accelerometer, Integral Cable Options



**STANDARD  
INTEGRAL**



**ARMORED  
INTEGRAL**

## ULTRASOUND

### Ultrasound Sensor



Sensitivity: 100 mV/g  
Resonant Peak: 44 kHz

#### UEB330

High frequency ultrasound sensor with high amplitude resonance peak for stress wave measurement techniques and IEPE amplifier technology.

## HIGH-TEMPERATURE

### High-Temperature Accelerometers



**AC207**  
100 mV/g  
Max Temp: 325° F (162° C)



**AC208**  
100 mV/g  
Max Temp: 325° F (162° C)



**CM362-7A**  
50, 100 mV/g  
100 mV/in/sec  
Max Temp: 650° F (343° C)



Backed by our Unconditional Lifetime Warranty!

[www.ctconline.com](http://www.ctconline.com)

585-924-5900

Power generation is a critical need in today's world. Uptime is the primary concern, and to maintain power generation, the machines need to be running. CTC's goal is to improve reliability with permanently mounted accelerometers to monitor wind turbine vibration and provide early detection for potential failure. CTC has multiple options to fit your specific application. Low-frequency accelerometers are ideal for main bearing and other slow-speed applications. Our multipurpose accelerometers are best suited for gearboxes and generators. All products shown below are rated for 5 kVAC protection.

## Accelerometers for Wind Turbine Applications



**WT202**

General purpose wind turbine accelerometer  
100 mV/g



**WT203**

Low & high frequency wind turbine accelerometer  
100 mV/g



**WT235**

Low & high frequency wind turbine accelerometer  
500 mV/g

---

## Molded Accelerometer



**MEB212**

Lightweight molded accelerometer  
5 kVAC protection  
100 mV/g  
10 ft integral cable



Backed by our Unconditional Lifetime Warranty!

[www.ctconline.com](http://www.ctconline.com)

585-924-5900

# HAZARDOUS RATED

## Hazardous Rated Accelerometers

CTC offers a variety of single axis, biaxial, triaxial, and low capacitance sensors certified for Class I Division 2 (ATEX Zone 2), as well as intrinsically safe protection methods under Class I Division 0, Class 1 Division 1, and IECEx.

Hazard Ratings



**CLASS I DIVISION 1  
ATEX ZONE 0, 1  
IECEx**



**CLASS I DIVISION 2  
ATEX ZONE 2**



# TEMPERATURE & VIBRATION

## Dual Output Temperature and Vibration Sensors

Includes embedded RTD.



**TA102**  
100 mV/g  
10 mV/°C  
Temp Range:  
-40 °F to 250 °F



**TA104**  
100 mV/g  
10 mV/°C  
Temp Range:  
-40 °F to 250 °F



**TR102-M12A**  
100 mV/g  
PT100 RTD  
Temp Range:  
-40 °F to 250 °F



**TR104-M12A**  
100 mV/g/axis  
PT100 RTD  
Temp Range:  
-40 °F to 250 °F



Backed by our Unconditional Lifetime Warranty!

[www.ctconline.com](http://www.ctconline.com)

585-924-5900



## TREA330 Triaxial Accelerometers



**SIDE EXIT**

100 mV/g



**INTEGRAL**

100 mV/g

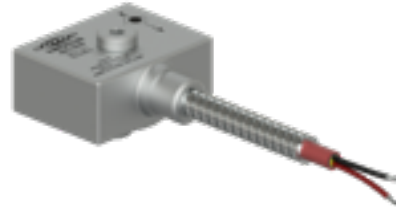

**ARMORED  
INTEGRAL**

100 mV/g

## Other Popular Triaxial Accelerometers



**AC115-M12D**

Low cost 4 pin  
100 mV/g



**AC119**

Biaxial with X & Z axis  
100 mV/g



**AC155**

Low cost 4 pin  
100 mV/g



**AC230**

Premium 4 pin  
100 mV/g



**AC360**

Modal/ODS  
100 mV/g



**AC365**

Modal/ODS  
100 mV/g



**TRCA330**

Compact 4 pin  
10 mV/g



Backed by our Unconditional Lifetime Warranty!

[www.ctconline.com](http://www.ctconline.com)

585-924-5900

## CTC Offers a Variety of Cable Options for All Application and Environmental Criteria

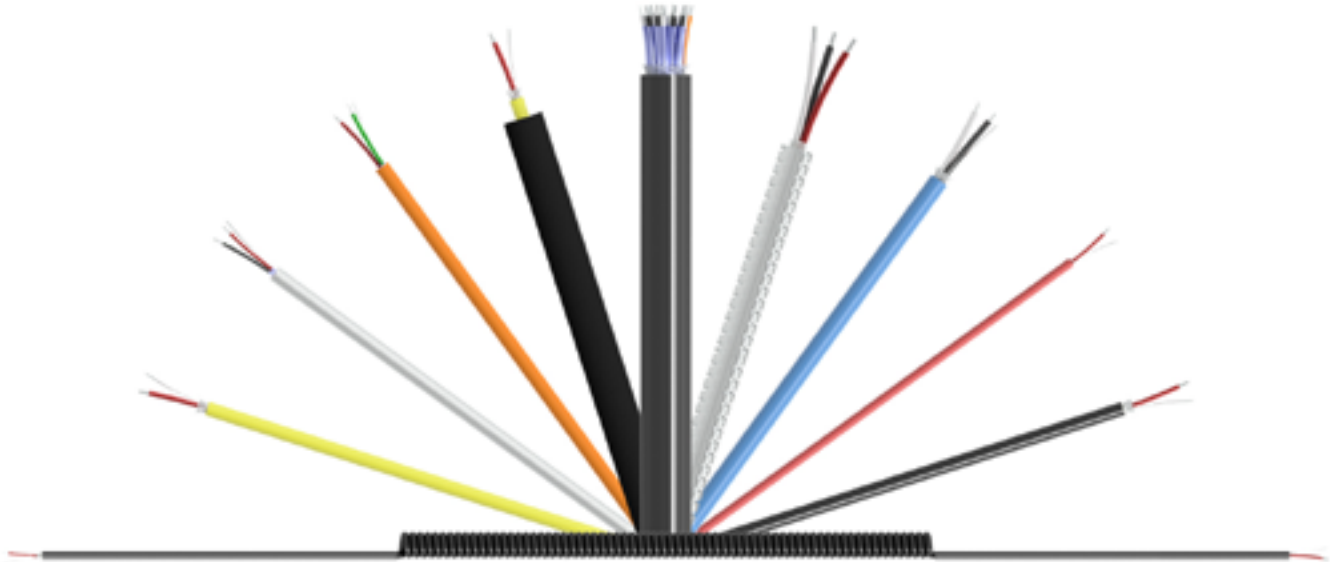

### JACKET TYPES

- Fluorinated ethylene propylene (FEP)
- Polyurethane
- Lightweight Polyurethane
- PVC
- Thermoplastic Elastomer (TPE)
- Low Smoke Zero Halogen

### ARMOR OPTIONS

- Stainless Steel Braided Sheathing
- Stainless Steel Armor
- Hydraulic Hose Armor

### CONDUCTOR OPTIONS

- 2 Conductor
- 3 Conductor
- 4 Conductor
- 6 Conductor
- 8 Pair Multi Conductor
- 12 Pair Multi Conductor
- 16 Pair Multi Conductor
- 12 Triad Multi Conductor

### HAZARDOUS ZONE OPTIONS

Class 1 Division 2 approved cables



Backed by our Unconditional Lifetime Warranty!

[www.ctconline.com](http://www.ctconline.com)

585-924-5900

## CTC Offers a Variety of Standard and Specialty Connectors for Every Possible Application

CTC sensor connectors support temperatures ranging from -58 ° F to 325 ° F. A wide selection of connectors supporting IP (Ingress Protection) ranging from IP66 to IP68 is available.

### A SERIES: 2 OR 3 SOCKET MIL STYLE (C-5015) COMPATIBLE CONNECTOR



Connector options

- Standard
- Right angle
- Hydraulic hose

Material options

- Polycarbonate
- Polyurethane
- Nylon
- Polyphenylene sulfide (PPS)

### D SERIES: 2 OR 3 SOCKET MIL STYLE (C-5015) COMPATIBLE CONNECTOR



Connector options

- Standard
- Grounded to sensor case
- Right angle
- Backshell
- Backshell for Class 1, Division 2
- Molded strain relief
- Bending strain relief

Material options

- Polyurethane

### J SERIES: 2 OR 4 SOCKET MINI-MIL CONNECTOR



Connector options

- Standard
- Strain relief
- Class 1, Division 2 rated

Material options

- Polycarbonate
- Nylon
- Polyurethane

### M SERIES: 5 SOCKET M12 MOLDED CONNECTOR



Connector options

- Available in 2, 3, 4, and 5 live pin configurations

Material options

- Nylon
- Polycarbonate
- Polyurethane

### V SERIES: VITON BOOT



Connector options

- Available in 2 or 3 live pin configurations

Material options

- Viton seal with
  - Nylon insert option
  - PPS insert option

Many other connector options are available. Please visit our website for more details.



Backed by our Unconditional Lifetime Warranty!

[www.ctconline.com](http://www.ctconline.com)

585-924-5900

## Data Collector Cord Sets

CTC offers a variety of OEM replacement data collector cables and portable cable options for all major vibration analyzer manufacturers. Data collector cables are available in both coiled and straight cable options. Replacement cable assembly and adapters are available for every major data collector including: ACOEM, ADASH Ltd, GE/Commtest, Azima/DLI, Emerson/CSI, Erbesd, GE/Bently Nevada, Pruftechnik, Rockwell/Entek, Schenck Trebel, SDT, SEMAPI, SKF, and SPM.

## Popular Data Collector Connectors



**EMERSON/CSI  
C555**

Channel A acceleration input to CSI 2130 & 2140



**SKF  
C66**

Channel A input for CMXA50, 70, 75 & 80



**ACOEM  
C494**

Single channel input for Falcon data collectors



**PRUFTECHNIK  
C618**

Single channel input to VIBXpert II



**ROCKWELL/ENTEK  
C22**

Single channel input for dataPAC & enPAC



**GE/COMMTEST  
C416**

Triaxial input X, Y and Z for vb6 & vb8

Popular Adapters



**CB901-1A**  
2 pin MIL to 2 pin MIL  
in-line feed thru



**CB903-1A**  
2 pin MIL to 2 pin MIL  
bulk head feed thru,  
0.5 in. NPT



**CB908-1A**  
2 pin MIL to BNC plug  
adapter with molded  
reinforcement

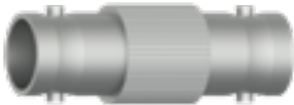

**CB910-1A**  
In-line BNC jack  
adapter

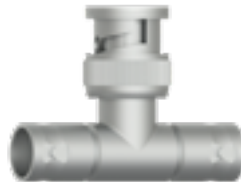

**CB911-1A**  
BNC tee adapter



**CB911-3A**  
In-line BNC plug  
adapter



**CB912-1A**  
2 socket MIL to BNC  
plug adapter



**CB917-1A**  
BNC feed-thru  
connector with  
mounting bracket



**EMPP**  
BNC jack  
measurement point  
with protective cover



Backed by our Unconditional Lifetime Warranty!

[www.ctconline.com](http://www.ctconline.com)

585-924-5900

Specialty Mounting Adapters & Studs

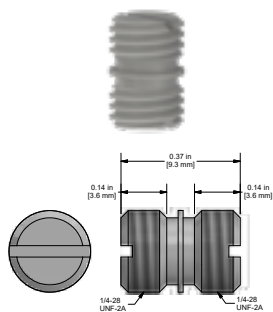

**MH108-1B**  
1/4-28 to 1/4-28  
mounting stud  
stainless steel

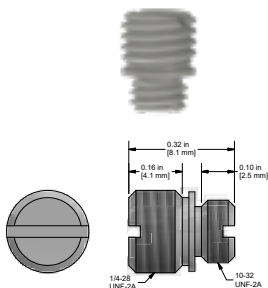

**MH108-3B**  
1/4-28 to 10-32  
adapter stud  
stainless steel

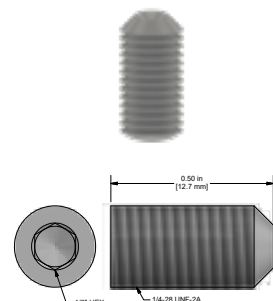

**MH108-4B**  
1/4-28 set screw  
1/2 in. length  
stainless steel

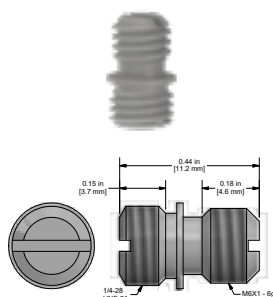

**MH108-5B**  
1/4-28 to M6x1  
adapter stud  
stainless steel

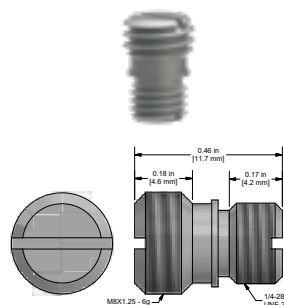

**MH108-6B**  
1/4-28 to M8  
adapter stud  
stainless steel

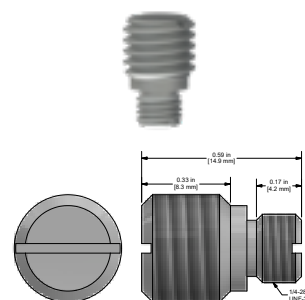

**MH108-7B**  
1/4-28 to M10  
adapter stud  
stainless steel

Junction Box Accessories



**JB903-1A**  
Cord grip for use with  
cable diameter  
0.118 in. - 0.256 in.



**JB938-1A**  
1 in. rigid body  
conduit fitting



**JB938-2A**  
1/4 in. rigid body  
conduit fitting



At CTC, we offer the widest variety of junction boxes in the world. Our junction box solutions allow for the monitoring of remotely mounted vibration sensors, which would be otherwise restricted to human access due to safety considerations. Also offered is a selection of low-cost cable termination boxes that allow multiple measurement points to be routed to a cost-effective location to gather data. Many CTC junction boxes offer continuous output options for direct interface to online monitoring systems.

## iBox Series

Fully featured vibration junction box with IEPE sensor condition indicator lights and convenient interface with fold-forward panel for easy wiring. NEMA 4X (IP66) rating.



### JB100/JB200

Available with single axis, biaxial, and triaxial outputs



### JB100 - 24-48 Channel

Available in 24, 36, or 48 channels



### JB300 SLOPE TOP

Available in 4, 6, 8, 10, or 12 channels

## Switch Boxes



### SB102/SB202

Fiberglass or stainless steel switch boxes available in 4, 6, 8, 10, or 12 channels



### SB142/SB242

Fiberglass or stainless steel switch boxes for dual output available in 4, 6, or 8 channels

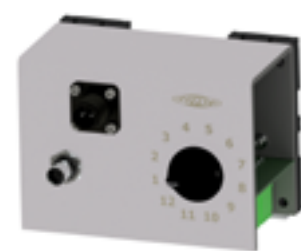

### SSB-MODX

12 channel DIN rail mountable switch module subassembly



Backed by our Unconditional Lifetime Warranty!

[www.ctconline.com](http://www.ctconline.com)

585-924-5900

## Cable Termination and MAXX Boxes



### CT101

Cable termination boxes for 1, 2, 3, and 4 channels



### MMX-MOD3

DIN rail mountable module

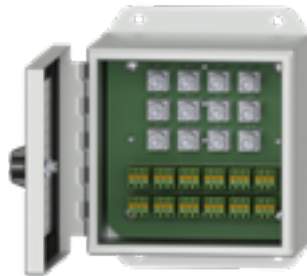

### MX102/MX202

Fiberglass or stainless steel MAXX boxes available in 1-12 channels



### MX502

Aluminum Mini-MAXX boxes available in 1, 2, 3, and 4 channels

---

## Cable Reduction Boxes



### CR102/CR202

Fiberglass or stainless steel cable reduction boxes for 8, 12, and 16 channels

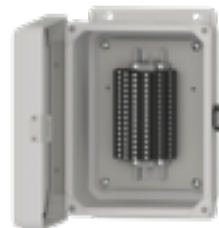

### CRHT102/CRHT202

Fiberglass or stainless steel high temperature (-40 °F to 212 °F/-40 °C to 100 °C) cable reduction boxes for 12 and 16 channels



CTC offers a variety of adhesive and stud mounted sensor mounting pads. These are available with magnet pad options for portable field applications, which include both the flat and two rail mounting options. CTC offers vibration pads to ensure very repeatable targets for route-based vibration measurement needs. Specialty mounting accessories for fin-cooled motors are available, as well as a variety of extension adapters are also available to allow access to bearing locations not typically permitted due to restricted access. Visit our website for a complete list of our mounting hardware solutions.

## Rare Earth Magnetic Bases

made from Neodymium Iron Boron

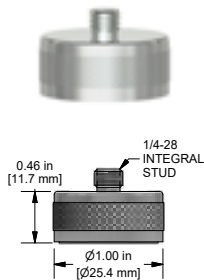

**MH103-1B**

Flat surface  
pull strength:  
40lbs/18kg



**MH104-1B**

Flat surface  
pull strength:  
60lbs/27kg

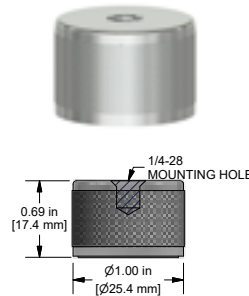

**MH122-1A**

Flat surface  
pull strength:  
40lbs/18kg

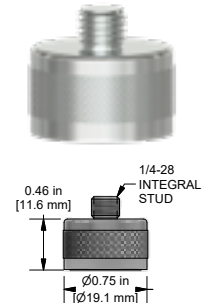

**MH136-1A**

Flat surface  
pull strength:  
25lbs/11kg

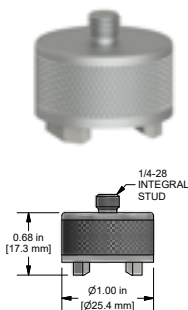

**MH112-1A**

Multipurpose  
pull strength:  
30lbs/14kg

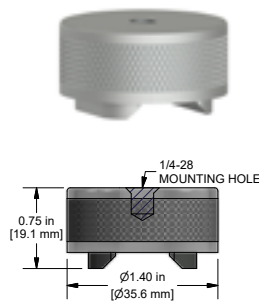

**MH114-3A**

Multipurpose  
pull strength:  
50lbs/23kg

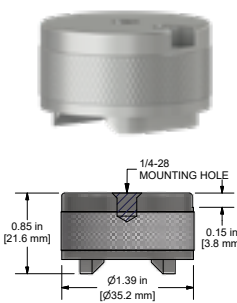

**MH114-3T**

Multipurpose  
pull strength:  
50lbs/23kg

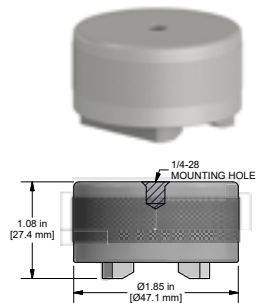

**MH115-2A**

Multipurpose  
pull strength:  
95lbs/43kg



Backed by our Unconditional Lifetime Warranty!

www.ctconline.com

585-924-5900

**Accelerometer Quick Disconnects**

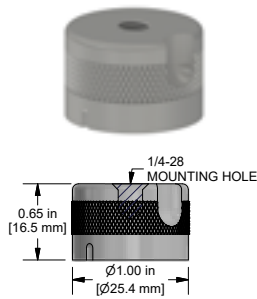

**MH107-1A**

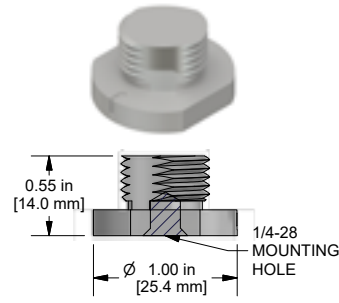

**MH107-1B**

**Mounting Pads/Magnet Targets**

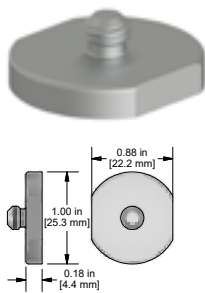

**MH101-1B**

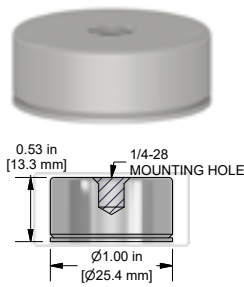

**MH130-1A**

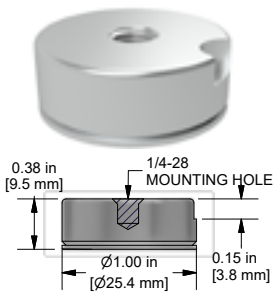

**MH130-1T**



**MH133-1A**

**Zerk and Specialty Mounting Adapters**

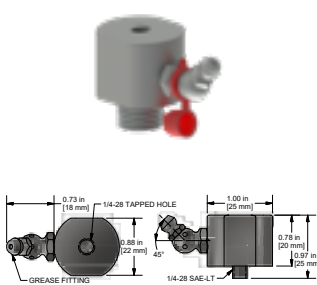

**MH134**

Zerk Adapter

See website for additional details

Available mounting threads:  
1/4 NPT, 1/8 NPT

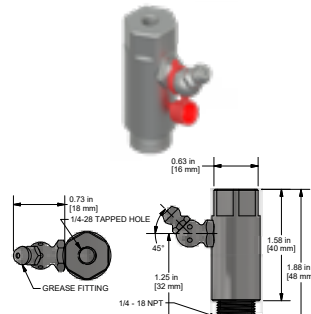

**MH134-4B**

Zerk Adapter

See website for additional details

Available mounting threads:  
1/4 NPT

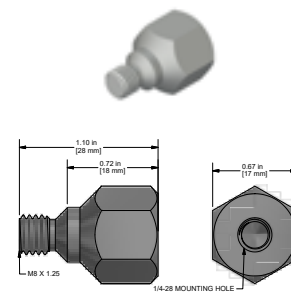

**MH143-1A**

Hex head mounting stud  
for Accelerometers

SPM Compatible



**Backed by our Unconditional Lifetime Warranty!**

[www.ctconline.com](http://www.ctconline.com)

585-924-5900

**Motor Fin Probe Pads**

Take measurements from hard-to-reach places.

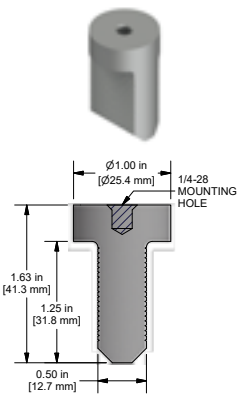

**MH118-1A**

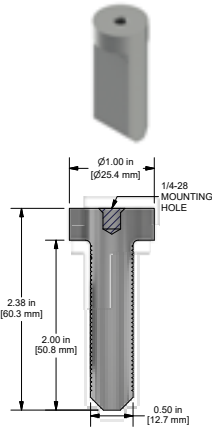

**MH118-2A**

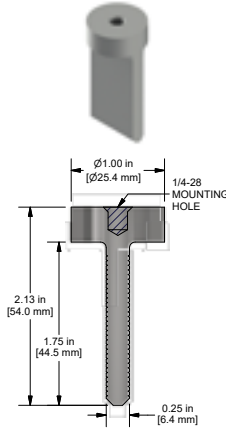

**MH118-3A**

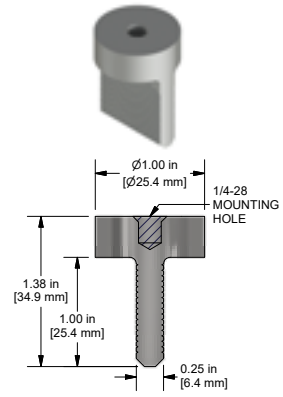

**MH118-4A**

Our fin mount probes are perfect for narrow measurement points in motors, turbines, and other machinery. Fin mounts can be used with portable route measurements or permanently mounted accelerometers.

**Accelerometer Installation Tool Kit**



**MH117 SERIES**

Spot face and pilot hole drill in one operation.  
Option for taps and ratcheting tap handle included.

**High speed steel end mill tool kits**

Available thread sizes	Available end mill diameters
1/4-28	5/8 in.
10-32	1 in.
M6x1	1 1/4 in.
M8x1.25	

**Carbide tipped end mill tool kits**

Available thread sizes	Available end mill diameters
1/4-28	5/8 in.
M8x1.25	1 in.
	1 1/4 in.



Backed by our Unconditional Lifetime Warranty!

www.ctconline.com

585-924-5900

CTC offers a wide array of 4-20 mA output solutions for industrial applications. CTC's standard 4-20 mA loop-powered vibration sensors are available with velocity as well as acceleration output measurement options. CTC's loop-powered sensor line also includes a dual output option, with both 4-20 mA output and dynamic output configurations in one sensor. Other options include 24 VDC powered transmitters that power standard IEPE accelerometers and convert the vibration to a powered 4-20 mA signal. These transmitters also offer a 4-20 mA output for temperature when coupled with CTC dual output vibration and temperature sensors.

### Velocity & Acceleration

LP200 Series sensors for velocity and LP300 Series sensors for acceleration come in top or side exit connector, integral cable, and armored integral cable options. LP400 Series sensors for dual output come in top, integral, and armored integral exit options.



**TOP EXIT**



**TOP EXIT**



**TOP EXIT**



**SIDE EXIT**

**LP200**  
Velocity  
output



**SIDE EXIT**

**LP300**  
Acceleration  
output



**INTEGRAL OPTIONS**

**LP400**  
Dual output



CTC's Signal Conditioner Enclosures are turnkey solutions, which come fully populated with signal conditioners, power supply, and terminal blocks for sensor terminations. The signal conditioners are available pre-configured based on customer-specific requirements. Terminal blocks are provided for easy sensor terminations. These terminal blocks are pre-wired to the signal conditioners, and the outputs from the signal conditioners are wired to terminal blocks for integration into PLC/DCS systems.



**SC200 SERIES**  
Field configurable  
vibration and  
temperature signal  
conditioners



**SC300 SERIES**  
USB configurable,  
dual channel vibration  
plus temperature



**SC900 SERIES**  
Hazardous location  
approved, 4-20 mA  
vibration transmitters

---

## Signal Conditioner Enclosures



**XE150**  
1-8 channel  
enclosure



**MVR1000**  
1-4 channel  
enclosure



**XE550 SERIES**  
1-8 channel  
enclosure with up  
to 16 total IP based  
outputs



## PROXIMITY PROBES

CTC offers a complete line of proximity probes systems designed and built to endure the harshest industrial environments. Proximity probes systems are available with probe tip sizes in 8mm, 11mm, 25mm, and FFV 5mm diameters with Bently compatible options. The variety of probe sizes offered allows accurate and precise machinery measurements for applications involving radial dynamic, axial rotor position, and thermal case expansion measurements.



### PROBE TIP OPTIONS

FFV 5mm, 8mm, 11mm, 25mm

Standard and armor cable options available

PRO line & Bently compatible offerings

## Complete Your Prox Probe Assembly



**DRIVERS**

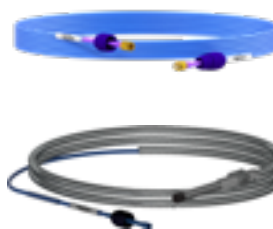

**EXTENSION  
CABLES**

## Proximity Probe Accessories



### ENCLOSURES

Fiberglass and stainless  
steel enclosures  
1-6 channels

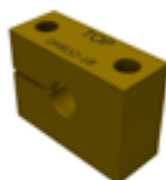

### MOUNTING BLOCKS



### REVERSE MOUNT HOUSING



Backed by our Best-in-Class Warranty!

[www.ctconline.com](http://www.ctconline.com)

585-924-5900

## Wireless Vibration Transmitter



### WA100-BT

Bluetooth® Low Energy 5.0

Compatible with AC312/AC314 low power accelerometers

Captures a dynamic signal at a user specified sampling rate for a user specified sample time

Estimated 5+ years of battery life when taking 2 or fewer scheduled measurements daily

User configurable 1 - 40ks/sec,  
F-max = 15,652 Hz ((40ks/s) / 2.56)

Completely customizable monitoring software —  
No subscription required

## MOLDED ACCELEROMETERS

### Lightweight Molded Accelerometer



#### MCB211

High frequency  
10 mV/g



#### MDB211

High frequency  
50 mV/g



#### MEB210

General purpose  
100 mV/g



#### MEB211

High frequency  
100 mV/g

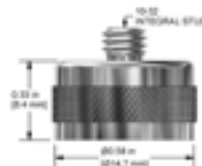

#### SUGGESTED MOUNTING HARDWARE

MH154-1B  
Flat surface  
pull strength:  
15lbs/7kg



Backed by our Best-in-Class Warranty!

www.ctconline.com

585-924-5900



VIBRATION ANALYSIS HARDWARE



PROTECTION & RELIABILITY INSTRUMENTS

**7939 Rae Boulevard • Victor, NY 14564**

**585-924-5900**

**[www.ctconline.com](http://www.ctconline.com)**

WHEN RELIABILITY MATTERS  
CONNECT TO CONFIDENCE