

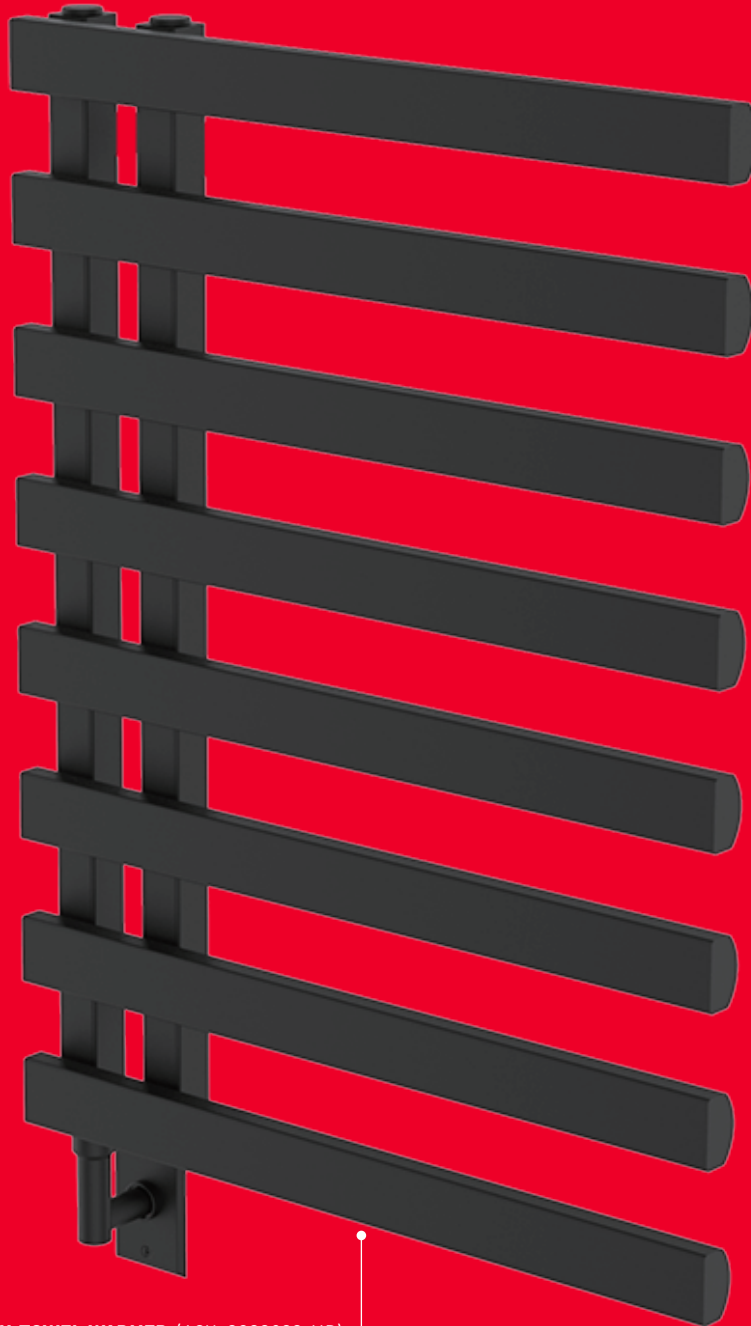

Towel Warmers™



ATLANTIC CITY TOWEL WARMER (ACY-0800600-MB)
SEE PAGE 8

THREE NEW SERIES FOR 2020-2021

-ATLANTIC CITY -HOUSTON -LAS VEGAS

11 DIFFERENT SERIES

ATLANTA, ATLANTIC CITY, AUGUSTA, BOSTON, CHICAGO, DALLAS, DENVER, HOUSTON, LAS VEGAS, SEATTLE, TUCSON

4 FINISHES AVAILABLE

POLISHED CHROME, BRUSHED NICKEL, POLISHED NICKEL, MATTE BLACK

10 YEAR BODY, 5 YEAR ELECTRICAL WARRANTY

(SEE PAGE 30)

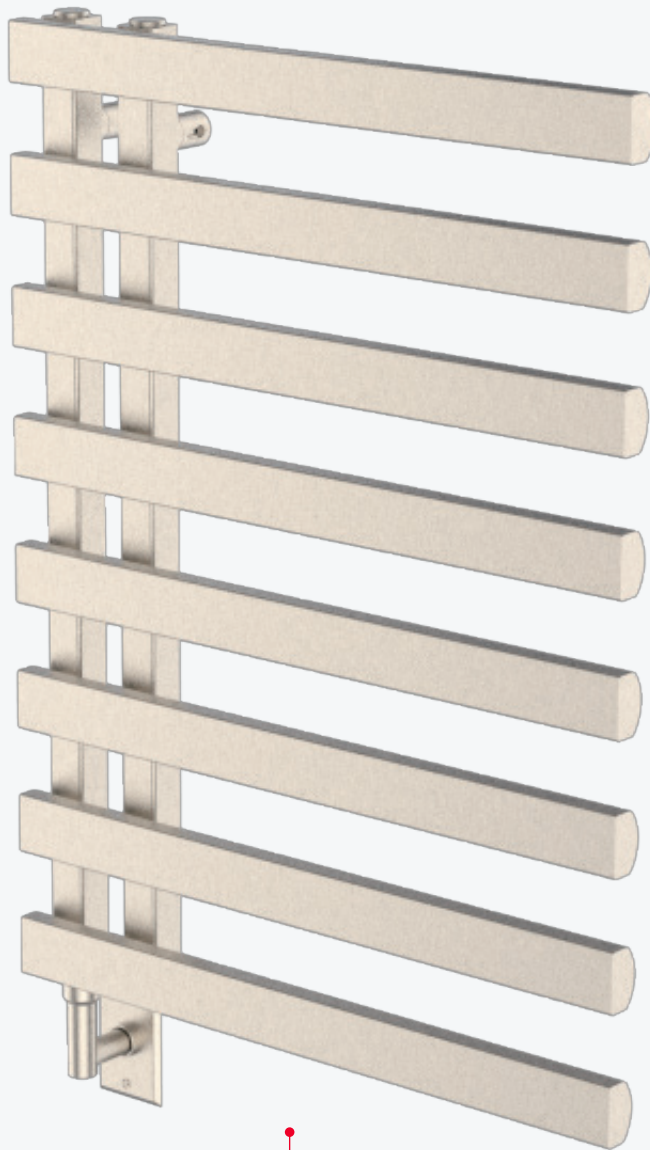

ATLANTIC CITY TOWEL WARMER (ACY-0800600-BN)

SEE PAGE 8

ELECTRICAL OIL FILLED
HARDWARE KIT INCLUDED
INSTALLATION KIT INCLUDED

TABLE OF CONTENTS



	ATLANTA SERIES	6 - 7
NEW	ATLANTIC CITY SERIES	8 - 9
	AUGUSTA SERIES	10 - 11
	BOSTON SERIES	12 - 13
	CHICAGO SERIES	14 - 15
	DALLAS SERIES	16 - 17
	DENVER SERIES	18 - 19
NEW	HOUSTON SERIES	20 - 21
NEW	LAS VEGAS SERIES	22 - 23
	SEATTLE SERIES	24 - 25
	TUCSON SERIES	26 - 27
	TIMERS	28

WELCOME TO VERNON



Vernon Towel Warmers combines luxury and design to create a unique product for EVERYONE. Each Series offers YOU the opportunity to enjoy an exclusive spa experience every day in your own home. With eleven different Series, and two sizes per Series, Vernon Towel Warmers has the size you need, and the style you want. Stocked in Chrome, Matte Black, Brushed Nickel and Polished Nickel, your daily trip to the spa has never been so easy. Check our other key features below:

- 11 series
- 2 sizes per collection
- 20"-24" wide products available
- Hardwire Kit included
- 10 Year Body, 5 Year electrical warranty

For more information regarding our products and pricing, please contact your local representative or contact Vernon Towel Warmers Inc. at **1-604-628-0567** or **orders@vernontowelwarmers.com**. Thank you for considering Vernon Towel Warmers Inc.

STOCKED FINISHES BY SERIES

SERIES	POLISHED CHROME	BRUSHED NICKEL	POLISHED NICKEL	MATTE BLACK	SERIES PAGE #
ATLANTA	●	●	●	●	6 - 7
ATLANTIC CITY NEW	●	●	●	●	8 - 9
AUGUSTA	●		●	●	10 - 11
BOSTON	●	●	●	●	12 - 13
CHICAGO	●		●	●	14 - 15
DALLAS	●	●		●	16 - 17
DENVER	●	●	●	●	18 - 19
HOUSTON NEW	●	●	●	●	20 - 21
LAS VEGAS NEW	●	●	●	●	22 - 23
SEATTLE	●	●	●	●	24 - 25
TUCSON	●	●	●		26 - 27

ATLANTA SERIES —
ATL-0800600

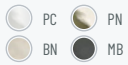

ATLANTIC CITY SERIES —
ACY-0800600



AUGUSTA SERIES —
AGS-0800500

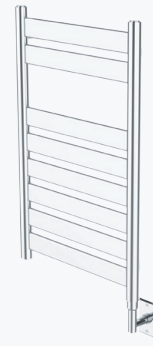

BOSTON SERIES —
BOS-0800500



CHICAGO SERIES —
ORD-0800500

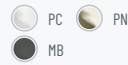

DALLAS SERIES —
DAL-0800600



DENVER SERIES —
DEN-0800600



HOUSTON SERIES —
HOU-0800600

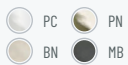

LAS VEGAS SERIES —
LAS-0800600

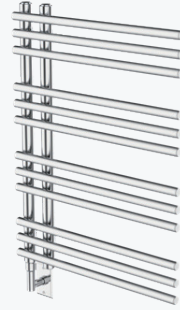

SEATTLE SERIES —
SEA-0800600

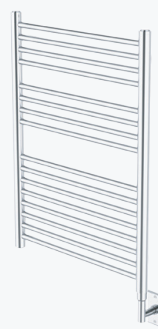

TUCSON SERIES —
TUS-0920600

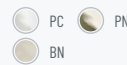
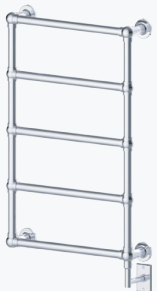

THE COMPLETE
**VERNON TOWEL
WARMER RANGE**

ATLANTA SERIES

ATLANTA

ATLANTIC CITY

AUGUSTA

BOSTON

CHICAGO

DALLAS

ATL-0800600-PC

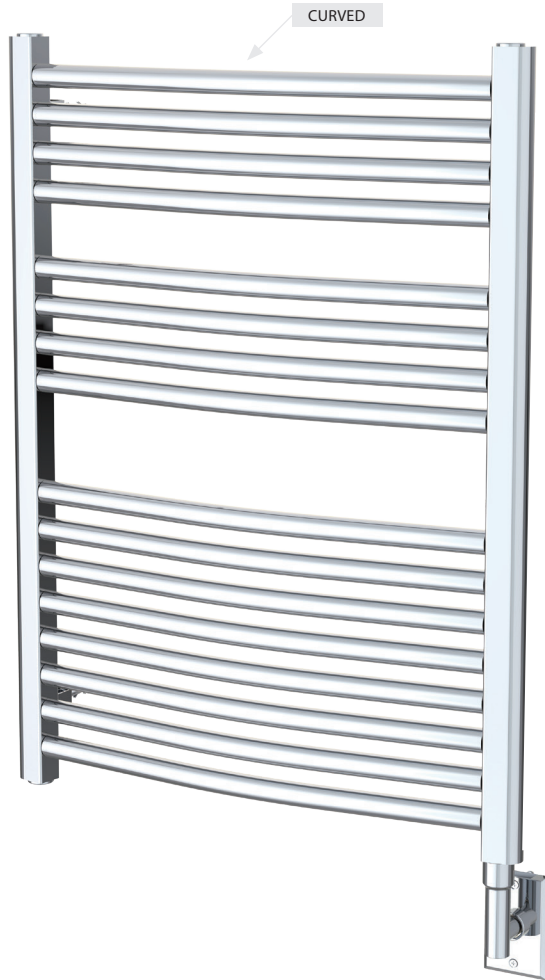

FEATURES

- WALL MOUNTED
 - HARDWIRE INSTALLATION KIT
 - MOUNTING INSTRUCTIONS
 - ALL ELECTRIC AND OIL FILLED
 - COVER PLATES
- TIMERS AVAILABLE SEPARATELY (NOT INCLUDED)

FINISHES IN STOCK

- POLISHED CHROME (PC)
- BRUSHED NICKEL (BN)
- POLISHED NICKEL (PN)
- MATTE BLACK (MB)

SIZES

- 800 x 600 MM
- 1200 x 600 MM

WARRANTY

10 Year Body Warranty
5 Year Electrical Warranty

Corps de 10 ans
Garante électrique de 5 ans

Cuerpo de 10 años
5 años de garantía eléctrica

TIMERS AVAILABLE



VPT24-1PZ



DDS15-BDZ

* See page 28 for Timer Pricing

Product Code	Finishes	Sizes (mm)		Sizes (Inches)		Output (Watts/BTU)	Element Size	Number of Elements
		Height	Width	Height	Width			
ATL-0800600	PC, BN, PN, MB	800	600	31.50	23.62	349 / 1191	150W	16
ATL-1200600	PC, BN, PN, MB	1200	600	47.24	23.62	523 / 1786	300W	24

ATLANTA SERIES



ATLANTA

ATLANTIC CITY

AUGUSTA

BOSTON

CHICAGO

DALLAS

	PRODUCT CODE	NAME	FINISH	PRICE
--	--------------	------	--------	-------

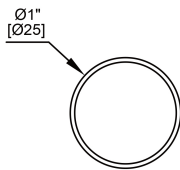
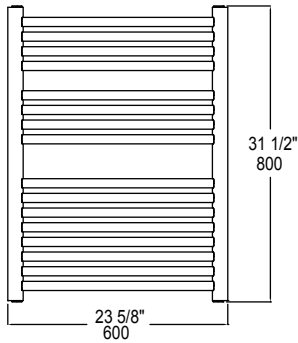

HORIZONTAL TUBE

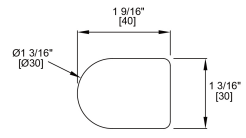

VERTICAL TUBE

ATL-0800600-PC	Towel Warmer	Polished Chrome	\$500
----------------	--------------	-----------------	-------

ATL-0800600-BN	Towel Warmer	Brushed Nickel	\$600
----------------	--------------	----------------	-------

ATL-0800600-PN	Towel Warmer	Polished Nickel	\$600
----------------	--------------	-----------------	-------

ATL-0800600-MB	Towel Warmer	Matte Black	\$500
----------------	--------------	-------------	-------

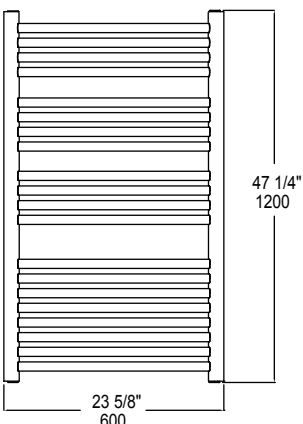

ATL-1200600-PC	Towel Warmer	Polished Chrome	\$830
----------------	--------------	-----------------	-------

ATL-1200600-BN	Towel Warmer	Brushed Nickel	\$995
----------------	--------------	----------------	-------

ATL-1200600-PN	Towel Warmer	Polished Nickel	\$995
----------------	--------------	-----------------	-------

ATL-1200600-MB	Towel Warmer	Matte Black	\$855
----------------	--------------	-------------	-------



AVAILABLE FINISHES

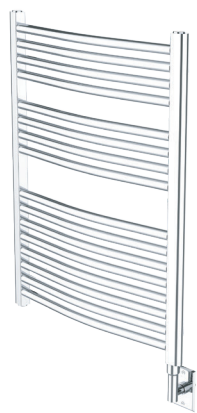

Polished Chrome (PC)



Brushed Nickel (BN)



Polished Nickel (PN)

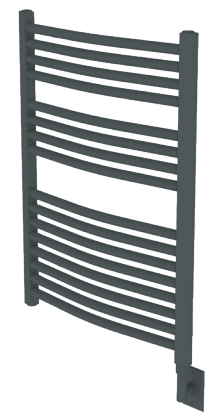

Matte Black (MB)

ATLANTIC CITY SERIES

ATLANTA

ATLANTIC CITY

AUGUSTA

BOSTON

CHICAGO

DALLAS

ACY-0800600-PC

NEW

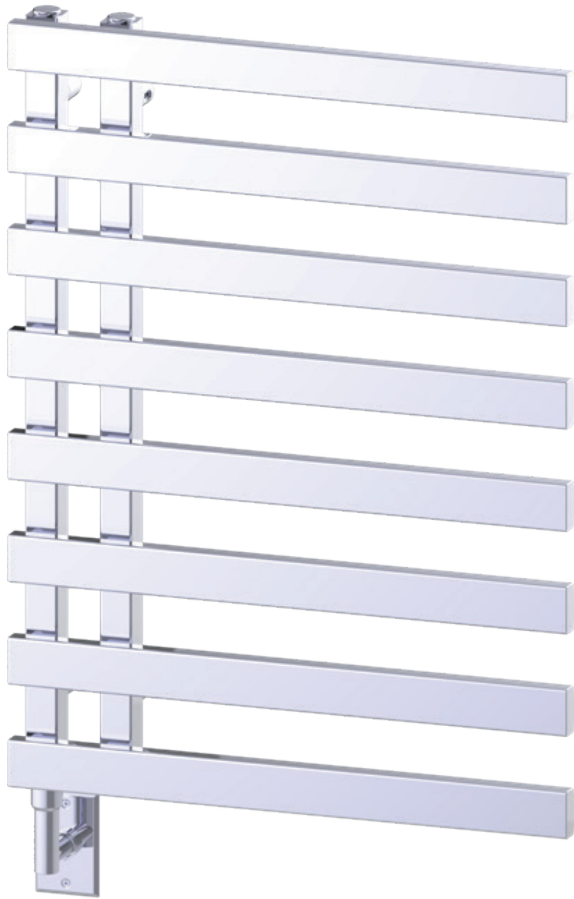

FEATURES

- WALL MOUNTED
 - HARDWIRE INSTALLATION KIT
 - MOUNTING INSTRUCTIONS
 - ALL ELECTRIC AND OIL FILLED
 - COVER PLATES
- TIMERS AVAILABLE SEPARATELY (NOT INCLUDED)

FINISHES IN STOCK

- POLISHED CHROME (PC)
- BRUSHED NICKEL (BN)
- POLISHED NICKEL (PN)
- MATTE BLACK (MB)

SIZES

- 800 x 600 MM
- 1200 x 600 MM

WARRANTY

10 Year Body Warranty
5 Year Electrical Warranty

Corps de 10 ans
Garante électrique de 5 ans

Cuerpo de 10 años
5 años de garantía eléctrica

TIMERS AVAILABLE



VPT24-1PZ



DDS15-BDZ

* See page 28 for Timer Pricing

Product Code	Finishes	Sizes (mm)		Sizes (Inches)		Output (Watts/BTU)	Element Size	Number of Elements
		Height	Width	Height	Width			
ACY-0800600	PC, BN, PN, MB	800	600	31.50	23.62	440 / 1501	150W	8
ACY-1200600	PC, BN, PN, MB	1200	600	47.24	23.62	522 / 1781	300W	11

ATLANTIC CITY SERIES



ATLANTA

ATLANTIC CITY

AUGUSTA

BOSTON

CHICAGO

DALLAS

PRODUCT	NAME	FINISH	PRICE
---------	------	--------	-------

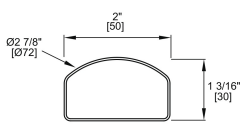
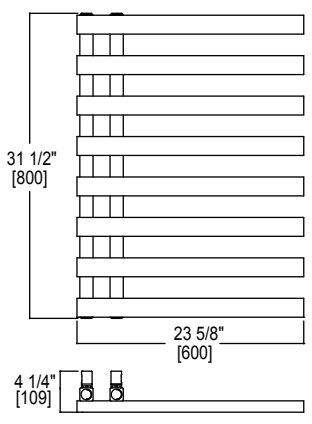

HORIZONTAL TUBE

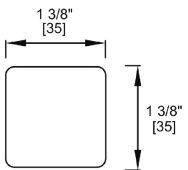

VERTICAL TUBE

ACY-0800600-PC	Towel Warmer	Polished Chrome	\$890
ACY-0800600-BN	Towel Warmer	Brushed Nickel	\$990
ACY-0800600-PN	Towel Warmer	Polished Nickel	\$990
ACY-0800600-MB	Towel Warmer	Matte Black	\$930

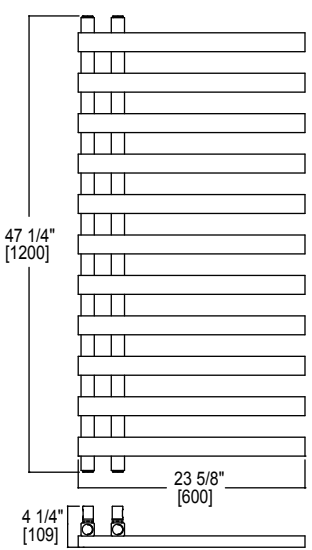

ACY-1200600-PC	Towel Warmer	Polished Chrome	\$1040
ACY-1200600-BN	Towel Warmer	Brushed Nickel	\$1250
ACY-1200600-PN	Towel Warmer	Polished Nickel	\$1250
ACY-1200600-MB	Towel Warmer	Matte Black	\$1070

AVAILABLE FINISHES

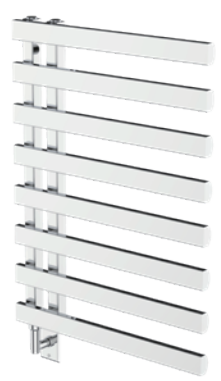

Polished Chrome (PC)

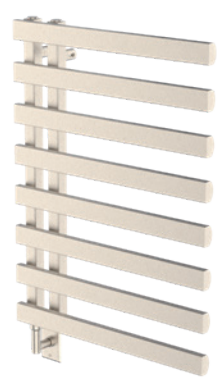

Brushed Nickel (BN)

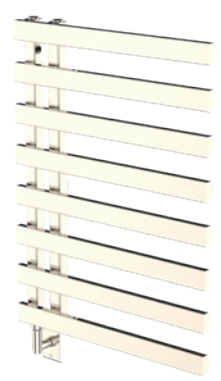

Polished Nickel (PN)

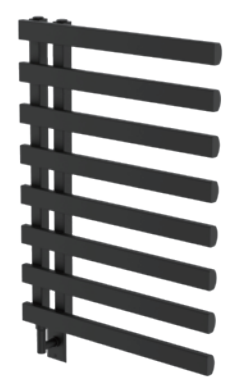

Matte Black (MB)

AUGUSTA SERIES

ATLANTA

ATLANTIC CITY

AUGUSTA

BOSTON

CHICAGO

DALLAS

AGS-0800500-PC



FEATURES

- WALL MOUNTED
 - HARDWIRE INSTALLATION KIT
 - MOUNTING INSTRUCTIONS
 - ALL ELECTRIC AND OIL FILLED
 - COVER PLATES
- TIMERS AVAILABLE SEPARATELY (NOT INCLUDED)

FINISHES IN STOCK

- POLISHED CHROME (PC)
- POLISHED NICKEL (PN)
- MATTE BLACK (MB)

SIZES

- 800 x 500MM
- 1200 x 500MM

WARRANTY

10 Year Body Warranty
5 Year Electrical Warranty

Corps de 10 ans
Garante électrique de 5 ans

Cuerpo de 10 años
5 años de garantía eléctrica

TIMERS AVAILABLE



VPT24-1PZ



DDS15-BDZ

* See page 28 for Timer Pricing

Product Code	Finishes	Sizes (mm)		Sizes (Inches)		Output (Watts/BTU)	Element Size	Number of Elements
		Height	Width	Height	Width			
AGS-0800500	PC, PN, MB	800	500	31.50	19.69	262 / 895	150W	8
AGS-1200500	PC, PN, MB	1200	500	47.24	19.69	393 / 1342	300W	12

AUGUSTA SERIES



ATLANTA

ATLANTIC CITY

AUGUSTA

BOSTON

CHICAGO

DALLAS

PRODUCT CODE	NAME	FINISH	PRICE
--------------	------	--------	-------

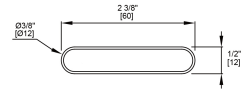
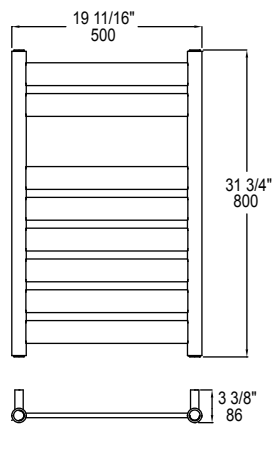

HORIZONTAL TUBE

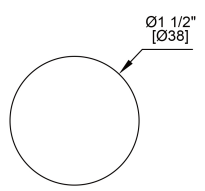

VERTICAL TUBE

AGS-0800500-PC	Towel Warmer	Polished Chrome	\$795
AGS-0800500-PN	Towel Warmer	Polished Nickel	\$975
AGS-0800500-MB	Towel Warmer	Matte Black	\$820

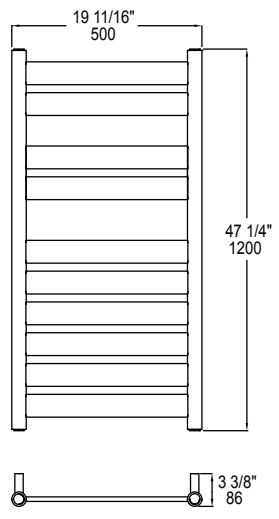

AGS-1200500-PC	Towel Warmer	Polished Chrome	\$950
AGS-1200500-PN	Towel Warmer	Polished Nickel	\$1275
AGS-1200500-MB	Towel Warmer	Matte Black	\$975

AVAILABLE FINISHES

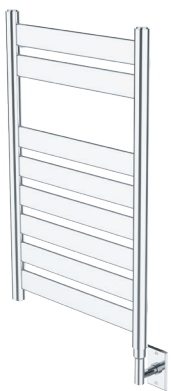

Polished Chrome (PC)



Polished Nickel (PN)

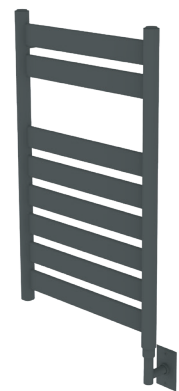

Matte Black (MB)

BOS-0800500-PC

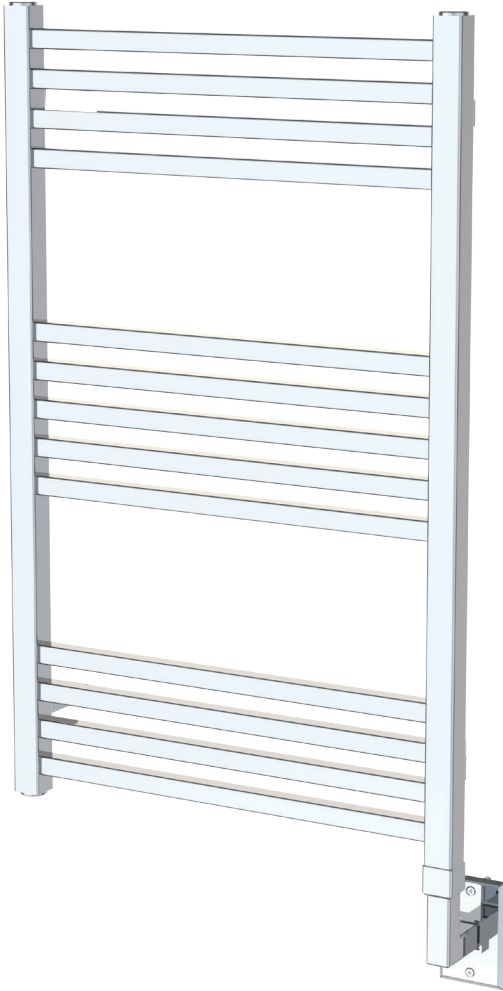

FEATURES

- WALL MOUNTED
 - HARDWIRE INSTALLATION KIT
 - MOUNTING INSTRUCTIONS
 - ALL ELECTRIC AND OIL FILLED
 - COVER PLATES
- TIMERS AVAILABLE SEPARATELY (NOT INCLUDED)

FINISHES IN STOCK

- POLISHED CHROME (PC)
- BRUSHED NICKEL (BN)
- POLISHED NICKEL (PN)
- MATTE BLACK (MB)

SIZES

- 800 x 500MM
- 1200 x 600MM

WARRANTY

10 Year Body Warranty
5 Year Electrical Warranty

Corps de 10 ans
Garante électrique de 5 ans

Cuerpo de 10 años
5 años de garantía eléctrica

TIMERS AVAILABLE



VPT24-1PZ



DDS15-BDZ

* See page 28 for Timer Pricing

Product Code	Finishes	Sizes (mm)		Sizes (Inches)		Output (Watts/BTU)	Element Size	Number of Elements
		Height	Width	Height	Width			
BOS-0800500	PC, BN, PN, MB	800	500	31.50	19.69	255 / 870	150W	13
BOS-1200600	PC, BN, PN, MB	1200	600	47.24	23.62	452 / 1543	300W	20

BOSTON SERIES



PRODUCT CODE	NAME	FINISH	PRICE
--------------	------	--------	-------

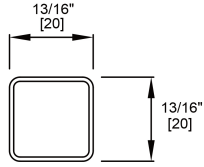
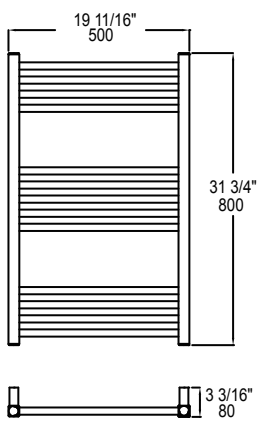

HORIZONTAL TUBE

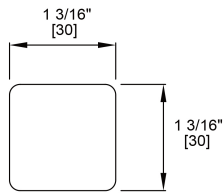

VERTICAL TUBE

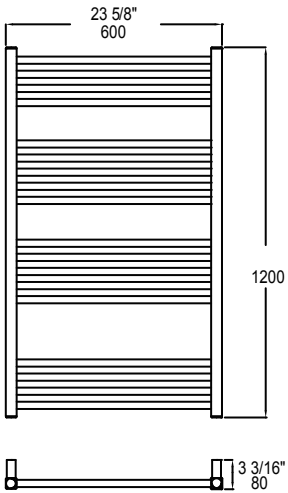

BOS-0800500-PC	Towel Warmer	Polished Chrome	\$500
BOS-0800500-BN	Towel Warmer	Brushed Nickel	\$875
BOS-0800500-PN	Towel Warmer	Polished Nickel	\$875
BOS-0800500-MB	Towel Warmer	Matte Black	\$500

BOS-1200600-PC	Towel Warmer	Polished Chrome	\$950
BOS-1200600-BN	Towel Warmer	Brushed Nickel	\$1125
BOS-1200600-PN	Towel Warmer	Polished Nickel	\$1125
BOS-1200600-MB	Towel Warmer	Matte Black	\$975

AVAILABLE FINISHES



Polished Chrome (PC)



Brushed Nickel (BN)



Polished Nickel (PN)

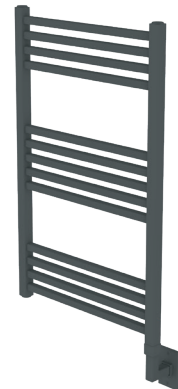

Matte Black (MB)

CHICAGO SERIES

ATLANTA

ATLANTIC CITY

AUGUSTA

BOSTON

CHICAGO

DALLAS

ORD-0800500-PC



FEATURES

- WALL MOUNTED
 - HARDWIRE INSTALLATION KIT
 - MOUNTING INSTRUCTIONS
 - ALL ELECTRIC AND OIL FILLED
 - COVER PLATES
- TIMERS AVAILABLE SEPARATELY (NOT INCLUDED)

FINISHES IN STOCK

- POLISHED CHROME (PC)
- POLISHED NICKEL (PN)
- MATTE BLACK (MB)

SIZES

- 800 x 500MM
- 1200 x 600MM

WARRANTY

10 Year Body Warranty
 5 Year Electrical Warranty

Corps de 10 ans
 Garante électrique de 5 ans

Cuerpo de 10 años
 5 años de garantía eléctrica

TIMERS AVAILABLE



VPT24-1PZ



DDS15-BDZ

* See page 28 for Timer Pricing

Product Code	Finishes	Sizes (mm)		Sizes (Inches)		Output (Watts/BTU)	Element Size	Number of Elements
		Height	Width	Height	Width			
ORD-0800500	PC, PN, MB	800	500	31.50	19.69	254 / 866	150W	13
ORD-1200600	PC, PN, MB	1200	600	47.24	23.62	484 / 1651	300W	22

CHICAGO SERIES



PRODUCT CODE	NAME	FINISH	PRICE
--------------	------	--------	-------

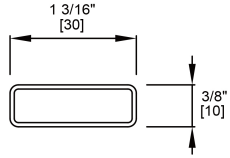
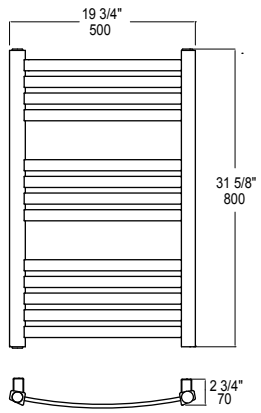

HORIZONTAL TUBE

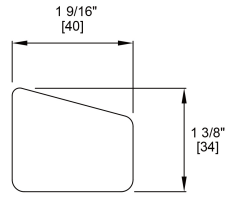

VERTICAL TUBE

ORD-0800500-PC	Towel Warmer	Polished Chrome	\$775
ORD-0800500-PN	Towel Warmer	Polished Nickel	\$960
ORD-0800500-MB	Towel Warmer	Matte Black	\$800

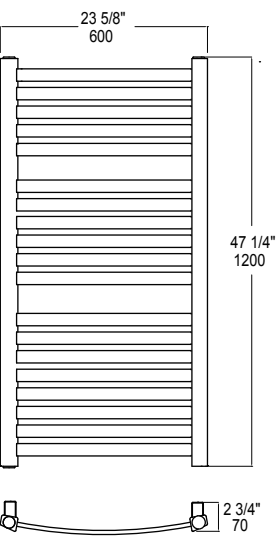

ORD-1200600-PC	Towel Warmer	Polished Chrome	\$960
ORD-1200600-PN	Towel Warmer	Polished Nickel	\$1200
ORD-1200600-MB	Towel Warmer	Matte Black	\$985

— AVAILABLE FINISHES



Polished Chrome (PC)



Polished Nickel (PN)

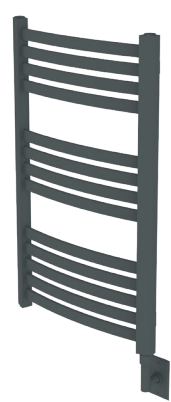

Matte Black (MB)

ATLANTA

ATLANTIC CITY

AUGUSTA

BOSTON

CHICAGO

DALLAS

DAL-0800600-PC



FEATURES

- WALL MOUNTED
 - HARDWIRE INSTALLATION KIT
 - MOUNTING INSTRUCTIONS
 - ALL ELECTRIC AND OIL FILLED
 - COVER PLATES
- TIMERS AVAILABLE SEPARATELY (NOT INCLUDED)

FINISHES IN STOCK

- POLISHED CHROME (PC)
- BRUSHED NICKEL (BN)
- MATTE BLACK (MB)

SIZES

- 800 x 600MM
- 1200 x 600MM

WARRANTY

10 Year Body Warranty
 5 Year Electrical Warranty

Corps de 10 ans
 Garante électrique de 5 ans

Cuerpo de 10 años
 5 años de garantía eléctrica

TIMERS AVAILABLE



VPT24-1PZ



DDS15-BDZ

* See page 28 for Timer Pricing

Product Code	Finishes	Sizes (mm)		Sizes (Inches)		Output (Watts/BTU)	Element Size	Number of Elements
		Height	Width	Height	Width			
DAL-0800600	PC, BN, MB	800	600	31.50	23.62	293 / 1000	150W	13
DAL-1200600	PC, BN, MB	1200	600	47.24	23.62	448 / 1528	300W	20

DALLAS SERIES



ATLANTA

ATLANTIC CITY

AUGUSTA

BOSTON

CHICAGO

DALLAS

	PRODUCT CODE	NAME	FINISH	PRICE
--	--------------	------	--------	-------

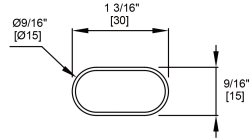
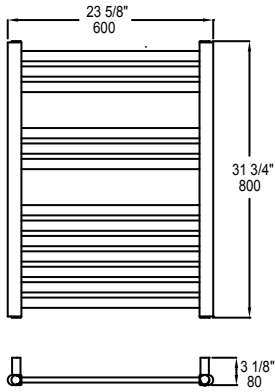

HORIZONTAL TUBE

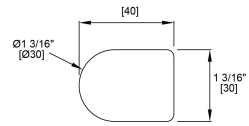

VERTICAL TUBE

DAL-0800600-PC	Towel Warmer	Polished Chrome	\$790
----------------	--------------	-----------------	-------

DAL-0800600-BN	Towel Warmer	Brushed Nickel	\$930
----------------	--------------	----------------	-------

DAL-0800600-MB	Towel Warmer	Matte Black	\$815
----------------	--------------	-------------	-------

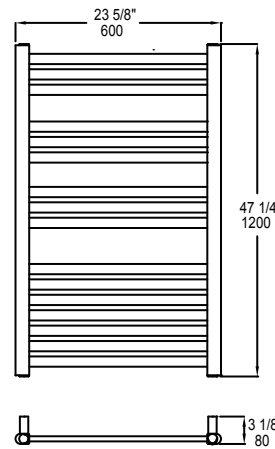

DAL-1200600-PC	Towel Warmer	Polished Chrome	\$950
----------------	--------------	-----------------	-------

DAL-1200600-BN	Towel Warmer	Brushed Nickel	\$1100
----------------	--------------	----------------	--------

DAL-1200600-MB	Towel Warmer	Matte Black	\$975
----------------	--------------	-------------	-------

AVAILABLE FINISHES



Polished Chrome (PC)



Brushed Nickel (BN)



Matte Black (MB)

DEN-0800600-PC

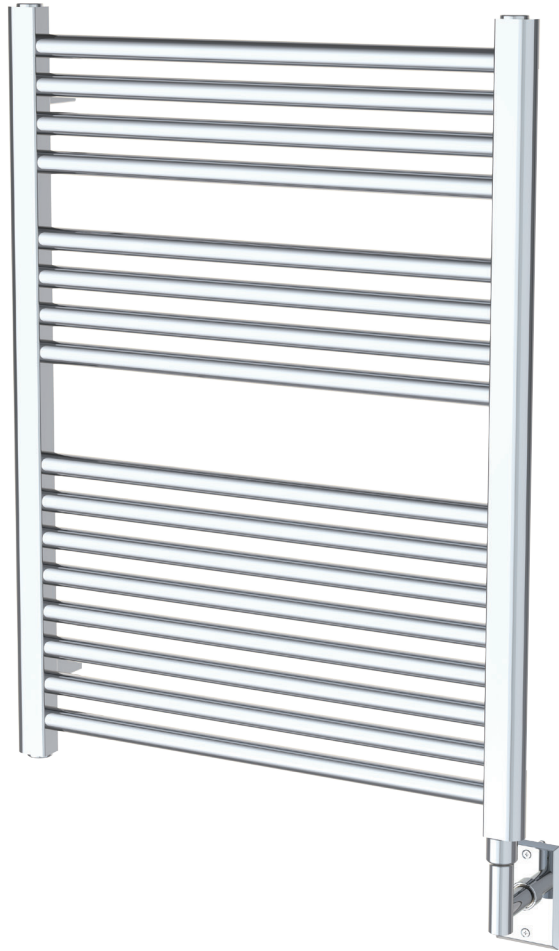

FEATURES

- WALL MOUNTED
 - HARDWIRE INSTALLATION KIT
 - MOUNTING INSTRUCTIONS
 - ALL ELECTRIC AND OIL FILLED
 - COVER PLATES
- TIMERS AVAILABLE SEPARATELY (NOT INCLUDED)

FINISHES IN STOCK

- POLISHED CHROME (PC)
- BRUSHED NICKEL (BN)
- POLISHED NICKEL (PN)
- MATTE BLACK (MB)

SIZES

- 800 x 600 MM
- 1200 x 600 MM

WARRANTY

10 Year Body Warranty
 5 Year Electrical Warranty

Corps de 10 ans
 Garante électrique de 5 ans

Cuerpo de 10 años
 5 años de garantía eléctrica

TIMERS AVAILABLE



VPT24-1PZ



DDS15-BDZ

* See page 28 for Timer Pricing

Product Code	Finishes	Sizes (mm)		Sizes (Inches)		Output (Watts/BTU)	Element Size	Number of Elements
		Height	Width	Height	Width			
DEN-0800600	PC, BN, PN, MB	800	600	31.50	23.62	347 / 1184	150W	16
DEN-1200600	PC, BN, PN, MB	1200	600	47.24	23.62	520 / 1776	300W	24

DENVER SERIES



PRODUCT	NAME	FINISH	PRICE
---------	------	--------	-------

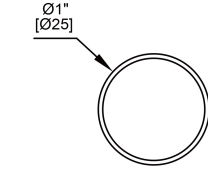
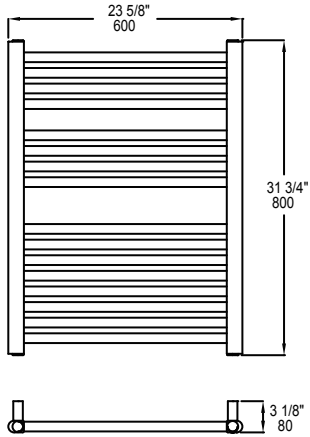

HORIZONTAL TUBE

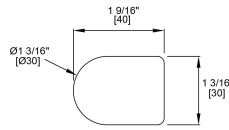

VERTICAL TUBE

DEN-0800600-PC	Towel Warmer	Polished Chrome	\$790
----------------	--------------	-----------------	-------

DEN-0800600-BN	Towel Warmer	Brushed Nickel	\$975
----------------	--------------	----------------	-------

DEN-0800600-PN	Towel Warmer	Polished Nickel	\$975
----------------	--------------	-----------------	-------

DEN-0800600-MB	Towel Warmer	Matte Black	\$815
----------------	--------------	-------------	-------

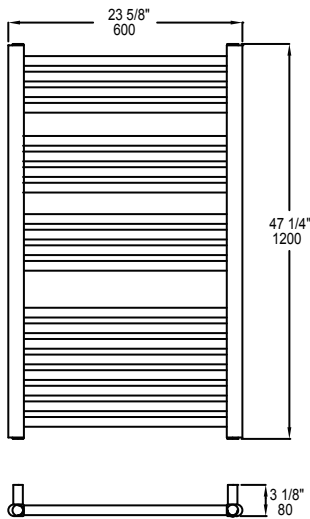

DEN-1200600-PC	Towel Warmer	Polished Chrome	\$890
----------------	--------------	-----------------	-------

DEN-1200600-BN	Towel Warmer	Brushed Nickel	\$1150
----------------	--------------	----------------	--------

DEN-1200600-PN	Towel Warmer	Polished Nickel	\$1150
----------------	--------------	-----------------	--------

DEN-1200600-MB	Towel Warmer	Matte Black	\$915
----------------	--------------	-------------	-------

AVAILABLE FINISHES

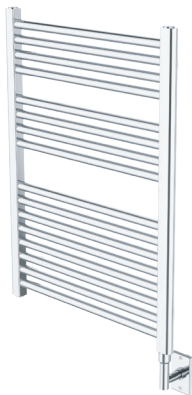

Polished Chrome (PC)



Brushed Nickel (BN)



Polished Nickel (PN)



Matte Black (MB)

HOU-0800600-PC

NEW



FEATURES

- WALL MOUNTED
 - HARDWIRE INSTALLATION KIT
 - MOUNTING INSTRUCTIONS
 - ALL ELECTRIC AND OIL FILLED
 - COVER PLATES
- TIMERS AVAILABLE SEPARATELY (NOT INCLUDED)

FINISHES IN STOCK

- POLISHED CHROME (PC)
- BRUSHED NICKEL (BN)
- POLISHED NICKEL (PN)
- MATTE BLACK (MB)

SIZES

- 800 x 600 MM
- 1200 x 600 MM

WARRANTY

10 Year Body Warranty
5 Year Electrical Warranty

Corps de 10 ans
Garante électrique de 5 ans

Cuerpo de 10 años
5 años de garantía eléctrica

TIMERS AVAILABLE



VPT24-1PZ



DDS15-BDZ

* See page 28 for Timer Pricing

Product Code	Finishes	Sizes (mm)		Sizes (Inches)		Output (Watts/BTU)	Element Size	Number of Elements
		Height	Width	Height	Width			
HOU-0800600	PC, BN, PN, MB	800	600	31.50	23.62	332 / 1132	150W	11
HOU-1200600	PC, BN, PN, MB	1200	600	47.24	23.62	486 / 1659	300W	16

HOUSTON SERIES



PRODUCT	NAME	FINISH	PRICE
---------	------	--------	-------

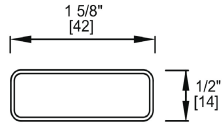
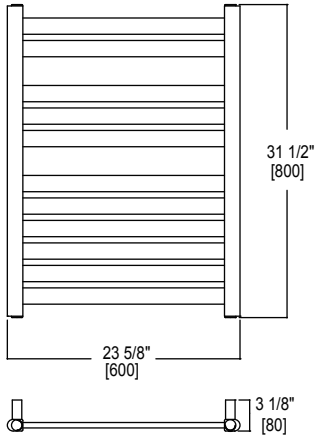

HORIZONTAL TUBE

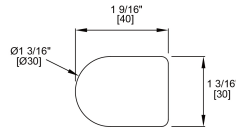

VERTICAL TUBE

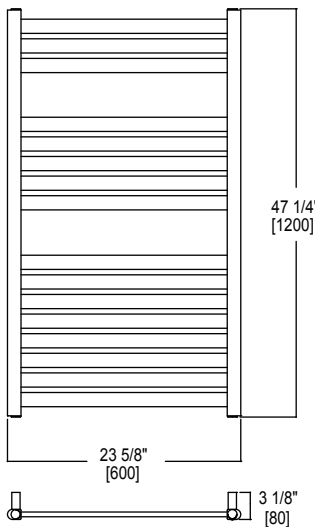

HOU-0800600-PC Towel Warmer Polished Chrome \$825

HOU-0800600-BN Towel Warmer Brushed Nickel \$935

HOU-0800600-PN Towel Warmer Polished Nickel \$935

HOU-0800600-MB Towel Warmer Matte Black \$860

HOU-1200600-PC Towel Warmer Polished Chrome \$975

HOU-1200600-BN Towel Warmer Brushed Nickel \$1275

HOU-1200600-PN Towel Warmer Polished Nickel \$1275

HOU-1200600-MB Towel Warmer Matte Black \$1025

AVAILABLE FINISHES



Polished Chrome (PC)



Brushed Nickel (BN)

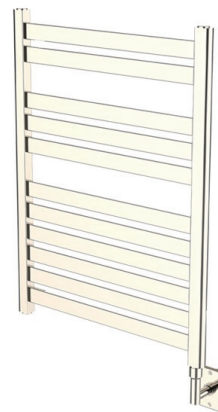

Polished Nickel (PN)



Matte Black (MB)

LAS-0800600-PC

NEW

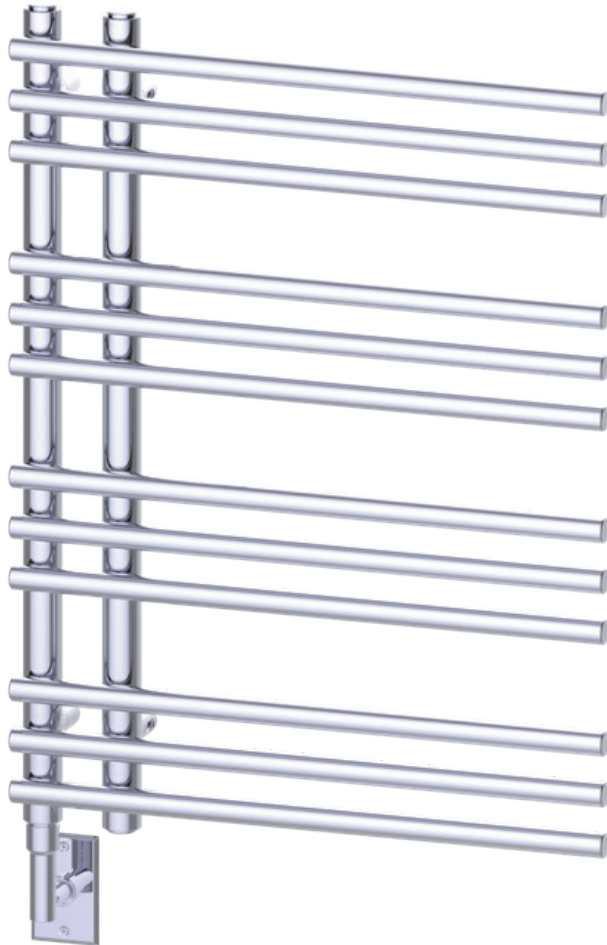

FEATURES

- WALL MOUNTED
 - HARDWIRE INSTALLATION KIT
 - MOUNTING INSTRUCTIONS
 - ALL ELECTRIC AND OIL FILLED
 - COVER PLATES
- TIMERS AVAILABLE SEPARATELY (NOT INCLUDED)

FINISHES IN STOCK

- POLISHED CHROME (PC)
- BRUSHED NICKEL (BN)
- POLISHED NICKEL (PN)
- MATTE BLACK (MB)

SIZES

- 800 x 600 MM
- 1200 x 600 MM

WARRANTY

10 Year Body Warranty
5 Year Electrical Warranty

Corps de 10 ans
Garante électrique de 5 ans

Cuerpo de 10 años
5 años de garantía eléctrica

TIMERS AVAILABLE



VPT24-1PZ



DDS15-BDZ

* See page 28 for Timer Pricing

Product Code	Finishes	Sizes (mm)		Sizes (Inches)		Output (Watts/BTU)	Element Size	Number of Elements
		Height	Width	Height	Width			
LAS-0800600	PC, BN, PN, MB	800	600	31.50	23.62	265 / 903	150W	12
LAS-1200600	PC, BN, PN, MB	1200	600	47.24	23.62	404 / 1378	300W	18

LAS VEGAS SERIES



PRODUCT	NAME	FINISH	PRICE
---------	------	--------	-------

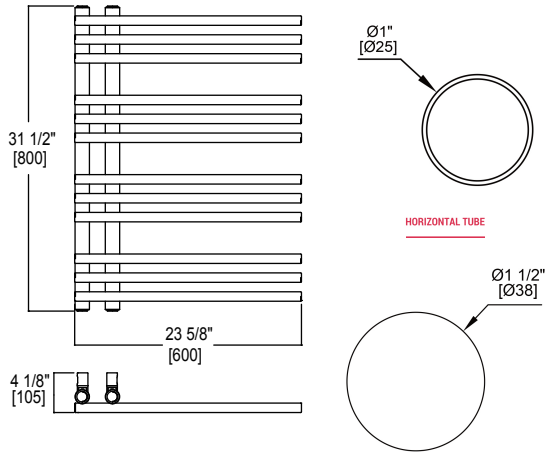

LAS-0800600-PC	Towel Warmer	Polished Chrome	\$875
----------------	--------------	-----------------	-------

LAS-0800600-BN	Towel Warmer	Brushed Nickel	\$975
----------------	--------------	----------------	-------

LAS-0800600-PN	Towel Warmer	Polished Nickel	\$975
----------------	--------------	-----------------	-------

LAS-0800600-MB	Towel Warmer	Matte Black	\$930
----------------	--------------	-------------	-------

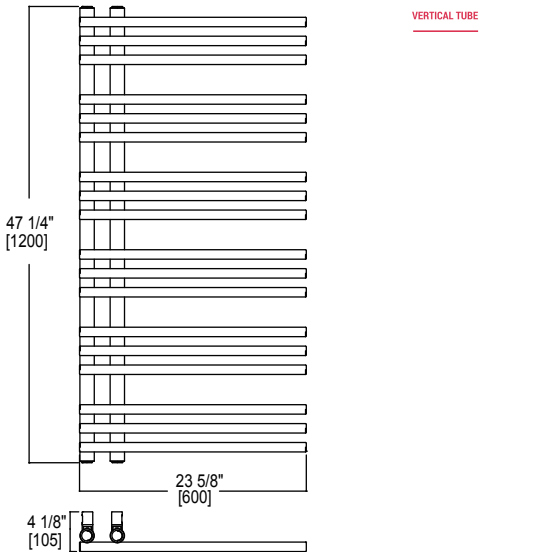

LAS-1200600-PC	Towel Warmer	Polished Chrome	\$930
----------------	--------------	-----------------	-------

LAS-1200600-BN	Towel Warmer	Brushed Nickel	\$1120
----------------	--------------	----------------	--------

LAS-1200600-PN	Towel Warmer	Polished Nickel	\$1120
----------------	--------------	-----------------	--------

LAS-1200600-MB	Towel Warmer	Matte Black	\$990
----------------	--------------	-------------	-------

AVAILABLE FINISHES

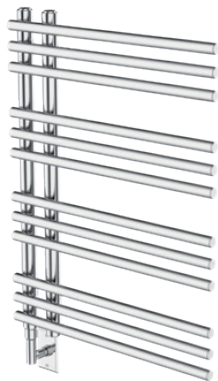

Polished Chrome (PC)

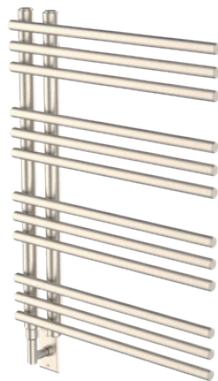

Brushed Nickel (BN)

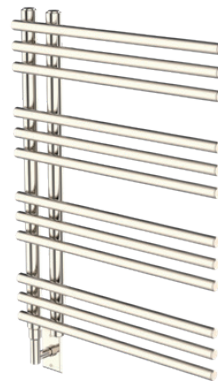

Polished Nickel (PN)

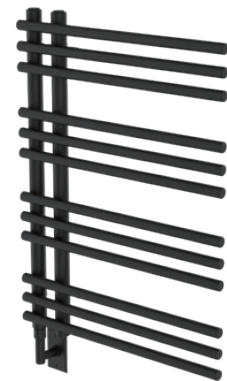

Matte Black (MB)

SEA-0800600-PC

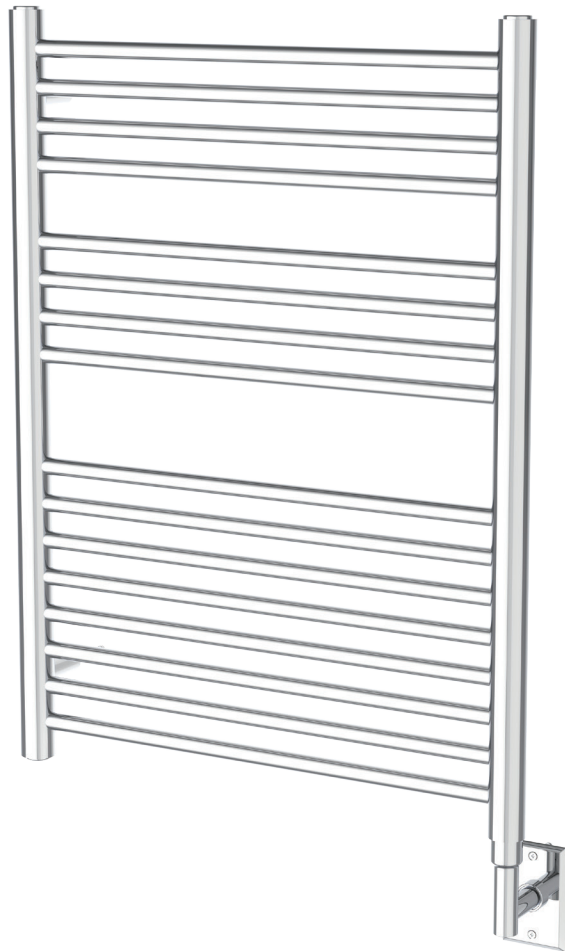

FEATURES

- WALL MOUNTED
 - HARDWIRE INSTALLATION KIT
 - MOUNTING INSTRUCTIONS
 - ALL ELECTRIC AND OIL FILLED
 - COVER PLATES
- TIMERS AVAILABLE SEPARATELY (NOT INCLUDED)

FINISHES IN STOCK

- POLISHED CHROME (PC)
- BRUSHED NICKEL (BN)
- POLISHED NICKEL (PN)
- MATTE BLACK (MB)

SIZES

- 800 x 600 MM
- 1200 x 600 MM

WARRANTY

10 Year Body Warranty
5 Year Electrical Warranty

Corps de 10 ans
Garante électrique de 5 ans

Cuerpo de 10 años
5 años de garantía eléctrica

TIMERS AVAILABLE



VPT24-1PZ



DDS15-BDZ

* See page 28 for Timer Pricing

Product Code	Finishes	Sizes (mm)		Sizes (Inches)		Output (Watts/BTU)	Element Size	Number of Elements
		Height	Width	Height	Width			
SEA-0800600	PC, BN, PN, MB	800	600	31.50	23.62	288 / 981	150W	16
SEA-1200600	PC, BN, PN, MB	1200	600	47.24	23.62	431 / 1472	300W	24

SEATTLE SERIES



PRODUCT CODE	NAME	FINISH	PRICE
--------------	------	--------	-------

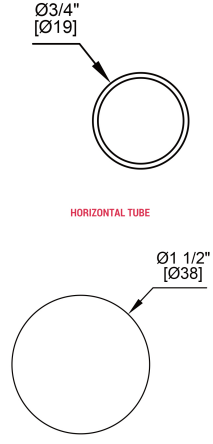
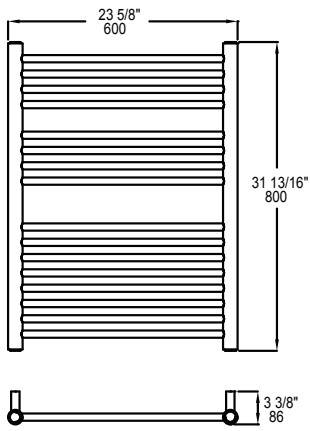

SEA-0800600-PC	Towel Warmer	Polished Chrome	\$810
SEA-0800600-BN	Towel Warmer	Brushed Nickel	\$975
SEA-0800600-PN	Towel Warmer	Polished Nickel	\$975
SEA-0800600-MB	Towel Warmer	Matte Black	\$835

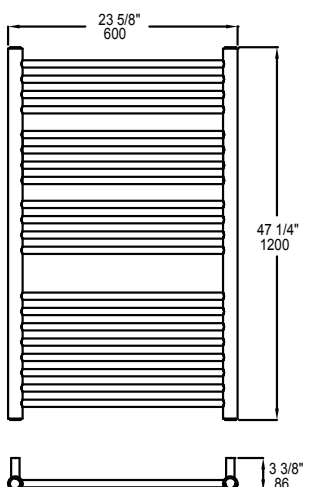

SEA-1200600-PC	Towel Warmer	Polished Chrome	\$925
SEA-1200600-BN	Towel Warmer	Brushed Nickel	\$1150
SEA-1200600-PN	Towel Warmer	Polished Nickel	\$1150
SEA-1200600-MB	Towel Warmer	Matte Black	\$950

— AVAILABLE FINISHES

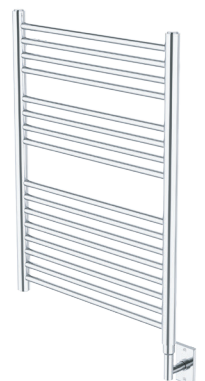

Polished Chrome (PC)



Brushed Nickel (BN)



Polished Nickel (PN)

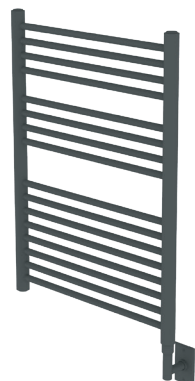

Matte Black (MB)

DENVER

HOUSTON

LAS VEGAS

SEATTLE

TUCSON

TUS-0920600-PC

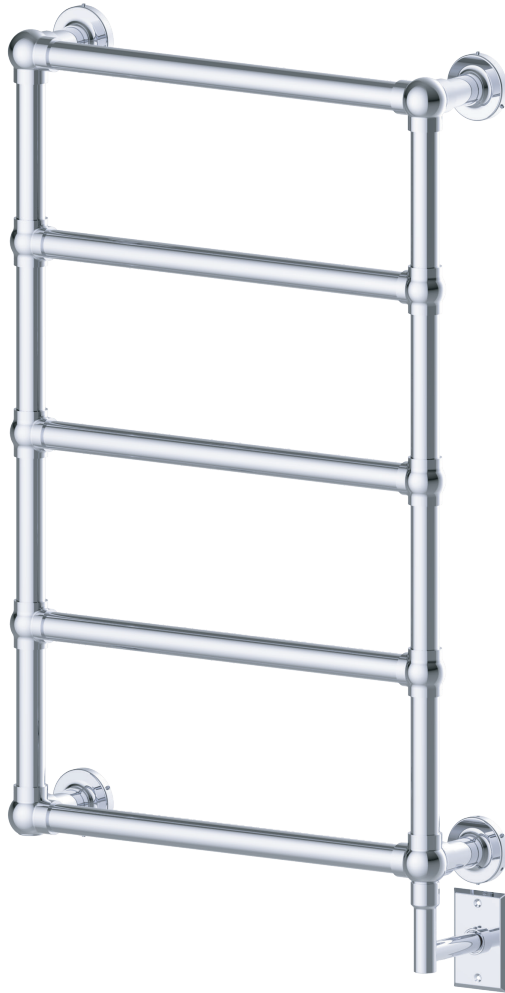

FEATURES

- WALL MOUNTED
 - HARDWIRE INSTALLATION KIT
 - MOUNTING INSTRUCTIONS
 - ALL ELECTRIC AND OIL FILLED
 - COVER PLATES
- TIMERS AVAILABLE SEPARATELY (NOT INCLUDED)

FINISHES IN STOCK

- POLISHED CHROME (PC)
- BRUSHED NICKEL (BN)
- POLISHED NICKEL (PN)

SIZES

- 920 x 600 MM

WARRANTY

10 Year Body Warranty
5 Year Electrical Warranty

Corps de 10 ans
Garante électrique de 5 ans

Cuerpo de 10 años
5 años de garantía eléctrica

TIMERS AVAILABLE



VPT24-1PZ



DDS15-BDZ

* See page 28 for Timer Pricing

Product Code	Finishes	Sizes (mm)		Sizes (Inches)		Output (Watts/BTU)	Element Size	Number of Elements
		Height	Width	Height	Width			
TUS-0920600	PC, BN, PN	920	600	36.62	23.62	208 / 709	300W	5

TUCSON SERIES

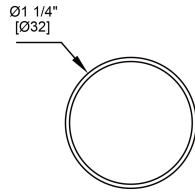
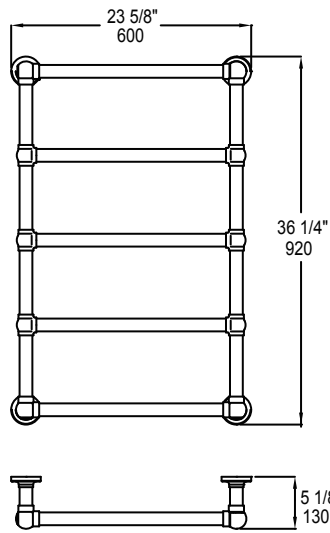

HORIZONTAL TUBE

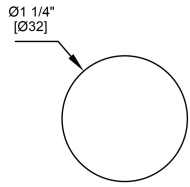

VERTICAL TUBE

PRODUCT	NAME	FINISH	PRICE
TUS-0920600-PC	Towel Warmer	Polished Chrome	\$880
TUS-0920600-BN	Towel Warmer	Brushed Nickel	\$1300
TUS-0920600-PN	Towel Warmer	Polished Nickel	\$1300

AVAILABLE FINISHES

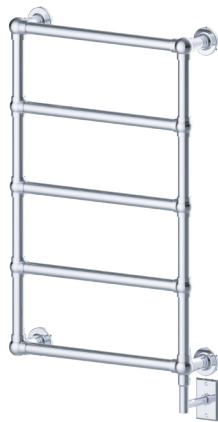

Polished Chrome (PC)

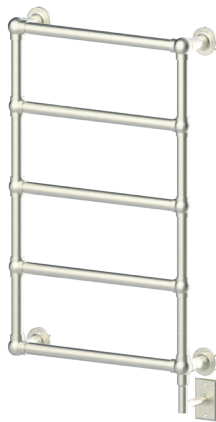

Brushed Nickel (BN)



Polished Nickel (PN)

	PRODUCT	NAME	FINISH	PRICE
	VPT24-1PZ	Timer	White	\$45
				NET PRICE PLEASE NOTE

LEVITON TIMERS

24/7 TIMER

Vizia+ 24 hour Timer 120VAC, 60HZ, 1800W Incandescent, 15A Resistive/Inductive, 1HP, for single pole, 3-way or more locations, with astronomic clock, backlit LCD display, timer settings at a glance, green LED locator, neutral required. White assembled on device, ivory and light almond included.



DDS15-BDZ	Timer	White	\$35
-----------	-------	-------	------

**NET PRICE
PLEASE NOTE**

LEVITON TIMERS

24/7 BLUETOOTH TIMER

Decora Digital Switch and 24 hour Timer 1800W Incandescent (120V), 15A Fluorescent (120V), 6A Fluorescent (277V), 5A 600W LED/CFL (120V), 15A Resistive (120V), 1/2 HP Motor (120V), Single Pole and 3-way/multi-location control with LED locator. White face assembled on device, Ivory and Light Almond faces included. Neutral wire required.

ATLANTA	6	BOSTON	12	DEN-0800600-MB	19	SEA-0800600-BN	25
ATL-0800600-PC	7	BOS-0800500-PC	13	DEN-1200600-PC	19	SEA-0800600-PN	25
ATL-0800600-BN	7	BOS-0800500-BN	13	DEN-1200600-BN	19	SEA-0800600-MB	25
ATL-0800600-PN	7	BOS-0800500-PN	13	DEN-1200600-PN	19	SEA-1200600-PC	25
ATL-0800600-MB	7	BOS-0800500-MB	13	DEN-1200600-MB	19	SEA-1200600-BN	25
ATL-1200600-PC	7	BOS-1200600-PC	13			SEA-1200600-PN	25
ATL-1200600-BN	7	BOS-1200600-BN	13	HOUSTON	20	SEA-1200600-MB	25
ATL-1200600-PN	7			HOU-0800600-PC	21		
ATL-1200600-MB	7	CHICAGO	14	HOU-0800600-BN	21	TUCSON	26
		ORD-0800500-PC	15	HOU-0800600-PN	21	TUS-0920600-PC	27
		ORD-0800500-PN	15	HOU-0800600-MB	21	TUS-0920600-BN	27
ATLANTIC CITY	8	ORD-0800500-MB	15	HOU-1200600-PC	21	TUS-0920600-PN	27
ACY-0800600-PC	9	ORD-1200600-PC	15	HOU-1200600-BN	21		
ACY-0800600-BN	9	ORD-1200600-PN	15	HOU-1200600-PN	21	TIMERS	28
ACY-0800600-PN	9	ORD-1200600-MB	15	HOU-1200600-MB	21	VPT24-1PZ	28
ACY-0800600-MB	9					DDS15-BDZ	28
ACY-1200600-PC	9						
ACY-1200600-BN	9	DALLAS	16	LAS VEGAS	22		
ACY-1200600-PN	9	DAL-0800600-PC	17	LAS-0800600-PC	23		
ACY-1200600-MB	9	DAL-0800600-BN	17	LAS-0800600-BN	23		
		DAL-0800600-MB	17	LAS-0800600-PN	23		
		DAL-1200600-PC	17	LAS-0800600-MB	23		
AUGUSTA	10	DAL-1200600-BN	17	LAS-1200600-PC	23		
AGS-0800500-PC	11	DAL-1200600-MB	17	LAS-1200600-BN	23		
AGS-0800500-PN	11			LAS-1200600-PN	23		
AGS-0800500-MB	11	DENVER	18	LAS-1200600-MB	23		
AGS-1200500-PC	11	DEN-0800600-PC	19				
AGS-1200500-PN	11	DEN-0800600-BN	19	SEATTLE	24		
AGS-1200500-MB	11	DEN-0800600-PN	19	SEA-0800600-PC	25		



CARE & WARRANTY

Vernon Towel Warmers Inc.: Care instructions and 10 year body, 5 year electrical warranty Information

Thank you for purchasing your Vernon Towel Warmers. Each of our products are manufactured with advanced technology, assuring durability, high quality and the best design.

Care Instructions

To care for your new Vernon Towel Warmers, clean regularly with a soft, damp cloth or sponge. Do not use rough or abrasive cleaning products that may compromise your warranty. Over time, some finishes will gently age in appearance under normal use. These finish changes are not considered a manufacturing defect and is excluded under warranty.

10 year body, 5 year electrical warranty

We are pleased to offer a **10 YEAR BODY, 5 YEAR ELECTRICAL WARRANTY*** – you are eligible if the product fails due to defects in materials or workmanship. Vernon Towel Warmers have been manufactured under the highest standards of quality and workmanship. Vernon Towel Warmers Inc. warrant these products to be free from defects in material and workmanship. Proof of purchase (original sales receipt) from the original customer must accompany all warranty claims. Vernon Towel Warmers will advise you of the procedure to follow in making warranty claims. Simply contact Vernon Towel Warmers, explain the defect and supply proof of purchase along with your name, address, area code and telephone number. Vernon Towel Warmers Inc. decision is absolutely final and without informal arbitration. Each product shipped will have a limited lifetime warranty enclosed with the below limitations, the below exclusions and the warranty period covered. The sole and exclusive remedy for any defect in material or workmanship under the Warranty is that a new part or product shall be mailed free of charge, and postage prepaid to the party under the Warranty. Vernon Towel Warmers is not responsible for any labour charges, injuries or any other loss or damages whatsoever. Defects or damage caused by the use of other than genuine parts are not covered by the Warranty. The Warranty is not valid unless all amounts payable by the buyer to Vernon Towel Warmers Inc., have been paid in full (including any extras, service calls or other amounts due). Vernon Towel Warmers Inc. , does not assume any liability for any work performed by third parties. There is no warranty or implied warranty other than specified above.

FREIGHT TERMS:

Freight allowed and prepaid to all points in North America on any order over \$1,500 or more net invoice value.

CLAIMS:

Any claim for errors or shortages for which Vernon Towel Warmers Inc. is responsible must be reported within 10 days after receipt of merchandise. Claims for damaged or lost shipments must be made to the carrier.

RETURNED GOODS/CANCELLATION:

No merchandise may be returned without written consent from Vernon Towel Warmers Inc. The RGA "Returned Goods Authorization Number" must be shown on all labels and a copy of the RGA form should be included. A 25% re-stocking charge may be applicable.

Orders for modified, special order, project order or custom products, as well as those not listed in current list books, may not be cancelled or returned. Orders for all other product in current list price books may be cancelled prior to the shipment leaving Vernon Towel Warmers Inc. Special Order Finishes (finishes other than those stocked by Vernon Towel Warmers Inc., per stocking chart) may be cancelled in 24 hours of order but may not be cancelled or returned after 24 hours of order being placed.

Vernon Towel Warmers Inc. reserves the right to give partial or no credit for the following reasons: Improperly returned merchandise, used product with no resale value as deemed by Vernon Towel Warmers Inc., merchandise has been returned after fourteen (14) days of RGA approval, merchandise did not originate from Vernon Towel Warmers Inc., or the product returned does not match the reasons for return stated on the initial RGA request.

to the original consumer during the life of the product. The product must be in the original installation site from the date of purchase to be considered. The original sales receipt must be provided to Vernon Towel Warmers Inc. for all warranty claims.

The warranty excludes products that have been accidentally damaged, altered, misused, normal wear and tear or damaged through use of abrasive cleaning agents. This warranty does not cover shipping costs for replacement parts, service or labour costs to replace this product. This is Vernon Towel Warmers Inc. exclusive written warranty. **Enjoy your Vernon Towel Warmers!**

To obtain warranty service contact:

Local Dealer: See dealer locator at vernontowelwarmers.com
Call Toll Free: 1-877-490-3537

Vernon Towel Warmers Inc.

1146 15th Street West - North Vancouver, BC V7P 1M9

Email us at support@vernontowelwarmers.com



WWW.VERNONTOWELWARMERS.COM

1-877-490-3537 (TOLL FREE)

Vernon Towel Warmers Inc.

VTW-27-10-2020-US