

OMNIA

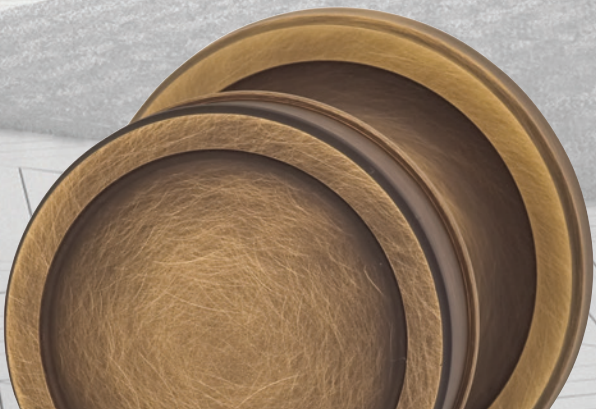

ARC



SINCE
1964

BEADED

508BD50

WILL NOT FIT 2 1/8" BORE.

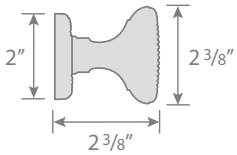

PA/PR \$244
SD \$120

508BD67

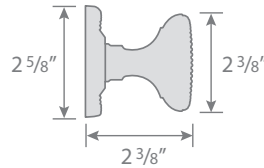

PA/PR \$244
SD \$120

MILLED

511ML50

WILL NOT FIT 2 1/8" BORE.

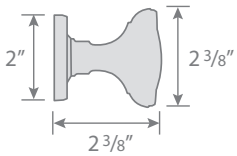

PA/PR \$244
SD \$120

511ML67

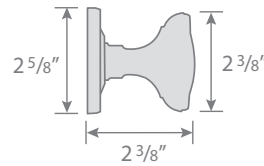

PA/PR \$244
SD \$120

EDGED

513ED50

WILL NOT FIT 2 1/8" BORE.

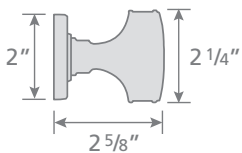

PA/PR \$244
SD \$120

513ED67

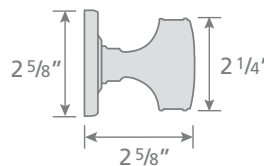

PA/PR \$244
SD \$120

PA/PR = Passage/Privacy • SD = Single Dummy

FINISHES: US3, US3A, US4, US5, US10B, US14, US15, US26

BEADED

748BD50

WILL NOT FIT 2 1/8" BORE.

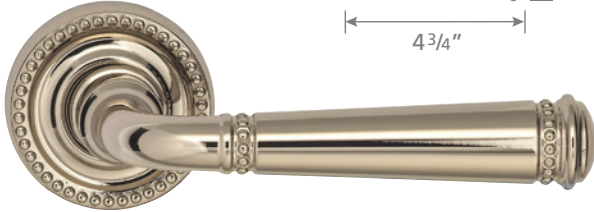
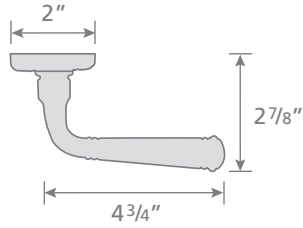

PA/PR \$244
SD \$120

748BD67

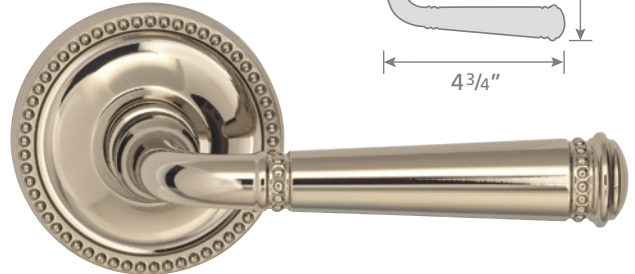
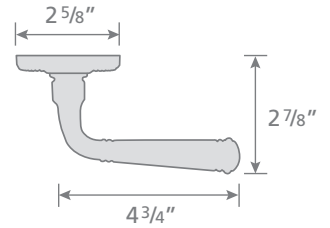

PA/PR \$244
SD \$120

MILLED

751ML50

WILL NOT FIT 2 1/8" BORE.

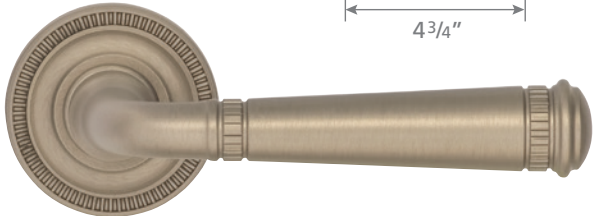
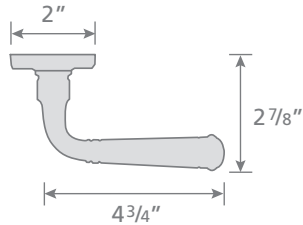

PA/PR \$244
SD \$120

751ML67

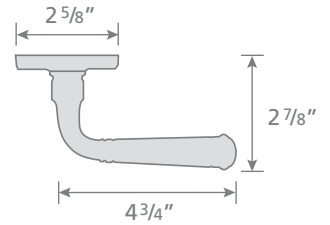

PA/PR \$244
SD \$120

EDGED

753ED50

WILL NOT FIT 2 1/8" BORE.

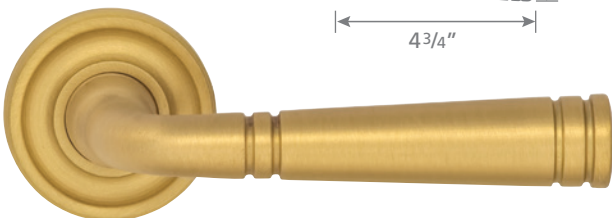
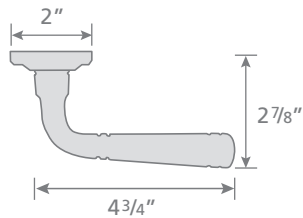

PA/PR \$244
SD \$120

753ED67

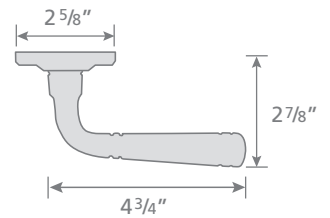

PA/PR \$244
SD \$120

OMNIA ARC

How to Order

EXAMPLE	Design	Rose Option	Rose Size	Latch	Strike	Function	Finish
	751	ED	50	238	F	PA	15
		BD = Beaded ED = Edged ML = Milled	50 = 50 mm 67 = 67 mm	238 = 2 3/8" Backset 234 = 2 3/4" Backset 0 = Single Dummy	T = "T" Strike F = Full Lip Strike	See Function Codes Below*	See Finish Codes Below**

Example product order number would be **751ED50/238F.PA15**

Product Data

Knob and Lever Latchset

- 2 3/8" (standard) and 2 3/4" backsets available.
- Supplied for 1 3/8" door thickness as standard. The minimum door thickness is 1 1/4"; the maximum door thickness is 2 1/2" (please specify).
- All lever latchsets meet ADA accessibility requirements.

Each set consists of solid brass knobs or levers, concealed screw finished roses, metal thru-bolting spring-assisted rose cassette, latch, strike, dust box, faceplate, spindle, all necessary mounting screws, installation template and instructions.



Latchsets with any of the smaller roses are available with a push-button privacy function just like the larger roses.

About Our Tubular Latch

- 28° rotation to retract latch.
- Tough, non-rusting materials used throughout. Face covers and strikes are solid brass. No.013 "T" strike supplied as standard or No.014 "Full Lip" strike as an option. (Please specify.)
- Critical interior parts are made of solid brass.
- For over five decades, OMNIA's latches have been opening and closing millions of doors all around the world.

Function Codes*

- **PA = Passage:** Latch operates by knob or lever from either side of door.
- **PR = Privacy:** Push pin provided for privacy inside room. Emergency release hole for outside room. Emergency release key also provided.
- **SD = Single Dummy:** Trim on one side of door only. Concealed screw roses for surface mounting. Knob or lever with rose.

FINISH CODES**



Latchset Component List

- A - Door Knob/Lever (2)
- B - Set Screw (2)
- C - Nylon Threaded Washer (2)
- D - Finished Rose (2)
- Ea - Metal Spring Assist Sub-Rose
- Eb - Metal Spring Assist Sub-Rose
- F - Spindle (Teardrop groove positioned towards set screw)
- G - Tubular Latch
- H - Privacy Locking Block Machine Screw
- I - Privacy Locking Block Locking Stopper
- J - Privacy Locking Block
- K - Tubular Latch Faceplate
- L - Tubular Latch Strike Plate
- M - Tubular Latch Dust Box
- N - Thru-Bolt Machine Screws With Locking Washer (2)
- O - Washer Installation Tool
- P - Privacy Locking Pin (For Privacy ONLY)
- Q - Emergency Release Key

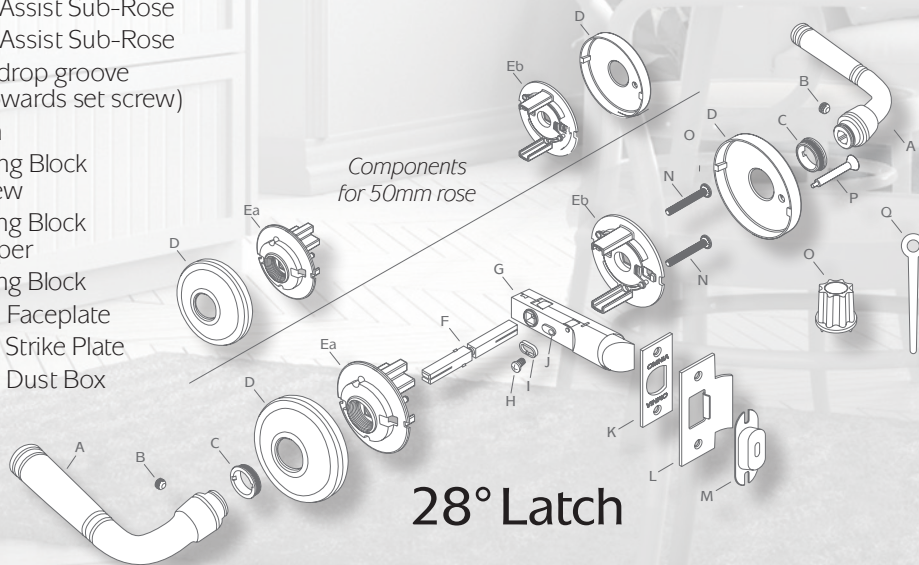

28° Latch

SMALL ROSES WILL NOT FIT 2 1/8" BORE.

ALL ROSES ARE CONCEALED SCREW MOUNTED.