



2020 CABINET & ARCHITECTURAL HARDWARE

OMNIA

MANUFACTURERS OF FINE LOCKSETS & ARCHITECTURAL HARDWARE

Table of Contents

SECTION	PAGE
Finishes Chart	3
CABINET/APPLIANCE PULLS & KNOBS • SOLID BRASS & GLASS	
Elite	4-5
Ultima III	6-8
Ultima Knobs	9
Ultima II	10-12
Ultima I	13-15
Traditions	16-17
Prodigy	17
CABINET/APPLIANCE PULLS & KNOBS • STAINLESS STEEL	
Cabinet Pulls	18-20
Cabinet Knobs	21
CABINET KNOBS & PULLS • SOLID BRASS	
Legacy	22
Ornate	23
ALL DOOR PULLS/APPLIANCE PULLS	
Stainless Steel	24
Elite	24
Traditions	25
Ultima I	25
Ultima II	26
Ultima III	27
MISC. ARCHITECTURAL HARDWARE	
Flushcups • Solid Brass & Stainless Steel	28-29
Door Stops & Ball Catch • Solid Brass & Stainless Steel	30
Latch & Decorative Hooks • Solid Brass	31
Switchplates • Solid Brass	32-34
OMNIA TERMS & CONDITIONS	35

The story of OMNIA began over fifty-five years ago when our company's founder, Alberto R. Comini came to this country with a vision to introduce to the U.S. market beautifully designed and crafted Italian architectural hardware. To this day, OMNIA has steadfast ties to Italy and while now helmed by the next generation of Comini family members, we continue to stay true to our founding principle of forging our own path.

It is all the people behind the products that make up the OMNIA family including our fiercely loyal employees and our customers with whom we have fostered long-standing relationships. As our business grows, so does our family tree and new opportunities are greeted with Italian hospitality and warmth.

Over the course of our history, OMNIA has built a legacy upon developing products innovative in both design and technological advancement. Our focus is always on what lies ahead and we constantly challenge ourselves to stay in the forefront of our industry. This latest presentation showcases our current product offerings shown with suggested retail prices.

Our products are meticulously fabricated from the finest brass materials or premium-grade stainless steel in order to meet the exceptional standards of the finished project of your dreams. Choose the hardware that is expressly YOU and come to know the look and feel of OMNIA.

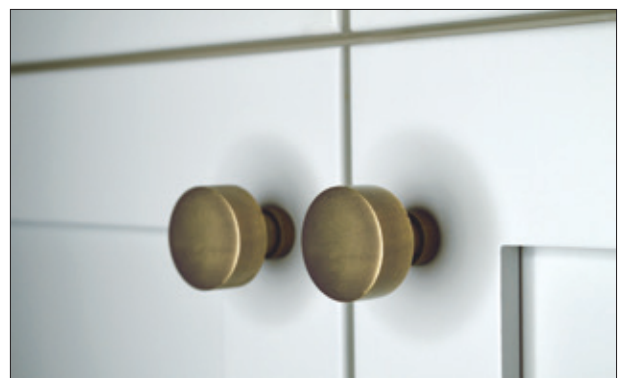

OMNIA Finishes

Always check each item number to make sure a finish is available for a particular design.

	Code	Description		Code	Description
	US3	POLISHED BRASS, LACQUERED		US14	POLISHED, NICKEL PLATED, LACQUERED
	US3A	POLISHED BRASS, UNLACQUERED		US15	SATIN, NICKEL PLATED, LAQUERED
	US4	SATIN BRASS, LACQUERED		US26	POLISHED CHROME PLATED
	US5	ANTIQUE BRASS, LACQUERED		US32D	SATIN STAINLESS STEEL
	US10B	BLACK, OIL-RUBBED, LAQUERED			

Additional Finishes

(Only available on certain items)



US15A
PEWTER,
LACQUERED



SB
SHADED BRONZE,
LACQUERED



VC
VINTAGE COPPER



US26D
SATIN CHROME
PLATED



VB
VINTAGE BRASS



VI
VINTAGE IRON

ELITE

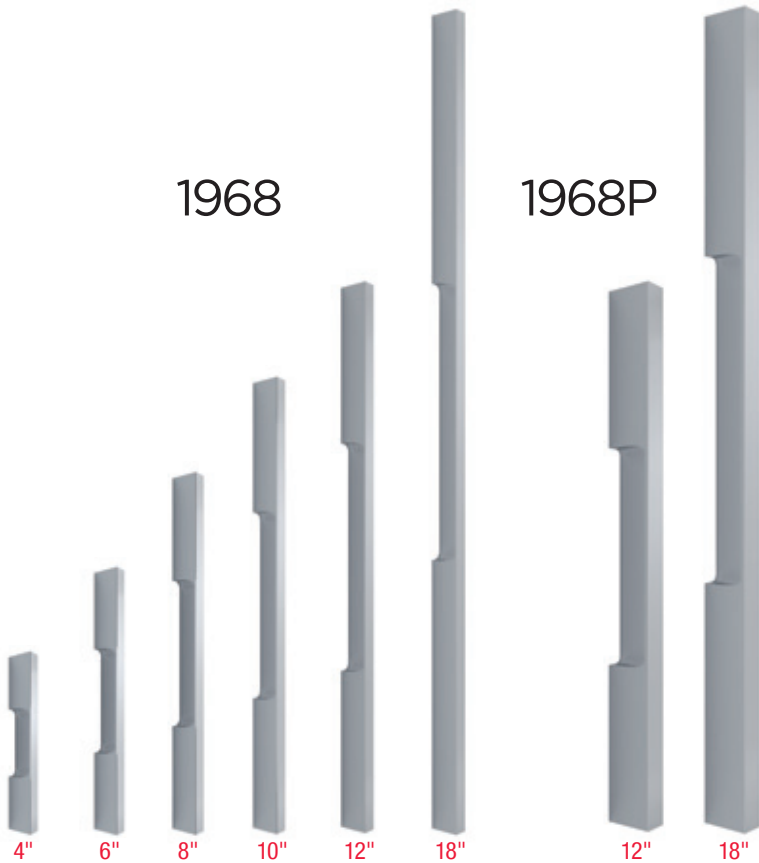

Item#	Center to Center	Overall Length	Proj.	FINISHES		
				US4 US14 US26	US5 US10B US15	
1968 Cabinet Pull 5/16" W	1968/102	4"	4 1/2"	1 1/16"	\$34	\$38
	1968/153	6"	6 1/2"		38	44
	1968/203	8"	8 1/2"		46	51
	1968/254	10"	10 1/2"		49	57
	1968/305	12"	12 1/2"		59	67
1968/457	18"	18 1/2"		69	78	
1968P Appliance Pull 1 9/32" W	1968P/305	12"	12 15/16"	1 3/16"	\$175	\$185
	1968P/305B*	12"	12 15/16"		175	185
	1968P/457	18"	18 15/16"		225	235
	1968P/457B*	18"	18 15/16"		225	235

*In order to achieve back-to-back, order one regular pull and one B.

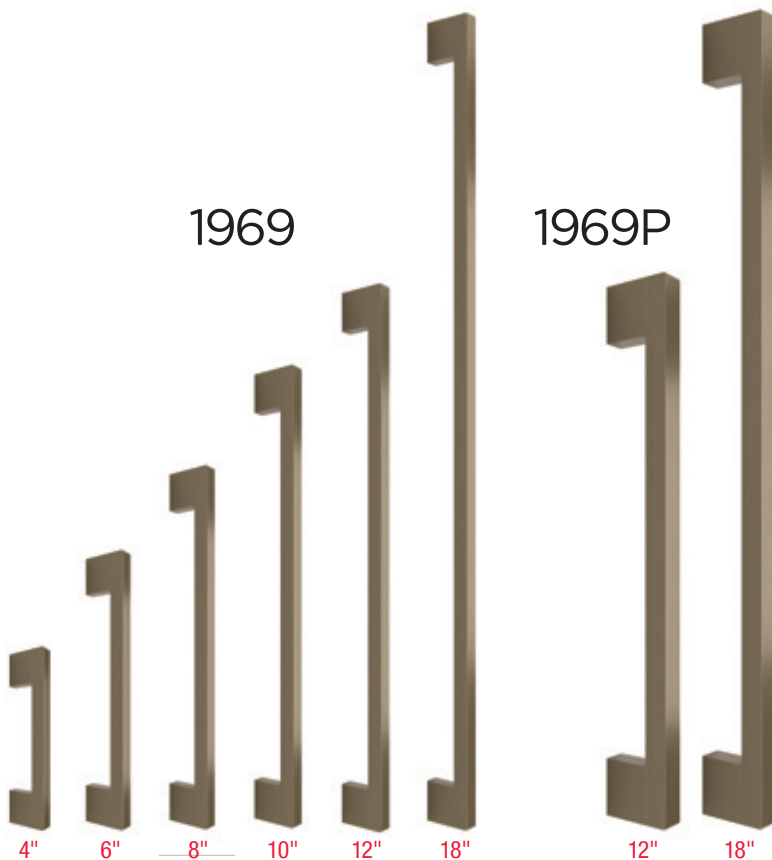

Item#	Center to Center	Overall Length	Proj.	FINISHES		
				US4 US14 US26	US5 US10B US15	
1969 Cabinet Pull 5/16" W	1969/102	4"	4 15/16"	1 3/16"	\$42	\$46
	1969/153	6"	6 15/16"		51	56
	1969/203	8"	8 15/16"		59	69
	1969/254	10"	10 15/16"		68	74
	1969/305	12"	12 15/16"		77	86
1969/457	18"	18 15/16"		103	110	
1969P Appliance Pull 1 9/32" W	1969P/305	12"	13 1/8"	1 3/4"	\$190	\$198
	1969P/305B*	12"	13 1/8"		190	198
	1969P/457	18"	19 1/8"		235	240
	1969P/457B*	18"	19 1/8"		235	240

*In order to achieve back-to-back, order one regular pull and one B.

Suggested retail prices effective August 1, 2020.

ELITE

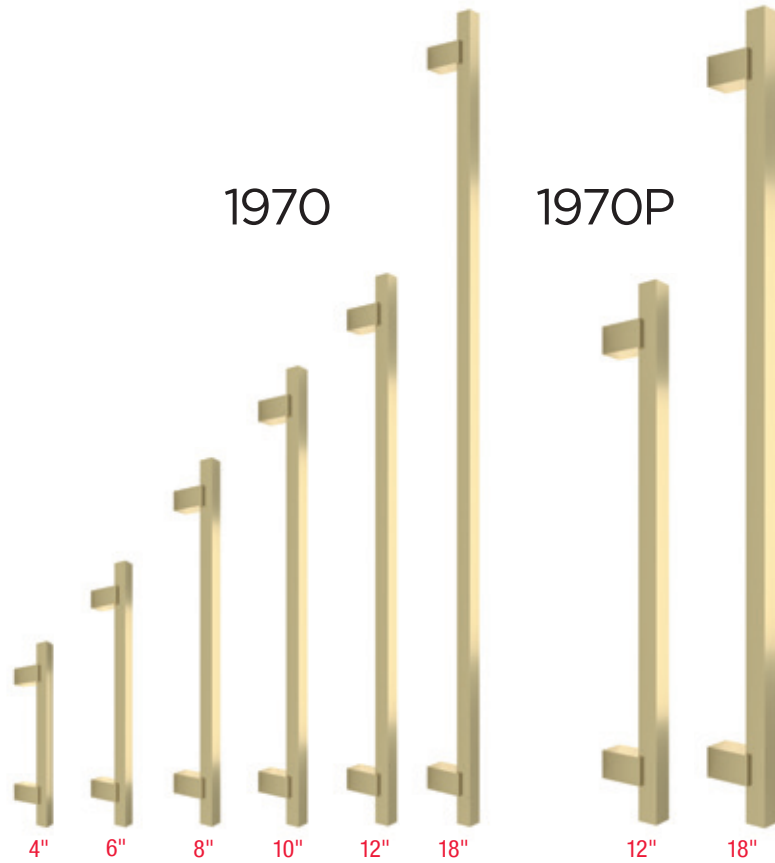

Item#	Center to Center	Overall Length	Proj.	FINISHES		
				US4 US14 US26	US5 US10B US15	US10B US15
1970 Cabinet Pull 9/16" W	1970/102	4"	5 ¹⁵ / ₁₆ "	1 ¹ / ₄ "	\$61	\$67
	1970/153	6"	7 ¹⁵ / ₁₆ "		65	75
	1970/203	8"	9 ¹⁵ / ₁₆ "		69	82
	1970/254	10"	11 ¹⁵ / ₁₆ "		72	87
	1970/305	12"	13 ¹⁵ / ₁₆ "		77	94
	1970/457	18"	19 ¹⁵ / ₁₆ "		85	98
1970P Appliance Pull 1 ³ / ₁₆ " W	1970P/305	12"	14 ³ / ₄ "	1 ³ / ₄ "	\$190	\$198
	1970P/305B*	12"	14 ³ / ₄ "		190	198
	1970P/457	18"	20 ³ / ₄ "		235	240
	1970P/457B*	18"	20 ³ / ₄ "		235	240

*In order to achieve back-to-back, order one regular pull and one B.

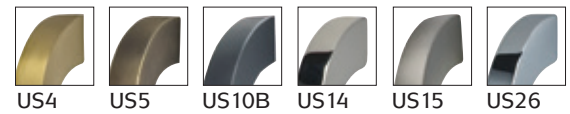
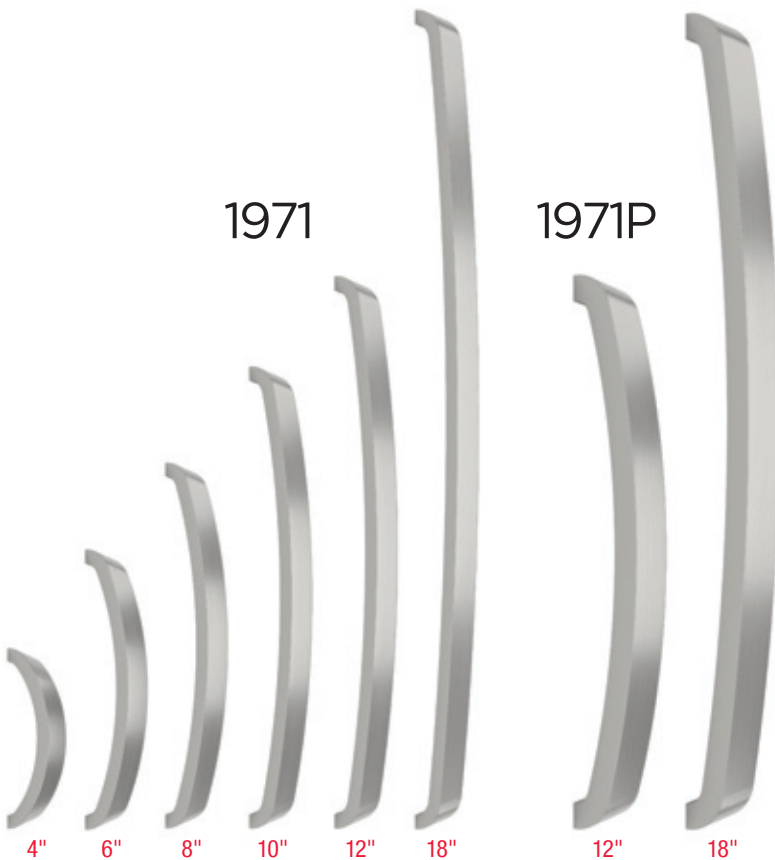

Item#	Center to Center	Overall Length	Proj.	FINISHES		
				US4 US14 US26	US5 US10B US15	US10B US15
1971 Cabinet Pull 3/4" W	1971/102	4"	4 ³ / ₈ "	1 ³ / ₁₆ "	\$34	\$38
	1971/153	6"	6 ³ / ₈ "		38	44
	1971/203	8"	8 ³ / ₈ "		46	51
	1971/254	10"	10 ³ / ₈ "		49	57
	1971/305	12"	12 ³ / ₈ "		59	67
	1971/457	18"	18 ³ / ₈ "		69	78
1971P Appliance Pull 1 ³ / ₁₆ " W	1971P/305	12"	12 ¹¹ / ₁₆ "	1 ³ / ₄ "	\$175	\$185
	1971P/305B*	12"	12 ¹¹ / ₁₆ "		175	185
	1971P/457	18"	18 ⁹ / ₁₆ "		225	235
	1971P/457B*	18"	18 ⁹ / ₁₆ "		225	235

*In order to achieve back-to-back, order one regular pull and one B.

Suggested retail prices effective August 1, 2020.

Ultima III



Item#	Center to Center	Overall Length	Proj.	FINISHES					
				US3A	US4	US5	US10B	US14	US15
9029 Cabinet Pull 7/16" W	9029/102	4"	4 7/16"	1 3/16"	\$23				
	9029/153	6"	6 7/16"		32				
	9029/203	8"	8 7/16"		42				
	9029/254	10"	10 7/16"		51				
	9029/305	12"	12 7/16"		61				
	9029/457	18"	18 7/16"		89				
9029P Appliance Pull 3/4" W	9029P/305	12"	12 3/4"	2 3/16"	\$201				
	9029P/305B*	12"	12 3/4"		201				
	9029P/457	18"	18 3/4"		298				
	9029P/457B*	18"	18 3/4"		298				

*In order to achieve back-to-back, order one regular pull and one B.



Item#	Center to Center	Overall Length	Proj.	FINISHES					
				US3A	US4	US5	US10B	US14	US15
9031 Cabinet Pull 7/16" W	9031/102	4"	4 7/16"	1 3/16"	\$29				
	9031/153	6"	6 7/16"		39				
	9031/203	8"	8 7/16"		48				
	9031/254	10"	10 7/16"		57				
	9031/305	12"	12 7/16"		67				
	9031/457	18"	18 7/16"		95				
9031P Appliance Pull 3/4" W	9031P/305	12"	12 3/4"	2 3/16"	\$215				
	9031P/305B*	12"	12 3/4"		215				
	9031P/457	18"	18 3/4"		320				
	9031P/457B*	18"	18 3/4"		320				

*In order to achieve back-to-back, order one regular pull and one B.

Suggested retail prices effective August 1, 2020.

Ultima III



	Item#	Center to Center	Overall Length	Proj.	FINISHES						
					US3A	US4	US5	US10B	US14	US15	US26
9037 Cabinet Pull	9037/102	4"	4 ⁷ / ₁₆ "	1 ¹ / ₈ "						\$23	
	9037/153	6"	6 ⁷ / ₁₆ "							32	
	9037/203	8"	8 ⁷ / ₁₆ "							42	
	7 ¹ / ₁₆ " max. dia.	9037/254	10"	10 ⁷ / ₁₆ "							51
		9037/305	12"	12 ⁷ / ₁₆ "							61
		9037/457	18"	18 ⁷ / ₁₆ "							89
9037P Appliance Pull	9037P/305	12"	12 ³ / ₄ "	2 ¹ / ₈ "						\$201	
	9037P/305B*	12"	12 ³ / ₄ "							201	
	9037P/457	18"	18 ³ / ₄ "							298	
	3 ¹ / ₄ " max. dia.	9037P/457B*	18"	18 ³ / ₄ "							298

*In order to achieve back-to-back, order one regular pull and one B.

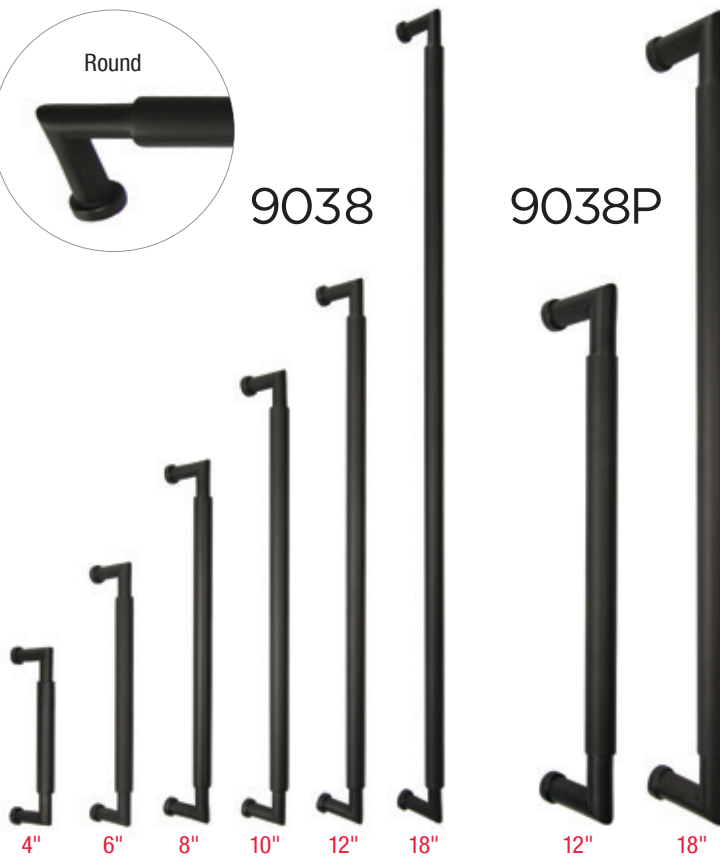

	Item#	Center to Center	Overall Length	Proj.	FINISHES						
					US3A	US4	US5	US10B	US14	US15	US26
9038 Cabinet Pull	9038/102	4"	4 ⁷ / ₁₆ "	1 ¹ / ₈ "						\$23	
	9038/153	6"	6 ⁷ / ₁₆ "							32	
	9038/203	8"	8 ⁷ / ₁₆ "							42	
	7 ¹ / ₁₆ " max. dia.	9038/254	10"	10 ⁷ / ₁₆ "							51
		9038/305	12"	12 ⁷ / ₁₆ "							61
		9038/457	18"	18 ⁷ / ₁₆ "							89
9038P Appliance Pull	9038P/305	12"	12 ³ / ₄ "	2 ¹ / ₈ "						\$201	
	9038P/305B*	12"	12 ³ / ₄ "							201	
	9038P/457	18"	18 ³ / ₄ "							298	
	3 ¹ / ₄ " max. dia.	9038P/457B*	18"	18 ³ / ₄ "							298

*In order to achieve back-to-back, order one regular pull and one B.

Suggested retail prices effective August 1, 2020.

Ultima III



Item#	Center to Center	Overall Length	Proj.	FINISHES				
				US3A	US4	US5	US10B US14 US15 US26	
9039 Cabinet Pull 1/2" W	9039/102	4"	4 7/16"	1 1/8"	\$23			
	9039/153	6"	6 7/16"		32			
	9039/203	8"	8 7/16"		42			
	9039/254	10"	10 7/16"		51			
	9039/305	12"	12 7/16"		61			
9039/457	18"	18 7/16"	89					
9039P Appliance Pull 13/16" W	9039P/305	12"	12 3/4"	2 1/8"	\$201			
	9039P/305B*	12"	12 3/4"		201			
	9039P/457	18"	18 3/4"		298			
	9039P/457B*	18"	18 3/4"		298			

*In order to achieve back-to-back, order one regular pull and one B.

Suggested retail prices effective August 1, 2020.

Ultima Knobs

9004

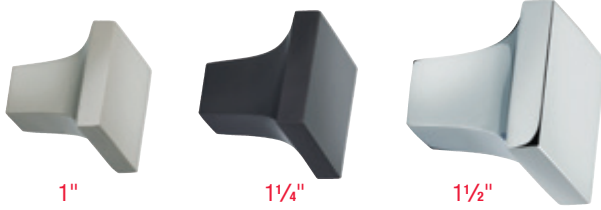

Item#	Width	Proj.	FINISHES				
			US3A US10B US15	US4 US14	US5 US26		
9004 Knob	9004/25	1" sq.	1"	\$13			
	9004/32	1 1/4" sq.	1 1/4"	19			
	9004/40	1 1/2" sq.	1 1/2"	29			

9035

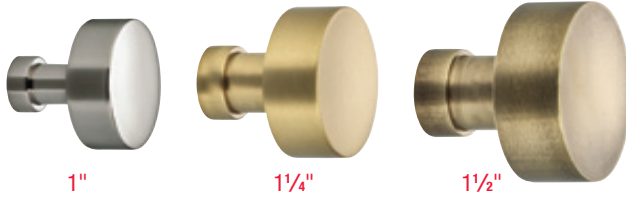

Item#	Dia.	Proj.	FINISHES				
			US3A US10B US15	US4 US14	US5 US26		
9035 Knob	9035/25	1"	1"	\$13			
	9035/32	1 1/4"	1 1/4"	19			
	9035/38	1 1/2"	1 1/2"	29			

9036



Item#	Dia.	Proj.	FINISHES				
			US3A US10B US15	US4 US14	US5 US26		
9036 Knob	9036/25	1"	1 5/16"	\$13			
	9036/32	1 1/4"	1 1/8"	19			
	9036/38	1 1/2"	1 1/2"	29			

9164



Item#	Width of Knob	Width of Rose	Proj.	FINISHES				
				US3A US10B US15	US4 US14	US5 US26		
9164 Knob	9164/25	1"	7/8"	1"	\$13			
	9164/32	1 1/4"	1"	1 1/4"	19			
	9164/38	1 1/2"	1 1/4"	1 3/8"	29			

9165

Rose is optional upon installation.



Item#	Dia. of Knob	Dia. of Rose	Proj.	FINISHES				
				US3 US26	US3A US14	US4 US15	US5 US26D	
9165 Knob	9165/25	1"	7/8"	1"	\$13			
	9165/30	1 1/4"	1"	1 1/4"	19			
	9165/35	1 1/2"	1 1/4"	1 3/8"	29			

9151

Rose is optional upon installation.

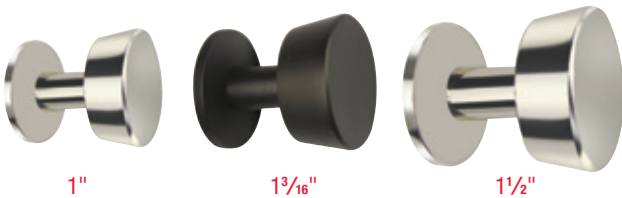

Item#	Dia. of Knob	Dia. of Rose	Proj.	FINISHES				
				US3 US10B US15	US3A US14	US4 US26	US5 US26D	
9151 Knob	9151/25	1"	7/8"	1"	\$10			
	9151/30	1 3/16"	1 1/16"	1 1/4"	14			
	9151/38	1 1/2"	1 1/4"	1 3/8"	20			

9153



Item#	Dia.	Proj.	FINISHES				
			US3 US26	US3A US14	US4 US15	US5 US26D	
9153 Knob	9153/18	3/4"	1 5/16"	\$10			
	9153/25	1"	1 1/4"	14			

Suggested retail prices effective August 1, 2020.

Ultima II

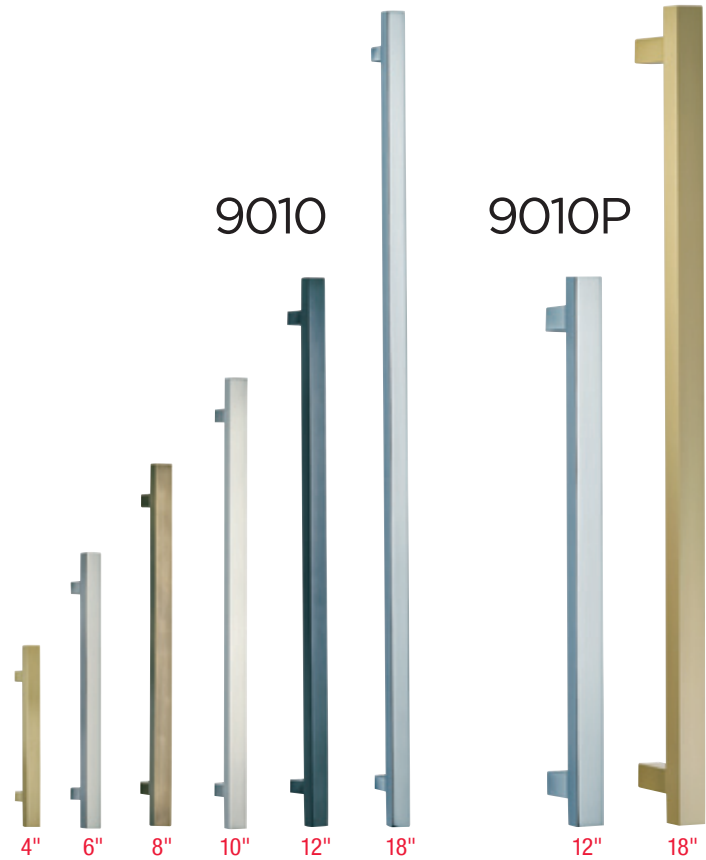

Item#	Center to Center	Overall Length	Proj.	FINISHES		
				US4 US14 US15 US26	US5 US10B	
9010 Cabinet Pull 1/2" w	9010/102	4"	6"	1 3/8"	\$29	\$34
	9010/153	6"	8"		37	43
	9010/203	8"	10"		46	53
	9010/254	10"	12"		54	62
	9010/305	12"	14"		62	72
9010/457	18"	20"		88	101	
9010P Appliance Pull 3/4" w	9010P/305	12"	14"	2 5/16"	\$152	\$175
	9010P/305B*	12"	14"		152	175
	9010P/457	18"	20"		214	246
	9010P/457B*	18"	20"		214	246

*In order to achieve back-to-back, order one regular pull and one B.



Item#	Center to Center	Overall Length	Proj.	FINISHES		
				US4 US14 US15 US26	US5 US10B	
9023 Cabinet Pull 5/16" w	9023/102	4"	4 1/2"	1 3/8"	\$15	\$17
	9023/153	6"	6 1/2"		20	23
	9023/203	8"	8 1/2"		25	29
	9023/254	10"	10 1/2"		32	36
	9023/305	12"	12 1/2"		36	42
9023/457	18"	18 1/2"		53	61	
9023P Appliance Pull 5/8" w	9023P/305	12"	12 3/4"	2 3/16"	\$148	\$170
	9023P/305B*	12"	12 3/4"		148	170
	9023P/457	18"	18 3/4"		205	236
	9023P/457B*	18"	18 3/4"		205	236

*In order to achieve back-to-back, order one regular pull and one B.

Suggested retail prices effective August 1, 2020.

Ultima II

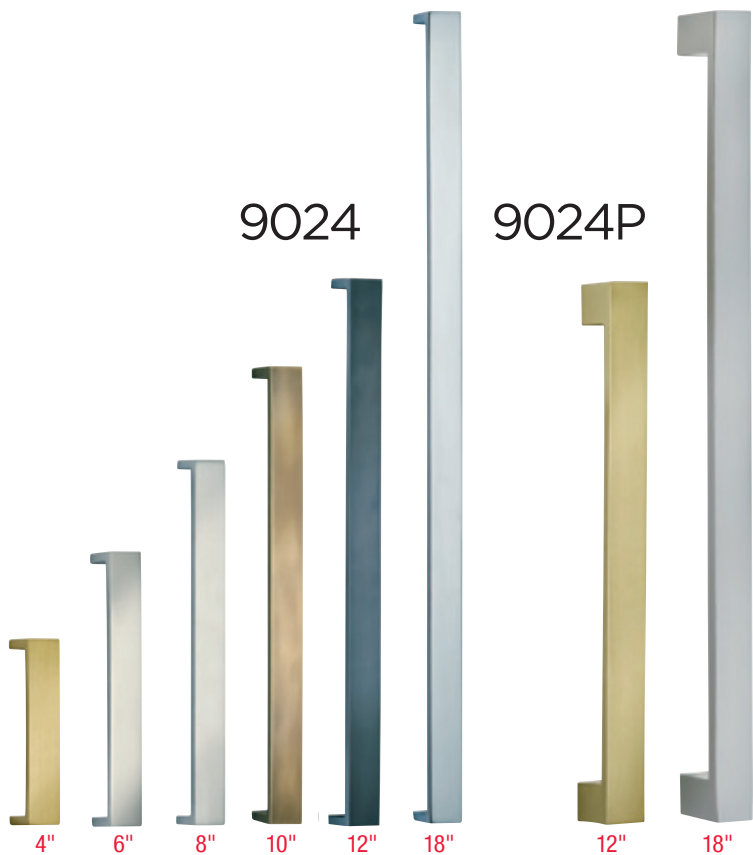

Item#	Center to Center	Overall Length	Proj.	FINISHES		
				US4 US14 US15 US26	US5 US10B	
9024 Cabinet Pull 3/4" w	9024/102	4"	4 1/4"	1 3/16"	\$20	\$23
	9024/153	6"	6 1/4"		26	30
	9024/203	8"	8 1/4"		33	37
	9024/254	10"	10 1/4"		39	45
	9024/305	12"	12 1/4"		45	52
9024/457	18"	18 1/4"	64	74		
9024P Appliance Pull 1" w	9024P/305	12"	13"	2"	\$132	\$152
	9024P/305B*	12"	13"		132	152
	9024P/457	18"	19"		178	204
	9024P/457B*	18"	19"		178	204

*In order to achieve back-to-back, order one regular pull and one B.

Bases are larger than cabinet pull bases to accommodate appliance mounting screws.

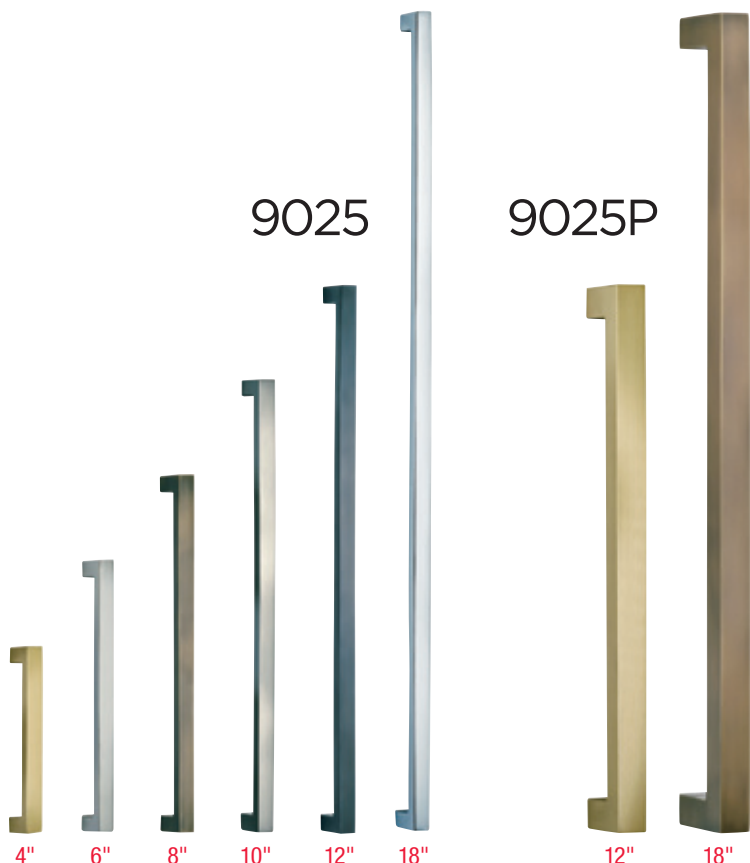

Item#	Center to Center	Overall Length	Proj.	FINISHES		
				US4 US14 US15 US26	US5 US10B	
9025 Cabinet Pull 5/8" w	9025/102	4"	4 7/16"	1 3/16"	\$17	\$19
	9025/153	6"	6 7/16"		23	26
	9025/203	8"	8 7/16"		28	32
	9025/254	10"	10 7/16"		34	39
	9025/305	12"	12 7/16"		40	46
9025/457	18"	18 7/16"	56	64		
9025P Appliance Pull 3/4" w	9025P/305	12"	12 3/4"	2"	\$151	\$174
	9025P/305B*	12"	12 3/4"		151	174
	9025P/457	18"	18 3/4"		212	244
	9025P/457B*	18"	18 3/4"		212	244

*In order to achieve back-to-back, order one regular pull and one B.

Suggested retail prices effective August 1, 2020.

Ultima II

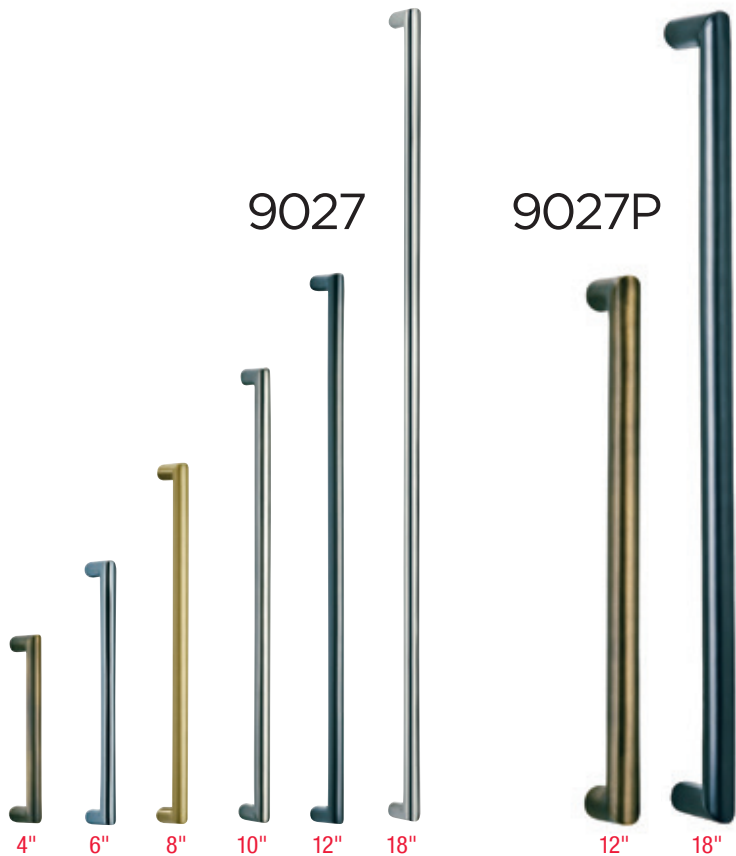

Item#	Center to Center	Overall Length	Proj.	FINISHES		
				US4 US14 US15 US26	US5 US10B	
9027 Cabinet Pull 3/8" w	9027/102	4"	4 7/16"	1 3/16"	\$12	\$14
	9027/153	6"	6 7/16"		16	19
	9027/203	8"	8 7/16"		20	23
	9027/254	10"	10 7/16"		25	29
	9027/305	12"	12 7/16"		29	34
9027/457	18"	18 7/16"		41	47	
9027P Appliance Pull 3/4" w	9027P/305	12"	12 3/4"	2"	\$120	\$138
	9027P/305B*	12"	12 3/4"		120	138
	9027P/457	18"	18 3/4"		167	193
	9027P/457B*	18"	18 3/4"		167	193

*In order to achieve back-to-back, order one regular pull and one B.

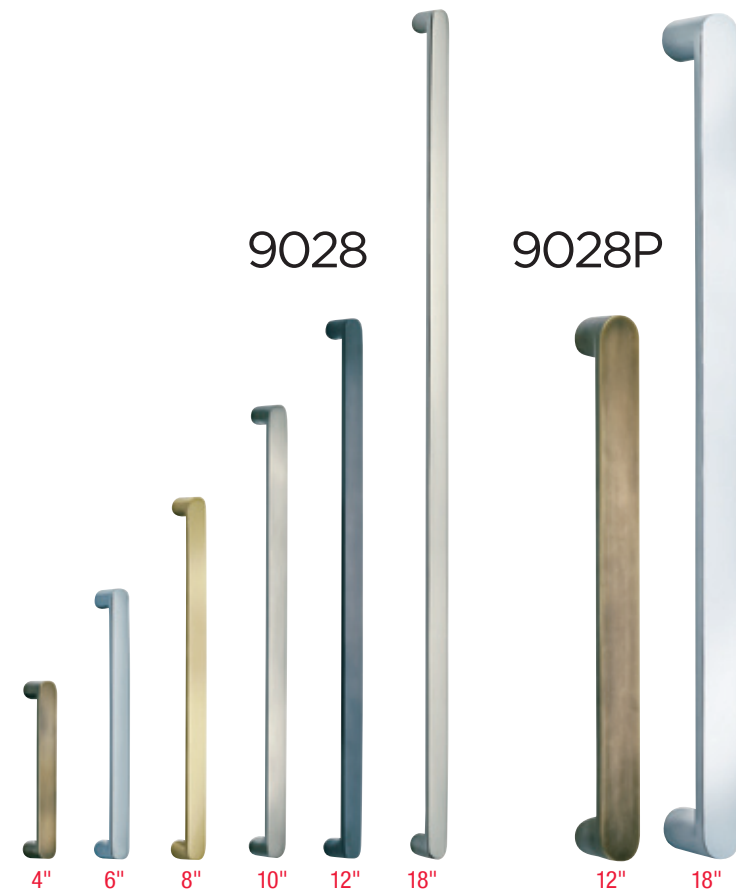

Item#	Center to Center	Overall Length	Proj.	FINISHES		
				US4 US14 US15 US26	US5 US10B	
9028 Cabinet Pull 7/16" w	9028/102	4"	4 1/2"	1 3/16"	\$14	\$16
	9028/153	6"	6 1/2"		17	20
	9028/203	8"	8 1/2"		21	24
	9028/254	10"	10 1/2"		25	28
	9028/305	12"	12 1/2"		28	33
9028/457	18"	18 1/2"		41	47	
9028P Appliance Pull 1" w	9028P/305	12"	13"	2"	\$126	\$145
	9028P/305B*	12"	13"		126	145
	9028P/457	18"	19"		167	193
	9028P/457B*	18"	19"		167	193

*In order to achieve back-to-back, order one regular pull and one B.

Suggested retail prices effective August 1, 2020.

Ultima I



Item#	Center to Center	Overall Length	Proj.	FINISHES		
				US15 US26	US10B US26	
9005 Cabinet Pull 5/8" W	9005/96	3 3/4"	4"	1 1/8"	\$13	\$13
	9005/146	5 3/4"	6"		18	18
	9005/197	7 3/4"	8"		24	25

Use 9006P below as a coordinating Appliance Pull.

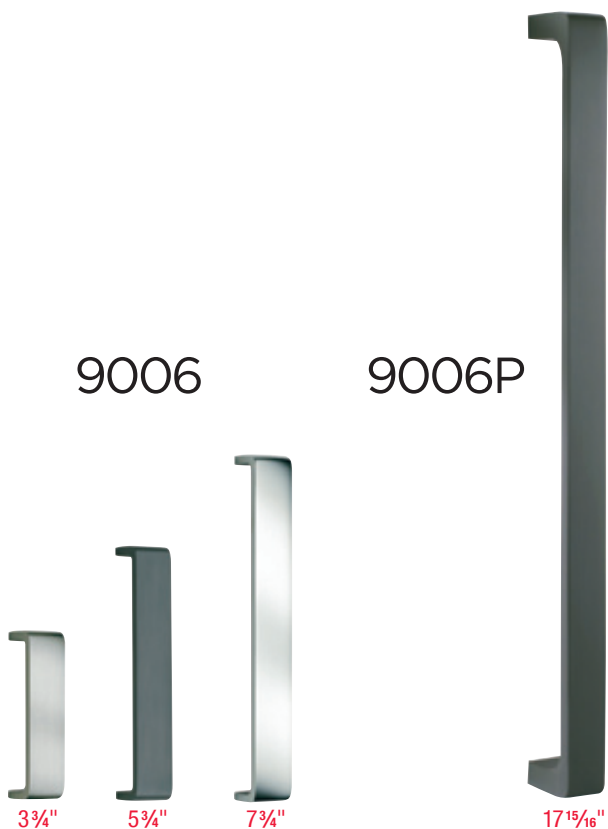

Item#	Center to Center	Overall Length	Proj.	FINISHES		
				US15 US26	US10B US26	
9006 Cabinet Pull 15/16" W	9006/96	3 3/4"	4"	1 1/8"	\$19	\$20
	9006/146	5 3/4"	6"		27	28
	9006/197	7 3/4"	8"		36	37

9006P Appliance Pull 1" W	9006P/440	17 5/16"	17 15/16"	2"	\$196	\$196
	9006P/440B*	17 5/16"	17 15/16"		196	196

*In order to achieve back-to-back, order one regular pull and one B.

Suggested retail prices effective August 1, 2020.

Ultima I

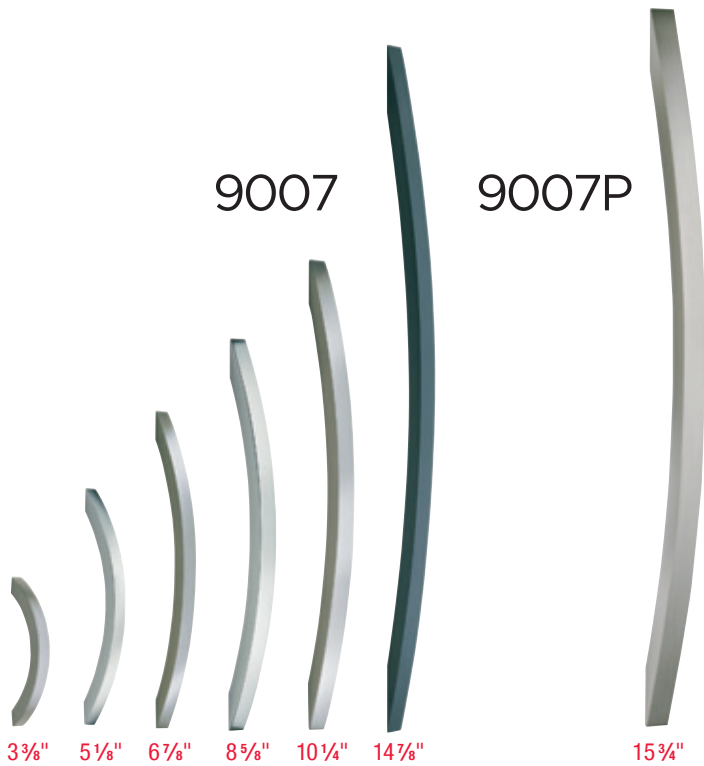

Item#	Center to Center	Overall Length	Proj.	FINISHES	
				US15 US26	US10B
9007 Cabinet Pull 3/8" W	9007/86	3 3/8"	4"	1 3/16"	\$11 \$12
	9007/130	5 1/8"	6"		15 16
	9007/175	6 7/8"	8"		20 20
1/2" W	9007/220	8 5/8"	10"	1 5/16"	\$40 \$42
	9007/260	10 1/4"	12"		48 50
	9007/377	14 7/8"	18"	1 3/8"	72 74
9007P Appliance Pull 5/8" W	9007P/400*	15 3/4"	17 15/16"	2"	\$146 \$146

*Not available back-to-back.

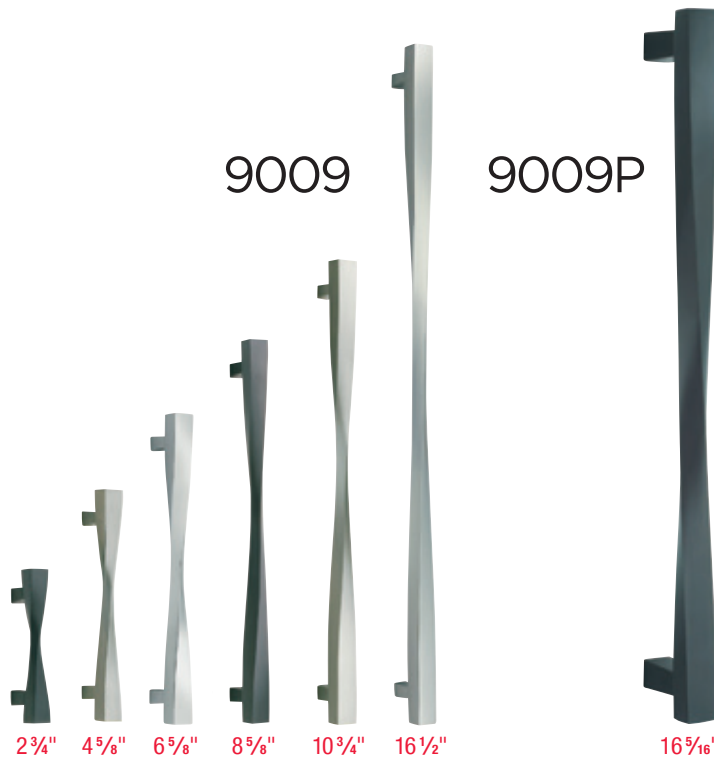

Item#	Center to Center	Overall Length	Proj.	FINISHES	
				US15 US26	US10B
9009 Cabinet Pull 9/16" W	9009/70	2 3/4"	4"	1 3/8"	\$18 \$18
	9009/118	4 5/8"	6"		25 26
	9009/170	6 5/8"	8"		35 36
	9009/220	8 5/8"	10"		40 41
	9009/273	10 3/4"	12 1/4"	1 1/2"	57 59
	9009/420	16 1/2"	18"		84 87
9009P Appliance Pull 7/8" W at widest point	9009P/415	16 5/16"	18"	2 5/8"	\$256 \$256
	9009P/415B*	16 5/16"	18"		256 256

*In order to achieve back-to-back, order one regular pull and one B.

Suggested retail prices effective August 1, 2020.

Ultima I

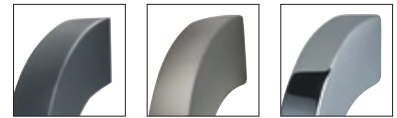
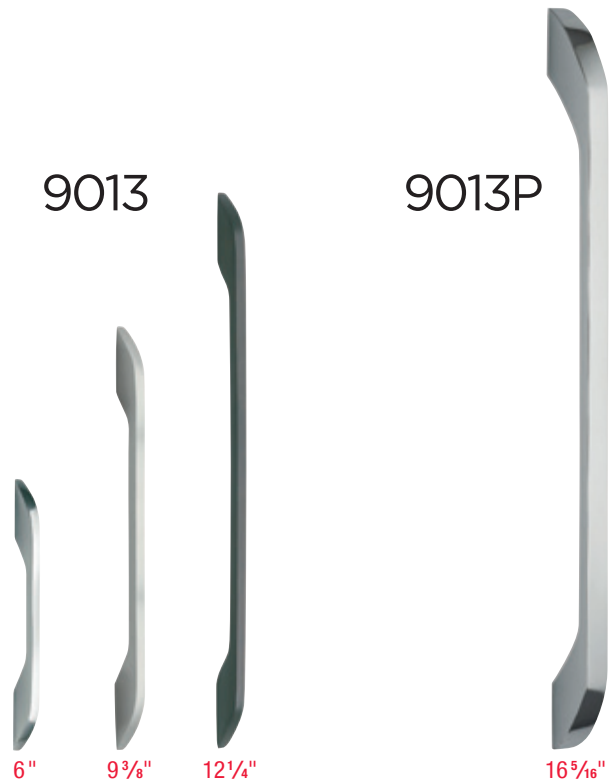

US10B US15 US26

Item#	Center to Center	Overall Length	Proj.	FINISHES		
				US15 US26	US10B	
9013 Cabinet Pull	9013/150	6"	8"	1 1/8"	\$29	\$30
	9013/238	9 3/8"	11"		35	36
	9013/311	12 1/4"	14"		39	41
<i>3/8" w</i>						
9013P Appliance Pull	9013P/415	16 5/16"	17 15/16"	1 7/8"	\$158	\$158
	9013P/415B*	16 5/16"	17 15/16"		158	158
<i>3/4" w at widest point</i>						
<i>*In order to achieve back-to-back, order one regular pull and one B. point</i>						

Suggested retail prices effective August 1, 2020.

TRADITIONS



9030P

9030



	Item#	Center to Center	Overall Length	Max. Dia.	FINISHES		
					US3 US14 US15 US26	US5 US10B	
9030 Cabinet Pull	9030/89	3 1/2"	4"	15/32"	\$13	\$16	
	9030/128	5"	5 1/2"	17/32"	18	21	
	9030/178	7"	7 5/8"	5/8"	32	38	
9030 Appliance Pull	9030/305	12"	12 3/4"	7/8"	\$79	\$92	
	9030/458	18"	18 7/8"	1"	170	196	

9040P

9040



	Item#	Center to Center	Overall Length	Max. Dia.	FINISHES		
					US3 US14 US15 US26	US5 US10B	
9040 Cabinet Pull	9040/89	3 1/2"	4"	9/16"	\$13	\$16	
	9040/128	5"	5 5/8"	5/8"	18	21	
	9040/178	7"	7 5/8"	11/16"	32	38	
9040 Appliance Pull	9040/305	12"	12 7/8"	13/16"	\$79	\$92	
	9040/458	18"	19"	15/16"	170	196	

Suggested retail prices effective August 1, 2020.

TRADITIONS

9045



1"



1 1/4"



1 1/2"



	Item#	Dia.	Proj.	FINISHES					
				US3 US14	US5 US15	US10B US26			
9045 Knob	9045/25	1"	1 1/16"	\$11					
	9045/31	1 1/4"	1 5/16"				18		
	9045/38	1 1/2"	1 1/2"						

Prodigy

9566

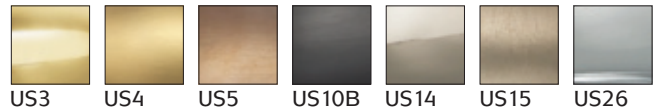

	Item#	Dia.	Proj.	FINISHES		
				US3 US14	US4 US15	US5 US10B US26
9566 Knob	9566	1 5/16"	1 1/16"	\$24		

9936



	Item#	Dia.	Proj.	FINISHES		
				US3 US14	US4 US15	US5 US10B US26
9936 Knob	9936	1 1/4"	1 1/16"	\$24		

9955



	Item#	Dia.	Proj.	FINISHES		
				US3 US14	US4 US15	US5 US10B US26
9955 Knob	9955	1 1/4"	1 1/16"	\$24		

9956



	Item#	Dia.	Proj.	FINISHES		
				US3 US14	US4 US15	US5 US10B US26
9956 Knob	9956	1 1/16"	1 1/16"	\$24		

Suggested retail prices effective August 1, 2020.

STAINLESS STEEL

9457

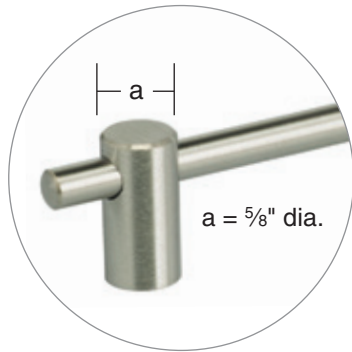

	Item#	Center to Center	Overall Length	Proj.	FINISH US32D
9457 Cabinet Pull 8 mm diameter	9457/96	3 3/4"	5 3/8"	1"	\$27.30
	9457/128	5"	6 5/8"		27.80
	9457/160	6 3/8"	7 7/8"		29.00
	9457/192	7 5/8"	9 1/8"		30.60

9458



	Item#	Center to Center	Overall Length	Proj.	FINISH US32D
9458 Cabinet Pull 12 mm diameter	9458/128	5"	7 1/4"	1 1/4"	\$30.00
	9458/192	7 5/8"	9 3/4"		36.50
	9458/320	12 5/8"	14 15/16"		48.80
	9458/448	17 5/8"	20 1/8"		63.50

Suggested retail prices effective August 1, 2020.

STAINLESS STEEL

9464

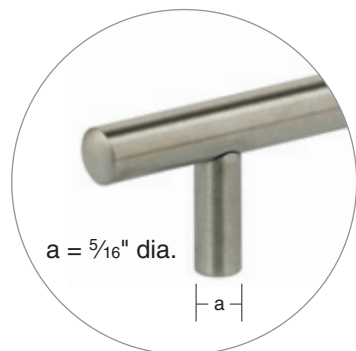

	Item#	Center to Center	Overall Length	Proj.	FINISH US32D
9464 Cabinet Pull 10 mm diameter	9464/76	3"	4 ¹⁵ / ₁₆ "	1 ³ / ₁₆ "	\$12.50
	9464/96	3 ³ / ₄ "	5 ³ / ₄ "		13.50
	9464/128	5"	7"		16.00
	9464/192	7 ⁵ / ₈ "	9 ¹ / ₂ "		20.50
	9464/320	12 ⁵ / ₈ "	14 ⁹ / ₁₆ "		30.00
	9464/448	17 ⁵ / ₈ "	20 ¹ / ₂ "		42.50
	9464/640	25 ³ / ₁₆ "	28 ³ / ₈ "		77.00

9465

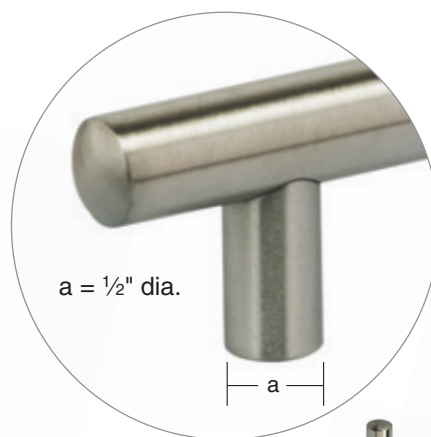

	Item#	Center to Center	Overall Length	Proj.	FINISH US32D
9465 Cabinet Pull 14 mm diameter	9465/96	3 ³ / ₄ "	5 ³ / ₄ "	1 ³ / ₈ "	\$29.00
	9465/128	5"	7"		33.20
	9465/192	7 ⁵ / ₈ "	9 ¹ / ₂ "		41.50
	9465/320	12 ⁵ / ₈ "	14 ⁹ / ₁₆ "		52.00
	9465/448	17 ⁵ / ₈ "	20 ¹ / ₂ "		63.30
	9465/640	25 ³ / ₁₆ "	28 ³ / ₈ "		75.10
	9465/736	29"	32 ¹ / ₄ "		88.80

Suggested retail prices effective August 1, 2020.

STAINLESS STEEL

9450

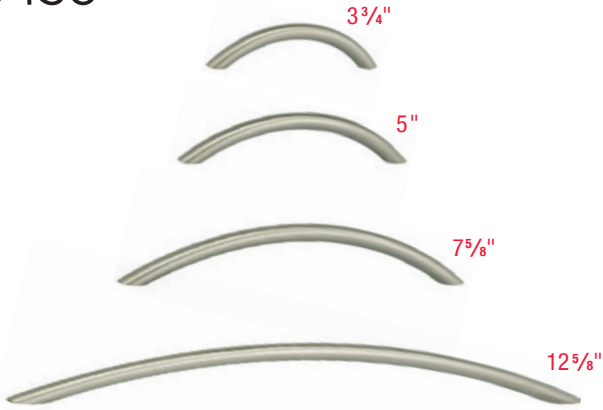

	Item#	Center to Center	Overall Length	Proj.	FINISH US32D
9450 Cabinet Pull 10 mm diameter	9450/96	3 ³ / ₄ "	4 ⁵ / ₈ "	1 ¹ / ₈ "	\$12.40
	9450/128	5"	5 ⁷ / ₈ "	1 ³ / ₁₆ "	13.30
	9450/192	7 ⁵ / ₈ "	8 ³ / ₄ "	1 ³ / ₈ "	18.20
	9450/320	12 ⁵ / ₈ "	14 ⁹ / ₁₆ "		39.00

9533

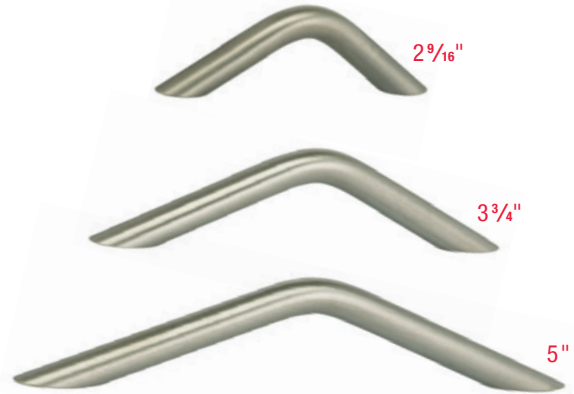

	Item#	Center to Center	Overall Length	Proj.	FINISH US32D
9533 Cabinet Pull 10 mm diameter	9533/64	2 ⁹ / ₁₆ "	3 ⁵ / ₈ "	1 ¹ / ₈ "	\$11.60
	9533/96	3 ³ / ₄ "	5 ³ / ₁₆ "	1 ³ / ₁₆ "	12.20
	9533/128	5"	6 ³ / ₄ "	1 ¹ / ₄ "	13.30

9537

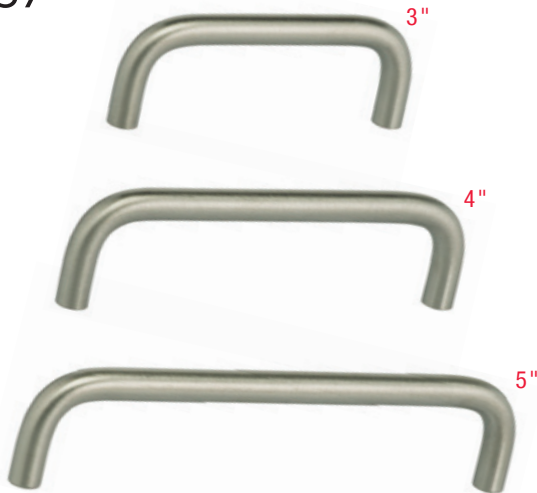

	Item#	Center to Center	Overall Length	Proj.	FINISH US32D
9537 Cabinet Pull 8 mm diameter	9537/76	3"	3 ³ / ₈ "	1 ³ / ₁₆ "	\$10.80
	9537/102	4"	4 ³ / ₈ "		11.10
	9537/128	5"	5 ³ / ₈ "		12.00

9538



	Item#	Center to Center	Overall Length	Proj.	FINISH US32D
9538 Cabinet Pull 10 mm diameter	9538/76	3"	3 ⁷ / ₁₆ "	1 ³ / ₈ "	\$11.80
	9538/102	4"	4 ⁷ / ₁₆ "		12.40
	9538/128	5"	5 ¹ / ₂ "		13.10

Suggested retail prices effective August 1, 2020.

STAINLESS STEEL

9100



1"

1³/₁₆"

	Item#	Dia.	Proj.	FINISH US32D
9100 Knob	9100/25	1"	7/8"	\$10
	9100/30	1 ³ / ₁₆ "	1 ¹ / ₈ "	14

9153



3/4"

13/16"

	Item#	Dia.	Proj.	FINISH US32D
9153 Knob	9153/18	3/4"	1"	\$10
	9153/21	13/16"	1 ¹ / ₈ "	14

9180



1"

1³/₁₆"

	Item#	Dia.	Proj.	FINISH US32D
9180 Knob	9180/25	1"	1 ¹ / ₈ "	\$14
	9180/30	1 ³ / ₁₆ "	1 ¹ / ₄ "	20

9181



3/4"

13/16"

	Item#	Dia.	Proj.	FINISH US32D
9181 Knob	9181/20	3/4"	1"	\$10
	9181/24	15/16"	1 ³ / ₁₆ "	14

Suggested retail prices effective August 1, 2020.

Legacy

9100
Knob



Item#	Dia.	Proj.	FINISHES			
			US3 US26	US10B US26D	US14 VB	US15 VC VI
9100/31	1 7/32"	1 1/8"	\$14			

9102
Knob



Item#	Dia.	Proj.	FINISHES			
			US3 US26	US10B VB	US14 VC	US15 VI
9102/30	1 3/16"	1 1/8"	\$16			

9105
Knob



Item#	Dia.	Proj.	FINISHES			
			US3 US26	US10B US26D	US14 VB	US15 VC VI
9105/35	1 3/8"	1 1/2"	\$14			

9130
Knob



Item#	Dia.	Proj.	FINISHES			
			US3	US14	US15	SB
9130/30	1 3/16"	1 1/16"	\$12			

9141
Knob



Item#	Dia.	Proj.	FINISHES			
			US3 US26	US10B SB	US14 VB	US15 VC VI
9141/30	1 3/16"	1"	\$16			

9158
Knob



Item#	Dia.	Proj.	FINISHES			
			US3 US15	US10B US26	US14	SB
9158/30	1 3/16"	1 5/32"	\$16			

9430
Knob



Item#	Dia.	Proj.	FINISHES			
			US3 US26	US10B SB	US14 VB	US15 VC VI
9430/32	1 1/4"	1 1/4"	\$16			

Suggested retail prices effective August 1, 2020.

Suggested retail prices effective August 1, 2020.

Ornate

7105

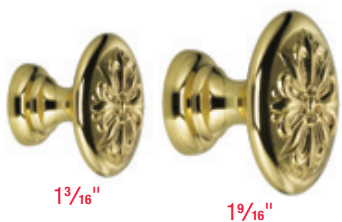

	Item#	Dia.	Proj.	FINISHES		
				US3	US15A	SB
7105 Knob	7105/30	1 3/16"	1"		\$35	
	7105/40	1 9/16"	1 3/16"		50	

7417

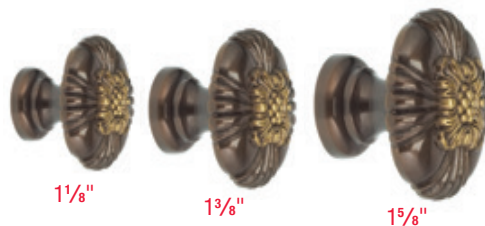

	Item#	Dia.	Proj.	FINISHES		
				US3	US15A	SB
7417 Knob	7417/28	1 1/8"	1"		\$37	
	7417/35	1 3/8"	1 1/8"		44	
	7417/42	1 5/8"	1 3/16"		51	

7420



	Item#	Dia.	Proj.	FINISHES		
				US3	US15A	SB
7420 Knob	7420/28	1 1/8"	1 3/16"		\$33	
	7420/33	1 5/16"	1"		36	
	7420/46	1 13/16"	1 3/16"		50	

7430



	Item#	Dia.	Proj.	FINISHES		
				US3	US15A	SB
7430 Knob	7430/30	1 3/16"	1 1/8"		\$35	
	7430/38	1 1/2"	1 1/8"		48	
	7430/47	1 7/8"	1 1/8"		60	

7432



	Item#	Dia.	Proj.	FINISHES		
				US3	US14	US15A SB
7432 Pull	7432/76	3"	1 3/8"		\$45	
	7432/89	3 1/2"	1 9/16"		52	

7434



	Item#	Dia.	Proj.	FINISHES		
				US3	US15A	SB
7434 Knob	7434/28	1 1/8"	1"		\$32	
	7434/35	1 3/8"	1 3/16"		42	
	7434/42	1 5/8"	1 1/4"		51	

7435



	Item#	Dia.	Proj.	FINISHES		
				US3	US15A	SB
7435 Knob	7435/25	1"	1 3/16"		\$26	
	7435/30	1 3/16"	1"		32	
	7435/40	1 9/16"	1 3/16"		42	

7436



	Item#	Dia.	Proj.	FINISHES		
				US3	US14	US15A SB
7436 Knob	7436/25	1"	1 3/16"		\$26	
	7436/30	1 3/16"	1"		34	
	7436/40	1 9/16"	1 3/16"		47	

STAINLESS STEEL

720 721 722 4010 4019 8190

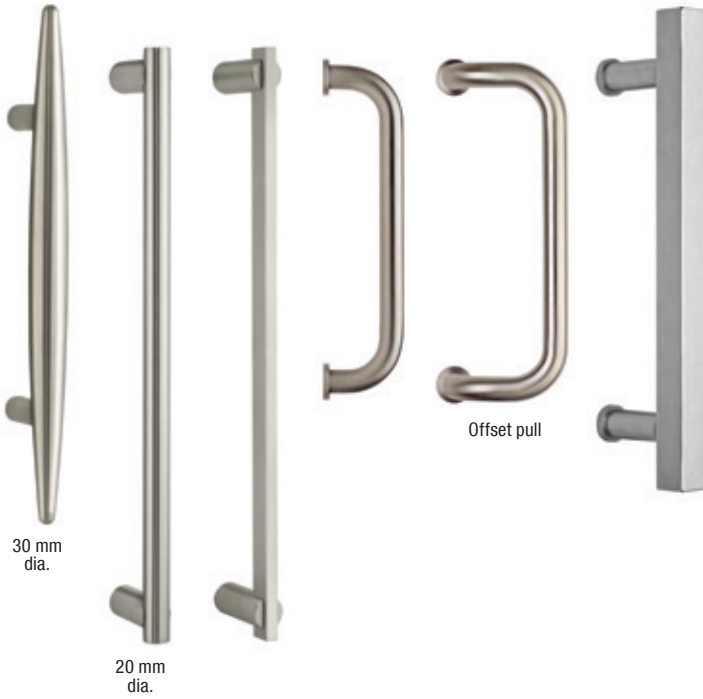

	Item#	Center to Center	Overall Length	Proj.	FINISH US32D
720	720/220	8 ⁵ / ₈ "	15"	2 ³ / ₄ "	\$206
721	721/400	15 ³ / ₄ "	17 ⁵ / ₁₆ "	2 ⁹ / ₁₆ "	\$171
	721/800	31 ¹ / ₂ "	33"	2 ⁹ / ₁₆ "	288
722	722/400	15 ³ / ₄ "	17 ⁵ / ₁₆ "	2 ⁹ / ₁₆ "	\$139
4010	4010/300	8"	9"	2 ⁵ / ₈ "	\$152
	4010/B300	8"	9"	2 ⁵ / ₈ "	323
	4010/400	12"	13 ¹ / ₄ "	2 ¹⁵ / ₁₆ "	201
	4010/B400	12"	13 ¹ / ₄ "	2 ¹⁵ / ₁₆ "	420
	4010/500	16"	17 ¹ / ₂ "	3 ³ / ₈ "	261
	4010/B500	16"	17 ¹ / ₂ "	3 ³ / ₈ "	539
4019	4019/300	8"	9"	2 ⁵ / ₈ "	\$208
	4019/B300	8"	9"	2 ⁵ / ₈ "	434
	4019/400	12"	13 ¹ / ₄ "	2 ¹⁵ / ₁₆ "	257
	4019/B400	12"	13 ¹ / ₄ "	2 ¹⁵ / ₁₆ "	531
	4019/500	16"	17 ¹ / ₂ "	3 ³ / ₈ "	315
	4019/B500	16"	17 ¹ / ₂ "	3 ³ / ₈ "	648
8190	8190/300	11 ¹³ / ₁₆ "	15 ³ / ₄ "	3 ⁹ / ₁₆ "	\$312
	8190/B300	11 ¹³ / ₁₆ "	15 ³ / ₄ "	3 ⁹ / ₁₆ "	653
	8190/400	15 ³ / ₄ "	23 ³ / ₈ "	3 ⁹ / ₁₆ "	331
	8190/B400	15 ³ / ₄ "	23 ³ / ₈ "	3 ⁹ / ₁₆ "	687

For full Stainless Steel line, please see pages 19–23.

All pulls are available back-to-back.

ELITE

1968P 1969P 1970P 1971P

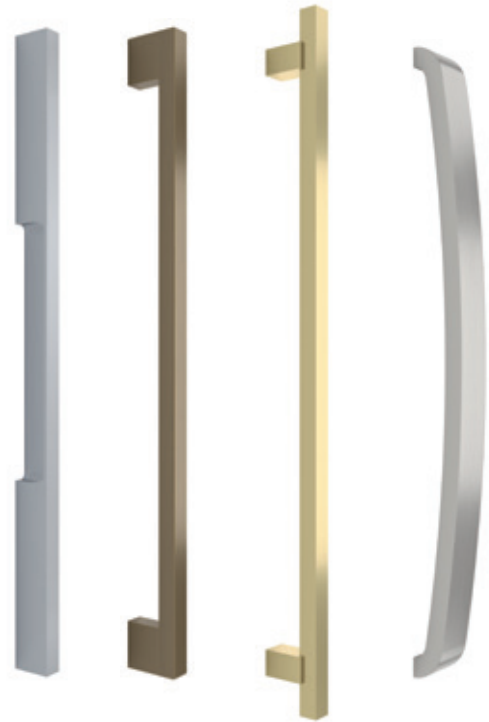

Item#	Center to Center	Overall Length	Proj.	FINISHES	
				US4 US14 US26	US5 US10B US15
1968P 19/32" W	1968P/305	12"	12 ¹⁵ / ₁₆ "	1 ³ / ₁₆ "	\$175 \$185
	1968P/305B*	12"	12 ¹⁵ / ₁₆ "	1 ³ / ₁₆ "	175 185
	1968P/457	18"	18 ¹⁵ / ₁₆ "	1 ³ / ₁₆ "	225 235
	1968P/457B*	18"	18 ¹⁵ / ₁₆ "	1 ³ / ₁₆ "	225 235
1969P 19/32" W	1969P/305	12"	13 ¹ / ₈ "	1 ³ / ₄ "	\$190 \$198
	1969P/305B*	12"	13 ¹ / ₈ "	1 ³ / ₄ "	190 198
	1969P/457	18"	19 ¹ / ₈ "	1 ³ / ₄ "	235 240
	1969P/457B*	18"	19 ¹ / ₈ "	1 ³ / ₄ "	235 240
1970P 13/16" W	1970P/305	12"	14 ³ / ₄ "	1 ³ / ₄ "	\$190 \$198
	1970P/305B*	12"	14 ³ / ₄ "	1 ³ / ₄ "	190 198
	1970P/457	18"	20 ³ / ₄ "	1 ³ / ₄ "	235 240
	1970P/457B*	18"	20 ³ / ₄ "	1 ³ / ₄ "	235 240
1971P 1 ³ / ₁₆ " W	1971P/305	12"	12 ¹¹ / ₁₆ "	1 ³ / ₄ "	\$175 \$185
	1971P/305B*	12"	12 ¹¹ / ₁₆ "	1 ³ / ₄ "	175 185
	1971P/457	18"	18 ⁹ / ₁₆ "	1 ³ / ₄ "	225 235
	1971P/457B*	18"	18 ⁹ / ₁₆ "	1 ³ / ₄ "	225 235

*In order to achieve back-to-back, order one regular pull and one B.

For full Elite line, please see pages 4–5.

Suggested retail prices effective August 1, 2020.

TRADITIONS

9030P 9040P



Item#	Center to Center	Overall Length	Proj.	FINISHES		
				US3 US14 US15 US26	US5 US10B	
9030P	9030P/305	12"	12 ³ / ₄ "	7/8"	\$79	\$92
	9030P/458	18"	18 ⁷ / ₈ "	1"	170	196
9040P	9040P/305	12"	12 ⁷ / ₈ "	1 ³ / ₁₆ "	\$79	\$92
	9040P/458	18"	19"	1 ⁵ / ₁₆ "	170	196

For full Traditions line, please see pages 16–17.

Ultima I

9006P 9007P 9009P 9013P



Item#	Center to Center	Overall Length	Proj.	FINISHES	
				US15 US10B US26	
9006P 1" w	9006P/440	17 ⁵ / ₁₆ "	17 ¹⁵ / ₁₆ "	2"	\$196
	9006P/440B*	17 ⁵ / ₁₆ "	17 ¹⁵ / ₁₆ "	2"	196
9007P 5/8" w	9007P/400**	17 ⁵ / ₁₆ "	17 ¹⁵ / ₁₆ "	2"	\$146
9009P 7/8" w at widest point	9009P/415	16 ⁵ / ₁₆ "	18"	2 ⁵ / ₈ "	\$256
	9009P/415B*	16 ⁵ / ₁₆ "	18"	2 ⁵ / ₈ "	256
9013P 3/4" w (not square)	9013P/415	16 ⁵ / ₁₆ "	17 ¹⁵ / ₁₆ "	1 ⁷ / ₈ "	\$158
	9013P/415B*	16 ⁵ / ₁₆ "	17 ¹⁵ / ₁₆ "	1 ⁷ / ₈ "	158

*In order to achieve back-to-back, order one regular pull and one B.

**Not available back-to-back.

For full Ultima I line, please see pages 13–15.

Suggested retail prices effective August 1, 2020.

Ultima II

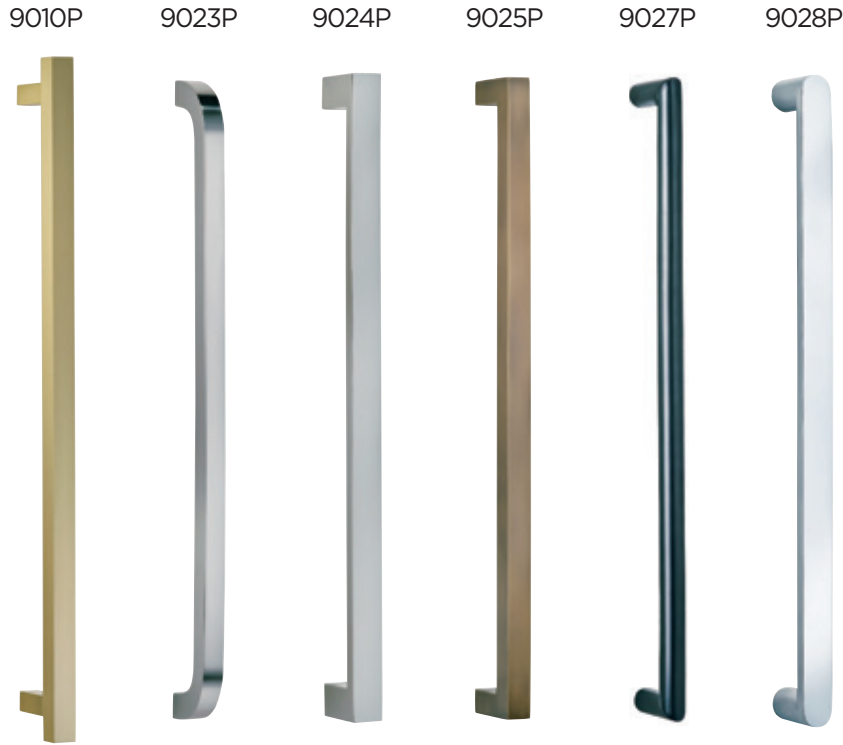

	Item#	Center to Center	Overall Length	Proj.	FINISHES		
					US4 US14 US15 US26	US5 US10B	
9010P 3/4" w	9010P/305	12"	14"	2 ⁵ / ₁₆ "	\$152	\$175	
	9010P/305B*	12"	14"	2 ⁵ / ₁₆ "	152	175	
	9010P/457	18"	20"	2 ⁵ / ₁₆ "	214	246	
	9010P/457B*	18"	20"	2 ⁵ / ₁₆ "	214	246	
9023P 5/8" w	9023P/305	12"	12 ³ / ₄ "	2 ³ / ₁₆ "	\$148	\$170	
	9023P/305B*	12"	12 ³ / ₄ "	2 ³ / ₁₆ "	148	170	
	9023P/457	18"	18 ³ / ₄ "	2 ³ / ₁₆ "	205	236	
	9023P/457B*	18"	18 ³ / ₄ "	2 ³ / ₁₆ "	205	236	
9024P 1" w	9024P/305	12"	13"	2"	\$132	\$152	
	9024P/305B*	12"	13"	2"	132	152	
	9024P/457	18"	19"	2"	178	204	
	9024P/457B*	18"	19"	2"	178	204	
9025P 3/4" w	9025P/305	12"	12 ³ / ₄ "	2"	\$151	\$174	
	9025P/305B*	12"	12 ³ / ₄ "	2"	151	174	
	9025P/457	18"	18 ³ / ₄ "	2"	212	244	
	9025P/457B*	18"	18 ³ / ₄ "	2"	212	244	
9027P 3/4" w	9027P/305	12"	12 ³ / ₄ "	2"	\$120	\$138	
	9027P/305B*	12"	12 ³ / ₄ "	2"	120	138	
	9027P/457	18"	18 ³ / ₄ "	2"	167	193	
	9027P/457B*	18"	18 ³ / ₄ "	2"	167	193	
9028P 3/4" w	9028P/305	12"	13"	2"	\$126	\$145	
	9028P/305B*	12"	13"	2"	126	145	
	9028P/457	18"	19"	2"	167	193	
	9028P/457B*	18"	19"	2"	167	193	

*In order to achieve back-to-back, order one regular pull and one B.

For full Ultima II line, please see pages 10–12.

Suggested retail prices effective August 1, 2020.

Ultima III



	Item#	Center to Center	Overall Length	Proj.	FINISHES			
					US3A	US4	US5	US10B
					US14	US15	US26	
9029P 3/4" w	9029P/305	12"	12 3/4"	2 3/16"	\$201			
	9029P/305B*	12"	12 3/4"	2 3/16"	201			
	9029P/457	18"	18 3/4"	2 3/16"	298			
	9029P/457B*	18"	18 3/4"	2 3/16"	298			
9031P 3/4" w	9031P/305	12"	12 3/4"	2 3/16"	\$215			
	9031P/305B*	12"	12 3/4"	2 3/16"	215			
	9031P/457	18"	18 3/4"	2 3/16"	320			
	9031P/457B*	18"	18 3/4"	2 3/16"	320			
9037P 7/16" max. dia.	9037P/305	12"	12 3/4"	2 1/8"	\$201			
	9037P/305B*	12"	12 3/4"	2 1/8"	201			
	9037P/457	18"	18 3/4"	2 1/8"	298			
	9037P/457B*	18"	18 3/4"	2 1/8"	298			
9038P 3/4" max. dia.	9038P/305	12"	12 3/4"	2 1/8"	\$181			
	9038P/305B*	12"	12 3/4"	2 1/8"	181			
	9038P/457	18"	18 3/4"	2 1/8"	247			
	9038P/457B*	18"	18 3/4"	2 1/8"	247			
9039P 1 3/16" w	9039P/305	12"	12 3/4"	2 1/8"	\$201			
	9039P/305B*	12"	12 3/4"	2 1/8"	201			
	9039P/457	18"	18 3/4"	2 1/8"	298			
	9039P/457B*	18"	18 3/4"	2 1/8"	298			

*In order to achieve back-to-back, order one regular pull and one B.

For full Ultima III line, please see pages 6–8.

Suggested retail prices effective August 1, 2020.

Flushcups • Solid Brass & Stainless Steel

652



L x W x D	FINISHES		
	US3	US10B US15	US26 US26D
4 3/8" x 1 1/16" x 1/2"	\$35	\$39	\$36

653



L x W x D	FINISHES			
	US3	US10B	US15	US26 US26D
4" x 1 3/4" x 1/2"	\$33	\$44	\$38	\$34

654



L x W x D	FINISHES		
	US3	US14 US15	US26 SB
4" x 1 3/4" x 1/2"	\$35	\$40	\$35

4297



L x W x D	FINISHES	
	US3	SB
5 3/8" x 1 1/16" x 1/2"	\$78	\$81

7500



Dia.	Depth	FINISH
		US32D
2 9/16"	5/8"	\$19

7501



Dia.	Depth	FINISH
		US32D
2"	5/8"	\$18

7502



Dia.	Depth	FINISH
		US32D
1 3/8"	1/2"	\$23

7503



Dia.	D	FINISHES					
		US3	SB	US32D			
2 3/16"	3/8"	US10B	US14	US15	US26	\$43	\$13

7504



Dia.	Depth	FINISHES						
		US3	US32D					
2 3/16"	3/8"	US10B	US14	US15	US26	SB	\$43	\$13

7505



L x W x D	FINISH
	US32D
4 3/4" x 1 1/16" x 1/2"	\$18

7506



L x W x D	FINISH
	US32D
4" x 2" x 1/2"	\$18

7507



Dia.	Depth	FINISH
		US32D
3 9/16"	1 3/16"	\$23

Suggested retail prices effective August 1, 2020.

Pocket Door Flushcups • Solid Brass & Stainless Steel

7012



L x W x D
5" x 2 1/4" x 1/2"
Proj. 3/32"
US32D \$68



US32D

7035



L x W x D
7" x 2 9/32" x 3/8"
Proj. 3/32"
ALL FINISHES \$79

7036



L x W x D
4 1/2" x 2 9/32" x 3/8"
Proj. 3/32"
ALL FINISHES \$68

7037



L x W x D
7" x 2 9/32" x 7/16"
Proj. 1/8"
ALL FINISHES \$79

7039



L x W x D
7" x 2 9/32" x 7/16"
Proj. 1/8"
ALL FINISHES \$79



US3 US3A US4 US5 US10B US14 US15 US26 US26D

Drop Rings & Flushcup • Solid Brass

9580



Item#	Dia.	Depth	FINISHES		
			US3 SB	US4 US14 US15	
9580/50	2"	3/8"	\$20	\$23	

9588



Item#	L x W x D	FINISHES		
		US3 SB	US4 US14 US15	
9588/60	2 3/8" x 1 7/8" x 3/8"	\$19	\$23	

9595



Item#	Dia.	Depth	FINISHES		
			US3	US4 US14 US15	SB
9595/50	2"	1/2"	\$16	\$18	\$16
9595/60	2 3/8"	9/16"	19	23	20

Suggested retail prices effective August 1, 2020.

Door Stops • Solid Brass & Stainless Steel

1147



Proj.	FINISHES			
	US3	US15	US10B	US26 US26D SB
3"		\$15		

1148



Proj.	FINISHES			
	US3	US15	US10B	US26 US26D SB
3¾"		\$17		

2001



Throw	Overall Length	Max. Width	FINISHES	
			US3	US26
2"	7¼"	1⅛"	\$45	

Plunger Door Holder

Operates by stepping on plunger, which is fitted with a white rubber tip. Hold door firmly in any position. Releases by stepping on trigger plate.

7001



Dia.	Ht.	FINISHES				
		US3	US4	US10B	US14	US15
7/8"	1¾"			\$36		

7602



Dia.	Ht.	FINISH
		US32D
1"	1⅛"	\$35

7605



Dia.	Proj.	FINISH
		US32D
1"	3¾"	\$52

7610



Item#	Dia.	Ht.	FINISH
			US32D
7610	1"	1⅜"	\$18
7610/51	1"	2"	28

7000



Item#	Dia.	Ht.	FINISHES				
			US3	US4	US10B	US32D	SB
7000	1⅛"	1⅛"	\$33	\$36	\$38	\$31	\$41
7000/55	1⅛"	2⅜"	N/A	N/A	N/A	39	N/A

7620



Sq.	Ht.	FINISH
		US32D
1"	1⅜"	\$43

Ball Catch • Solid Brass

1600F



Faceplate: 2⅛" L x 1" W
 Strike Plate: 2⅛" L x 1⅜" W
 Barrel: ¾" Dia. x 1¼ L

Item#	FINISHES			
	US3	US4	US10B	US14
1600F			\$26	

1600F* 1600F
Ball Catch

*Ball projection is adjustable.

Suggested retail prices effective August 1, 2020.

Latch & Decorative Hooks • Solid Brass

156



Not Handed

	Height	Lever Width	FINISHES	
			US3	US26
156 Shutter Latch / Bi-fold Door Latch	2"	2 ³ / ₈ "	\$21	

210



	Height	Proj.	FINISHES	
			US3	US26
210 Double Hook	3"	3"	\$21	

212



	Height	Proj.	FINISHES	
			US3	US26
212 Hook	1 ⁵ / ₈ "	1 ⁵ / ₁₆ "	\$12	

213



	Height	Proj.	FINISHES	
			US3	US26
213 Double Hook	1 ¹ / ₂ "	³ / ₄ "	\$12	

215



	Base	Proj.	FINISHES	
			US3	US26
215 Triple Swivel Hook	3 ¹ / ₂ " x 1 ³ / ₄ "	4 ⁵ / ₁₆ "	\$121	\$135

Suggested retail prices effective August 1, 2020.

Switchplates • Solid Brass

8004



8004/S SINGLE



8004/D DOUBLE

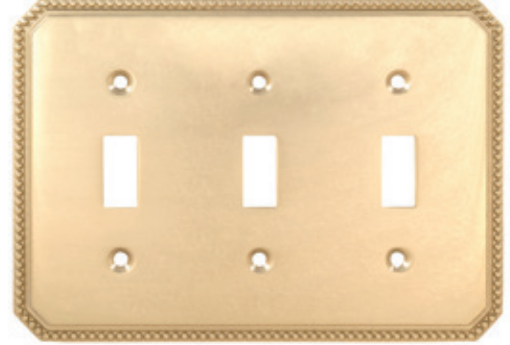

8004/T TRIPLE



8004/R DUPLEX RECEPTACLE



8004/C COMBINATION

Item#	FINISHES			
	US3	US15	US26 SB	
8004 Beaded Design	8004/S	\$24	\$29	\$27
	8004/D	36	40	39
	8004/T	44	50	46
	8004/R	24	29	27
	8004/C	36	40	39

8005



8005/S SINGLE

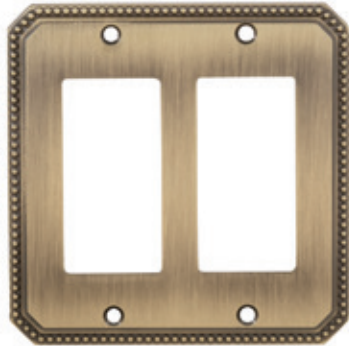

8005/D DOUBLE

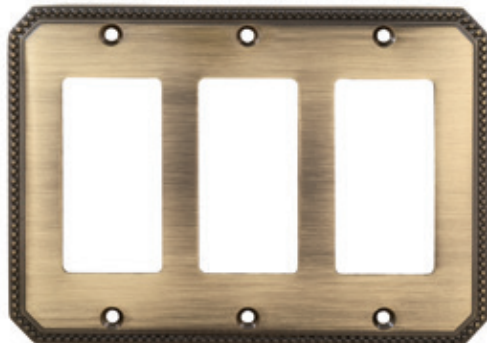

8005/T TRIPLE

Item#	FINISHES			
	US3	US15	US26 SB	
8005 Beaded Design	8005/S	\$24	\$29	\$27
	8005/D	36	40	39
	8005/T	44	50	46

Suggested retail prices effective August 1, 2020.

Switchplates • Solid Brass

8012



8012/S SINGLE



8012/D DOUBLE



8012/T TRIPLE



8012/R DUPLEX RECEPTACLE



8012/C COMBINATION

Item#	FINISHES		
	US3	US15	US26 SB
8012			
Modern			
Design			
8012/S	\$23	\$27	\$24
8012/D	34	39	35
8012/T	42	47	44
8012/R	23	27	24
8012/C	34	39	35

8023



8023/S SINGLE



8023/D DOUBLE

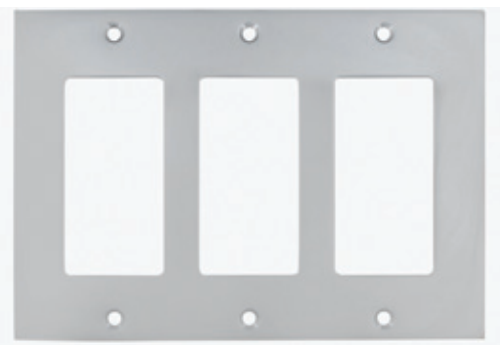

8023/T TRIPLE

Item#	FINISHES		
	US3	US15	US26 SB
8023			
Modern			
Design			
8023/S	\$22	\$27	\$24
8023/D	34	39	35
8023/T	42	47	44

Suggested retail prices effective August 1, 2020.

Switchplates • Solid Brass

8014



8014/S SINGLE



8014/D DOUBLE



8014/T TRIPLE



8014/R DUPLEX RECEPTACLE



8014/C COMBINATION

Item#	FINISHES		
	US3	US15	US26 US26D SB
8014			
8014/S	\$24	\$27	\$24
8014/D	35	40	38
8014/T	43	49	45
8014/R	24	27	24
8014/C	35	40	38

8024



8024/S SINGLE



8024/D DOUBLE

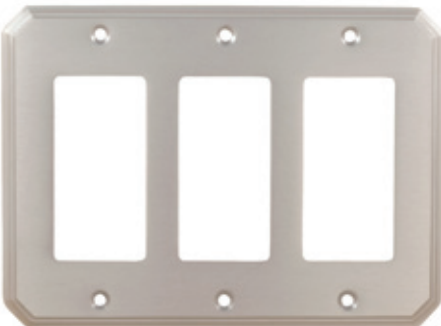

8024/T TRIPLE

Item#	FINISHES		
	US3	US15	US26 US26D SB
8024			
8024/S	\$24	\$27	\$24
8024/D	35	40	38
8024/T	43	49	45

Suggested retail prices effective August 1, 2020.

OMNIA TERMS & CONDITIONS OF SALE

(as of January 1, 2020)

WARRANTIES

Limited Mechanical Warranty

OMNIA Industries, Inc. ("OMNIA") offers to the original owner a Limited Warranty that all OMNIA products shall be free of mechanical abnormality for the duration that the original owner inhabits the residence in which the product was originally installed.

Exclusions

Any OMNIA product having an abnormality due to improper installation, forced entry, failure to exercise normal maintenance or against the consequences of uses for which our products were not designed is not covered by this warranty. Additionally, if an OMNIA product or component part is used with a product that is not ours or a component part (such as an OMNIA lock or latch with non-OMNIA knobs, levers, escutcheons and roses), any warranty shall be null and void. Warranty does not cover normal wear and tear.

FINISH WARRANTIES

(Includes General Maintenance)

Stainless Steel

OMNIA warrants its stainless steel finish shall be free from abnormalities in material and workmanship from tarnishing or rusting for either five (5) years from date of purchase for interior use or one (1) year from the date of purchase on exterior doors only for the duration that the original owner inhabits the residence in which the product was originally installed. Exposure to certain chemical or environmental conditions may promote surface oxidation. Please be aware that this is not an abnormality in the stainless steel but a reaction on the surface of the finish to the chemical environment which can be removed with a stainless steel polish or an abrasive pad. **Surface oxidation is not considered an abnormality in the product.**

Stainless Steel PVD

The OMNIA PVD finishes use an advanced finishing technology (Physical Vapor Deposition) to create a finish highly resistant to the effects of weather and normal use. For OMNIA products purchased with PVD finishes, OMNIA warrants the finish shall be free from abnormalities in materials and workmanship from tarnishing, flaking or pitting for the **Lifetime** of the applicable product for the duration that the original owner inhabits the residence in which the product was originally installed. Although the OMNIA PVD finishes are highly resistant to the effects of weather and normal use, they do require periodic maintenance. A build-up may occur if it is not performed, which may create a haze or darker look to the finish.

This is neither tarnish nor an abnormality in the PVD finish. OMNIA PVD finishes can be maintained simply by wiping with a soft cloth and glass cleaner; or as an alternative, a non-abrasive metal polish which can be purchased at any hardware store. Rubbing alcohol may also be used to clean the surface of PVD finishes. **DO NOT use metal polishes that contain abrasives.**

Remaining Finishes

OMNIA warrants its finishes (excluding unlacquered finishes, stainless steel and stainless steel PVD) shall be free from abnormalities in materials and workmanship from tarnishing, flaking or pitting for either five (5) years from date of purchase for interior use or one (1) year from the date of purchase for use on exterior doors only for the duration that the original owner inhabits the residence in which the product was originally installed. Only use damp cloth to clean surface of finish to remove dirt and grime. **DO NOT use household cleaners and/or chemicals.**

Exclusions

Any OMNIA product having an abnormality due to neglect, misuse, abuse or unreasonable or extraordinary use or lack of normal maintenance is not covered by this warranty. In addition, any OMNIA product having an abnormality due to use of paints, solvents or other chemicals is not covered by this warranty. Finishes will not be warranted for any OMNIA product installed on an exterior metal door.

FOR ALL WARRANTIES, PLEASE NOTE:

OMNIA is not responsible for labor charges related to installation, repair or replacement of any product under this warranty. OMNIA's liability under this warranty shall not exceed the sale price of the product.

PRICES

Prices are subject to change without notice. Invoices will reflect prices in effect at time of shipment. OMNIA is not responsible for errors and/or omissions which may appear in any printed material. Orders held by OMNIA because of credit status may be repriced to pricing in effect on date of order release by OMNIA Credit Department.

RETURNED GOODS AUTHORIZATION (RGAs)

All requests for RGAs must be made within 60 days of original invoice date. RGA numbers are valid for 30 days from date of issuance and will not be re-issued. There is a minimum 25% restock fee, plus a freight charge, for all unused and undamaged items returned in original condition. All returns must be

accompanied with a factory issued RGA#. If a factory abnormality is claimed, an RGA will be issued for inspection purposes only. Any credit due will be determined upon inspection. Reordered or replacement materials will be billed when shipped. Returns will be credited after inspection and approval. All returns must be shipped freight prepaid. COD returns will be refused. Special order or discontinued items will not be accepted for return.

ORDERS & SPECIFICATIONS

OMNIA has the right to not accept orders in part or whole if the quantity, finishes or prices requested are not suitable. Packing, weights, measurements and designs are subject to change without notice.

DISCONTINUED ITEMS & D/O

OMNIA may discontinue product or alter specifications at any time without prior notification or obligation. D/O designates a product which will continue to be available as long as inventory remains, after which the product will be discontinued. This program is intended to help our customers anticipate future needs and to avoid bidding or taking orders on parts which may not be available in sufficient quantities when needed.

SAMPLE PROGRAM

Cabinet Hardware

Samples of cabinet pulls up to 6" and cabinet knobs up to 1 1/4" dia. are available free of charge with a \$10 shipping fee for each item ordered. A maximum of 3 samples can be ordered. If ordering more than one sample, the additional samples must all be different part numbers.

Door Hardware

Single dummy samples of door knobs and levers with a list price value up to \$75 are available free of charge with a \$20 shipping fee for each item ordered. For single dummy samples with a list price value of \$76 and over, there is a \$30 shipping fee for each item ordered.

For each sample ordered, you will receive a discount coupon in the amount of the shipping fee. For each \$100 list purchase made through an authorized OMNIA dealer, you may apply one discount coupon. Since there is no charge for the product samples themselves, they cannot be returned to OMNIA for product credit.

If you are interested in a sample of a product other than cabinet hardware or single dummies, please contact OMNIA for shipping costs.

An Authorized OMNIA dealer may request a complete Dealer Terms & Conditions by emailing info@OMNIAindustries.com.



OMNIA

SINCE 1964

5 Cliffside Drive • Box 330
Cedar Grove, New Jersey 07009
tel 973.239.7272 / fax 973.239.5960
order desk fax 800.542.7611
www.OMNIAindustries.com

