

THIS DRAWING IS FOR SPATIAL CONSIDERATION ONLY, AND SUBJECT TO CHANGE W/O PREVIOUS NOTICE, DO NOT PRE-PLUMB TO THESE DIMENSIONS

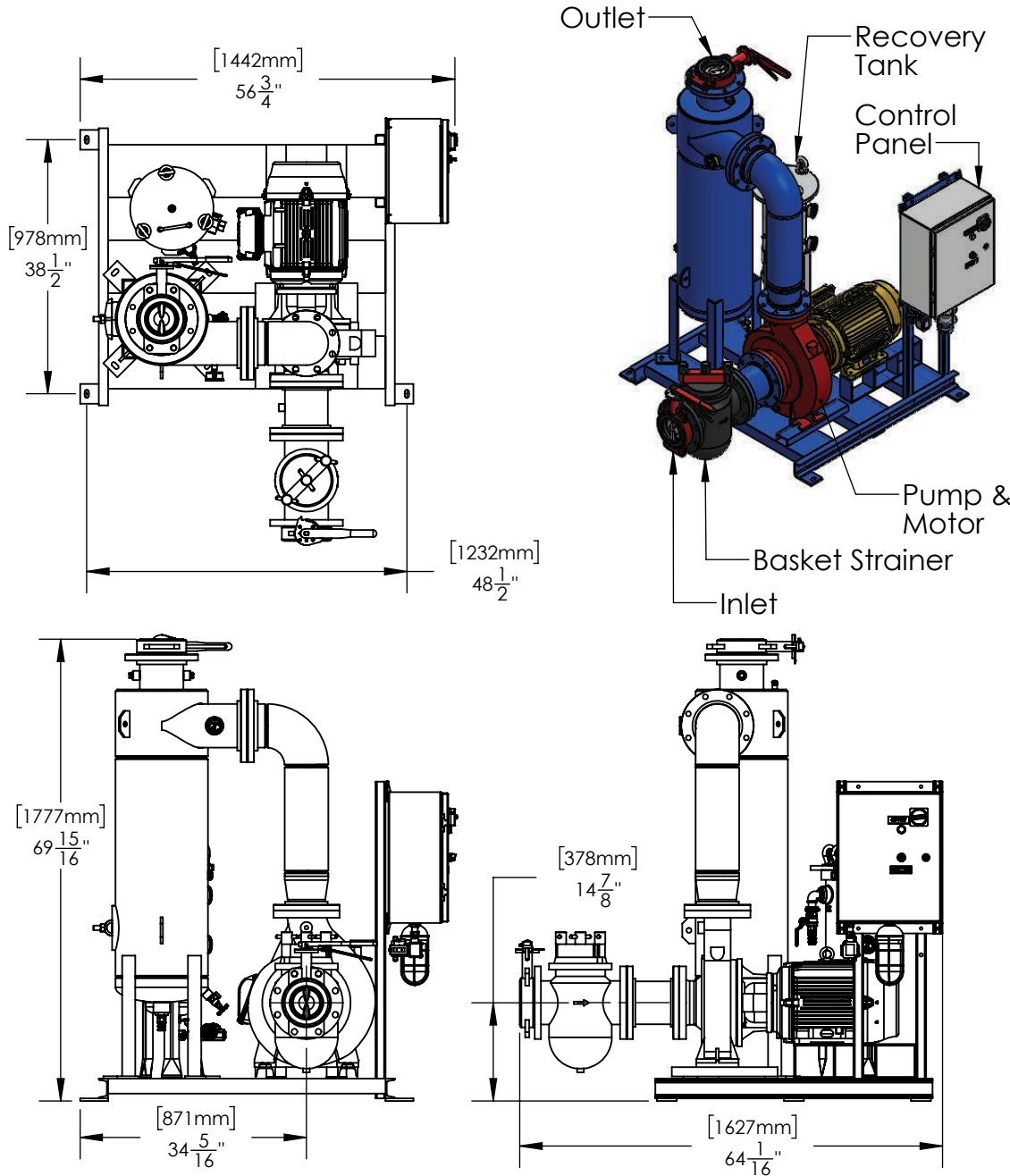

### CSR600-HH

Operating Point	825 GPM @ (US) 80' TDH		
Separator - Size & Style	CS-6T-FLG, Carbon Steel, Powder Coated		
Frame Construction	Carbon Steel (Welded), Powder Coated		
Pipe Assy - Construction	Carbon Steel (Welded), Powder Coated		

#### ELECTRICAL - Motor & System

Horsepower (HP)	25		
Power - Volts / Hz	460/60	575/60	230/60
RPM	1750	1750	1750
Motor Amperage	34	27	68
System Total Amperage	36	29	70

#### PUMP

Installation	Flooded Suction Required
Case Material	Cast Iron
Impeller Material	304
Mechanical Seal	EPDM - Carbon / Ceramic

#### BASKET STRAINER (Optional)

Body Construction	Cast Iron
Strainer Mesh	Stainless Steel 1/4" perforations
Connection - Type & Size	6" FLG (150#)

#### CONTROL PANEL (UL Listed & Labeled. Manufactured to UL 508A)

Enclosure (UL listed & CSA approved)	NEMA 4 (STD) - Carbon Steel, Powder Coated NEMA 4X (Optional) - 304
Electrical Components (UL listed & CSA approved)	Thermal Overload Starter, HOA, XFMR, "RUN" Light, Door Disconnect, Contactor

#### PROCESS INLET

Connection - Type & Size	6" FLG (150#) - Butterfly Valve
--------------------------	---------------------------------

#### PROCESS OUTLET

Connection - Type & Size	6" FLG (150#) - Butterfly Valve
--------------------------	---------------------------------

#### PURGE - RT (Recovery Tank)

Recovery Tank	RT-1
Connection Type	RTM-10

#### PRESSURE - Maximum Operating

Pump Inlet	100 psi (6.9 bar)
Vessel	150 psi (10.3 bar)

#### TEMPERATURE - Maximum Operating

System	34°F - 122°F (1°C - 50°C)
--------	---------------------------

WEIGHTS	DRY	SHIPPING	OPERATING
lbs (kg)	1515 (687)	1703 (773)	1933 (877)

\*UNLESS OTHERWISE SPECIFIED - ALL DIMENSIONS ARE IN INCHES

PREPARED BY: JASON WU

PAGE: 1

RELEASED BY: BOB KAZANJY

DATE: 7/22/2019

REV: A



General Water Systems | P. O. Box 444 | Desert Hot Spring | CA | 92204  
www.gwslp.com | info@gwslp.com | 951.213.9506 | 386.255.3909

### CSR600-HH