



**USA GYMNASTICS®**

**2019 - 2020  
Women's Program  
Rules and Policies**

**Governing Competitors and Competitions  
Sanctioned by the**

**National Women's  
Program Committee**

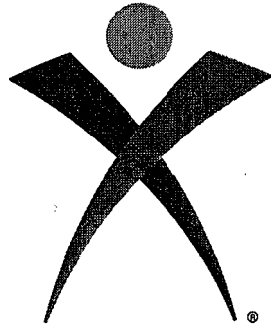

USA GYMNASTICS®

**2019 - 2020**

**Women's Program Rules and  
Policies**

Governing Competitors and  
Competitions sanctioned by the

**National Women's  
Program  
Committee**

VERSION 1

Last

Updated

7/31/2019

## Table of Contents

National Women’s Program Committee Structure	1
Officers and Staff Directory	2
USA Gymnastics Hotline	9
USA Gymnastics Women’s Regional Map	10
Introduction, Purpose and Code of Ethical Conduct	11
Chapter One: Membership	18
Athlete Membership	18
Professional Membership and Responsibilities	19
Judges’ Responsibilities	22
Chapter Two: Foreign Policy	24
Chapter Three: Sanctions	28
Chapter Four: Meet Director Responsibilities	31
Chapter Five: Meet Officials	34
Criteria for Selection	37
Rating Chart	39
Duties of Meet Officials	41
Judge’s Compensation Package	42
Chapter Six: Xcel Competitive Program	47
Age and Entry Requirements	47
General Petition Procedures	49
Types of Competition	50
State Championships	51
Regional Championships	52
Apparatus Requirements	53
Chapter Seven: Xcel General Meet Information	61
Meet Format	62
Meet Warm-ups	67
Specific Competition Procedures	70
Awards	74
Chapter Eight: Junior Olympic Competitive Program	77
Age and Entry Requirements	77
General Petition Procedures	80
Types of Competition	81
State Championships	82
Regional Championships	83
Eastern/Western Championships – Level 9	86
Junior Olympic Nationals – Level 10	88
Apparatus Requirements	91
Chapter Nine: Junior Olympic General Meet Information	98
Meet Format	99
Meet Warm-ups	104
Specific Competition Procedures	107
Awards	112
Chapter Ten: Elite Program	115
Camps, Age Determination, Mobility	117
Injury Replacement, Petitions	118
Qualifying Scores and Procedures	119
TOPS	120
Foreign Athlete Participation	121
Apparatus	122

New Material is highlighted in yellow.

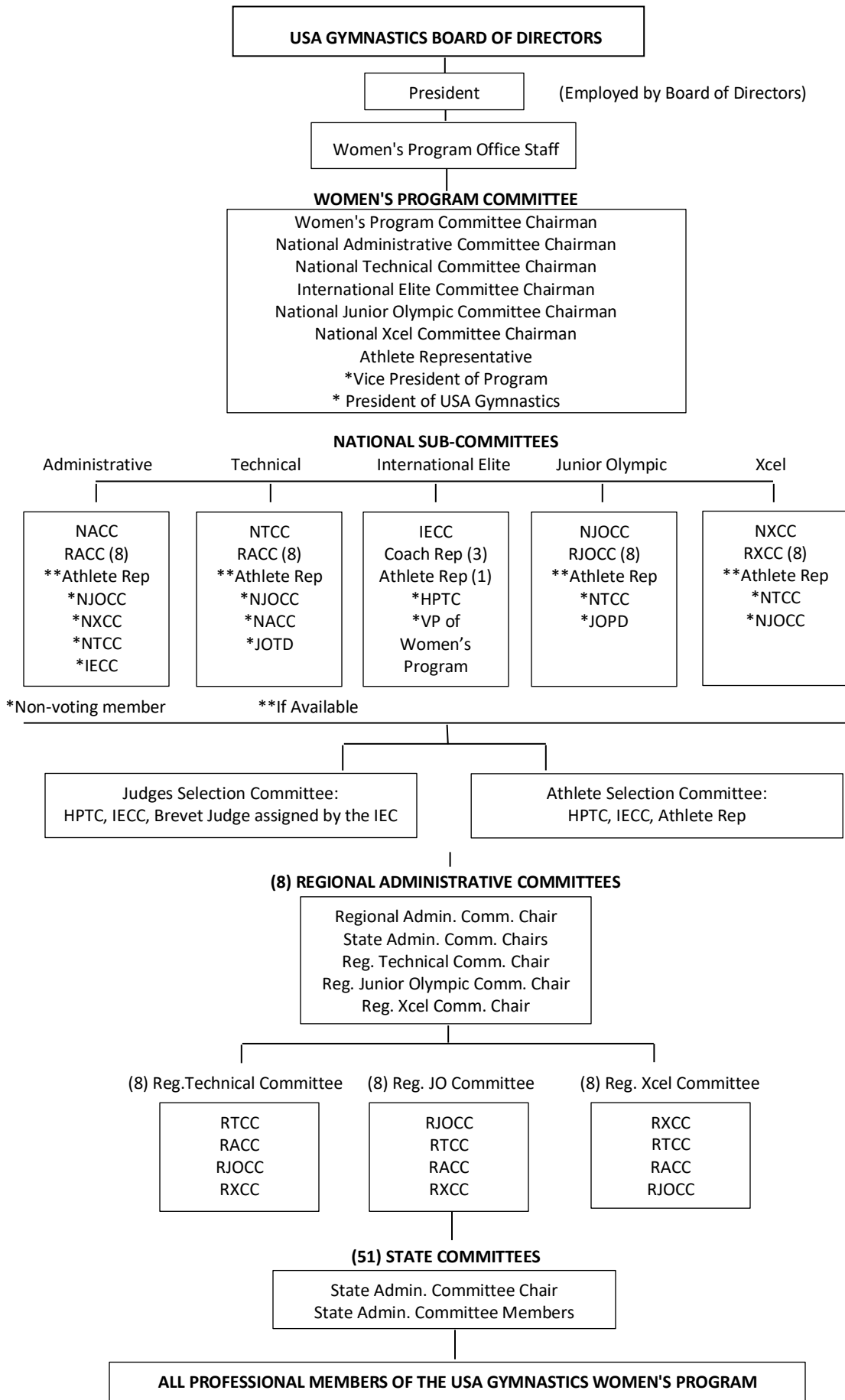

**NATIONAL OFFICERS OF WOMEN'S SUB-COMMITTEES  
2018-2019**

Position	First Name	Last Name	Street Address	City	State	Zip Code	Email
National Administrative Committee Chairman	Cori	Rizzo	7626 Paradise River Dr.	Sugar Land	TX	77479	<a href="mailto:coririzzo@gmail.com">coririzzo@gmail.com</a>
Cell Phone: 512-797-5774							
National Junior Olympic Committee Chairman	Tom	Koll	7701 Davis Circle	Omaha	NE	68134	<a href="mailto:tkoll60@gmail.com">tkoll60@gmail.com</a>
Cell Phone: 402-213-7701      Gym/Work Phone: 402-571-6630      Fax Number: 402-571-9522							
International Elite Committee Chairman	Kelli	Hill	7757 Lindbergh Drive	Gaithersburg	MD	20879	<a href="mailto:kelli@hillsgymnastics.com">kelli@hillsgymnastics.com</a>
Gym/Work Phone: 301-840-5900							
National Technical Committee Chairman	Cheryl	Hamilton	21 Arizona State Drive	Newark	DE	19713	<a href="mailto:Cherylh001@aol.com">Cherylh001@aol.com</a>
Phone: 302-366-8009      Fax Number: 302-737-7550							
National Xcel Committee Chairman	Claudia	Kretschmer	1342 Darlington Circle	Saline	MI	48176	<a href="mailto:coachcak@mac.com">coachcak@mac.com</a>
Cell Phone: 734-417-1451      Gym/Work Phone: 734-971-1667      Fax Number: 734-971-9631							

**USA GYMNASTICS WOMEN'S PROGRAM OFFICE STAFF**  
**130 E. Washington Street, Suite 700, Indianapolis, IN 46204**  
**317-237-5050 Fax: 317-237-5069**

Position	First Name	Last Name	Email	Cell Phone	Office Phone	Fax Number
Women's Vice President	Annie	Heffernon	<a href="mailto:aheffernon@usagym.org">aheffernon@usagym.org</a>	816-810-2631	317-829-5659	
Women's Junior Olympic Program Director	Christy	Naik	<a href="mailto:cnaik@usagym.org">cnaik@usagym.org</a>	913-378-6263	317-829-5643	
Women's Junior Olympic Technical Director	Connie	Maloney	<a href="mailto:cmaloney@usagym.org">cmaloney@usagym.org</a>	317-281-0795	317-829-5628	
Managing Director of Athlete and Coaching Programs	Kim	Riley	<a href="mailto:kriley@usagym.org">kriley@usagym.org</a>	317-294-0280	317-829-5627	
Women's Program Manager	Krissy	Klein	<a href="mailto:kklein@usagym.org">kklein@usagym.org</a>		317-829-5638	

## REGIONAL AND STATE COMMITTEE OFFICERS

### REGION 1

[www.region-one-gymnastics.com](http://www.region-one-gymnastics.com)

Position	First Name	Last Name	Street Address	City	State	Zip Code	Email	Web Page
<b>RACC:</b>	Evelyn	Paradis	32920 Alvarado Niles Road, #210	Union City	CA	94587	<a href="mailto:evelynparadis1@msn.com">evelynparadis1@msn.com</a>	<a href="http://www.norcalgym.org">www.norcalgym.org</a>
	Work/Gym Phone: 510-471-0240		Cell Phone: 925-963-4627		Fax Number: 510-471-0249			
<b>RTCC:</b>	Gigi	Iavarone	32471 Via Los Santos	San Juan Capistrano	CA	92675	<a href="mailto:Gigi.RTC1@cox.net">Gigi.RTC1@cox.net</a>	
	Cell Phone: 949-573-1654							
<b>RJOCC:</b>	Shane	McIntyre	2401 E. Willow St.	Signal Hill	CA	90755	<a href="mailto:agagymerthane@aol.com">agagymerthane@aol.com</a>	
	Work/Gym Phone: 562-494-0087							
<b>RXCC:</b>	Jill	Preston	440 S. Parkson Road	Henderson	NV	89011	<a href="mailto:jill@gymcats.com">jill@gymcats.com</a>	
	Work/Gym Phone: 702-566-1414		Fax Number: 702-566-1310					
<b>SACC AZ:</b>	Emily	Kelly	2140 S Extension Rd.	Mesa	AZ	85210	<a href="mailto:azsacc@yahoo.com">azsacc@yahoo.com</a>	
	Work/Gym Phone: 480-596-3453		Cell Phone: 480-773-8736					
<b>SACC CA-N:</b>	Patty	Shipman	3444 Country Club Blvd.	Stockton	CA	95204	<a href="mailto:pship@aol.com">pship@aol.com</a>	
			Cell Phone: 209-969-9497		Fax Number:			
<b>SACC CA-S:</b>	Ellie	Gerber	1281 Liberty Way, Suite B	Vista	CA	92081	<a href="mailto:egerberga@gmail.com">egerberga@gmail.com</a>	<a href="http://www.so-calusagymnastics.org">www.so-calusagymnastics.org</a>
	Work/Gym Phone: 760-599-0861		Cell Phone: 760-500-0271		Fax Number: 760-429-7567			
<b>SACC NV:</b>	Cassie	Rice	440 S. Parkson Road	Henderson	NV	89011	<a href="mailto:gymcats@gymcats.com">gymcats@gymcats.com</a>	<a href="http://www.gymcats.com/nevadastate.html">www.gymcats.com/nevadastate.html</a>
	702-566-1414 Work/Gym Phone: ext. 223		Cell Phone: 702-286-2155		Fax Number: 702-566-1310			
<b>SACC UT:</b>	Courtney	Marsh	1387 West 10690 South	South Jordan	UT	84095	<a href="mailto:cmars24@gmail.com">cmars24@gmail.com</a>	<a href="http://www.usagutah.com">www.usagutah.com</a>
	Cell Phone: 801-949-5015							

### REGION 2

[www.usagregion2.com](http://www.usagregion2.com)

Position	First Name	Last Name	Street Address	City	State	Zip Code	Email	Web Page
<b>RACC:</b>	Marian	DeWane	PO Box 2137	Boise	ID	83701	<a href="mailto:r2racc@gmail.com">r2racc@gmail.com</a>	
	Work/Gym Phone: 208-602-5336		Fax Number: 208-342-9124					
<b>RTCC:</b>	Linda	Mulvihill	2230 Monterey	Eugene	OR	97401	<a href="mailto:gymit@aol.com">gymit@aol.com</a>	
	Work/Gym Phone: 541-344-2002		Cell Phone: 541-520-6570					
<b>RJOCC:</b>	Ivan	Alexov	9700 SW Harvest Court, Suite 180	Beaverton	OR	97005	<a href="mailto:alexibg@comcast.net">alexibg@comcast.net</a>	
	Work/Gym Phone: 503-466-4872		Cell Phone: 360-609-1534					
<b>RXCC:</b>	Dianne	Palmer	615 SE High Street	Pullman	WA	99163	<a href="mailto:tenskira@gmail.com">tenskira@gmail.com</a>	
	Cell Phone: 509-432-3389							
<b>SACC AK:</b>	Martha	Dunn	2000 Otter Street	Anchorage	AK	99504	<a href="mailto:Alaska.usagym@gmail.com">Alaska.usagym@gmail.com</a>	<a href="http://www.usagymnasticsalaska.com">www.usagymnasticsalaska.com</a>
	Home Phone: 907-561-3105		Cell Phone: 907-529-8540					
<b>SACC HI:</b>	Pam	Zak	1485 Mele Manu Street	Hilo	HI	96720	<a href="mailto:pamzpe@gmail.com">pamzpe@gmail.com</a>	<a href="http://www.usaghawaii.com">www.usaghawaii.com</a>
	Home Phone: 808-235-6356		Work/Gym Phone: 808-306-7916					
<b>SACC ID:</b>	Mark	Kindelspire	676 W Pullman Road PMB #153	Moscow	ID	83843	<a href="mailto:usagidaho@gmail.com">usagidaho@gmail.com</a>	<a href="http://www.idahogymnastics.com">www.idahogymnastics.com</a>
	Work/Gym Phone: 208-310-6095							
<b>SACC MT:</b>	Josh	Burnham	4 Hitching Post Rd	Bozeman	MT	59715	<a href="mailto:mtusag@gmail.com">mtusag@gmail.com</a>	<a href="http://www.usagmontana.shutterfly.com">www.usagmontana.shutterfly.com</a>
	Work/Gym Phone: 406-581-8557		Cell Phone: 406-581-8557					
<b>SACC OR:</b>	Molly	Gill	1543 SE Gerhard Drive	Hillsboro	OR	97123	<a href="mailto:coachmollygill@gmail.com">coachmollygill@gmail.com</a>	<a href="http://www.usagoregon.com">www.usagoregon.com</a>
	Work/Gym Phone: 503-517-7563		Cell Phone: 503-805-6398		Fax Number: 503-517-2384			
<b>SACC WA:</b>	Susan	Riley	3616 South Rd B3	Mukilteo	WA	98275	<a href="mailto:susriley@hotmail.com">susriley@hotmail.com</a>	<a href="http://www.usagwa.com">www.usagwa.com</a>
			Cell Phone: 206-755-6931		Fax Number:			

**REGION 3**  
[www.reg3.com](http://www.reg3.com)

Position	First Name	Last Name	Street Address	City	State	Zip Code	Email	Web Page
<b>RACC:</b>	Kim	Lauderdale-Stepanek	7270 W. 161st Street	Overland Park	KS	66085	<a href="mailto:klauderdale@diamondacademy.com">klauderdale@diamondacademy.com</a>	
	Work/Gym Phone: 913-851-7500		Cell Phone: 913-219-9135					
<b>RTCC:</b>	Carole	Bunge	11325 Quivas Way	Westminster	CO	80234	<a href="mailto:tcbunge@gmail.com">tcbunge@gmail.com</a>	
	Work/Gym Phone: 303-949-5767							
<b>RJOCC:</b>	Rich	Villarreal	1410 E. 11th Street	Loveland	CO	80537	<a href="mailto:colorich72@gmail.com">colorich72@gmail.com</a>	
	Work/Gym Phone: 970-663-3173		Cell Phone: 970-290-4576					
<b>RXCC:</b>	Louise	Janecky	964 Tsankawi Street	Los Alamos	NM	87544	<a href="mailto:loui.janecky@gmail.com">loui.janecky@gmail.com</a>	
	Work/Gym Phone: 505-662-9523							
<b>SACC AR:</b>	Diane	Garner	25010 Blue Gill	Roland	AR	72135	<a href="mailto:argym02@gmail.com">argym02@gmail.com</a>	<a href="http://www.arusag.org">www.arusag.org</a>
	Cell Phone: 501-416-2614							
<b>SACC CO:</b>	Amanda	Webb	399 Dad Clark Drive	Highlands Ranch	CO	80126	<a href="mailto:awebb@peakathletics.net">awebb@peakathletics.net</a>	<a href="http://www.cousag.com">www.cousag.com</a>
	Work Phone: 303-797-8082							
<b>SACC KS:</b>	Morgan	Uvodich-Kuchynka	7703 Meadow View Dr.	Shawnee	KS	66227	<a href="mailto:morgan.kuchynka@gmail.com">morgan.kuchynka@gmail.com</a>	<a href="http://www.usagymkansas.org">www.usagymkansas.org</a>
	Work/Gym Phone: 913-422-0161		Cell Phone: 913-638-4237					
<b>SACC NM:</b>	Danielle	Postel	3038 Pagosa Meadows Dr. NE	Rio Rancho	NM	87144	<a href="mailto:daniepierre10@aol.com">daniepierre10@aol.com</a>	<a href="http://www.nmusag.com">www.nmusag.com</a>
	Work/Gym Phone: 505-891-0632		Cell Phone: 505-239-9532					
<b>SACC OK:</b>	Karis	Alford	3251 Market Place Suite 120	Norman	OK	73072	<a href="mailto:usag.okstatechair@gmail.com">usag.okstatechair@gmail.com</a>	<a href="http://www.okusag.com">www.okusag.com</a>
	Work/Gym Phone: 405-329-7827		Cell Phone: 580-618-2108		Fax Number:			
<b>SACC TX:</b>	Debbie	Williams	1205 Schumac Lane	Bedford	TX	76022	<a href="mailto:deborahdwilli@gmail.com">deborahdwilli@gmail.com</a>	<a href="http://www.txusag.com">www.txusag.com</a>
	Home Phone: 817-540-1619		Cell Phone: 817-233-4721		Fax Number: 682-292-2948			
<b>SACC WY:</b>	Christi	Hawkins	1212 E. 24th Street	Cheyenne	WY	82001	<a href="mailto:usagwy@gmail.com">usagwy@gmail.com</a>	<a href="http://www.wyousag.com">www.wyousag.com</a>
	Work/Gym Phone:		Cell Phone: 307-630-9206					

**REGION 4**  
[www.region4gymnastics.com](http://www.region4gymnastics.com)

Position	First Name	Last Name	Street Address	City	State	Zip Code	Email	Web Page
<b>RACC:</b>	Rick	Nelson	573 W17240 Lake Drive	Muskego	WI	53150	<a href="mailto:Rick@midwesttwisters.com">Rick@midwesttwisters.com</a>	
	Work/Gym Phone:		Cell Phone: 414-698-6257		Fax Number:			
<b>RTCC:</b>	Linda	Thorberg	20525 Hartford Way	Lakeville	MN	55044	<a href="mailto:linda4rtc@aol.com">linda4rtc@aol.com</a>	
			Cell Phone: 952-200-9514		Fax Number:			
<b>RJOCC:</b>	Paige	Roth	2550 Holiday Road	Coralville	IA	52241	<a href="mailto:paiger@iowagymnest.com">paiger@iowagymnest.com</a>	
			Cell Phone: 319-530-5317		Fax Number: 319-887-1136			
<b>RXCC:</b>	Megan	Robinson	609 Reed Court	West Des Moines	IA	50266	<a href="mailto:region4xcel@gmail.com">region4xcel@gmail.com</a>	
	Work /Gym Phone: 515-276-2027		Cell Phone: 515-669-6556					
<b>SACC IA:</b>	Todd	Beyer	2906 C Avenue NE	Cedar Rapids	IA	52402	<a href="mailto:btltmt@mchsi.com">btltmt@mchsi.com</a>	<a href="http://www.lowausag.com">www.lowausag.com</a>
	Work/Gym Phone: 319-389-3704		Cell Phone: 319-389-3704					
<b>SACC MN:</b>	Ryan	Rohloff	5555 Pioneer Creek Drive	Maple Plain	MN	55359	<a href="mailto:ryan@northshoregym.org">ryan@northshoregym.org</a>	<a href="http://www.mnusag.com">www.mnusag.com</a>
	Work/Gym Phone: 763-479-3189							
<b>SACC MO:</b>	Kathy	Sanford	3881 W. Red Rock Road	Columbia	MO	65202	<a href="mailto:gvmkatsan@aol.com">gvmkatsan@aol.com</a>	<a href="http://www.mousag.org">www.mousag.org</a>
	Work/Gym Phone: 573-443-3547							
<b>SACC NE:</b>	Carol	Balerud	3625 35th Street	Columbus	NE	68601	<a href="mailto:cbalerud@gmail.com">cbalerud@gmail.com</a>	<a href="http://www.neusag.wordpress.com">www.neusag.wordpress.com</a>
	Work/Gym Phone: 402-563-5146							
<b>SACC ND:</b>	Whitney	Beck	2001 17th Ave S	Fargo	ND	58103	<a href="mailto:whitney@americangoldgymnastics.com">whitney@americangoldgymnastics.com</a>	<a href="http://www.ndusag.wordpress.com">www.ndusag.wordpress.com</a>
	Work/Gym Phone: 701-280-0400							
<b>SACC SD:</b>	Audra	Rew	515 E. 6th Ave.	Mitchell	SD	57301	<a href="mailto:Audra.rew@gmail.com">Audra.rew@gmail.com</a>	<a href="http://www.sdusagymnastics.com">www.sdusagymnastics.com</a>
	Cell Phone: (605) 770-8454							
<b>SACC WI:</b>	Randy	Anderson	5711 77th Street	Kenosha	WI	53142	<a href="mailto:scampsgymnastics@aol.com">scampsgymnastics@aol.com</a>	<a href="http://www.usagymwi.com">www.usagymwi.com</a>
	Work/Gym Phone: 262-694-0805		Cell Phone: 262-945-1884					



## REGION 5

[www.Region5.com](http://www.Region5.com)

Position	First Name	Last Name	Street Address	City	State	Zip Code	Email	Web Page
RACC:	Dave	Stiles	105 Woodland Lane	Carmel	IN	46032	<a href="mailto:d.b.stiles@att.net">d.b.stiles@att.net</a>	
			Cell Phone: 317-504-8281					
RTCC:	Char	Christensen	1260 Churchbell Way	Columbus	OH	43235	<a href="mailto:charchristensen@icloud.com">charchristensen@icloud.com</a>	
	Work/Gym Phone: 614-668-8822							
RJOCC:	Kittia	Carpenter	566 Mulberry Way N	Westerville	OH	43082	<a href="mailto:kittiac@buckeyegymnastics.com">kittiac@buckeyegymnastics.com</a>	
	Work/Gym Phone: 614-895-1611		Cell Phone: 614-309-0858		Fax Number: 614-895-7644			
RXCC:	Nancy	Gibson	1344 Lockard Street	Madison	IN	47250	<a href="mailto:judgen1@aol.com">judgen1@aol.com</a>	
	Cell Phone: 219-781-3088							
SACC IL:	Norbert	Bendixen	426 Midway	Mundelein	IL	60060	<a href="mailto:Norbertil@aol.com">Norbertil@aol.com</a>	<a href="http://www.ilusagymnastics.com">www.ilusagymnastics.com</a>
	Work/Gym Phone: 847-334-7768		Fax Number: 309-444-3209					
SACC IN:	Bob	Neat	2709 S 500 W	New Palestine	IN	46163	<a href="mailto:robertneat@aol.com">robertneat@aol.com</a>	<a href="http://www.indianausagym.org">www.indianausagym.org</a>
	Work/Gym Phone:		Cell Phone: 317-332-1968		Fax Number:			
SACC KY:	Brian	Blewitt	2388 New Haven Road	Bardstown	KY	40004	<a href="mailto:brianblewitt@blueribbonssports.net">brianblewitt@blueribbonssports.net</a>	<a href="http://www.usagymkentucky.com">www.usagymkentucky.com</a>
	Work/Gym Phone: 502-348-2164		Cell Phone: 502-419-0212					
SACC MI:	Becky	Burden-Cuddeback	971 Lynch Drive	Traverse City	MI	49686	<a href="mailto:beckyburd@gmail.com">beckyburd@gmail.com</a>	<a href="http://www.michiganagymnastics.com">www.michiganagymnastics.com</a>
	Work/Gym Phone: 231-941-7751		Cell Phone: 231-649-2813					
SACC OH:	Patrick	Jordan	836 Reading Road	Mason	OH	45040	<a href="mailto:patrickjordan@gym-nation.com">patrickjordan@gym-nation.com</a>	<a href="http://www.ohiousagym.org">www.ohiousagym.org</a>
	Work/Gym Phone: 513-229-7315		Cell Phone: 513-383-9782					

## REGION 6

[www.region6usagym.org](http://www.region6usagym.org)

Position	First Name	Last Name	Street Address	City	State	Zip Code	Email	Web Page
RACC:	Kathy	Ostberg	365 Spring Street	Shrewsbury	MA	01545	<a href="mailto:region6usag@gmail.com">region6usag@gmail.com</a>	<a href="http://www.region6usagym.org">www.region6usagym.org</a>
	Phone: 508-735-3149							
RTCC:	Pat	Panichas	9 Sherman Lane	Hamden	CT	06514	<a href="mailto:panichas@aol.com">panichas@aol.com</a>	
	Work/Gym Phone: 203-392-6082		Fax Number: 203-392-6093					
RJOCC:	Jamie	Winkler	6 Forest Ridge Drive	Nyack	NY	10960	<a href="mailto:region6jamie@gmail.com">region6jamie@gmail.com</a>	
	Work/Gym Phone: 845-398-1000		Cell Phone: 914-837-9136		Fax: 845-398-1009			
RXCC:	Gail	Caspere	27 Taconic Road	Millwood	NY	10546	<a href="mailto:gailregion6xcel@gmail.com">gailregion6xcel@gmail.com</a>	
	Cell Phone: 914-837-0788							
SACC CT:	Laurie	DeFrancesco	25 Congress Avenue	Shelton	CT	06484	<a href="mailto:ldfusagct@aol.com">ldfusagct@aol.com</a>	<a href="http://www.ctusagym.org">www.ctusagym.org</a>
	Home Phone: 203-924-9257		Cell Phone: 203-231-4967		Fax Number: 203-977-7898			
SACC ME:	Carol	Brewer	822 Middle Road	Skowhegan	ME	04976	<a href="mailto:decalgym.carol@gmail.com">decalgym.carol@gmail.com</a>	<a href="http://www.maineagymnastics.org">www.maineagymnastics.org</a>
	Work/Gym Phone: 207-474-3222		Cell Phone: 207-399-7444					
SACC MA:	Michele	Archer	PO Box 294	Ashburnham	MA	01430	<a href="mailto:michele.archer@aol.com">michele.archer@aol.com</a>	<a href="http://www.mausagym.com">www.mausagym.com</a>
	Cell Phone: 978-866-0439							
SACC NH:	Seana	Rioux	112 Crawley Falls Road	Brentwood	NH	03833	<a href="mailto:nhusag@comcast.net">nhusag@comcast.net</a>	<a href="http://www.nhusagym.org">www.nhusagym.org</a>
	Work/Gym Phone: 603-642-7200		Cell Phone: 603-770-6199					
SACC NY:	Tina	Ferriola	480 Greenwich Street	New York	NY	10013	<a href="mailto:usagny@gmail.com">usagny@gmail.com</a>	<a href="http://www.nyusag.com">www.nyusag.com</a>
			Cell Phone: 917-549-6934		Fax Number: 212-334-1179			
SACC RI:	Kelli	Doorley	64 Scapa Flow Rd.	Charlestown	RI	02813	<a href="mailto:riwstatchair@gmail.com">riwstatchair@gmail.com</a>	<a href="http://www.riusagym.com">www.riusagym.com</a>
	Work/Gym Phone: 401-213-6645		Fax Number: 401-213-6645					
SACC VT:	Jill	Vanderpot	94 Olcott Drive	White River Jct	VT	05001	<a href="mailto:jillnjg@yahoo.com">jillnjg@yahoo.com</a>	<a href="http://www.vermontgymnastics.com">www.vermontgymnastics.com</a>
	Work/Gym Phone: 802-295-2070		Cell Phone: 603-252-6075					

## REGION 7

[www.Region7usagym.com](http://www.Region7usagym.com), [www.facebook.com/Region7Gymnastics](http://www.facebook.com/Region7Gymnastics)

Position	First Name	Last Name	Street Address	City	State	Zip Code	Email	Web Page
RACC:	Jen	Bortz	PO Box 243 Cell Phone: 814-380-1195	Boalsburg	PA	16827	<a href="mailto:jbortz7rac@gmail.com">jbortz7rac@gmail.com</a>	<a href="http://www.Region7usagym.com">www.Region7usagym.com</a>
RTCC:	Myra	Elfenbein	10/1-5/31: 8806 Church Field Lane 6/1-9/30: 7711 NE 175th St. Unit E-104 Cell Phone: 240-593-1618	Laurel	MD	20708	<a href="mailto:region7rtc@comcast.net">region7rtc@comcast.net</a>	
RJOCC:	Linda	Johnson	2456 Vineyard Lane Cell Phone: 443-569-9412	Crofton	MD	21114	<a href="mailto:r7jocc@gmail.com">r7jocc@gmail.com</a>	
RXCC:	Jane	Caruso	9 Chestnut Drive Home Phone: 215-860-5130 Cell Phone: 267-229-9022	Newtown	PA	18940	<a href="mailto:janecaruso2@gmail.com">janecaruso2@gmail.com</a>	
SACC DE:	Cleo	Washington	131 John F Campbell Rd. Work/Gym Phone: 302-368-7107 Cell Phone: 302-250-1550	Newark	DE	19711	<a href="mailto:usag_de@gmail.com">usag_de@gmail.com</a>	
SACC MD:	Beth	Renwick	3309 Abell Avenue Cell Phone: 410-591-7898	Baltimore	MD	21218	<a href="mailto:bethrenwick@aol.com">bethrenwick@aol.com</a>	<a href="http://www.mdusagym.com">www.mdusagym.com</a>
SACC NJ:	Brant	Lutska	92 State Street Work/Gym Phone: 724-469-0410	Perth Amboy	NJ	08861	<a href="mailto:saccnj@gmail.com">saccnj@gmail.com</a>	<a href="http://www.usagnj.com">www.usagnj.com</a>
SACC PA:	Donna	Guenther	155 Philmont Avenue Gym Phone: 215-364-7878	Feasterville	PA	19053	<a href="mailto:Pausag155@gmail.com">Pausag155@gmail.com</a>	<a href="http://www.pagymnastics.com">www.pagymnastics.com</a>
SACC VA:	Steve	Garman	3116 Knoll Drive Cell Phone: 703-217-9575	Falls Church	VA	22042	<a href="mailto:vausag@gmail.com">vausag@gmail.com</a>	<a href="http://www.vausag.com">www.vausag.com</a>
SACC WV:	Adam	Bowman	420 Skyline Drive Cell Phone: 304-553-1626	Charleston	WV	25302	<a href="mailto:wvusag@gmail.com">wvusag@gmail.com</a>	<a href="http://www.wvusag.com">www.wvusag.com</a>

## REGION 8

[www.region8gymnastics.org](http://www.region8gymnastics.org)

Position	First Name	Last Name	Street Address	City	State	Zip Code	Email	Web Page
RACC:	Debby	Kornegay	394 Stonebridge Road USA Gym Phone: 205-951-0184 Cell Phone: 205-903-8149 Fax Number:	Birmingham	AL	35210-4111	<a href="mailto:debgk@me.com">debgk@me.com</a>	
RTCC:	Marian	Dykes	4651 Buford Highway Work/Gym Phone: 770-451-6910 Cell Phone: 404-408-6699 Fax Number: 770-457-0943	Atlanta	GA	30341-3714	<a href="mailto:marandykes@aol.com">marandykes@aol.com</a>	
RJOCC:	Brad	Harris	2301 26th Street N Work/Gym Phone: 727-328-8500 Cell Phone: 727-510-1903 Fax Number: 727-328-8522	St. Petersburg	FL	33713	<a href="mailto:Tbayturnrs@aol.com">Tbayturnrs@aol.com</a>	
RXCC:	Elaine	Wulf	1301 Hillbrow Lane, Apt. 304 Cell Phone: 919-610-4021	Raleigh	NC	27615	<a href="mailto:ewomaha@aol.com">ewomaha@aol.com</a>	
SACC AL:	Michael	Holdefer	720 14th Street Work/Gym Phone: 205-759-9359 Cell Phone: 205-394-1384 Fax Number: 205-406-8690	Tuscaloosa	AL	35401	<a href="mailto:mholdefer@gmail.com">mholdefer@gmail.com</a>	<a href="http://www.alausagym.com">www.alausagym.com</a>
SACC FL:	Toni	Rand	7957 Steeplechase Court Home Phone: 772-489-5982	Port St. Lucie	FL	34986	<a href="mailto:AmTwist@aol.com">AmTwist@aol.com</a>	<a href="http://www.usagfl.org">www.usagfl.org</a>
SACC GA:	Michelle	Pomerantz	2620 Spring Bluff Court Work/Gym Phone: 678-546-6626 Cell Phone: 404-663-1096	Buford	GA	30519	<a href="mailto:mhpomerantz@gmail.com">mhpomerantz@gmail.com</a>	<a href="http://www.gausag.org">www.gausag.org</a>
SACC LA:	Jackie	Latino	4170 Barataria Blvd Work/Gym Phone: 504-328-3838 Cell Phone: 504-881-3138	Marrero	LA	70072	<a href="mailto:latinojackie@aol.com">latinojackie@aol.com</a>	<a href="http://www.LAUSAG.com">www.LAUSAG.com</a>
SACC MS:	Cynthia	Dedeaux	21271 Lawrence Ladner Road Cell Phone: 228-493-8514	Kiln	MS	39556	<a href="mailto:Cynthiadedeaux4@gmail.com">Cynthiadedeaux4@gmail.com</a>	<a href="http://www.mmysusag.org">www.mmysusag.org</a>
SACC NC:	Jennie	Kennel Adams	86 Rollo Road, Kennel's Beach Cell Phone: 252-514-5870	Grantsboro	NC	28529	<a href="mailto:NCUSAGymnastics@gmail.com">NCUSAGymnastics@gmail.com</a> <a href="mailto:jenniekadams@gmail.com">jenniekadams@gmail.com</a>	<a href="http://www.nc-usagymnastics.org">www.nc-usagymnastics.org</a>
SACC SC:	Joanne	Child	209 Hickory Knoll Drive Work/Gym Phone: 803-788-2808 Cell Phone: 803-315-7561 Fax Number: 803-788-2911	Columbia	SC	29203	<a href="mailto:jchildscgym@bellsouth.net">jchildscgym@bellsouth.net</a>	<a href="http://www.sc-gymnastics.org">www.sc-gymnastics.org</a>
SACC TN:	Larry	Corrigan	2231-H Madison Street Work/Gym Phone: 931-906-1663	Clarksville	TN	37043	<a href="mailto:CegcCoach1@cs.com">CegcCoach1@cs.com</a>	<a href="http://www.tnusag.org">www.tnusag.org</a>

## LIASONS TO NATIONAL WOMEN'S PROGRAM COMMITTEE

Board of Directors Representative: Kittia Carpenter  
Program Council Members: Kittia Carpenter

## National Association of Women's Gymnastics Judge's (NAWGJ)

President: Evelyn Chandler  
[presnawgj@aol.com](mailto:presnawgj@aol.com)  
Phone: 407-656-7222  
Cell Phone: 321-217-2347

## NCAA Eligibility-Legislative Services

1802 Alonzo Watford Sr. Dr.  
Indianapolis, IN 46202  
317-917-NCAA  
Hotline: 1-800-638-3731

## Judges Accreditation

Connie Maloney  
[cmaloney@usagym.org](mailto:cmaloney@usagym.org)  
317-829-5628

## US Elite Coaches Accociation (USECA)

[www.useca.org](http://www.useca.org)  
[mquzman@useca.us](mailto:mquzman@useca.us)  
925-238-0316

## USA GYMNASTICS NATIONAL OFFICE

130 E. Washington Street, Suite 700  
Indianapolis, IN. 46204  
317-237-5050  
Fax: 317-237-5069  
[www.usagym.org](http://www.usagym.org)

## Member Services

Member Services: 1-800-345-4719 Fax: 317-692-5212  
Chief Membership Officer: Erica Koven. Email: [ekoven@usagym.org](mailto:ekoven@usagym.org)

**"The HOT LINE"**

Should questions arise, members should seek answers by following the "chain of command" described below:

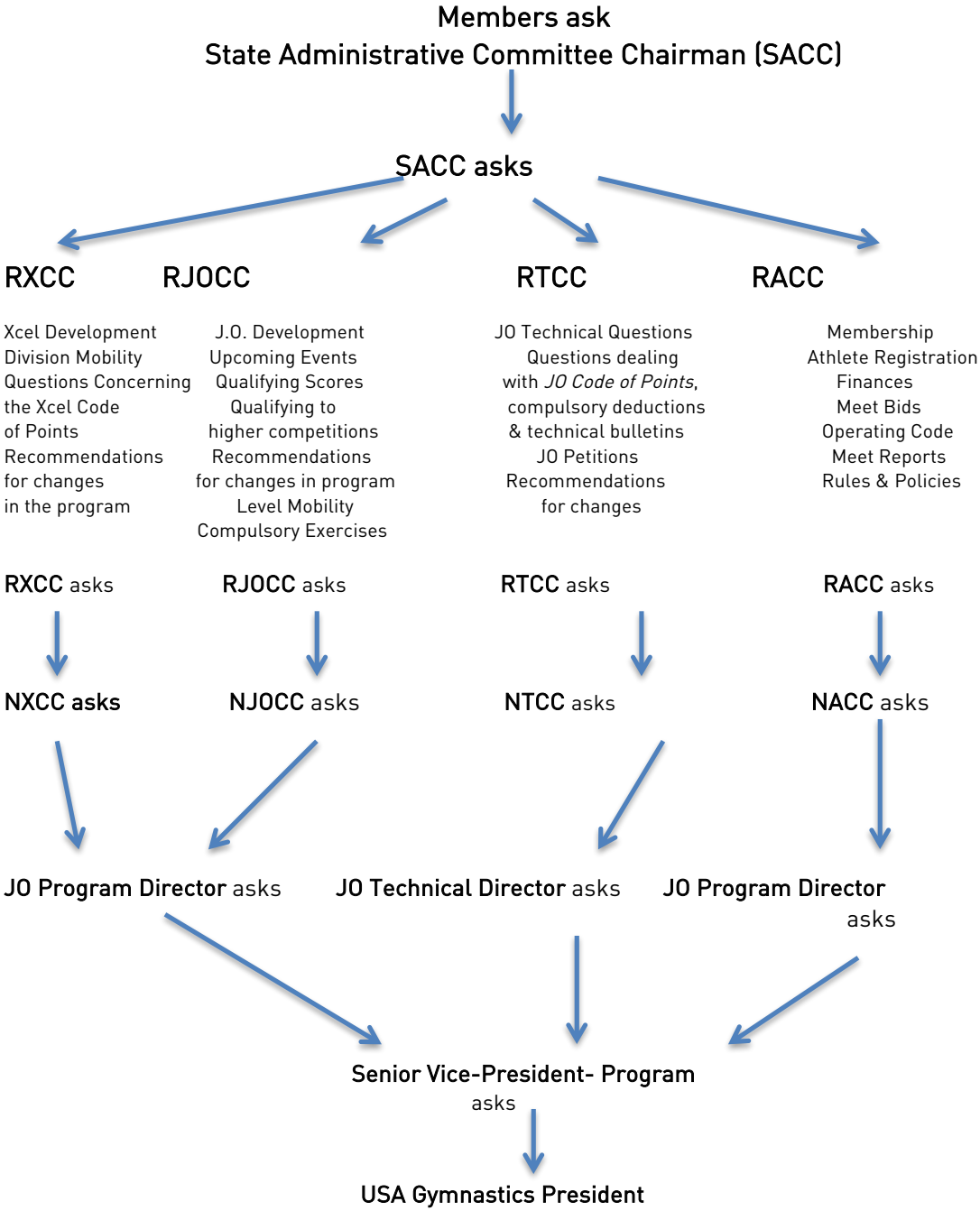

INTERPRETATION OF THE *RULES & POLICIES* IS THE RESPONSIBILITY OF THE  
WOMEN'S PROGRAM COMMITTEE & THE PRESIDENT OF USA GYMNASTICS

# USA Gymnastics Women's Program Committee Regions

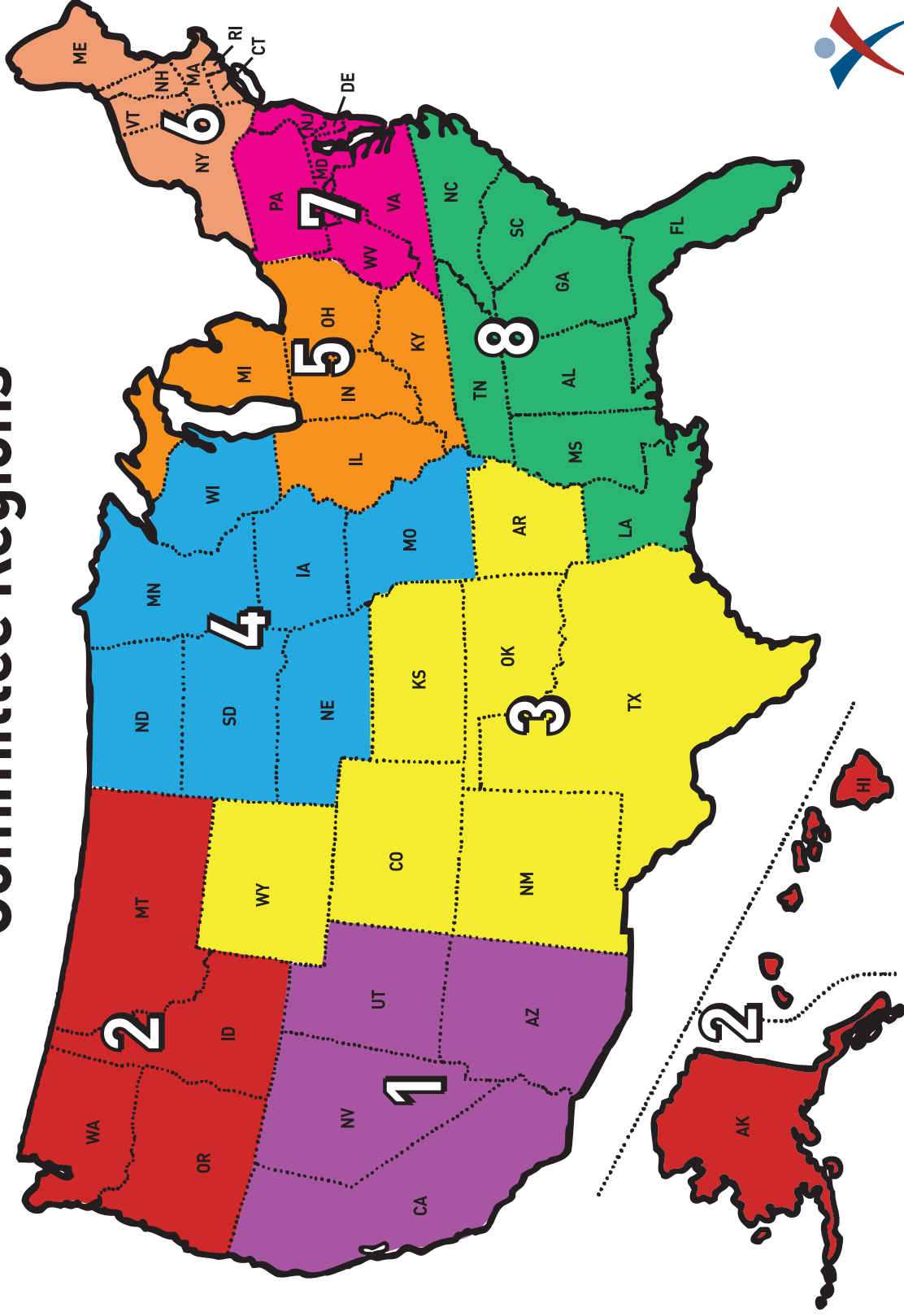

USA GYMNASTICS®

# USA Gymnastics Purpose and Code of Ethical Conduct

The purpose of the National Women's Program of USA Gymnastics is to promote, serve, and administer the official gymnastics program for girls and women of all levels of ability throughout the United States. This shall be done by:

- A. Carrying out the purposes and objectives of USA Gymnastics.
- B. Providing for the expansion and improvement of gymnastics programs through the training and certification of judges and the education of qualified instructors to conduct appropriate gymnastics programs.
- C. Organizing competitions for girls and women of all ability at local, state, regional, and national events.
- D. Providing for the technical organization and development of specific guidelines, rules and policies, and providing a network of communication necessary for the implementation of these objectives.

Interpretation of this publication is the expressed duty and responsibility of the Women's Program Committee and the President of USA Gymnastics.

## USA Gymnastics Code of Ethical Conduct

Members of USA Gymnastics have an ongoing, affirmative duty to promote a culture that empowers and supports athletes and focuses on USA Gymnastics' highest priority: the safety and well-being of our athletes. Every member of USA Gymnastics is responsible for ensuring an environment that makes participation in the sport a positive and rewarding experience. The USA Gymnastics Code of Ethical Conduct (the "Code") is intended to work in conjunction with the *USA Gymnastics Safe Sport Policy*, and as such sets forth USA Gymnastics and its members' commitment to act ethically in all instances. Further the Code is intended to provide guidance in situations that have potential or actual ethical implications. The effectiveness of the Code depends on a personal commitment from every member of the gymnastics community. It is expected that all Members of USA Gymnastics will implement and adhere to the Code.

This Code is divided into two sections: (1) Ethical Obligations; and (2) Resolution of Ethical Issues. The Code does not address misconduct or abusive behaviors. Instead, the *USA Gymnastics Safe Sport Policy* provides the definitions and mandatory reporting requirements for misconduct and abuse.

### I. Ethical Obligations

#### A. Promotion of a Safe, Positive and Healthy Environment.

Members have an ongoing obligation and commitment to ensure a safe and healthy environment for all gymnastics participants. Consistent with this obligation, members must:

- Make decisions in the best interest of athletes.
- Maintain a safe training and competing environment.
- Promote a culture of trust and empowerment.
- Respect the fundamental rights, dignity, and worth of all participants.
- Encourage a healthy lifestyle and support nutritional well-being.
- Promote and respect all Safe Sport principles.

#### B. Commitment to Integrity.

Members have a responsibility to uphold the integrity of the sport and to act honestly, openly, fairly, and competently. Members must:

- Be knowledgeable of, understand, and follow USA Gymnastics rules and policies, and refrain from knowingly misrepresenting or misinterpreting such.
- Promote fair play.
- Maintain respect on the floor and refrain from intimidating, embarrassing or improperly influencing any individual responsible for participating in, judging, or administering a competition.
- Follow the established procedures for challenging a competitive result.
- Make honest certifications regarding compliance with USA Gymnastics' policies, procedures or membership requirements.
- Avoid engaging in business practices directed toward another Member that are known to be or are determined by a court or similar adjudicatory body to be, unethical, illegal or a breach of contract.

**C. Participation and Inclusion.**

Members have the right to participate in any USA Gymnastics activity or event for which the Member is properly qualified under the rules of that activity or event and may participate to the best of his/her abilities at his/her discretion:

- Members may not knowingly participate in, or cause others to participate in, any activity or event where that individual is inadequately prepared or unable to participate safely.
- Members must promote positive participation and avoid behavior that is likely to interfere with the orderly conduct of the activity or other Members' participation in, or enjoyment of, an activity or event.
- Members must respect the rights and opinions of others.
- Members must facilitate cooperation in order to serve athletes and other participants effectively and appropriately.
- Members must promote inclusion and an environment free of discrimination. Members may not:
  - Restrict the ability of a Member to qualify for or participate in competition because of the Member's association with a particular organization or individual or because of that Member's race, sex, creed, sexual orientation, age, national origin, mental or physical disability, or any other basis proscribed by law.
  - Discriminate in the allocation of resources or opportunities to any Member or prospective Member on the basis of race, sex, creed, sexual orientation, age, national origin, mental or physical disability, or any other basis proscribed by law.

**D. Communication.**

Members of USA Gymnastics have a duty to communicate honestly and openly and must:

- Strive to promote the sport and athletes in a positive manner.
- Provide all information and resources necessary to enhance a gymnast's enjoyment of the sport or reduce their risk of injury or illness.
- Refrain from unsportsmanlike comments or behavior.
- Address differences in a calm and respectful manner.
- Clearly communicate roles, responsibilities and expectations.
- Avoid making false or misleading claims; or, falsify, or omit any information, record or document or other evidence for any purpose.
- Accurately represent competitive achievements, professional qualifications, education, experience, eligibility, criminal record and other misconduct, and/or affiliations.

**E. Concern for the Welfare of Others.**

Members shall seek to contribute to the welfare of gymnastics participants and must:

- Promote a culture of empowerment with a focus on athlete health and safety.
- Comply with mandatory reporting requirements established by federal law, the U.S. Center for SafeSport and USA Gymnastics Safe Sport Policy.
- Proactively address potentially harmful behavior or an unsafe environment.
- Be sensitive to any imbalance of power.
- Resolve conflicts in a professional manner.

**F. Professional Responsibility.**

Members have the responsibility to aspire to the highest possible standards of conduct and must:

- Prioritize athlete welfare.
- Faithfully complete USA Gymnastics membership requirements.
- Strive to maintain high standards and excellence.
- Seek to increase proficiency levels through continuing education and in consultation with other professionals.
- Participation only at a level of the sport in which an individual is qualified and prepared for.
- Accept appropriate responsibility for one's own behavior and report any unlawful or other inappropriate conduct of others in accordance with Section II below.

**G. Alcohol and Drug Free Environment.**

Members of USA Gymnastics must ensure that the sport is conducted in an environment free of drug or alcohol abuse.

Members may not:

- Use or provide to a third party any illegal (scheduled) drug pursuant to applicable federal, state or municipal law.
- Assist or condone any competing athlete's use of a drug banned by any applicable governing body, or, in the case of athletes, to use such drugs or refuse to submit to properly conducted drug tests administered by any governing body.
- Provide alcohol to or condone the use of alcohol by minors; consume alcohol while engaging in USA Gymnastics activities, including coaching and/or training and/or competing; consume excessive alcohol in the presence of athletes or at USA Gymnastics' events; or consume alcoholic beverages while a minor.

## II. Resolving Ethical Issues

Members of USA Gymnastics have an obligation to be familiar with the principles outlined within this Code. The methods for reporting and resolution of possible ethical violations is outlined below. Members must cooperate fully with any and all undertakings in the review and resolution of a potential ethical violation.

### A. Informal Resolution of Ethical Violations.

When a Member believes that another Member has committed an ethical violation, they may attempt to resolve the issue by bringing it to the attention of that individual if an informal resolution appears appropriate and when intervention does not violate any athlete rights that may be involved. If such information resolution does not resolve matters, the Member should report such ethical violation in accordance with the below.

### B. Reporting Possible Ethical Violations.

1. If an apparent ethical violation is not appropriate for informal resolution or is not resolved properly in that fashion, a Member may file a complaint with USA Gymnastics via any of USA Gymnastics' reporting avenues, including:
  - Email: [safesport@usagym.org](mailto:safesport@usagym.org)
  - Hotline: (833) 844-SAFE
  - Online: <https://usagym.org/pages/education/safesport/report.html>
2. Complaints must describe the nature of the alleged ethical violation, identify the aggrieved party and the individual(s) believed to be responsible for the violation, and the desired resolution. While confidentiality will be maintained where possible, in no case will confidentiality preclude the reporting of a violation as required by state or federal law.
3. Parents, on behalf of their minor child, are encouraged to file reports on behalf of their son or daughter, in situations where they believe a Member of USA Gymnastics has committed an ethical violation.

### C. Resolution of Complaints.

1. Review.

Upon timely review and consideration of a complaint alleging an ethical violation, USA Gymnastics may:

  - a. Determine that the complaint does not merit further action after review of all material facts and opportunity for informal inquiry.
  - b. Refer the complaint for an alternate resolution path:
    - *U.S. Center for SafeSport.* If the review of a complaint gives rise to facts and circumstances that are within the exclusive jurisdiction of the U.S. Center for SafeSport, USA Gymnastics will notify the Center, and transfer the matter to the Center for resolution.
    - *Articles 9 and 10 of USA Gymnastics Bylaws.* If the review of a complaint gives rise to facts and circumstances that are more appropriate for investigation and adjudication by the process described in Articles 9 and 10 of its Bylaws, USA Gymnastics will process the complaint pursuant to those procedures.
    - *Other referrals.* If the review of a complaint gives rise to facts and circumstances that are more appropriate for resolution elsewhere, USA Gymnastics will refer the complaint, as appropriate, to a state or regional chair, committee or affiliated organization.
  - c. If the complaint has not been dismissed or otherwise referred, then:
    - Notice will be provided to both parties who will be given an opportunity to respond and/or provide supporting information, and
    - Where appropriate, additional discussions with the parties or other individuals who may have relevant information will take place, and
    - If necessary, additional due diligence will be conducted which may include additional research or collection of documents, review of a member record, or any other actions that can be reasonably undertaken to assess the situation.
2. Resolution
  - a. USA Gymnastics' standard of proof in determining whether an ethical violation has occurred is "more likely to have occurred than not". Based upon careful review of all the available information, an individual will be found responsible for an ethical violation if it can be reasonably concluded that the violation more likely than not occurred.
  - b. USA Gymnastics will err on the side of protecting the safety and well-being of gymnasts.
  - c. Lack of awareness or misunderstanding of an ethical standard is not itself a defense to an allegation of unethical conduct.



## Introduction

- d. Based on a careful review of the complaint and information obtained during the review process, USA Gymnastics may:
- Inform the parties that based upon the review there was no finding of an ethical violation, or
  - Inform the parties that based upon the review there is a finding of an ethical violation; and counsel the members, as appropriate, or impose an appropriate sanction or an appropriate relief.
  - Report to law enforcement where required by state or federal law.
- e. *Sanction Guidelines.* Sanctions for ethical violations shall apply equally to all members based on an evaluation of the violation regardless of gender, competitive/coaching/judging level, achievements within the sport, or other factors not directly related to the violation. Sanctions will be reasonable and proportionate to the violation and surrounding circumstances, consistent with sanctions issued for similar violations and designed to promote participant welfare. General considerations when imposing sanctions include:
- Nature and severity of the violation
  - Ages of the individuals involved
  - Member record and pattern of behavior
  - Voluntary disclosure of the violation, cooperation, or demonstration of remorse
  - Disposition by law enforcement
  - Perceived or real impact on the concerned parties
  - Likelihood of rehabilitation
  - Ability to affect positive change
- f. *Types of Sanctions.* Disciplinary sanctions include a wide range of options that range in severity (note: this is not an all-inclusive list, but rather, common forms of sanctions).
- *Warning.* A warning letter - either public or private - will detail the specific violation and/or action or inaction that led to the finding of the misconduct or violation, as well as the future behavior expectations.
  - *Removal from sanctioned activity.* Either for a specific event, series of events, or period of time.
  - *Warning with recommendation.* i.e., a mandate to review or implement a specific policy or behavior.
  - *Educational remedy.* Mandate to take an educational course or demonstrate compliance with USA Gymnastics' or a Member Club's policy.
  - *Interim Measures.* Imposing restrictions or requirements such as amended training schedules, supervised interactions, contact limitations, and may also include Probation or Suspension.
  - *Probation.* A period of time whereby the individual's behavior will be monitored, and generally includes restrictions on membership privileges.
  - *Suspension.* A period of time whereby the individual does not have any of the rights and privileges associated with membership, including the right to be involved in a Member Club's activities or participate in USA Gymnastics' sanctioned activities. The suspension notification will detail the criteria by which the suspension will be reviewed, lifted, or converted to an alternate sanction.
  - *Revocation of Member Club Status.* A club whose membership in USA Gymnastics has been terminated and therefore may no longer host USA Gymnastics sanctioned events or register/compete a team of athletes in USA Gymnastics sanctioned competitions.
  - *Permanently Ineligible for Membership.* An individual whose membership in USA Gymnastics has been terminated for life and who may no longer be affiliated with a USA Gymnastics Member Club or participate in USA Gymnastics' sanctioned activities.
  - *Membership Ineligibility.* An individual deemed ineligible to obtain membership in USA Gymnastics, such as an individual involved in the sport who has never been a member of USA Gymnastics or a Covered Individual, nor applied for membership.
  - *Other Relief.* Relief deemed appropriate to the violations and/or circumstances of the matter, for example, an apology or restitution.

## Part II. USA Gymnastics' Safe Sport Measures

### A. Criminal Background Screening of Individual Members

As a condition to being granted the privilege of membership in USA Gymnastics, individuals applying for professional membership must submit to criminal background screening pursuant to USA Gymnastics' Criminal Background Screening Policy. Individuals given a "Green Light" or "meets the screening criteria" consistent with that policy fulfill the background-screening requirement for membership in USA Gymnastics. Individuals given a "Red Light" consistent with that policy means criminal history has been sourced that "does not meet the screening criteria."

USA Gymnastics will continually monitor and review the individuals who are subject to criminal background searches, with the primary goal of safeguarding gymnasts and other participants through proactive measures while conforming to legal norms and industry best practices.

### B. Permanently Ineligible for Membership List

USA Gymnastics maintains a list of individuals and clubs who are permanently ineligible for membership, available at [usagym.org/ineligible](http://usagym.org/ineligible). Persons and clubs who are sanctioned with a lifetime ban are restricted from involvement or association with USA Gymnastics and Member Club activities. Professional members who knowingly employs or associates with an ineligible member will be subject to termination of their membership.

### C. Code of Ethical Conduct

The Code provides guidance and affirms the commitment of all members to safeguard the best interests of the sport and its athletes by acting ethically at all times.

### D. Athlete Member Advisement

Upon obtaining membership in USA Gymnastics, an enclosure is mailed with the Athlete Membership Card advising Athletes of the organization's initiatives to promote a safe environment including awareness of this Safe Sport Policy, his/her role in maintaining the Athlete's own safety, and available safe sport resources.

### E. Professional Member Advisement

Upon obtaining membership in USA Gymnastics, an enclosure is mailed with the Professional Membership Card advising the member of the organization's initiatives to promote a safe environment for gymnasts and other participants including awareness of this Safe Sport Policy, the member's obligation's in maintaining a safe environment, and available safe sport resources.

### F. Member Clubs

As a condition for the privilege of membership in USA Gymnastics as a Member Club, a club must agree to and comply with the following requirements for the entirety of the club's membership period, and a certification of compliance must be made annually.

1. Have a policy consistent with USA Gymnastics' Safe Sport Policy that affirms the club's commitment to the welfare of gymnastics participants in its club and includes, at minimum, a description of conduct that will not be tolerated, standards of behavior that promote participant welfare, and a process for receiving and handling complaints regarding conduct that violates its policy.
2. Must adopt USA Gymnastics "Prevention Policies" into the club's policies and be able to provide written documentation of compliance.
3. Certify that no persons permanently ineligible for USA Gymnastics membership and no persons listed on a federal or state sex-offender registry are or will be associated with the club or its activities in any way.
4. Maintain current commercial general liability insurance that includes at a minimum, participant liability and participant accident medical insurances.
5. Maintain a current Professional membership for the owner of a private gymnastics facility and/or the managing director of a public/non-profit facility.
6. Have a mission statement consistent with USA Gymnastics' mission to encourage participation and the pursuit of excellence in all aspects of gymnastics.

### **G. Requirements to Member Clubs**

USA Gymnastics strongly encourages local clubs to join with USA Gymnastics in taking affirmative steps beyond those described in Section F to promote a safe environment for all gymnastics participants by:

1. Adopting additional “Prevention Policies” to foster a safe gymnastics environment and to prevent abusive situations, and by training staff and volunteers to implement such policies;
2. Implementing a thorough hiring process including, for example, reference and criminal background checks;
3. Encouraging parents/guardians to become as active as reasonably possible in his/her child’s gymnastics activities; and
4. Otherwise implementing policies and procedures to lessen the likelihood that an abusive situation and athlete grooming could develop.

### **H. Event Sanctions**

As a condition for being granted a USA Gymnastics sanction for an event, the applicant must certify that no persons permanently ineligible for USA Gymnastics membership, and no persons listed on a federal or state sex-offender registry, will be associated with the event in any capacity, including, but not limited to, volunteers and meet support personnel.

Sanctioned events may only be hosted by Member Clubs.

### **I. Advertising/Trade Shows**

As a condition to place advertising in USA Gymnastics publications, on its web site or through other USA Gymnastics media platforms/publications, or to participate in USA Gymnastics Congress Regional/National Trade Shows, advertisers, vendors and exhibitors must certify that no persons permanently ineligible for USA Gymnastics membership are or will be associated with the advertiser’s gymnastics-related activities, the position, activity, or event it intends to publicize; or the vendor or exhibitor’s on-site activities.

### **J. Hiring/Training of USA Gymnastics Staff/Volunteers**

1. USA Gymnastics staff members must complete criminal background screening consistent with USA Gymnastics’ “Background Screening Policy.” Individuals not given a “Green Light” consistent with that policy prior to their employment may not be hired. Individuals not given a “Green Light” on any subsequent criminal background screening may be subject to dismissal.
2. USA Gymnastics shall also check at least two (2) references for each applicant.
3. All USA Gymnastics staff members will be informed about the Safe Sport Policy, which is included as an appendix in the *Employee Policies & Procedures Handbook*, and made aware of its importance to our members and our organization.
4. The members of the USA Gymnastics Board of Directors must submit to criminal background screening consistent with the Criminal Background Screening Policy. Individuals not given a “Green Light” consistent with that policy may be subject to removal.

### **K. Education of the Gymnastics Community**

USA Gymnastics will provide education for members of the gymnastics community geared toward promoting a safe gymnastics environment by:

1. Requiring members to complete a designated safe sport course every two years.
2. Designating a section of its website, [usagym.org/SafeSport](http://usagym.org/SafeSport), with educational and safe sport content that is updated as necessary;
3. Featuring articles on athlete safety online and in its magazines;
4. Conducting a live presentation at each National and Regional Congress;
5. Providing online or electronic access through the Safety/Risk Management Certification or other USA Gymnastics University courses;
6. Providing brochures and/or posters to members and Member Clubs;
7. Addressing the topic at minimum annually in designated Athlete meetings, with designated Athletes’ parents, and with USA Gymnastics’ staff members.
8. Including information in its publications, where appropriate, including the *Safety/Risk Management Handbook* and each discipline’s *Rules and Policies*.

**L. Professional Development**

Professional and Instructor members of USA Gymnastics should strive to increase their level of proficiency and skill by remaining current on safety, health and training developments relevant to the sport and by seeking advice and counsel of colleagues and experts whenever such consultation is in the best interests of the gymnast.

**M. Communication**

USA Gymnastics will consistently communicate:

1. Its mission and that misconduct is inconsistent with its mission and the best interest of its participants and the sport of gymnastics.
2. Its commitment to, and working toward, a safe environment for all gymnastics participants.

**N. Document Retention**

USA Gymnastics will permanently retain misconduct / grievance files and materials.

**O. Policy Review**

Safe Sport policies will be reviewed at least annually and updated as necessary.

## Chapter 1 - Membership

100% of the athletes, coaches and judges participating in a USA Gymnastics Sanctioned Event must be pre-registered as an Athlete, Introductory Athlete, Professional, or Junior Professional member of USA Gymnastics. Any athlete, coach or judge who is unable to be verified, as a current USA Gymnastics member will be ineligible to participate in any USA Gymnastics sanctioned event. In addition, any and all athletes who wish to compete USA Gymnastics sanctioned events must be affiliated with a current USA Gymnastics Member Club.

### I. Athlete Membership

Athlete's that wish to participate in USA Gymnastics sanctioned events MUST be affiliated with a current Member Club.

- A. Athlete Membership is effective once a USA Gymnastics Athlete Member number has been assigned to the competitive athlete.
- B. Introductory Athlete Membership is available for a fee of \$29.00 for levels 1 or 2, and Xcel Bronze and Silver divisions. Introductory Athlete Membership may be upgraded to full Athlete Member (Level 3 and above) within the same competitive year by completing a regular Athlete Member registration form and paying the additional \$32.00.
- C. Athlete Member Numbers are assigned only after:
  - 1. Payment of \$61.00 in full is received.
  - 2. The Athlete Membership [online membership registration and/or](#) membership application form is received fully completed with all required information and signatures.
- D. Member benefits are paid out upon receipt of application; therefore, memberships are **nonrefundable** and nontransferable.
- E. The Athlete Membership is valid for one competitive year, from August 1 through the following July 31.
  - 1. Members joining at any time during the year will receive benefits for the remainder of the competitive year.
  - 2. All Athlete Memberships are automatically null and void each July 31.
- F. Membership forms are available online at [usagym.org/forms](http://usagym.org/forms). For more information regarding Athlete Membership terms, conditions and registration, please contact Member Services at 800-345-4719 or via e-mail at [membership@usagym.org](mailto:membership@usagym.org).
- G. In order for an athlete to compete he/she must be affiliated with a member club of USA Gymnastics.

### II. Athlete Members Rights And Obligations

- A. ALL GYMNASTS HAVE THE RIGHT TO:
  - 1. Compete in the meet if she has met all the requirements for eligibility (entry, score, and age requirements) and is properly entered.
  - 2. Use any of the facilities provided by the meet organizing committee.
  - 3. Use the services of any person connected officially with the meet (i.e. physician, trainer, music manager, etc.).
  - 4. In the case of a tie, expect her award to be mailed to her club address, free of charge, not later than one (1) month after the completion of the meet, if the award is not available at the meet.
  - 5. Expect courteous and respectful treatment from all participants and meet personnel.
  - 6. Expect that the competition site will provide a safe and adequate environment, allowing her to perform to the best of her ability.
- B. THE GYMNAST IS OBLIGATED TO:
  - 1. Obtain an Athlete or Introductory Athlete (Levels 1 or 2 and Xcel: Bronze, Silver, Gold, Diamond, Platinum) Member number from USA Gymnastics Member Services and be prepared to show her membership card at any USA Gymnastics-sanctioned event in which she participates.
  - 2. Be affiliated with a USA Gymnastics Member Club
  - 3. Follow the USA Gymnastics Code of Ethics.
  - 4. For adult athletes they must complete the U.S. Center for SafeSport Core Course Training
  - 5. Be competent at Levels 1 through 3 prior to participating in Level 4 meets.
  - 6. Be familiar with the rules of the meet and schedule of the meet events and lineup.
  - 7. Be present at the site of the meet for sufficient warm-up.

## Chapter 1

8. Remain in the area of competition designated for gymnasts, as competitors or as observers.
9. Obey warm-up regulations, rotation schedules and conform to the regulations of the meet.
10. Present herself in the proper attire. A deduction for "inappropriate" attire will be applied for any infraction.
  - a. No bare midriffs, backless leotards, leotards with "spaghetti" straps, T-shirts or Boxer shorts.
    - EFFECTIVE AUGUST 1, 2020: A leotard is considered backless when the open area extends past the bottom of the bra line, and the open area extends past the vertical midpoint of the scapula, unless the open area is filled with mesh or flesh-colored fabric.
  - b. NO underwear (including sport bras) should be exposed.
    - A clear bra is acceptable.
  - c. The leg opening on competitive leotards must NOT be cut or rolled above the gymnast's hipbone.
  - d. Sleeveless leotards and unitards with ankle length legs, as well as gymnastics footwear, are permitted for competition. Leotard and/or warm-up uniforms should be worn for march-in and award ceremonies. Tennis shoes (athletic sneakers) are NOT considered gymnastics footwear. If the athlete wears tennis shoes while competing, a 0.20 deduction for inappropriate attire will be applied.
    - In addition to a leotard or ankle-length unitard, acceptable attire would also include ankle-length tights worn under the leotard (that match the leotard or are skin tone).
  - e. Gymnasts must change clothes in the designated changing area or restroom. They may not appear in underwear on the competition floor or warm-up area before, during or after the competition.
  - f. At USA Gymnastics sanctioned events, a gymnast may NOT participate in warm-up or competition wearing a hard, non-removable cast.
10. Be well groomed in her appearance:
  - a. Clean attire.
  - b. Hair secured away from the face so as to not obscure her vision of the apparatus.
  - c. No jewelry, with the exception of one pair of stud earrings (one in each ear). All other piercing should be REMOVED, not just covered with tape or Band-Aids.
11. Accept the received score without criticism or comment.
12. Eat or drink outside of the competition area (exception; water bottles should be allowed, or a water fountain should be accessible in order for athletes to stay hydrated.)
13. Be courteous, respectful and polite to all meet officials, coaches, hostesses, competitors and associated persons. The use of cell phones (talking, texting, etc.) or any type of wireless communication device is prohibited while on the field of play (competition area).
14. Exhibit self-control and calmness in the case of a fall or injury.
15. Be aware that infringement of obligations could lead to deduction and/or expulsion by the Jury of Appeals.
16. Flash her vault number at state level and above optional meets.

### III. Athlete Residency/Club's State Championships Determination

- A. The physical location of the gymnast's training facility determines the residency of the gymnast.
- B. If the gymnast resides in one state and her training facility is located in another neighboring state, the following regulations exist:
  1. A gymnast may compete in the State Championships based upon:
    - a. The state in which her training facility is physically located, OR
    - b. The state in which she actually resides.
  2. The gymnast may NOT compete in both State Championships.
  3. The gymnast must compete in the proper Regional meet, based upon the State Meet in which she competed.
- C. A club MUST compete in the State Championship(s) of the state in which the training facility is physically located.
  1. Clubs that have gyms in different locations (under the same ownership) have the option of competing under one club name or as separate clubs. The decision must be made at the beginning of the competitive year and communicated to the State and/or Regional Administrative Committee Chairman, if appropriate.
  2. If two different clubs (different names/owners) are coached by the same person, the State Administrative Committee may decide if the clubs may compete as one combined team in USA Gymnastics qualifying meets and State Championships.

## Professional Memberships and Responsibilities

- Membership forms are available online at [usagym.org/forms](http://usagym.org/forms). For more information regarding Professional Membership terms, conditions and registration, please contact Member Services at 800-345-4719 or via e-mail at [membership@usagym.org](mailto:membership@usagym.org).
- Member benefits are paid out upon receipt of application; therefore, memberships are nonrefundable and nontransferable.
- Membership is valid for one competitive year, from August 1 through the following July 31.
  - ❖ Members joining at any time during the year will receive benefits for the remainder of the competitive year.
  - ❖ Memberships are automatically null and void each July 31.
- Information about the various certifications, programs, and accreditations for professional members is offered in the USA Gymnastics University is available online at: [usagymnasticsuniversity.org](http://usagymnasticsuniversity.org).
- Professional Members coaching at sanctioned events must have a minimum certification level of instructor Certified in USA Gymnastics University. Instructor Certification can be achieved by completing the U100 Fundamentals of Gymnastics Instruction course.

### I. Professional Membership

- A. Professional Membership is open to any coach, judge or gymnastics professional that is a minimum of 18 years of age. Completion of USA Gymnastics Safety/Risk Management Certification, **U110: U.S. Center for SafeSport Core Training** and NCSI Criminal Background Check are requirements for Professional Membership.
  - Professional members that wish to coach on the floor of sanctioned competitions must also have the U100: Fundamentals of Gymnastics Instruction "Instructor Certification".
- B. The annual fee for Professional Membership in one discipline is \$91.00.
- C. USA Gymnastics Professional Member must hold a Professional Membership for each and every discipline in which he or she is participating.
  - An additional \$15.00 per discipline will be applied.

### II. Junior Professional Membership

- A. Junior Professional Membership is available only for coaches or judges who are 16-17 years of age and are coaching/judging USA Gymnastics-sanctioned events.
  1. Safety/Risk Management Certification is a requirement for Junior Professional Membership.
  2. A Professional Member must accompany Junior Professional members in order to be on the field of play (competition area) as a coach.
  3. Junior Professional members who wish to coach on the floor of sanctioned competitions must also have the U100: Fundamentals of Gymnastics Instruction "Instructor Certification".
- B. The annual Junior Professional Membership fee is \$91.00.
- C. Once the individual turns 18 years of age, he/she may apply for a Professional Membership.
  - **Upon the date of their 18<sup>th</sup> birthday, the U110: U.S. Center for SafeSport Core training must be completed.** They will be required to renew as a Professional Member once the Junior Professional membership has expired; however, as long as they have a Junior Professional Membership, they are required to be accompanied by a Professional Member.

### III. Professional Member Behavior Policy

- A. Any falsification of official documentation (scores, athlete date of birth, athlete member number, etc.) will result in the removal of the athlete from competition and may result in disciplinary action against the responsible Professional member.
- B. At USA Gymnastics Sanctioned Events, unacceptable coach behavior is defined as:
  1. Verbal, emotional, sexual, or physical abuse of a gymnast.
  2. Abuse of alcohol or drugs. (Refer to meet director responsibilities for actions)
  3. Inappropriate remarks or comments, harassment, and/or gestures directed toward any official or meet personnel during the competition. No coach has the right to demand a last-minute change in the course of the meet or to jeopardize the athlete/competition in any way, unless there has been a violation of the *Rules and Policies*.
  4. Contact with other persons outside of the competitive floor area during the actual warm-up and course

## Chapter 1

- of competition. (Exceptions: USA Gymnastics or club doctor, trainer, other credentialed personnel)
5. Derogatory remarks to the press in regard to USA Gymnastics, its designated representatives, meet officials or personnel.
  6. Violating any of the coaches' or judges' specific responsibilities as listed later in this chapter.
- C. Unless otherwise specified, such above described behavior will be penalized as follows:
1. First Offense: Verbal warning will be issued by the Meet Director in conjunction with the Meet Referee/Technical Director and/or designated representative of USA Gymnastics. The warning must be documented and recorded by the Meet Referee on the sanction report form.
  2. Second Offense: Withdrawal of floor credential, necessitating ejection from the competitive floor area (or possibly the entire competitive arena).

### IV. Coaches' Specific Responsibilities

All Coaches are obligated to:

- A. Maintain a USA Gymnastics Professional or Junior Professional (if 16-17 years old) membership. Safety Certification is a pre-requisite for Professional and Junior Professional memberships. U100: Fundamentals of Gymnastics "Instructor Certification" are required for anyone that intends to coach at a sanctioned competition. Any Professional and Jr. Professionals who turn 18 prior to their Jr. Professional membership expiration date are required to complete the U110: U.S. Center for SafeSport Core Course. A Criminal Background Check and the U110 Safe Sport Training are required for all Professional members. Junior Professional members are exempt from the Criminal Background Check and the U110.
1. At sign-in at all USA Gymnastics-sanctioned events, all Professional and Junior Professional members must be prepared to produce their current Membership card listing valid dates for membership, Safety Certification, U100 Certification, U110 Safe Sport Training and Criminal Background check certification or an event-specific credential (indicating that the Meet Director checked their memberships and pre-requisites prior to the competition). Members must also be prepared to show proof of valid membership in the field of play (competition area) if so requested.
  2. If upon renewing a membership, the member is unable to print a new Membership Card, a receipt to confirm that their membership and pre-requisites are up-to-date may be printed in lieu of the card. A temporary certificate for successfully completing the Safety/Risk Management certification, U100 and U110 Certifications/Training may also be printed as proof of compliance.
- B. Follow the USA Gymnastics Code of Ethical Conduct.
- C. Be professional
1. Display good sportsmanship.
  2. Dress in attire reflecting the best image of gymnastics. USA Gymnastics prohibits clothing that promotes drug or alcohol use, is vulgar, obscene or worn in a manner that draws attention away from the competitive environment. At State meets and above, the coaches' dress code is as follows:
    - a. Athletic shoes with rubberized soles. Athletic warm-up pants or "Docker-style" pants (No jeans).
    - b. Athletic or tailored shorts that are of a reasonable length. No holes, tears or short shorts.
    - c. Collared shirts, business casual shirts or T-shirts with or without gym logo. (No spaghetti straps, low-cut tops or midriff revealing shirts).
    - d. No hats or visors.
  3. Be mentally and physically prepared and rested in order to provide the safest environment for the gymnast.
  4. The use of cell phones for verbal conversation in PROHIBITED while on the field of play (competition area). Coaches are permitted to record their OWN gymnasts' exercise for personal use but should not in any way interfere with the competition.
  5. At a USA Gymnastics sanctioned event, no e-cigarettes are allowed on the field of play.
  6. At a USA Gymnastics sanctioned event, no firearms or dangerous weapons are allowed on the field of play.
    - Weapons include, but are not limited to firearms, sling shots, sand clubs, metal knuckles, daggers, dirks, spring blade knives, nun-chu-ka sticks, throwing stars, air guns, stun guns, and devices intended to injure a person by an electric shock.
  7. For the safety of the athlete, at all USA Gymnastics sanctioned events, a coach (professional or junior professional member) may NOT actively spot or assist an athlete on a skill during warm-up or competition while wearing a cast or medical device that limits mobility in any way.
- D. Attend all coaches' meetings and be familiar with the meet set-up and organization.
- E. Be present at all warm-up and competition sessions. Check the time of floor exercise music on the official music playback equipment prior to competition and report any problems to the Meet Referee.



## Chapter 1

1. Must provide Floor exercise music in digital format (MP3, computer, tablet, smart phone, etc.). CD playback equipment is no longer provided by the Meet Director.
  2. These electronic devices must have a display screen and must be on airplane mode, when applicable.
- F. Be respectful of and responsible for his/her athletes at all times during the travel to and from the competition, at the training prior to competition, during the off hours, and during the competition itself.
- G. Follow all guidelines for the competition as stated in the *USA Gymnastics Rules and Policies*, including entry regulations.
- H. Continually update coaching knowledge and experience on a planned regular basis, by means of study, review of films, attending workshops, and participating in clinics, etc.
- I. Treat all competitions the same, regardless of the skill level.
- J. Set an example for the athletes by displaying a positive attitude and exemplary conduct.
- K. Show respect for all gymnasts, coaches, judges, and meet personnel.
- L. Coach gymnasts from their own team only, unless another coach asks for assistance or a gymnast has no coach available. It is inappropriate to conduct a coaching clinic during the competition.
- M. Direct any inquires regarding apparatus, judging or meet schedules through the Meet Referee or Meet Director.
1. Refrain from approaching a judge directly.
  2. Instruct their gymnasts and parents to discuss any concerns they may have with the coach.
- N. Inform the gymnasts and gymnasts' parents of all competitive requirements, as well as their rights and obligations.
- O. Obtain an Accident Report Form signed by the Meet Director and/or medical personnel in the case of any injury to a gymnast for whom they are responsible. Accident Report forms will be included in the Sanction packet sent to the Meet Director, who will duplicate and provide copies for the medical personnel. The coach or parent of the injured athlete must be sure to secure this form, completed by the medical personnel and signed by the Meet Director, prior to leaving the competition.
- P. Show respect for the United States flag and the National Anthem.
- Q. At a USA Gymnastics sanctioned event, if any Professional Member of USA Gymnastics witnesses action by a coach and believes that the safety of an athlete is in question (for example: risk of catastrophic injury, concussion, etc.), that Professional Member should report the matter to the Meet Director.
1. The Jury of Appeals will then promptly review and resolve any issue related to the matter by the following process:
    - a. Discussion
    - b. Decision by a majority vote
  2. A decision by the Jury of Appeals may include a warning to the coach for improper behavior or such other action as the Jury of Appeals determines to be warranted and may include action to ensure the safety of the athlete. A decision of the Jury of Appeals is final and binding and is not subject to appeal.
  3. The Jury of Appeals is comprised of the following individuals:
    - a. Meet Director (unless affiliated with the inquiry, for example, if question relates to his/her gymnast.
    - b. Meet Referee (President of the Jury)
    - c. Chief Judge of the Event in question
    - d. If available, one USA Gymnastics representative (Elected State or higher Committee member, or Regional or National officer.
  4. However, the Jury of Appeals for Regional and higher level competitions is comprised of the following:
    - a. Meet Director (unless affiliated with the inquiry)
    - b. Meet Referee (President of the Jury)
    - c. USA Gymnastics elected Administrative Officers

## V. Judges' Specific Responsibilities (see also Chapter 5: Meet Officials)

All Judges are obligated to:

- A. Maintain a USA Gymnastics Professional (or Junior Professional if 16-17 years old) Membership. A Criminal Background Check, Safety Certification, and U110 Safe Sport Training are pre-requisites of Professional Membership; Junior Professional members who turn 18 prior to their Jr. Professional membership expiration date are required to complete the U110: U.S. Center for SafeSport Core Course. are exempt from the Criminal Background check and the U110.
1. At sign-in at all USA Gymnastics-sanctioned events, all Professional and Junior Professional members must be prepared to produce their current Membership card listing-valid dates for membership; Safety Certification, U110 Safe Sport Training and the Criminal Background check or an event-specific credential (indicating that the Meet Director checked their memberships and pre-requisites prior to the competition). Members must also be prepared to show proof of *valid* membership in the

## Chapter 1

field of play (competition area) if so requested.

2. If upon renewing a membership, the member is unable to print a new Membership Card, a receipt to confirm that their membership and pre-requisites are up-to-date may be printed in lieu of the card. A temporary certificate for successfully completing the Safety/Risk Management certification may also be printed as proof of compliance.
- B. Maintain USA Gymnastics Judges' Accreditation ratings for the appropriate level of competition and be current with Continuing Professional Education (CPE) requirements.
  - C. Follow the USA Gymnastics Code of Ethics.
  - D. Be professional.
    1. Dress appropriately, regardless of the level of competition, in the required uniform (Navy skirt/pants and jacket, white blouse/shirt). (Exception: theme invitationals)
    2. Be mentally and physically prepared and rested in order to evaluate all gymnasts as accurately as possible.
    3. Be quick, cooperative and efficient in resolving differences during a conference.
    4. Remain at their event station until the entire competition is completed.
    5. The use of cell phones (talking, texting, etc.) or any type of wireless communication device is prohibited while on the field of play (competition area). Judges may use electronic tablets for gymnastics purposes only on the Field of Play.
  - E. Serve only in the capacity of an official during warm-ups and competition. They may not act in a dual capacity (i.e., coach/judge, parenting/judge, Meet Director/judge, Announcer/Judge, etc.).
  - F. Be familiar with the meet setup and organization. No judge has the right to demand a last-minute change in the course of the meet or to jeopardize the athlete/competition in any way unless there has been a violation of the *Rules and Policies*.
  - G. Fulfill all assignments according to the contractual agreement. Only dire circumstances should prohibit a judge from fulfilling an assignment. If a judge must cancel an assignment, she/he must notify the appropriate officials at the earliest possible moment.
  - H. Refrain from conversation with other judges and coaches during the competition. In addition, the judges' responsibility does not involve the conduct of the gymnast(s) during warm-up or training. Any conversation or comments with the athlete should be made only if requested by the coach or athlete.
  - I. Show respect for all gymnasts, coaches, judges, meet personnel and volunteers.
  - J. Be confidential about meet matters, their own scores or other judges' scores or opinions.
  - K. Update judging knowledge and experience on a planned, regular basis, which includes studying, practice judging with videos or live athletes, attending courses, and judging as much as possible.
  - L. Treat all competitions the same, regardless of skill level.
  - M. Avoid judging a meet in which any personal bias (positive or negative) towards any competing team and/or individual athlete would affect their ability to judge objectively.
  - N. Set a good example for the athletes by displaying a positive attitude and exemplary conduct.
  - O. Show respect for the United States flag and the National Anthem. Remember we teach by example.
  - P. Be considerate of the Meet Director's equipment by refraining from wearing footwear that could be damaging to the mats and/or floor.
  - Q. Refrain from soliciting invitations to judge specific competitions by making direct contact with the Meet Director.

## Chapter 2 - Foreign Participants

The US Olympic Committee recognizes USA Gymnastics as the governing body for the sport of gymnastics in the United States. As such, USA Gymnastics has authority over all gymnastics competitions, exhibitions, and training exchanges hosted in the United States.

USA Gymnastics is a member of the Federation of International Gymnastics (FIG), the International governing body for gymnastics. As such, USA Gymnastics and all its members are subject to the FIG rules and regulations governing gymnastics exchanges between countries. All exchanges involving foreign athletes are under the jurisdiction of the FIG and the host Federation.

With the increased opportunities for participation in events involving foreign athletes, both in the United States and abroad, USA Gymnastics has the responsibility to inform its Professional members of the FIG regulations governing these activities. The FIG and its member federations have jurisdiction over international events (events involving more than one country's athletes). Violations of the FIG regulations can result in restrictions of the member federation and/or its athletes. While USA Gymnastics realizes the cultural enrichment that these types of events provide to our members, strict compliance to the FIG Regulations MUST be followed.

The USA Gymnastics National office must be notified of any competitions in the U.S. involving athletes, coaches and/or judges who are non-citizens and also reside in and/or represent a foreign country. The USA Gymnastics National office must be notified of any U.S. athletes or judges' intention to participate in any gymnastics activities in a foreign country.

Any non-U.S. citizen residing in the United States, who intends to participate in any gymnastics activity within the United States, must notify their country of citizenship gymnastics federation of their intention to participate in gymnastics activities within the United States.

### I. Foreign Memberships

Athletes, Coaches, and/or Judges from Countries other than the United States.

- A. A foreign athlete/coach/judge membership must be obtained by submitting a completed membership form along with a fee of \$50.00 to USA Gymnastics member services department.
- B. All foreign memberships are null and void each July 31<sup>st</sup>.
- C. Foreign Memberships do NOT receive benefits of membership other than the required insurance coverage at the sanctioned event(s).
- D. The Foreign Participant Membership form is available in Forms Section at [www.usagym.org/forms](http://www.usagym.org/forms).

CONTACT THE USA GYMNASTICS MEMBER SERVICES DEPARTMENT FOR ASSISTANCE AND DIRECTION.  
DO NOT DIRECTLY CONTACT ANY FOREIGN FEDERATION, CLUB, ATHLETE, COACH OR JUDGE.

### II. Duties and Responsibilities of USA Gymnastics Professional Members in regards to International Exchanges

- A. EXCERPT FROM THE STATUTES OF THE FEDERATION INTERNATIONALE DE GYMNASTIQUE (FIG)  
VII. OFFICIAL EVENTS OF THE FIG AND ELIGIBILITY OF GYMNASTS  
Art. 36.3 Inter-Federation events and responsibilities of Federations Federations may organise events among themselves in accordance with the Statutes and Regulations of the FIG. It is, however, forbidden for gymnasts or judges of a Federation to participate in competitions or demonstrations in the sphere of activity of another Federation without the prior consent of the Federations involved and that of the Federation organising the event. Likewise, the participation of gymnasts or judges of a Federation in an event organised by a body other than a Federation must be subject to the prior consent of any Federations involved. Federations are also responsible to FIG for the behaviour of their gymnasts, coaches, judges and other officials and they act as guarantors to the FIG in respect of these responsibilities. After every competition, the Federations will send to the FIG the requested documents (see FIG Rules "International Event Approval") as well as, within 30 days, the tax ratified by the Council (see art. 28.3).

Refer to the [FIG Code of Discipline](#) for additional information.

- B. Any competition/exhibition conducted in the United States, which includes foreign athletes, must be sanctioned by USA Gymnastics.
- C. The sanction fee will be determined based upon the particulars of the event (up to \$250,000.00). Do not send any invitations (foreign or domestic) until the USA Gymnastics Member Services department has notified you that approval has been granted.

### III. Requirements for Foreign Exchanges

The following categories have been defined for participation of foreign athletes in this country and for participants of USA club athletes in a club exchange in a foreign country. All exchanges involving foreign athletes are under the jurisdiction of the FIG and the host Federation. Every procedure MUST be followed to protect the athletes and the federations.

- A. Competitions/Exhibitions conducted in the United States
  - 1. Prior approval of Foreign Federation must be secured through request made by USA Gymnastics.
  - 2. All aspects of the event MUST be approved by USA Gymnastics. This includes but is not limited to:
    - a. sponsorships
    - b. marketing/property rights
    - c. equipment/format
    - d. television
    - e. all promotional, marketing, and advertising materials
  - 3. The use of the word "INTERNATIONAL" in the title of a competition/exhibition is strictly FORBIDDEN.
  - 4. Promotion or advertising depicting the event as a competition between two or more countries is forbidden. (i.e., USA vs. Canada)
    - Athletes from a foreign country competing in the United States represent only their club at the exchange; they are NOT representing their country as a National Team member.
  - 5. Higher sanction fees may be assessed for galas or exhibitions depending upon the level of the participating athletes.
  - 6. FIG has a 5% tax on prize money awarded at an event.
- B. Training Exchanges conducted in the United States
  - 1. Prior approval of foreign Federation must be secured through a request made by USA Gymnastics.
  - 2. Only a letter of invitation with the specific information is required; however, it is not necessary to sanction.
  - 3. Proof of Insurance coverage:
    - a. It is the sole responsibility of the event host to secure proper insurance for the event. (Be aware that some insurance packages do not cover foreign athletes or coaches.)
    - b. Training exchanges may not be "USA Gymnastics-sanctioned"; therefore, the Athlete Member insurance is not in effect.
  - 4. Prior notification to USA participants that they represent only their club at this exchange and they are not participating as official USA representatives.
- C. Competitions, exhibitions and training exchanges conducted in another country
  - 1. USA Gymnastics must receive communication from the host country requesting permission for USA Gymnastics members to attend.
  - 2. USA Gymnastics must approve of your club's participation BEFORE your club accepts an invitation to participate in another country's event. Notification requesting permission to participate in a foreign competition, exhibition or training exchange must be provided to the Program Director at the USA Gymnastics office.
  - 3. Events sponsored by and/or held in a foreign country CANNOT be "USA Gymnastics-sanctioned"; therefore, the Athlete Member insurance is not in effect. Prior notification to USA participants that USA Gymnastics insurance does not cover their participation in an event sponsored by and held in a foreign country is required.
  - 4. Any judge (US or foreign citizens) must receive permission from the National Federation of their country of citizenship before accepting an invitation to officiate a competition that is conducted outside of their country of citizenship.
  - 5. USA participants may only represent their club at these events/exchanges and they may not participate as official USA representatives.
    - a. For example: Official results may not reflect "USA".
    - b. Prior notification to USA participants that they represent only their club at this exchange and they are not there as official USA representatives is required.

6. USA National Team members may not represent their club in an international event without the approval of the Program Director or the National Team Coordinator.

#### IV. Eligibility and JO Participation Requirements for Foreign Athletes Residing in the USA

- A. **Foreign athletes (US Citizens residing in a foreign country or non-US Citizens):** Foreign athletes who have competitive experience outside the US and now reside in the US are eligible to petition by submitting a formal written request to the Regional Junior Olympic Committee Chairman for entry into the Junior Olympic Program at Level 8 or above or the State Administrative Committee Chairman for Level 7 or below. The petition must be accompanied by a video that demonstrates the skill level for which she is submitting the petition and proof of residency outside the US.
  1. Non-U.S. citizen athletes who are living in the United States and training in a U.S. gymnastics club are eligible to compete and receive awards for all USA Gymnastics Junior Olympic sanctioned events, including State, Regional, East/West, and JO National Championships.
    - a. If a non-citizen athlete places in the top four (4) All-Around at Junior Olympic Nationals, she will receive the award for her AA placement; however, she is not eligible to become a member of the Junior Olympic National Team. In this instance, the next US citizen in rank order will be placed on the Junior Olympic National Team.
  2. Foreign athletes (those that reside and/or train in another country) are eligible for individual as well as Team awards at any Invitational competition that has secured a foreign sanction from USA Gymnastics.
- B. **Foreign Elite athletes who have represented a foreign country and Foreign Elite National Team Members (current or former):** A US Citizen or non-US Citizen, Elite gymnast, residing in the US who wants to compete in the Junior Olympic Program who is currently named to, has previously competed for, or has represented a foreign national team, must petition to enter to the Junior Olympic program by sending a formal written request and proof of citizenship (driver's license, birth certificate, passport) to the National Junior Olympic Committee Chair. In addition to the formal request, the athlete must request documentation be sent to the Senior Vice President of Women's Program at USA Gymnastics directly from the country's federation in which she has competed, granting the athlete permission to compete in the Junior Olympic Program for the US Club.
  1. The two-step process must be completed before the athlete's scores achieved in the Junior Olympic Program are valid for any qualifying purposes.
  2. Once proper documentation has been received by USA Gymnastics, the athlete may compete in the Junior Olympic Program and represent her club up to, and including Regional Championships for the current competitive season.
  3. For the athlete to remain eligible to compete in the Junior Olympic Program, this process must be completed annually.
  4. If the athlete is a US Citizen or has retained a green card (demonstrating intent to become a US Citizen), and wishes to participate in the Junior Olympic Program, she must petition to enter the Junior Olympic Program by sending a formal written request to the National Junior Olympic Committee Chair. In addition to the formal request, the athlete must request documentation be sent to the Senior Vice President of Women's Program at USA Gymnastics directly from the country's federation in which she has competed, granting the athlete permission to compete in the Junior Olympic Program for the US Club.
    - a. The two-step process must be completed before the athlete's scores achieved in the Junior Olympic Program are valid for any qualifying purposes.
    - b. Once proper documentation has been received by USA Gymnastics, the athlete may compete in the Junior Olympic Program and represent her club up to, and including East/West Championships and Junior Olympic National Championships.
    - c. If the athlete has a green card but is not yet a US Citizen, and places in the top four (4) All-Around at Junior Olympic Nationals, she will receive the award for her AA placement; however, she is not eligible to become a member of the Junior Olympic National Team. In this instance, the next US citizen in rank order will be placed on the Junior Olympic National Team.

#### V. General Foreign Sanction Procedures

Competitions/Exhibitions conducted Inthe United States:

Every procedure MUST be followed to protect the athletes and the federations.

- A. If the event involves athletes and is a competition /camp/clinic/ exhibition, a USA Gymnastics *Foreign* Sanction is REQUIRED.
- B. Submit a completed Request for Foreign Sanction form, with the application fee of \$140 no later than 120 days prior to the event date to USA Gymnastics Member Services, Attention: FOREIGN SANCTIONS.

## Chapter 2

- C. ONLY one discipline per foreign sanction request. A separate foreign sanction request must be submitted for each competing discipline.
1. If received in less than 120 days, an additional \$100.00 rush fee is due.
  2. Additional countries may be added no less than (14) business days of the event for a fee of \$25 per country.
- D. The final Foreign Sanction fee will be determined based upon the particulars of the event (up to \$250,000.00). Do not send any invitations (foreign or domestic) until the USA Gymnastics Member Services department has notified you that approval has been granted.
- E. Higher sanction fees may be assessed for galas or exhibitions depending upon the level of the participating athletes.
- F. After receiving the Foreign Sanction request form/payment, USA Gymnastics will contact the foreign federation to request their approval for their athletes/coaches to participate.
- G. All participants residing in the USA must have the appropriate USA Gymnastics membership and certifications.

## Chapter 3 – Sanctions

### Sanctions

In order to host a USA Gymnastics women's sanctioned competition, all Meet Directors MUST be a current USA Gymnastics Professional member with a current safety/risk management certification, U110 [U.S. Center for SafeSport Core Course](#), and criminal background check, as well as meet director certification. In addition, the Meet Director must be affiliated with a current Member Club. Meet Director Exam is available online at <https://usagym.org/pages/education/courses/W202/>.

An unaffiliated athlete will not be permitted to participate in the event.

#### I. Sanctioning a Domestic USA Gymnastics Event

- A. USA Gymnastics, as the national governing body for the sport, is responsible for the granting of sanctions.
- B. Sanctions are required for all USA Gymnastics competitions. See Chapters 6 and 8 for competition guidelines.
- C. Sanctions may also be obtained for clinics, workshops, educational events, tours and exhibitions.
- D. Only a current USA Gymnastics Member Club may register athletes into a sanctioned event.
- E. A USA Gymnastics sanctioned event **CANNOT** be run concurrently in the same session with non-USA Gymnastics sanctioned event.

#### II. Procedures for Requesting a Domestic Sanction

- A. Request for sanctions may be obtained either online or by faxing/mailing the sanction request form to the Member Services Department.
- B. To apply for a sanction online or to access forms visit [usagym.org/member-services](http://usagym.org/member-services).
- C. Only domestic sanctioned events may be applied for online.
- D. When requesting a sanction, equipment/venue set-up/ take down and training days must be included, as well as competition days.
- E. Only one discipline per sanction.
- F. Events conducted in more than one location must have a separate sanction for each location.
- G. Once a sanction has been granted, the *USA Gymnastics Women's Rules and Policies* must be followed. Please see Chapter 4 for specific meet director responsibilities.
- H. Domestic Sanction Fee
  - The fee is \$140.00 for ALL domestic sanctioned events. Sanction fees (and any late fees) are not refundable, regardless of the reason for canceling a meet.
- I. Foreign Sanctions
  - For events in which foreign athletes and coaches participate, a foreign sanction request form and fee of \$300.00 must be sent via mail/fax/e-mail to the Member Services department for processing. For more details, see Chapter 2, Events with Foreign Participation.
- J. Rush Fees
  - Sanction request for in-house processing 7 business days or less than the start date of the event will be assessed a \$25.00 rush fee. Online request will not incur a rush fee.

#### III. Sanction Violations and Penalties

SANCTION VIOLATIONS MAY RESULT IN A FINE, VOIDING OF A COMPETITION AND ITS RESULTS, AND/OR LOSS OF SANCTIONING PRIVILEGES.

- A. Sanction Violations
  - When a Meet Director and/or Professional/Junior Professional member(s) participating in the event fails to follow the *USA Gymnastics Women's Rules and Policies*, actions can be taken against the Meet Director, hosting institution and/or the individual offenders by the USA Gymnastics National Office.

## Chapter 3

- B. Violations on the part of the Meet Director include:
1. Allowing coaches, judges and/or athletes on the floor without current, valid memberships and/or educational/background check certifications. This includes Professional members, Junior Professional members, Athletes and Introductory Athlete members.
  2. Violations of any regulation within the Rules and Policies.
  3. Improper timing of the competition:
    - a. Athletes in the gym too long (over 5 hours).
    - b. Starting the warm-ups before 8:00 A.M.
    - c. Finishing after 10:00 P.M. due to poor scheduling.
  4. Failure to return required sanction forms and athlete fees by the designated deadline.
  5. Altering USA Gymnastics language on sanction report form.
  6. Failure to obtain signatures/initials of officials/coaches on the sanction report form sign-in sheet(s).
  7. Exceeding the maximum allowable number of gymnasts in a session.
- C. Violations on the part of a competitor:
- If an individual gymnast is in violation of the regulations, she will be disqualified, and all awards returned. (Example: wrong Level, wrong age division)
- D. Violations on the part of a coach/judge:
- Individuals who do not have the appropriate current Professional, Junior Professional Membership and/or educational or background check certifications or falsifies one of the above-mentioned memberships and attempts to participate on the field at a USA Gymnastics sanctioned competition.
- E. Meet Referee Penalties for Violations:
- A Meet Referee may receive a \$100.00 fine for failure to report a sanction violation on the sanction report form.
- F. Meet Director Penalties for Violations:
1. A meet director may receive the following penalties for violating any of the above stated violations.
    - a. A first time violation results in a fine of \$100.00 for one violation plus \$100.00 for each additional violation associated with the same sanction.
    - b. A second time violation results in a fine of \$500.00 for one violation. For each additional violation associated with the same sanction, the fine is \$500.00 each. In addition, a second-time violation may result in possible suspension of sanctioning privileges for the next competitive season, to be determined by the National Administrative Committee.
  2. Fines apply only to the individual and/or the Meet Director.
  3. Hosting institutions may also be denied sanctioning privileges if violations are repeated with multiple Meet Directors.
  4. The State Administrative Committee Chairman and/or Regional Administrative Committee Chairman will be notified of any violations by e-mail.
  5. If a fine is assessed to a Meet Director, but not paid by the deadline indicated, the ability to sanction an event will be denied until all balances are paid.
  6. If the violation is due to the lack of mandatory forms being returned, the ability to sanction an event will be denied until all mandatory forms are returned.
  7. If a fine is assessed but not satisfied by the deadline indicated, the Meet Director's membership may be placed in a pending status.
  8. Escalating penalties accrue during the current competitive season (August 1-July 31).
  9. If a Meet Director incurs three sanction violations in one competitive season, he/she will be placed in pending status. He/she must re-take and pass the Meet Director Exam before being placed in active status.
- G. Professional Member Penalties for Violations:
1. A professional member may receive the following penalties for violating any of the above stated violations.
    - a. A first time violation results in a fine of \$100.00.
    - b. A second time violation results in a fine of \$500.00.
    - c. A third time violation results in a fine of \$1000.00 and possibly suspension of membership.
  2. Fines apply only to the individual and/or the Meet Director.
  3. The State Administrative Committee Chairman and/or Regional Administrative Committee Chairman will be notified of any violations by e-mail.
  4. If a fine is assessed to a Professional Member but not paid by the deadline indicated, their membership will go into a pending status until all balances are paid.
  5. Escalating penalties accrue during the current competitive season (August 1<sup>st</sup>-July 31<sup>st</sup>)



#### IV. Sanction Report Forms

- A. An official USA Gymnastics Sanction Report Form is available online. To access the report forms, visit [usagym.org/pages/membership](http://usagym.org/pages/membership), 'My Sanctions'.
- B. **Keep a copy of the report form**, then e-mail, fax or mail pages 1-6 of the Sanction Report form plus all of the officials and coaches' sign-in sheet(s) to the USA Gymnastics Member Services department **within 72 hours**.
  - E-mail: [sanctions@usagym.org](mailto:sanctions@usagym.org)
  - Fax: 317-692-5212
  - Mail to: USA Gymnastics Member Services Department, 130 E. Washington St., Suite 700, Indianapolis, IN. 46204.
- C. Make copies of the Sanction Report Form and send them to the State Administrative Committee Chairman with the State competition fee (if applicable) within 72 hours.
- D. Applicable competition fees must be sent to the State/Regional Administrative Committee Chairman of the host state (based on physical location of the meet). See Chapter 3 Sanctions.
- E. **If an event is canceled, written notification must be submitted to USA Gymnastics Member Services prior to the start date of the event.** E-mail: [sanctions@usagym.org](mailto:sanctions@usagym.org) Fax: 317-692-5212.

## Chapter 4 - Meet Director Responsibilities

This is a summary of some of the responsibilities of the meet director. The meet director needs to be familiar with all sections of the *USA Gymnastics Rules and Policies* such as meet packet contents and the specifics for the meet if it is a State or higher meet. Also refer to the Meet Organizational Guidelines, which are posted online at <http://usagym.org/PDFs/Women/Rules/Rules%20and%20Policies/w-meetorguide.pdf>.

The USA Gymnastics Meet Director shall follow the *USA Gymnastics Rules and Policies* for all sanctioned events.

### I. Pre and During Meet Responsibilities

- A. It is the responsibility of the meet director to:
1. Mail the "Request for Sanction Form" a minimum of thirty (30) days prior to the meet to the USA Gymnastics Office, along with the sanction fee for all event requests (one form per event requested).
    - Requests received less than thirty days prior to the event will be assessed a late fee.
  2. The Meet Director(s) must also sign any contract required by the outside venue. The Meet Director may be a co-signer or an additional signer; however, a minimum of one signature must be the same on the sanction form and the venue contract.
  3. Be present during the entire warm-up and competition. It is permissible to indicate two meet directors by e-mailing [sanctions@usagym.org](mailto:sanctions@usagym.org).
  4. Follow all regulations found in the *Women's Program Rules and Policies* and all technical regulations from Women's Technical Committee minutes and the *Junior Olympic Code of Points*.
  5. Verify that all equipment specifications are correct, and the equipment is properly installed.
  6. Secure judges, which may be acquired through the designated and approved contractor. Level 1, 2, and 3, competitions may be judged by certified Skill Evaluators or certified officials. Contact your State Administrative Chairman for specific regulations for your state.
  7. Verify that gymnasts and coaches have included their Athlete or Professional Membership number on the entry form. (It is the coaches' responsibility to indicate the correct age division, level and citizenship.)
  8. Consider all reasonable safety measures when setting up the competition floor.  
EXAMPLES:
    - a. Each competitive area should not overlap with another competitive area.
    - b. There cannot be any obstructions on the Floor Exercise area.
    - c. There must be sufficient room for mounting, dismounting and vaulting areas.
  9. MEDICAL PERSONNEL/PROCEDURES:
    - a. For local/sectional meets, the Meet Director MUST provide a first aid kit and ice, as well as an organized plan for dealing with medical emergencies.
    - b. For State and Regional meets, it is strongly recommended that qualified medical personnel (physician, trainer, physical therapist, nurse, etc.) be available at all times during warm-ups and competition.
    - c. At Level 9 East/West Championships and Junior Olympic Level 10 National Championships, medical personnel must be present for all training and competition sessions.
    - d. It is recommended that a small first-aid kit (containing tape, gauze or Band-Aids) be provided at each event so these items can be accessed quickly.
    - e. An Incident/Injury Report Form is included in the Sanction packet and should be duplicated for use at the competition. Additional forms are available through Member Services and can also be found on the website under Member Services - Forms.
      - 1) The Meet Director must complete and sign the forms to the best of their ability before making a copy to return with the Sanction Report Form. The Meet Director will then supply the Incident/Injury Report form to the coach/parent/guardian of the injured athlete.
      - 2) The medical personnel (if present) may complete the portion of the form documenting the injury before the Meet Director signs it.
- B. The meet director must be thoroughly versed in the organization and regulations of gymnastics competitions. Any meet director who violates any regulations of the *Rules and Policies* will be subject to disciplinary action.

## Chapter 4

- C. Upon receipt of the "Request for Sanction Form" and appropriate fee, the USA Gymnastics Member Services department will make available online a sanction packet which includes the following:
1. Certificate of Sanction, granting approval. This certificate must be posted during the competition.
  2. Sanction Report Form
  3. Coaches' sign-in sheet
  4. Application for a Certificate of Insurance (for events conducted in an outside facility which requires proof of insurance.) The Meet Director must forward this application directly to the insurance company.
  5. Incident and Injury report form is a document, which must be completed in the event that an athlete is injured. The Meet Director and/or medical personnel must complete the report form. The Meet Director must sign it. A copy of the report form must be given to the coach or parent of the injured athlete before they leave the sanctioned facility. The parent then must submit it to the insurance company. The insurance company will not honor an incident/injury report form that has NOT been signed by the official Meet Director.
- D. Request for changes to original Request for Sanction:
1. To change the name of the Meet Director or the date of the event, submit a request in writing to [sanctions@usagym.org](mailto:sanctions@usagym.org) (or by Fax: 317-692-5212) prior to the start of the event.
  2. If a Certificate of Sanction is received prior to the change, the Meet Director must make the changes on the certificate. A new certificate will NOT be issued.
- E. Ensure that all participating officials and coaches have signed the Sanction Report Form and/or Coaches Sign-in sheet.
- F. Ensure the event uses the online meet reservation system to record coaches, clubs, athlete and judges.
- G. If an event is canceled, written notification must be submitted to USA Gymnastics Member Services prior to the start date of the event. E-mail: [sanctions@usagym.org](mailto:sanctions@usagym.org) Fax: 317-692-5212.
- H. Awards for state meets and above are ordered by a USA Gymnastics elected officer. For all other meets, it is the responsibility of the Meet Director to order awards as designated in Chapters 7 and 9.
- I. Meet directors must provide options to play only digital copies of music (MP3 players, computers, tablets, smart phones, etc.) and are no longer required to provide compact disc players. The electronic devices provided by the coach must have a display screen and must be on airplane mode, when applicable.

## II. Meet Director Responsibilities Regarding Judges

- A. The USA Gymnastics Meet Director will not pay fees that exceed the USA Gymnastics Judges Compensation Package for payment of judges at any sanctioned competition.
- Meet Directors/host organizations may give gifts to meet officials. The gift cannot exceed a retail value of \$20.00.
- B. If so designated by the State/Regional Administrative Committees, the USA Gymnastics Meet Director MAY utilize the NAWGJ as the contracting body for officials for USA Gymnastics Sanctioned Meets.
- The Meet Director is required to pay a contractor's fee of \$3.00 per contracted judge to the NAWGJ contractor. A Request for Judges Form that is received by the Contractor within 30 days of the competition will be charged \$5.00 per judge.
- C. Compensation will be paid directly to the individual judge.
- D. In the event that the USA Gymnastics Meet Director fails to comply with the terms of the sanction or the USA Gymnastics *Rules and Policies*, judges may refuse to perform any judging obligations. However, all/both parties should make every immediate attempt/effort to resolve any disputes, in keeping with the best interest of the athletes involved. No such action should ever be taken that would jeopardize or compromise the safety or wellbeing of the athlete.
- E. The Meet Director will be bound by the terms of the individual contract agreed upon for that particular meet.
- F. A minimum 30-minute break is required for judges between scheduled sessions.

## III. Post-Meet Responsibilities

- A. Distribution of Results: Meet results must be distributed to ALL participating clubs. This can be done at the meet site, by mail, or by posting on the Internet. Published results MAY NOT include the gymnast's date of birth. In addition, the Meet Director MUST mail or e-mail a copy of the Meet Results (All-Around and individual event scores for each level and age division) within 72 hours to:
1. For Local Meets
    - a. State Administrative Committee Chairman, or designated State Administrative Committee representative.

## Chapter 4

- b. Meet Director of the Pre-Sectional, Sectional or State Meet, depending upon the system of qualification.
2. For Pre-Sectional Qualifiers or Sectional Meets
    - a. State Administrative Committee Chairman, or designated State Administrative Committee representative.
    - b. Sectional or State Meet Director, depending upon the system of qualification.
  3. For State, Regional, Eastern/Western, National, and NIT championship meet, see the meet specifics for each type of competition.
- B. Reports
1. Financial Reports: The Meet Director of State and above level meets must send a completed Financial Report form within 60 days (or otherwise designated time) to the designated person - see meet specifics.
    - Report forms can be found at the USA Gymnastics website:  
<http://usagym.org/PDFs/Women/Rules/Rules%20and%20Policies/w-meetorgguide.pdf> or from the State Administrative Committee Chairman
  2. Sanction Reports: Complete and return the Sanction Report Form including the Coaches and Officials Sign-in sheets along with copies of any Incident/Injury Report Forms to the USA Gymnastics Member Services Department and the appropriate Regional/State Administrative Committee Chairman within 72 hours.
    - Applicable competition fees must be sent to the State/Regional Administrative Committee Chairman of the host state (based on physical location of the meet). See Chapter 3, Sanctions.

## Chapter 5 - Meet Officials

Consistent with the provisions of the Amateur Sports Act of 1978, the United States Olympic Committee has designated USA Gymnastics as the national governing body for the sport of gymnastics in the United States. As reflected in its Articles of Incorporation and its conduct under those Articles, USA Gymnastics' responsibilities for governing the sport of gymnastics include the regulation of matters relating to the training, testing, certification and assignment of judges for gymnastics competition conducted or sanctioned by USA Gymnastics.

Please review the Duties and Responsibilities for Professional Members in Chapter One.

### I. Contracting of Officials

In order to ensure properly rated officials at all sanctioned events, officials may be contracted through a designated and approved contractor.

- A. State Administrative Committees shall determine their officials' contractor and/or assignor to be used for meets that are conducted under the organizational jurisdiction of the State Administrative Committee.
- B. Regional Administrative Committees shall determine their officials' contractor.
- C. USA Gymnastics criteria for selection of officials must be followed.
- D. The Meet Director must complete a "Request for Judges" form and send it to the Contractor, with payment of a maximum of \$3.00 for each official contracted, by the deadline designated by the State Administrative Committee.
  - If the request is received less than 30 days prior to the competition, the fee is a maximum of \$5.00 for each official contracted. Assignments for such late requests will be based on availability, since there may not be a sufficient number of certified officials available. Forms can be found on the USA Gymnastics web site or contact the State Administrative Committee Chairman.
- E. The USA Gymnastics Judges' Compensation Package will be used at all sanctioned competitions, with the exception of the judging fees for Xcel competitions that have an entry fee of \$35.00 or less. (Refer to Xcel Judging Guidelines.)
- F. Meet hosts of Invitational competitions or any meets that are not under the organizational jurisdiction of the State Administrative Committee may use the state-approved contractor or may contract the officials directly using a USA Gymnastics contract.
  - The Meet Director may also request specific judges (by name or by ratings) when they submit a "Request for Judges" form to the state approved contractor. The Request for Judges Form is available on the USA Gymnastics website under Women's Program – Forms – Meet Forms or from the State Administrative Committee Chairman or the NAWGJ State Judging Director.

### II. Affiliation of Judges

The regulations regarding affiliation are NOT meant to prevent officials from judging, but to prevent unfair situations for the gymnasts.

- A. Affiliation of judges with an individual(s) or gymnastics club:
  1. A judge is considered affiliated at a specific meet if he/she is:
    - a. An immediate family member\* of a:
      - 1) competing gymnast
      - 2) coach of a competing club
        - A judge whose immediate family member is a coach at a competing club is affiliated with that club regardless of whether or not the family member is on the floor coaching at a specific meet.
      - 3) club owner/administrator whose **club** is competing
      - 4) Women's Artistic (JO or Xcel) team member of a club competing in the meet.  
Example: A parent of a Level 5 gymnast is judging an Optional competition in which her daughter's club is competing.
        - a) An immediate family member of a Men's, Rhythmic, Acrobatic Gymnastics, or Tumbling/Trampoline Team member of a competing club is NOT considered to be affiliated.
        - b) An immediate family member of any child enrolled in a recreational class of a competing club is NOT considered to be affiliated.
    - \* Immediate family refers to a parent, step-parent, grandparent, or sibling. In addition, it could include any other person living in the household.
  - b. A person on the payroll of a competing club.
    - A judge who critiques or coaches at a specific gymnastics club on a regular (more than once a month) basis is considered affiliated with that club.

## Chapter 5

- c. A Women's Artistic (JO or Xcel) team member of a club competing in the meet.
    - Example: A Level 10 gymnast holds a Compulsory rating and is judging gymnasts from her own club at a Compulsory meet.
  - d. A Coach of a competing gymnast.
  - e. A Club Owner of a competing club/gymnast.
  - f. Any sports science professional that is paid for ongoing services for a competing athlete.
    - Example: Athletic Trainer, Physical Therapist, Sports Psychologist
2. Judges affiliated with a club, gymnast or coach participating in the competition MAY be assigned to judge, with the following stipulations:
    - a. In USA Gymnastics qualifying competitions with panels of two (2) or four (4) judges:
      - 1) An affiliated judge may be assigned as a Panel judge or as the Meet Referee.
      - 2) No more than one (1) judge with the same affiliation may be assigned per panel.
      - 3) An affiliated judge may NOT be assigned as Chief Judge, regardless of accreditation rating.
    - b. In non-qualifying Open Invitationals with panels of two (2) or four (4) judges:
      - 1) Affiliated judges may be assigned as a Chief or Panel judge.
      - 2) If any of the Chief Judges are affiliated, the Meet Director must list the judges (and their affiliation) on the pre-meet information.
    - c. For meets using one-judge panels, an affiliated judge may be assigned ONLY when there are not enough non-affiliated judges available and only with the approval of the Regional Technical Chairman (RTCC).
      - 1) If the RTCC is affiliated and must be assigned, approval must come from the State Administrative Committee.
      - 2) An affiliated judge may be assigned to a one-judge panel for Level 1 and 2.
    - d. If the club with which the judge is affiliated is not participating in the meet to which the judge has been assigned, he/she is NOT considered affiliated at that meet.
      - 1) If the meet format has separate team and individual awards per session, then a judge would be affiliated only during the session(s) in which the club/team that he/she is affiliated with is competing.
      - 2) If there is an overall team award for the same levels at the end of the entire meet, the affiliation rules apply for the entire competition.

### III. Criteria for Selection of Judges to Women's USA Gymnastics Competitions

- A. General Policies and Procedures at Junior Olympic Competitions
  1. The Technical Committee establishes the criteria for selection of judges to Junior Olympic competitions. Infractions should be brought to the attention of the Regional Technical Committee Chairman and/or the National Technical Committee Chairman for appropriate action.
  2. All assignment of judges will be made according to the *USA Gymnastics Rules and Policies*, USA Gymnastics Technical Committee criteria for selection and the philosophy as defined herein.
  3. The State Administrative Committee selects the Meet Referee and the officials for State Championships. Chief Judge and Panel Judge assignments to specific events at State and Regional Championships are the responsibility of the State or Regional Administrative Committees. It is strongly recommended that the State Administrative Committee and the Regional Administrative Committee ask the assigned Meet Referee to make the Individual Event Assignments. At local, pre-sectional and sectional meets, the assigning official may make the event assignments. Criteria for assignment of judges must be followed.
    - When designating the Chief Judge positions for sanctioned competitions, rating and longevity do not necessarily determine assignment as Chief Judge. Reference the chart later in this chapter for minimum rating required.
  4. The Regional Administrative Committee selects the officials for the Regional Junior Olympic competitions, with the approval of the RTCC, and in consultation with the Regional Administrative Committee Chairman.
    - a. The State Administrative Committee must submit their recommendations in rank order (or groups in rank order) to the RTCC.
    - b. Rotation of officials is not required but may be considered.
    - c. The Regional Technical Committee Chairman, if unavailable, selects the Meet Referee, in consultation with the Regional Administrative Committee Chairman.
  5. Level 9 Eastern/Western Championships and Level 10 Junior Olympic National Championships assignments will be made by the National Technical Committee Chairman, in consultation with the Junior Olympic Technical Director after reviewing the regional recommendations as well as financial considerations.
    - a. The Regional Technical Committee Chairman must submit their Regional Administrative Committee's recommendations in rank order (or groups in rank order) to the National Technical Committee Chairman (with a copy to the Women's Junior Olympic Technical Director) no later than November 1.
    - b. Rotation of officials is not required but may be considered.

## Chapter 5

6. Geographical representation is not required but may be considered in all selection of officials. (See specific competitions).
7. It is permissible to assign judges from adjacent or neighboring states and/or regions, if necessary, in order to obtain the desired number and appropriately rated judges at minimal cost.
8. In order to be considered for an assignment, all judges must be:
  - a. Current USA Gymnastics Women's Professional or Junior Professional members. Membership requires a current Safety Certification and, for those individuals who are 18 years and older, a criminal background check and U110 Safe Sport Training.
    - The State Administrative Committee determines the judging criteria for Levels 1-3 and the Xcel Program.
  - b. Certified and actively judging at the level of meet to which they are assigned.  
In the event that all local judges with the proper rating have been asked and there are not enough properly rated officials available to judge on a specific date, and the format of that local or sectional meet cannot be adjusted to allow the gymnast to be judged by properly rated officials, the assignor uses the following guidelines to assign the meet:
    - 1) Notify the Meet Director and give them the option of securing properly rated judges from outside their geographic area (or state).
    - 2) If the above option is not financially feasible, the assignor must notify and receive approval from the RTCC to assign a judge at the next lower level, giving priority to the following:
      - 1<sup>st</sup> – a judge who has taken and passed one part of the accreditation exam for the next level
      - 2<sup>nd</sup> – a judge who has taken the next level exam, but has not yet passed either part
    - 3) It is recommended that any judge assigned to judge a level higher than the rating held should be assigned to Vault.
    - 4) Compulsory meets: Current optional-rated judges are allowed to judge compulsory Vault **ONLY IF** there are not enough available compulsory-rated judges, provided that the RTCC has given permission.
  - c. Maintain USA Gymnastics Continuing Professional Education requirements annually; see chart.
    - 1) If a judge has not completed his/her CPE requirements by July 31<sup>st</sup>, he/she CANNOT BE ASSIGNED to any USA Gymnastics sanctioned competition until such time that they submit the completed Annual CPE form.
    - 2) Some states may experience difficulty in securing enough officials who are current with CPE requirements in order to staff a specific competition. If there is an absolute necessity to assign a judge who is delinquent in completing his/her CPE requirements, the judge may be assigned; however, that judge's compensation will be reduced by \$5.00 per hour.
  - d. Priorities for assignors after August 1 of each year:
    - 1) Assign properly rated judges
      - a) First, those who have completed annual CPE requirements.
      - b) Second, if not enough of the above are available, assign those who have not yet met their CPE requirements.
    - 2) Only after all possibilities of the above have been exhausted, may the assignor request permission from the RTCC to allow a judge with one rating lower to be assigned.
  - e. Holding a specific rating does not insure a judging assignment. Once the availability of judges has been established, the assignors must consider:
    - 1) Requests by the Meet Director for specific judges or specific ratings.
    - 2) The minimum rating required to judge the specific meet.
    - 3) Geographical location of the meet. Attempts should be made to keep the travel costs at a minimum for the Meet Director.
- B. "Judges' Accreditation" is the name applied to the certification process and the process will be a part of the USA Gymnastics University. The "Continuing Professional Education (CPE)" system will be implemented as listed below:
  1. Annual CPE credits are required to be assigned to judge any USA Gymnastics competition.
  2. The accreditation year is August 1-July 31. Credits earned during the months of June and July may be used for the current or upcoming accreditation year.
  3. CPE credits will be calculated in actual clock hours (hours involved in the activity).
  4. The rating a judge holds on July 31 of each year determines the number of CPE hours required for that accreditation year. Entry level judges attaining their rating after the start of the accreditation year are not required to report CPE hours until the following accreditation year. All CPE hours accumulated during that time may be used to fulfill the CPE requirements.Examples:
  - a. If an individual achieved a Compulsory rating for the first time prior to August 1, the CPE requirements are due by May of the following year. If this individual upgrades their rating to 6/7/8 after August 1, they are only required to fulfill the CPE hours required of a Compulsory rated judge, as that was their rating as of July 31.

## Chapter 5

- b. If an individual achieved a Compulsory rating for the first time on or after August 1, 2019 the CPE requirements are not due until May of 2021, since he/she had no rating as of July 31, 2019.
5. USA Gymnastics and NAWGJ elected officers (State, Regional and National Chairman/Directors) are exempt from CPE requirements for the years in which they hold office. Also exempt are USA Gymnastics Women’s Program National office staff and National Coaching staff.
- Above mentioned elected officers also receive full credit for the 12 required volunteer hours for the USA Brevet and National Judges’ Course eligibility.

6. **Annual Required CPE hours are as follows:**

Highest Rating Held	Total CPE hours needed per Accreditation Year	Minimum # of Clinic CPE Hours required as part of the yearly total	Maximum # of CLINIC hours allowed to carry forward to the next Accreditation Year after the annual total has been met.
Level 4/5	12 hours	6 hours	2 hours
Level 6/7/8	12 hours	6 hours	2 hours
Level 9	16 hours	8 hours	3 hours
Level 10	20 hours	10 hours	4 hours
National	20 hours	10 hours	4 hours
Brevet	20 hours	10 hours	4 hours

- a. CPE Clinic Hours are those hours spent:
- 1) At a State, Regional, or National organized events, such as Congresses, Clinics, Courses or Symposiums. These events must be publicized in advance and open to all judges in the state, region, or nation as applicable to the event. (Exception: eligibility requirement must be met for judges’ courses.) Judging or coaching sessions will be designated as “approved for CPE”.
    - Clinicians also receive Clinic hour credits when teaching at such events. Clinicians at Regional or National educational events receive an additional 2 credit-hours for preparation time for every one hour of lecture.
  - 2) CPE Clinic hours may also be earned for attending LIVE USA Gymnastics webinars that have been approved by the Technical Committee, as well as for completing USA Gymnastics University Online Judges Courses.
    - A maximum of one-half of the annual required clinic hours may be earned by online courses per accreditation year.
    - If extra hours are accumulated from these online educational opportunities, they may be applied as miscellaneous credits.
  - 3) Judges should retain their CPE clinic forms for documentation, with a copy of the Annual Report Form.
- b. All clinics eligible for CPE Clinic credit require pre-approval from the appropriate State or Regional USA Gymnastics and NAWGJ officers by submitting the Clinic Approval Form a minimum of three weeks prior to the clinic. USA Gymnastics and NAWGJ officers must return a copy of the signed Clinic Approval Form to the USA Gymnastics National office. All CPE-approved clinics require a sanction and once submitted to the National office, are posted on the Judges home page, select CPE Clinics.
- c. It is the responsibility of each judge to pre-print the CPE Clinic Credit form prior to attendance at a pre-approved clinic session. Judges must present the Clinic CPE Credit form for a signature at the conclusion of the clinic or following each session at multi-track Congresses/Symposiums. Clinical CPE activities are to be recorded on a Clinic CPE credit form, which can be found online under Women’s Program-Judges-Judges’ Accreditation forms.
- d. Annual Miscellaneous CPE credit: A maximum number of CPE hours may be acquired for the following miscellaneous activities:
- 1) Coaching (6 hours) to be signed by supervisor or club owner.
  - 2) In-gym observation or **in-gym** critiquing/consulting with coaches and gymnasts (6 hours), to be signed by the coach.
    - Attendance at state/regional/national training camps may be used as miscellaneous credit–hours; however, if there is a clinician who is specifically assigned to the judges and has an organized agenda for instruction, it may be used for clinic-hours.
  - 3) Volunteering (4 hours) at a judging-related activity such as a competition or at a USA Gymnastics Congress or clinic. CPE form must be signed by the event coordinator, Meet Director, or Meet Referee. Two of these four hours can come from service as a USA Gymnastics Committee member or NAWGJ Board member.



## Chapter 5

- 4) Video or live practice judging at a level equal to or higher than your current level (3 hours) Practice judging will require pre-approval from the SJD and/or USA Gymnastics State Administrative Chair. For pre-approval, simply send an e-mail to the appropriate officer requesting permission. Please note that live Practice Judging will also require pre-approval from the Meet Director. This is done by contacting the Meet Referee for the event, not the Meet Director. The practice judge should come prepared with all judging materials and wear the appropriate judging uniform. Video Practice Judging will be recorded in hours and requires written verification from the supervising judge.
  - 5) Miscellaneous CPE activities are to be recorded on the Miscellaneous CPE Credit form, which can be found online under Women's Program-Judges-Judges' Accreditation forms.
7. Continuing Professional Education Tracking:
- a. Each judge is responsible for keeping accurate records of his/her CPE activity, including documentation of attendance at the approved CPE experiences. Documentation should correspond to the hours submitted on the Annual CPE Record form.
  - b. The USA Gymnastics State Administrative Committee Chairman will be responsible for designating a USA Gymnastics CPE Coordinator for their state. CPE Coordinators must be proficient in Excel spreadsheets. The CPE Coordinator will maintain a list of all judges in the state, the number of CPE hours they completed each year, and the number of clinical hours they will carry forward to the next year.
  - c. Each judge is responsible for recording a summary of their total annual CPE hours by category, recorded on the Annual CPE Record form, and submitting their form to their respective CPE Coordinator by May 31 of each year. The Annual CPE Record form is available online under Women's Program-Judges-Judges' Accreditation forms or may be obtained from the state CPE Coordinator.
  - d. The CPE Coordinator is responsible for sending a master list of all judges in their state, indicating those who have successfully completed their annual CPE requirements to the JO Technical Director at the USA Gymnastics national office, their respective SJD, RJD, and USA Gymnastics State Administrative Committee Chair, Regional Technical Committee Chair, and Regional Administrative Committee Chair by June 30<sup>th</sup> of each year.
  - e. If a judge does not complete all of their required CPE hours within a given accreditation year, they must apply CPE hours from the successive year to make up for the hours they were lacking. When completed, they must still send the proper documentation to their CPE Coordinator, who then sends an updated list to the National Office and their respective State and Regional officers.
    - Note that CPE hours cannot be used twice, meaning if hours are being used to make up for a deficit in the previous accreditation year, those same hours cannot not be applied to the current accreditation year as well.
  - f. The National Office will conduct audits each year that will require randomly selected judges to submit actual documentation of their CPE, as reported to the CPE Coordinator, to the USA Gymnastics National office. Any judge who fails to provide documentation of actual CPE hours as reported will be subject to disciplinary actions as stated in Article 9 of the USA Gymnastics Bylaws.
  - g. Should a judge exceed the total minimum number of CPE hours required of their rating in an accreditation year, and the excess is in the category of Clinic Hours, they may carry forward the excess Clinic hours up to the maximum number of carry-over clinic hours allowed as designated by their rating. Excess miscellaneous hours may not be carried over.

Example: A National judge is required to earn a TOTAL of 20 total CPE hours, 10 of which MUST be Clinic hours

    - 1) Earns a total of 24 CPE hours: 14 Clinic hours and 10 Miscellaneous hours – There is an excess of 4 clinic hours beyond the required 20 hours, so 4 clinic hours may be carried over.
    - 2) Earns a total of 20 CPE hours: 12 Clinic hours and 8 Miscellaneous hours for the minimum 20 hours required of that rating. No carry-over of Clinic hours is possible since the total number of required hours for that rating has not been exceeded.
- C. Junior Olympic Competitions
- ALL JUDGES FOR THE FOLLOWING COMPETITIONS MUST POSSESS A CURRENT JUDGING CERTIFICATION AT THE LEVEL TO WHICH THEY ARE ASSIGNED. All judges assigned to the Junior Olympic State, Regional, Eastern/Western and National Championships shall have been actively judging within the corresponding Junior Olympic Level (Compulsory or Optional) during the competitive season and shall be current Professional (or Junior Professional) Members of USA Gymnastics with current Safety/Risk Management Certification and, for those who are 18 years and older, a Criminal Background Check and U110 Safe Sport Certification. In order to be assigned to a sanctioned competition, all judges must be current with all USA Gymnastics Continuing Professional Education (CPE) requirements.

Chapter 5

**COMPULSORY LEVELS**

	MINIMUM RATINGS REQUIRED FOR ASSIGNMENT AS:			Minimum # Judges Per Panel	Geographic Representation
	Meet Referee	Chief Judge	Panel Judge		
<b>Level 1-3</b>					
<b>Local</b>	Level 4/5 ---- Criteria determined by SAC	Level 4/5 ---- Criteria determined by SAC	Level 4/5 ---- Criteria determined by SAC	1 (# and minimum criteria for 1-judge panel determined by SAC)	
<b>Pre-Sectional/ Sectional</b>	Level 4/5 Criteria determined by SAC	Level 4/5 Criteria determined by SAC	Level 4/5 Criteria determined by SAC	1 (# and minimum criteria for 1-judge panel determined by SAC)	
<b>State</b>	Level 6/7/8 and 4/5 Criteria and selection determined by SAC	Level 4/5 Criteria determined by SAC	Level 4/5 Criteria determined by SAC	2	(determined by SAC)
<b>Level 4</b>					
<b>Local</b>	Level 6/7/8 and 4/5	Level 4/5	Level 4/5	1 (if 1 judge panel- min. 4/5 w/ min. of 1 yr. experience)	
<b>Pre-Sectional/ Sectional</b>	Level 6/7/8 and 4/5	Level 4/5	Level 4/5	1 Determined by SAC: If 1-judge panel - min. 4/5 w/ min. of 1 yr. experience	
<b>State</b>	Level 6/7/8 and 4/5 Selected by SAC	Level 4/5	Level 4/5	2 or 4 Determined by SAC	Determined by SAC
<b>Level 5</b>					
<b>Local</b>	Level 6/7/8 and 4/5	Level 4/5	Level 4/5	1 or 2 (1 judge panel allowed if not a state qualifier - must be min. 4/5 w/ min. of 1 yr. experience)	
<b>Pre-Sectional/ Sectional</b>	Level 6/7/8 and 4/5	Level 4/5	Level 4/5	2	
<b>State</b>	Level 6/7/8 and 4/5 Selected by SAC	Level 4/5	Level 4/5	2 or 4 (determined by SAC)	(determined by SAC)

Chapter 5

OPTIONAL LEVELS

	MINIMUM RATINGS REQUIRED FOR ASSIGNMENT AS:			Minimum # Judges Per Panel	Geographic Representation
	Meet Referee	Chief Judge	Panel Judge		
<b>Level 6/7</b>					
<b>Local/ Pre-Sect. /Sectional</b>	Level 9	Level 6/7/8	Level 6/7/8	2	
<b>State</b>	Level 9 Selected by SAC	Level 9	Level 6/7/8	2 or 4 (determined by SAC)	(determined by SAC)
<b>Level 8</b>					
<b>Local/ Pre-Sectional/ Sectional</b>	Level 9	Level 6/7/8	Level 6/7/8	2	
<b>State</b>	Level 9 Selected by SAC	Level 9	Level 6/7/8	2 or 4 (determined by SAC)	(determined by SAC)
<b>Regional</b>	RTCC, or Brevet or National Must have served as MR or CJ at L. 8, 9 or 10 Sectional or State	Level 9	Level 6/7/8	2 or 4 (determined by RAC)	(determined by RAC)
<b>Level 9</b>					
<b>Local/ Pre-Sectional/ Sectional</b>	Level 10	Level 9	Level 9	2	
<b>State</b>	Level 10 Selected by SAC	Level 10	Level 9	2 or 4 (determined by SAC)	(determined by SAC)
<b>Regional</b>	RTCC, If not available, then other Brevet or National Must have served as MR or CJ at L.9 or 10 Sectional or State	Level 10	Level 9	2 or 4 (determined by RAC)	(determined by RAC)
<b>East/West</b>	RTCC, or other Brevet selected by NTCC; Must have served as MR or CJ at L. 9 or 10 Reg'l or State	National  Must have served as MR or CJ at L. 9 or 10 Reg'l or State	Level 10 or above; Must have judged a L. 9 or 10 Local, Sect., State or Reg'l	4	a min. of 3 per region; no more than 2 per region on same panel
<b>Level 10</b>					
<b>Local/ Pre-Sectional/ Sectional</b>	Level 10	Level 10	Level 10	2	
<b>State</b>	Level 10 Selected by SAC	Level 10	Level 10	2 or 4 (determined by SAC)	(determined by SAC)
<b>Regional</b>	RTCC, If not available, then other Brevet or National Must have served as MR or CJ at L. 10 Sect. or State	National  With approval of RTCC	Level 10	2 or 4 (determined by RAC)	(determined by RAC)
<b>JO Nationals</b>	NTCC plus 1 Brevet selected by NTCC; Must have served as MR or CJ at L. 10 Reg'l or State	National Must have served as MR or CJ at L. 10 Reg'l or State	National Must have judged a L.10 Local, Sect., State or Reg'l	4	4 judges per region (2 for Junior and 2 for Senior 2 East and 2 West regions on each panel

## Chapter 5

### D. Selection for Elite Competitions

1. The Judges' Selection Committee (JSC) is responsible for judge's assignments to Elite National Competitions (Classics, Championships, Olympic Trials, Pan American Trials, and World Championship Trials), as well as International judging assignments. The Judges' Selection Committee consists of the National Team Coordinator, International Elite Committee Chairman, and a FIG Brevet Judge appointed by the IEC.
2. All Elite National competitions (National Qualifying Meets, Classics, Championships, Olympic Trials, Pan American Trials, and World Championship Trials) and Hopes Classics and Championships are under the technical jurisdiction of the USA Gymnastics National Office and the International Elite Committee.
3. All judges for Elite and Hopes Optional competitions must hold a current FIG-Brevet rating. Judges assigned to a Compulsory National Qualifying meet must hold a current FIG or USA Gymnastics Brevet rating (and be in the selected pool of USA Brevets).
4. Judges for Elite Compulsory Competitions at National Qualifying meets:
  - a. A minimum of 50% of the judging panel(s) must come from the pool of selected FIG-Brevet officials established by the International Elite Committee (IEC).
  - b. FIG-Brevet judges (not in the selected pool) and/or USA Gymnastics-Brevet judges (from the selected pool) may be also assigned if additional judges are needed.
5. Judges for Optional Competition at National Qualifying meets:
  - a. All judges must come from the pool of selected FIG-Brevet officials established by the International Elite Committee (IEC).
  - b. Judges for National Qualifying meets conducted by the National office will be assigned by the Judges Selection Committee.
  - c. Judges for National Qualifying meets conducted in conjunction with Invitational competitions will be selected by the Meet Director, according to the guidelines established by the IEC and with the approval of the USA Gymnastics Senior Vice-President of Women's Program.
6. USA Championships/Classic Competitions:
  - a. All judges must come from the pool of selected FIG-Brevet officials established by the International Elite Committee (IEC).
  - b. Selection and event assignments will be made by the Judges Selection Committee.
  - c. Technical questions will be addressed by the Senior Vice-President of Women's Program, the Chairman of the International Elite Committee or their designated replacement.
  - d. A Video Review Panel will be used for Classic and above competitions and will be comprised of experts selected by the International Elite Committee.

### **IV. Duties of Meet Officials – See the *Women's Junior Olympic Code of Points***

## USA Gymnastics Judge's Compensation Package

(EFFECTIVE AUGUST 1, 2019- JULY 31, 2020)

### I. Non-judging Compensation

#### A. Judges Report Times and Fines

1. Judges MUST report to the judges' meeting/hospitality room 30 minutes prior to the scheduled march-in for local and invitational competitions, unless otherwise specified by the Meet Referee. Judges' compensation will begin at the scheduled report time. Any official who does not report within five (5) minutes of the scheduled report time will be compensated from the first scheduled march-in time.
2. Reporting time for those competitions requiring video analysis may be up to one (1) hour prior to march-in. The Meet Referee will specify the reporting time.

#### B. Travel

1. The standard IRS rate will be paid for the entire round-trip mileage for all drivers, including those who drive to meet a carpool. Judges must submit printed MapQuest-type documentation in order to be reimbursed for mileage.
  - Any increase or decrease in the IRS mileage fee will only be recognized and used when the increase or decrease is a full cent. Less than a full cent increase/decrease will not be recognized. IRS mileage rate changes are announced in December of each year and will be posted on the USA Gymnastics website, with the new rate effective in January.
2. Riders' fees are not paid.
3. Plane, train or bus travel expenses as stated on the contract shall be paid in full by the Meet Director. The total mileage cost should not exceed the cost of an airline ticket to the same location if the Meet Director requests that the judge purchase their own airfare or other means of travel.
  - a. If the judge requests to drive, instead of fly, the Meet Director must determine the cost of the airline ticket and communicate that information to the judge in order for the judge to be aware of the maximum reimbursement.
  - b. If the Meet Director requests that the judge purchase their own airfare or other means of travel, the judge must communicate the cost to the Meet Director for approval prior to finalizing travel plans.
4. Mileage to and from the airport, tolls, airport parking, fees for one bag (but not overweight bag charges), taxi or limousine service as stated on the contract shall be paid by the Meet Director. These expenses must be listed on the contract and be approved by the contracting official in order to be compensated by the Meet Director. Only standard and customary expenses with accompanying receipts will be reimbursed in the actual amounts.
5. For competitions that span over two or more days and:
  - a. Overnight accommodations are not necessary, round-trip mileage will be paid for each day.
  - b. Lodging is provided to the judges by the Meet Director:
    - 1) If a judge chooses to return home and drive back the second (and successive) days, round-trip mileage will be paid only once, unless pre-arrangements have been made with the contracting official and the Meet Director.
    - 2) When calculating mileage for meets requiring overnight accommodations, include printed MapQuest-type documentation of the total miles from home to hotel, to and from competition venue, and return to home.
6. No other expenses (such as baby-sitters, car repairs, car rental, reimbursement for lost salary, or other normal work-related expenses) will be paid.

#### C. Lodging

1. If a judge must stay overnight prior to, during or following the competition, lodging must be provided and paid for by the Meet Director.
2. The form of accommodation must be specified in the judge's contract. Accommodations based on double occupancy in a room must provide two beds, which cannot include a sleeper sofa. Meet Directors may consider single room assignments for judges.
3. Whenever there is an early-morning report time and/or a late finish time, it is recommended that the Meet Director provide the option for the judges to stay at a hotel. Distance and/or weather conditions should be considered.

#### D. Per Diem

1. Meet Directors may either provide judges' meals or pay per diem, according to type of meet listed below.
  - a. Meals provided by the Meet Director should be nutritional and not just concession type food.
  - b. Judges with dietary restrictions should bring their own food.
  - c. It is inappropriate for a judge to provide his/her family with meals in (or from) the judges' hospitality area.
2. Day (Local) Meets
  - a. No per diem will be paid (or meals provided) for competitions that require the judge to be at the meet site for less than 3 hours, unless round trip mileage is 100 miles or more. These rates are determined regardless of departure or arrival time to the judge's home.

## Chapter 5

- b. Per Diem compensation should be paid to the judges at a rate of:
    - 1) \$15.00 Diem - When on-site responsibilities are at least 3 hours but less than 8 hours. (Time begins with reporting time to include meetings and competition.)
    - 2) \$30.00 Diem - When on-site responsibilities are 8 hours or more. \$15.00 per meal (up to a maximum of \$30.00 per day) is assessed for any meals not provided by the Meet Director.

Clarification: Reimbursement for breakfast is not considered for day (local) meets which the judge travels to and from the meet site in one day.
  3. Overnight Meets
    - a. All meals not provided by the Meet Director are compensated at a rate of \$15.00 per meal, with a maximum of \$40.00 per day. Per diem or provided breakfast is required for only judges with an overnight stay.
    - b. Guidelines for meals the night before the competition begins.
      - When the judge arrives at or before 5:00pm the day before the competition begins, a \$30.00 per diem is required. If the judge arrives at or after 5:01pm the day before the competition, a \$15.00 per diem is required.
    - c. Guidelines for meals at the conclusion of the competition.
      - The Meet Director **MUST** include the information regarding meals provided at the conclusion of the competition in the contract.
- E. Modifications
1. If any conditions on the contract are altered, it is the responsibility of the Meet Director to contact the individual judge(s) and the **CONTRACTING OFFICIAL** and provide that information to **BOTH**. Additional days or sessions are considered "non-contractual" and could result in the judge voiding the contract.
    - Additional assigning fees of \$1.00 per judge may be charged by the contracting official if called upon to notify the judges of any changes.
- F. Cancellation
1. If the contract obligations are not fulfilled by either party because of extenuating circumstances, no mandatory penalties will be applied to either party. Example: Inclement weather (prohibiting travel) or grave illness.
    - When inclement weather exists (weather which delays or prohibits safe travel for the judges), the Meet Director is responsible for the judges' lodging and meals. Judges will be accommodated with minimal expense and could be lodged in private homes with food provided. Hotel/Motel rooms are compensated **ONLY** if approved by the Meet Director.
  2. Failure to comply with the contractual agreement will result in the following:
    - a. On the Meet Director's part:
      - 1) A minimum of 14 days' notice is required for amendments or cancellation of officials. If cancellation of officials occurs less than fourteen days prior to the meet and the officials are not re-assigned to another competition, the Meet Director is responsible for payment of 2 hours honorarium per judge and any non-refundable expenses incurred.
      - 2) Regardless of the timing of the cancellation of the meet, if the judge has purchased a non-refundable airline ticket, the meet director is responsible for reimbursing the judge for the "change fee" charged by the airlines to use the ticket for a future flight. In order to receive future credit for the cancelled flight, the judge must contact the airlines **PRIOR TO THE SCHEDULED DEPARTURE** to cancel the originating flight and must rebook a flight within one year of the **DATE OF ISSUE** of the original ticket by providing the ticket number. If the ticket is not cancelled prior to the scheduled departure, it becomes null and void.
    - b. On the Judges' Part
      - 1) If a judge is unable to fulfill a contract due to personal reasons, she is obligated to contact the assignor to determine which officials may still be available and call a proper replacement. If she fails to contact the assignor or does not give a minimum of 14 days' notice to the assignor and/or the Meet Director, a penalty of 2 hours honorarium and any non-refundable expenses incurred by the Meet Director will be paid to the Meet Director by the judge.
      - 2) Regardless of the timing of the cancellation on the part of the judge, if the Meet Director has purchased a non-refundable airline ticket, the judge is obligated to contact the airlines **PRIOR TO THE SCHEDULED DEPARTURE** to cancel the originating flight and to then reimburse the Meet Director for the cost of the ticket. The judge is then able to use the credit (minus a "change fee") to purchase another airline ticket for themselves within one year from the **DATE OF ISSUE** of the original ticket by providing the ticket number. If the ticket is not cancelled prior to the scheduled departure, it becomes null and void.

## II. Judging Compensation

- A. Hourly Meet Fees
1. Judges will be paid an hourly fee, according to their rating, with a minimum payment of **three** hours **PER DAY**.

## Chapter 5

2. For meets with 3 or more sessions PER DAY, judges are to be provided a minimum of two 30-minute break times. Meals are to be provided during breaks, when appropriate as determined by the Meet Referee, regardless of the number of sessions per day.
3. Additional breaks, of any duration, may be provided between sessions throughout the day.
4. The maximum amount of unpaid break time is 60 minutes (30 minutes for 2-session meets), including the required 30-minute breaks for lunch and/or dinner.
5. The daily number of paid hours is calculated by subtracting the required break time per day (minimum 30 minutes for two-session meets and maximum of 60 minutes for meets with more than two sessions) from the total time at the meet (from start of report time/judges' meeting to the completion of all four events for the day).

### EXAMPLES:

#### a. Three session meet:

EXAMPLE 1: Report time for judges' meeting is at 8:00 AM, march-in /competition begins at 8:30 AM and the last session ends at 8:00 PM. Two 30-minute breaks for meals were provided. Total time from report time to end of competition in the last session that day is 12 hours. Deduct the required break time (two 30-minute breaks = 60 minutes total break time); the judge will be paid for 11 hours.

EXAMPLE 2: If both break times between sessions were one hour instead of 30 minutes (120 minutes of break time), there would be a total time of 13 hours (report time at 8:00 AM; meet ends at 9:00 PM), deduct 60 minutes of required break time and judges would be paid for 12 hours.

#### b. Four session meet:

Report time 8:00 AM; break between sessions 1 and 2 is 20 minutes; break between sessions 2 and 3 is 40 minutes (lunch provided); break between sessions 3 and 4 is 40 minutes (dinner provided). Meet is completely over at 9:20 PM. Total time at meet is 13 hours 20 minutes, so round up to 13.5 hours. Total break time is 100 minutes. Subtract 60 minutes for the maximum break time allowed for a total of 12.5 paid hours.

6. If the required 30-minute break times for lunch/dinner have not been provided, payment for the day is calculated from the contracted report time to the end of the entire competition for that day. The Meet Referee must communicate with the Meet Director if, per the published competition schedule, the required 30-minute break time may not be provided.
7. At State, Regional and Nationals competitions which require a video analysis (Base Score) in addition to the judges' meeting, the paid judging time starts with the scheduled report time, up to one hour prior to the scheduled march-in time.
8. A portion of the hourly rate may be broken into halves, not less. Calculate the total time at the meet, then round off to the nearest half-hour (i.e., a total of 8 hours 15 minutes will be considered as 8 hours; a total of 8 hours 16 minutes will be considered as 8½ hours). Do not round up for each session. Subtract the required break time from the total (or adjusted) time at the meet to determine the number of hours for which to be paid the hourly rate based on rating.
9. The fee scale indicated in this document will be applicable for all USA Gymnastics Sanctioned Events unless otherwise specified in advance by the USA Gymnastics President.
10. This Judges' Compensation Package is in effect for all USA Gymnastics competitions, as specified, with exception of judging fees for Xcel meets with entry fees of \$35.00 or less.

### B. Championship Meet Fees

Judges shall receive a daily or flat rate, according to ratings. The Daily Rate applies to all meets of more than four hours - up to eight hours of actual judging time. Half-day competitions (up to 4 hours of actual judging time) will use the Half-Day Rate. For JO/Xcel Regional Meets only, any additional time over eight hours/day will be compensated at the regular hourly rate.

#### 1. Judges' fees to be calculated by:

- a. Calculate first the total time at the meet (report time to end of competition)
- b. Deduct up to 1 hour for break time (if only one break-deduct 30 minutes).
- c. Deduct 8 hours, which are paid by the daily rate
- d. Any excess hours are paid using the regular hourly rate.
  - i. Example: report time-8:00 AM, three sessions (2 breaks), meet ends 10 PM
  - ii. 14 hours – 1 hour break = 13 hours
  - iii. 8 hours to be paid at daily rate, 5 additional hours to be paid at regular hourly rate for specific rating

STATE CHAMPIONSHIPS FEES – Judges' fees for State meets may be negotiated by the State Administrative Committee and the chief official of the contracting organization but cannot exceed the basic fee schedule.

### C. Chief Judge/Meet Referee Payment (Applies to Junior Olympic meets only)

1. A Meet Referee/Chief Judge shall receive an additional \$10.00 per day at the following USA Gymnastics competitions:
  - a. State meets with four-judge panels
  - b. USA Gymnastics Regional Championships, regardless of the number of judges per panel.
  - c. Level 9 East/West Championships and Level 10 National Championships.
2. No dual compensation is given if the Meet Referee also serves as a Chief Judge.

## Chapter 5

3. The Meet Referee shall be paid the hourly fee for the time during which she/he is conducting official on-site Meet Referee responsibilities.
4. Chief Judge/Meet Referee fees are NOT paid at state meets with two-judge panels, or at any local/sectional meets.

### III. Xcel Judging Guidelines

- A. Judging Criteria: may be determined by the State Administrative Committee (example, ratings, number of judges per panel etc.).
  1. A Level 7/8 rating is required for Platinum and Diamond divisions.
    - A minimum of Level 9 rating is recommended for Diamond division.
  2. If there is a lack of qualified judges, the assignor must contact the RTCC for permission to assign a lower rated judge, if necessary.
- B. Recommendation: two judge panels.
- C. An Affiliated Judge: can be used.
- D. Affiliation: there may not be more than one judge per panel with the same affiliation.

Division	Judges' Rating	Rate per hour
Bronze and Silver	Non-Rated Pro Members	\$16.00
All Divisions	Level 4/5 only	\$18.00
	Level 6/7/8 only	\$20.00
	Level 4/5 and 6/7/8	\$22.00
	Level 9	\$26.00
	Level 10	\$30.00
	National	\$33.00
	Brevet	\$36.00



**USA GYMNASTICS JUDGES' COMPENSATION PACKAGE FOR WOMEN'S ARTISTIC GYMNASTICS  
(EFFECTIVE AUGUST 1, 2019 - JULY 31, 2020)**

Rate	\$36.00	\$33.00	\$30.00	\$26.00	\$22.00	\$20.00	\$18.00
Hours	Brevet	National	10	9	4/5 + 6/7/8	6/7/8 only	4/5
3	\$108.00	\$99.00	\$90.00	\$78.00	\$66.00	\$60.00	\$54.00
3.5	\$126.00	\$115.50	\$105.00	\$91.00	\$77.00	\$70.00	\$63.00
4	\$144.00	\$132.00	\$120.00	\$104.00	\$88.00	\$80.00	\$72.00
4.5	\$162.00	\$148.50	\$135.00	\$117.00	\$99.00	\$90.00	\$81.00
5	\$180.00	\$165.00	\$150.00	\$130.00	\$110.00	\$100.00	\$90.00
5.5	\$198.00	\$181.50	\$165.00	\$143.00	\$121.00	\$110.00	\$99.00
6	\$216.00	\$198.00	\$180.00	\$156.00	\$132.00	\$120.00	\$108.00
6.5	\$234.00	\$214.50	\$195.00	\$169.00	\$143.00	\$130.00	\$117.00
7	\$252.00	\$231.00	\$210.00	\$182.00	\$154.00	\$140.00	\$126.00
7.5	\$270.00	\$247.50	\$225.00	\$195.00	\$165.00	\$150.00	\$135.00
8	\$288.00	\$264.00	\$240.00	\$208.00	\$176.00	\$160.00	\$144.00
8.5	\$306.00	\$280.50	\$255.00	\$221.00	\$187.00	\$170.00	\$153.00
9	\$324.00	\$297.00	\$270.00	\$234.00	\$198.00	\$180.00	\$162.00
9.5	\$342.00	\$313.50	\$285.00	\$247.00	\$209.00	\$190.00	\$171.00

**Required Break  
Time: 30 minutes  
between scheduled  
sessions.  
(Max = 60 minutes)**

Per Diem	Local	Overnight
\$15.00	3 - 7½ hours or under 3 hours but 100 mi. or more RT	\$15/meal or Max. of \$40.00/day
\$30.00	8+ hours	
Mileage: current IRS rate RT		

**Meet Referee/Chief Judge fee (JO only) - State Meet w/ 4-judge panels, Regional, East/West, and National Championships: \$10/day**

All fees are based on a minimum of 3 hours.

Junior Olympic / Xcel Regional Championships		
Rating	Daily (8 hours)	Half Day (4 hours)
Brevet	\$220.00	\$110.00
National	\$210.00	\$105.00
Level 10	\$200.00	\$100.00
Level 9	\$190.00	\$95.00
Level 8	\$180.00	\$90.00

Level 9 East/West Championships	\$275.00/day
Level 10 JO Nationals Championships	\$350.00/day
Elite National Qualifiers	\$250.00 Full Day \$125.00 Half Day
Elite Classic	\$350/day
USA Championships	\$350/day
US Olympic Trials	\$350/day
National Collegiate Meet	\$250.00 Full Day \$125.00 Half Day

*For JO Regional Championships only, the additional time over 8 hours will be compensated at the regular hourly rate.*

*At the National Qualifiers, Championships rate will apply to all Elite sessions (compulsory and optional). If a judge is assigned to the National Elite Qualifier and also judges additional JO Invitational sessions on the same day as the Elite session(s), the judge will be paid the hourly rate for the JO sessions and Championship rate for the Elite sessions.*

## Chapter 6 - Xcel Competitive Program

### I. Overview

The USA Gymnastics Xcel program was developed as an alternative competitive program offering individual flexibility to coaches and gymnasts. The goal of Xcel is to provide gymnasts of varying abilities and commitment levels the opportunity for a rewarding gymnastics experience.

#### **ATHLETES: MUST HAVE A USA GYMNASTICS INTRODUCTORY OR ATHLETE MEMBERSHIP TO COMPETE AT A SANCTIONED EVENT.**

- A. If a gymnast has never competed in the USA Gymnastics Junior Olympic Program (Levels 1-10) and wishes to compete in the Xcel Program, she may choose to register as an Introductory Member in the Bronze or Silver Division or an Athlete Member in the Gold, Platinum, or Diamond Division.
  - If she registers as an Introductory Member and at a later time in the same competitive year she wishes to move to JO Levels 3 or 4, she must upgrade her membership by submitting a regular Athlete Membership application and paying the difference in price.
- B. If a gymnast already has an Athlete Membership she is not required to change or purchase a new membership for Xcel. However, she must change to her appropriate Xcel division. This can be done online through USA Gymnastics.
- C. Athletes competing in both Xcel and the JO Program in the same competition year should register as an Athlete member.
- D. Athletes must have the appropriate Xcel division OR JO level box checked before participating in a sanctioned USA Gymnastics competition.

A gymnast may compete in a maximum of two (2) State meets per competitive year (one per season), either at the same or higher division.

A gymnast is not required to compete in the All-Around. If she chooses not to compete in the AA, she must touch the event(s) she is NOT competing. Her scores may count towards team scores.

The Xcel program includes five competitive divisions – Bronze, Silver, Gold, Platinum, and Diamond.

Xcel competitions are conducted throughout the United States and are organized by the USA Gymnastics State and Regional Administrative Committees. Each state has the jurisdiction to determine its state calendar, according to the needs of its members. An Xcel COMPETITIVE YEAR is defined as the period from August 1 through July 31. A COMPETITIVE SEASON is defined as that period from the first designated qualifying competition through the culminating Championships at each division.

### II. Age Requirements, Entry Divisions, and Mobility Scores

- A. In the spirit of good sportsmanship, fairness to all athletes and competitive balance, the mobility system within the Xcel Program should be followed in the manner that it was intended:
  1. Before moving up a competitive division, every athlete should show proficiency at her current competitive division.
  2. Once a high level of proficiency is achieved at the athlete's current competitive division, she should strive to move up to the next competitive division, as long as it is done safely.
  3. For athletes to repeat a competitive division with the intent to gain an advantage over other competitors or teams IS NOT in the spirit of the Xcel Program or youth sports in general.
  4. No mandate scores are permitted at any competitive division.
  5. The Xcel program's purpose is to provide competitive opportunities for all athletes, regardless of their age, ability level, or training commitment in terms of hours and/or finances.
- B. Age Determination and Regulations
  1. All gymnasts must reach the minimum age for the division before competing in any USA Gymnastics sanctioned competition (see chart on the next page).

Example: Bronze State meet date is Dec. 1; the last Bronze State Qualifier is November 17; the gymnast will turn the minimum age for Bronze (5 yrs. old) on November 28<sup>th</sup>. She is ineligible to compete in the qualifying meet, and therefore does not have the opportunity to qualify to the Bronze State Championships that season.
  2. For invitationals and qualifying meets below the State Championships, the Meet Director may determine the age divisions and must publish such information in the pre-meet information.

## Chapter 6

3. For all meets under the jurisdiction of the State or Regional Administrative Committees, the respective committee may determine the method of determining age divisions. There are two options:
  - a. Age groups for the season: established by specific ages (i.e., 8-10 yr. olds, 11-12, etc.).
    - 1) In this case, the age divisions should be determined and published PRIOR to the competitive SEASON and the only adjustments that may be made during the season are sub-divisions of the age groups.
    - 2) The gymnast's age for the competitive season is determined by the date of the final day of competition at the culminating championship meet for that level. Exception: The gymnast must have reached the minimum age for her level prior to entering any qualifying competition.
    - 3) The gymnast must compete with the age division as designated for the entire season.
    - 4) Published results MAY NOT include the gymnast's date of birth.
  - b. Age groups for each competition: established by dividing the athletes by actual birth date into approximately equal groups according to a pre-determined number of age divisions or by a pre-determined maximum number of athletes per age division.
    - 1) Meet Directors must publish or post online the meet schedule with age divisions as soon as possible after the entry deadline.
    - 2) Published results MAY NOT include the gymnast's date of birth.
4. If a gymnast competes in the wrong age division, her scores are invalid for the meet (may not be used for All-Around, Individual Events or Team awards); however, the score achieved may be used for division mobility.
  - If, due to valid unforeseen circumstances, a gymnast is unable to compete with her designated age group, she may compete on another day (or in another session) with the approval of the SACC. She will not be eligible for ANY awards. Her score may be used for mobility or qualification purposes (if qualification is by score, not placement or percentage in a given age group) to the next meet.

### XCEL AGE/ENTRY REQUIREMENTS AND MOBILITY SCORES OVERVIEW CHART

Division	Minimum Age Requirement	Pre-requisite Scores	Entry Division from the JO Program
<b>Bronze</b>	Reached 5 <sup>th</sup> birthday	None	JO Levels 1,2
<b>Silver</b>	Reached 6 <sup>th</sup> birthday	None	JO Levels 1,2,3
<b>Gold</b>	Reached 7 <sup>th</sup> birthday	31.00 AA at Silver Division or 8.0 IES	JO Levels 3,4
<b>Platinum</b>	Reached 8 <sup>th</sup> birthday	31.00 AA at Gold Division or 8.0 IES	JO Levels 5,6, 7
<b>Diamond</b>	Reached 9 <sup>th</sup> birthday	31.00 AA at Platinum Division or 8.0 IES	JO Levels 7,8,9, 10

\* See for specifics of dropping back in the next section

#### C. Entry into Xcel Divisions

1. Gymnasts that have no previous competitive experience may enter at Bronze or Silver, at their coach's discretion. The Gold Division is NOT an entry division. The Mobility Score from Silver to Gold is 31.00 AA or 8.0 IES.
2. Gymnasts currently competing in the Xcel program must follow the chart above for mobility.
3. Any athlete who has previously competed in the Xcel Program, but has been inactive for one or more years, must contact their State Administrative Committee Chairman for proper entry regulations. The options are:
  - a. Remain at the Division at which they last competed.
  - b. Move up one Division if they achieved the mobility score during their last season.
  - c. Move down one Division without petitioning.
4. Any gymnast who has had previous competitive experience in programs outside of USA Gymnastics must petition to enter at Gold and above by submitting a formal written request to the State Administrative Committee.
5. Any gymnast who has had previous competitive experience in USA Gymnastics and who is a minimum of 14 years of age OR is at least a freshman in High School is eligible to petition by submitting a formal written request to the State Administrative Committee for entry into Platinum or Diamond. The petition must be accompanied by a video that demonstrates her skill level.
  - Athletes (US citizens or Non-US Citizens) who have resided outside the US, have competitive experience outside the US, and now reside in the US, are eligible to petition by submitting a formal written request to the Regional Xcel Chairman for entry into the Xcel Program at Platinum or Diamond. The petition must be accompanied by a video that demonstrates the skill level for which she is submitting the petition and proof of residency outside the US. For additional information on foreign athlete participation, please refer to Chapter 2, page 26.
6. Since the Xcel program is an alternative/separate program, IT CANNOT BE USED TO SATISFY MOBILITY REQUIREMENTS IN THE JO PROGRAM.

## Chapter 6

### D. Dropping Back through the Divisions

1. The State Administrative Committee must determine, prior to the beginning of the competitive year, a designated "declaration" date for each division. The highest division in which the athlete competes in a sanctioned competition after the "declaration" date designates her division for the remainder of the current season.
  2. If the athlete competed at an Xcel State Championships (or higher) and wishes to drop back through the divisions, her coach must submit a "reason for change" letter.
    - a. For Bronze, Silver, and Gold Divisions, the "reason for change" letter is sent to the State Administrative Committee **Chairman to be considered by the State Administrative Committee.**
    - b. For Platinum and Diamond Divisions, the "reason for change" letter is sent to the Regional Technical Committee **Chairman to be considered by the Regional Administrative Committee.**
- E. A Level 10 JO gymnast may petition for entry into the Xcel program by sending a "reason for change" letter FROM HER COACH to the National Xcel Committee Chairman.
1. All petitions must be received at least two weeks prior to the Xcel State Championships.
  2. The National Xcel Committee will review the petition and the Chairman will notify the coach of the acceptance/denial of the petition and will copy the respective State and Regional Administrative Committee Chairmen and the Regional Technical Committee Chairman.
  3. Accepted petitioned athletes may not re-enter the JO Program as a Level 10 during the JO competitive year (through JO National Championships of the year in which she competes in the Xcel program).
  4. Clarification: An athlete is considered an Xcel athlete when she enters her first USA Gymnastics sanctioned event in an Xcel division.
  5. If a JO Level 8 or below athlete wishes to enter the Xcel Program in a Division below the allowable Division, her coach may submit a "reason for change" letter to the State Administrative Committee Chairman for approval. If a JO Level 9 or 10 athlete wishes to enter the Xcel Program in a Division below the allowable Division, her coach may submit a "reason for change" letter to the Regional Technical Committee Chairman for approval.
    - Valid reasons would include injury, illness, or other extenuating circumstances that would have prevented the athlete from continuing to train at the level at which they previously competed.

### III. Other Competition Experiences

#### Competition Experience Policies

- A. Individual Event Specialists: the mobility score for advancement to the next division for Individual Event Specialists at Gold is 8.0 per event to move to Platinum, and at Platinum is 8.0 per event to move to Diamond.
- B. Athletes who are limited in the number of events in which they can perform due to a permanent physical handicap (verified by a physician) may petition to qualify to higher division by achieving an average score equal to the average of the All-Around qualifying score for that division.
- C. Status for competing as an IES to qualify to the next higher meet must be declared at the time of entry to the qualifying meet, not during or after the conclusion of the competition.

### IV. General Procedures for Petitions for USA Gymnastics Xcel Competitions

- A. Petitions may be considered for the following reasons:
  - Injury, illness or family tragedy (e.g., death, natural disaster)
- B. If an athlete is injured prior to a qualifying meet, but is capable of competing in one, two or three events, she may compete in the qualifying meet without jeopardizing her right to petition to the next competition.
- C. The coach (or club administrator) is responsible for submitting all necessary documentation for the petition on behalf of the petitioning athlete.
- D. Entry fees for petitioned athletes should be submitted by the entry deadline. If the petition is denied, the Meet Director must refund the entry fee within three weeks.
- E. Injury Petition Forms are posted on the USA Gymnastics website under Women's Program – Forms – Petition Forms - <https://usagym.org/PDFs/Forms/Women/injury2015.pdf>.
- F. Specific procedures for State and Regional competitions are in the sections for those events.

# Competition

## I. Types of Competition

A. Overview of types of competition available to the divisions and the qualifying scores to enter:

Division	Local	State Championships	Regional Championships
Bronze	X	To be determined by the State Administrative Committee	To be determined by the Regional Administrative Committee
Silver	X	To be determined by the State Administrative Committee	To be determined by the Regional Administrative Committee
Gold	X	To be determined by the State Administrative Committee	To be determined by the Regional Administrative Committee
Platinum	X	To be determined by the State Administrative Committee	To be determined by the Regional Administrative Committee
Diamond	X	To be determined by the State Administrative Committee	To be determined by the Regional Administrative Committee

## II. General Regulations

A. The State Administrative Committee determines:

1. If State Championships for all Xcel divisions will be conducted.
2. If sub-divisions within Divisions will be offered, such as first year competitors and veterans, or if a team competition will be conducted separately from the State individual competition.
3. The qualifying requirements for State Championships.
4. The competitive schedule for State Championships.
  - a. It is recommended that a reasonable period of preparation be provided between seasons.
  - b. May conduct one annual State Championships, or one Fall and one Spring State Championships.
5. Number of Judges used for USA Gymnastics Sanctioned Competitions.
6. Qualified Judges: all Xcel Divisions may be judged by Rated judges, Professional, or Junior Professional Coach Members; however, the State Administrative Committee determines, if any additional criteria will be used for state qualifying competitions and State Championships.
  - a. A Level 7/8 rating is required for Platinum division.
    - A minimum of Level 9 rating is recommended for Diamond division.
  - b. If there is a lack of qualified judges, the assignor must contact the RTCC for permission to assign a lower rated judge, if necessary.
7. Entry Fees for State Meets:
  - a. Maximum being \$75.00 (Bronze, Silver, Gold)
  - b. Maximum being \$85.00 (Platinum and Diamond).
  - c. Unless approved change by the Regional Administrative Committee Chairman
8. Individual Awards for State Meets: with a minimum of 40% for individual awards.
9. Team Awards for each Division: (Bronze, Silver, Gold, Platinum, Diamond). Divisions should NOT be combined for Team Awards.
  - a. If a state does not have enough gymnasts in one or more Divisions to have a team competition, Divisions may then be combined for team awards. In order to do this, the State Administrative Committee Chair must request permission from the Regional Administrative Committee Chair.

B. The Regional Administrative Committee determines:

1. If Regional Championships will be conducted and which divisions will participate.
2. The qualifying procedures/requirements, format and schedule of the Regional Championships.
3. Individual and team awards for the Regional Championships.
4. Number, rating, and selection procedure for judges for the Regional Championships.

C. Local Meets

1. Local Meets are not under the organizational responsibilities of the State Administrative Committee; i.e., Meet Directors may set dates, entry fee and gate fee, may contract their officials (using the USA Gymnastics Contract) or by requesting the services of the State's judging contractor, and may conduct Team competition.
  - Includes dual/triangular meets between clubs, inter-squads, and invitationals.

## Chapter 6

2. May be used for:
    - a. mobility only, or
    - b. qualification to the State Championships, at the discretion of the State Administrative Committee.
  3. May have only one club (team) competing to obtain a Sanction.
  4. Any Professional or Junior Professional member or Introductory Coach is allowed to judge Xcel; however, the State Administrative Committee determines if any additional criteria will be used for state qualifying competitions and State Championships.
    - For any competition using only a 1-judge panel, it is recommended to have a floating Meet Referee, if possible.
  5. Results from local meets need to be mailed or e-mailed to the State Administrative Committee Chairman or designated state administrative committee representative and the meet director of the State Championships.
- D. State Championships
1. Are under the **total** jurisdiction of the State Administrative Committee and State Administrative Committee Chairman.
    - The format and number of athletes must be approved by the RXCC and RTCC.
    - The Meet Director must utilize the USA Gymnastics Meet Reservation System for registration (not to accept payments) and utilize the pre-printed Coaches' sign-in sheets during the competition.
  2. May be conducted for all divisions, at the discretion of the SAC.
  3. May be conducted in the fall and/or spring for all divisions, at the discretion of the State Administrative Committee.
    - For those divisions that have a Regional competition, the respective State Meet must be scheduled a minimum of three weeks prior to the Regional meet. Any deviation to that guideline must be approved by the Regional Administrative Committee Chairman.
  4. The State Administrative Committee determines the number of judges per panel, selects the judges and Meet Referee, and may determine the event assignments. It is recommended that the State Administrative Chairman ask the Meet Referee to make the event assignments.
  5. A present Xcel gymnast who competed in the same division the previous year and competed in the previous year's Regional Championships (and fulfilled the qualification requirements or achieved a score equal to or greater than the current year's respective State Meet qualifying score) may directly enter the current year's State Meet in her respective division.
  6. Entry forms and fees for Xcel Regional meets must be filed and paid (with a club/company check), unless an electronic entry system is in place, to the USA Gymnastics designated official at the qualifying meet, who will forward them to the Meet Director of the next meet. Entries for Regional meets must be submitted to the designated USA Gymnastics personnel at the respective State Championships. Each club must be prepared to pay for all their qualifiers with one company check per level.
  7. PETITIONS TO STATE CHAMPIONSHIPS (ALSO SEE GENERAL RULES FOR PETITIONS - CHAPTER 6 PAGE 49)
    - a. NO petitions are allowed if the qualification to the State Meet is by a percent of a percent or a designated number of each age division and not by score.
    - b. If a gymnast is unable to compete at the Sectional or any local State-qualifying Meet (or cannot compete in the All-Around at State Meet due to injury or illness prior to or during the State Meet), her coach may petition the State Administrative Committee Chairman to allow the athlete to directly enter the State Championships, if the following requirements are met and documentation is included with the petition form:
      - 1) If there is a qualifying score: A photocopy of the results of one sanctioned meet from the current season showing a score, which is equal to or greater than the state qualifying score.
        - If the gymnast competed in the same division in the previous season and qualified to the State meet or above, she may petition with the previous year scores from State or above meets.
      - 2) Written request from the coach.
      - 3) A Licensed Medical Professional's written verification of the illness or injury and date of release for return to gymnastics activity.
    - c. If an athlete who is unable to compete at any Sectional or local State-qualifying meets in the current season (or cannot compete AA at such events) due to injury or illness and is also lacking scores from last year's season due to injuries but has previously qualified to and competed in the State or above division competitions at the same level, an injury petition may be considered under special circumstances by the State Administrative Committee Chairman. If necessary, the Regional Technical Committee Chairman and the Regional Xcel Committee Chairman will be consulted. The petition must include:
      - 1) A copy of meet results from the previous State or Regional competition with scores, which are at least one point higher than the current State qualifying score.
      - 2) A current video.
      - 3) Written request from the coach or parent.
      - 4) A Licensed Medical Professional's written verification of the illness or injury and date of release for return to gymnastics activity.

## Chapter 6

- d. Petition Deadlines: petitions to the State Meet must be received no later than the Wednesday after the last qualifying meet is held. Petitions must be sent to the State Administrative Committee Chairman by e-mail, Express Mail or FAX.
    - 1) The petitioner will be notified of the approval or denial of the petition by the State Administrative Committee Chairman no later than one week before the competition.
    - 2) The State Administrative Committee Chairman will notify the Meet Director of the approval or denial of the petition no later than one week before the competition.
    - 3) If a petition is accepted but the gymnast is unable to compete, the coach **MUST** notify the Meet Director and the State Administrative Committee Chairman.
  8. USA Gymnastics Xcel Awards for State Championships must be ordered from the national medal company by the State Administrative Committee Chairman, or designee. Awards should be ordered a minimum four (4) weeks before the competition.
  9. Results from State Championships need to be mailed or e-mailed to the Regional Administrative and Regional Technical Committee Chairmen, Regional Meet Director, and the State Chairman of the respective state within 72 hours.
  10. The State Meet Director must send a Financial Report to the State Administrative Committee Chairman within **60** days of the completion of the meet.
- E. Regional Championships
1. Are under the **total** jurisdiction of the Regional Administrative Committee.
    - a. The format and number of athletes must be approved by the Regional Xcel Committee Chairman and Regional Technical Committee Chairman.
    - b. Entry fees for Xcel Regional Championships are determined by the Regional Administrative Committee and must be approved by the National Administrative Committee Chairman.
    - c. The Meet Director must utilize the USA Gymnastics Meet Reservation System for registration (not to accept payments) and utilize the pre-printed Coaches' sign-in sheets during the competition.
  2. May be conducted for all Xcel divisions.
  3. State team competition may be conducted as a separate competition (with a designated number of athletes qualifying by rank order) or as part of the individual competition in which each state designates which individual's scores will count toward the State team score.
  4. If a state has no qualifiers in a particular division to Regionals, the gymnast with the highest AA from the State Championships (from any of the age divisions) will be invited to compete at the Regional meet, regardless of the score.
  5. The Regional Administrative Committee may guarantee up to 120 gymnasts to Regional Championships if there is an insufficient number of athletes who achieved the qualifying score.
  6. The Regional Administrative Committee selects the judges and determines the number of judges per panel.
  7. If the number of athletes in one age division requires that two sessions of competition be conducted, the Meet Director shall conduct a random draw by team to fill the sessions.
  8. Regional Meet Directors must send regional meet information to the State Meet Director, with copies to the Regional Xcel Committee Chairman, Regional Technical Committee Chairman and Regional Administrative Committee Chairman at least one week prior to the State Championship.
  9. Entry forms and fees for Regional Championships will be collected by the USA Gymnastics designated official at the State Championships and sent to the Regional Meet Director, unless an electronic entry system is in place.
  10. Petitions to Regional Championships (Also See General Rules for Petitions Chapter 6, page 49)
    - a. There are NO petitions to Regional Championships if qualification is by a percentage or by *specific number*.
    - b. If a gymnast is unable to compete at the State Meet (or cannot compete in the All-Around at State Meet) due to injury or illness prior to or during the State Meet, her coach may petition the Regional Technical Committee Chairman (or Regional Technical Assistant, if so designated) to allow the athlete to directly enter the Regional Championships, if the following requirements are met and documentation is included with the petition form:
      - 1) A photocopy of at least one pre-state, sanctioned meet results from the current season (at the division to which they are petitioning) showing a score at least one point (1.00) greater than the regional qualifying score OR
        - a) If the gymnast competed in the same division in the previous year's Xcel Regional Championships and her AA score was at least one point (1.00) greater than the current Regional qualifying score, she may submit her last year's Regional score as her pre-State meet score.
      - 2) A Licensed Medical Professional's written verification of the illness or injury and date of release for return to gymnastics activity.
      - 3) Written request from the coach.
    - c. If an athlete who is unable to compete at the State Championships (or cannot compete AA at State Meet) due to injury or illness is also lacking scores from both the current and last year's season due to injuries but has previously qualified to and competed in Xcel Regionals at the same division, an injury petition for the same division may be considered under special circumstances by the Regional Technical Committee Chairman and the Regional Xcel Committee Chairman. If necessary, the State Administrative Committee Chairman and the National Chairmen (Xcel and Technical Committee) will be consulted. The petition must include:

## Chapter 6

- 1) A copy of the meet results must be included with the petition form. The scores from the previous Regional competition must be at least one point higher than the current Regional qualifying score for the division.
  - 2) A current video that is sent to both Regional officers.
  - 3) A Licensed Medical Professional's written verification of the illness or injury and date of release for return to gymnastics activity.
  - d. The Regional Technical Committee Chairman (or her appointee) will handle the petition, in consultation with the Regional Xcel Committee Chairman and the State Administrative Committee Chairman. If an agreement cannot be reached, the Regional Technical Committee Chairman will make the decision.
  - e. Deadlines for Petitions to Regional Championships:
    - 1) Coaches must notify their Regional Administrative Committee Chairman AND their Regional Technical Committee Chairman by FAX or e-mail NO LATER THAN the Monday following the State Championships of any athletes they intend to petition to their Regional meet.
    - 2) The complete Injury/Illness petition form (found online at <https://usagym.org/PDFs/Forms/Women/injury2015.pdf>). The request in writing from the coach and official results are due the Monday following the State Championships by 5:00pm local time. All other required documents (physician's note) are due the Wednesday following the State Championships by 5:00pm local time. Also send a copy to the State Administrative Committee Chairman.
    - 3) The Entry form and fees must be sent directly to the Meet Director, specifically marked as "Petition pending". If the petition is denied, the Regional Technical Committee Chairman will contact the Meet Director, who will refund the entry fee.
    - 4) If the gymnast was injured at the State Championships, the entry fees and form should be given to the USA Gymnastics officer who is designated to collect Regional entries at the State meet, unless an electronic entry system is in place. (Fees will be returned within three weeks if the petition is not accepted.)
    - 5) The petitioner will be notified of the approval or denial of the petition by the Regional Technical Committee Chairman a minimum of one week prior to the Regional meet.
    - 6) The Regional Technical Committee Chairman will notify the Meet Director of the approval or denial of the petition.
    - 7) If a petition is accepted, but the gymnast is unable to compete, the coach must IMMEDIATELY notify both the Meet Director and the respective Regional Technical Committee Chairman.
11. Awards:  
USA Gymnastics Xcel Awards for Regional Championships must be ordered from the national medal company by the Regional Administrative Committee Chairman (or designee). Awards should be ordered a minimum four (4) weeks before the competition.
12. Results of Regional Meets must be e-mailed within 72 hours to:  
a. State Administrative Chairmen in that region, the Regional Xcel, Regional Technical, and Regional Administrative Chairman.
13. The Meet Director must send the Financial Report form within 45 days (or otherwise designated time) to the Regional Administrative Committee Chairman

## Apparatus Requirements for Xcel Competitions

### I. General Considerations

- A. Athlete safety guidelines, as listed in the *USA Gymnastics Safety Handbook*, should always be considered.
- B. It is recommended that there be a clearance of 5' to 6' from one apparatus to any other. This includes corresponding mat area or any other obstruction, i.e., other apparatus, walls, pillars, etc.
- C. It is recommended that there be a minimum of a 20-foot ceiling height for all USA Gymnastics sanctioned competitions.
- D. Equipment specifications, including vault runway thickness, must be published in the pre-meet information.
  - Exact bar measurements must be listed on bid forms for sectional and above meets.
- E. Bronze, Silver, and Gold gymnasts may set the equipment to facilitate the exercise within the standards listed on each event below.
- F. All equipment and matting used at a USA Gymnastics sanctioned competition must be manufactured by a recognized equipment manufacturer.
- G. Matting Height Specifications:
  1. COMPETITION LANDING MATS FOR VAULT, BARS AND BEAM
    - a. One 10-12 cm (4") competition landing mat is required; a second 10-12 cm (4") may be placed on top of the required mat for compulsory and optional competition. If a second 10-12 cm (4") mat is used for Platinum or Diamond, it must be a minimum of 7' by 10'.
    - b. Maximum height is 24 cm (9").



## Chapter 6

- c. 20 cm (8") competition landing mats are also allowed (but are not required).
  - 1) For vault, if 20 cm (8") mats are used, it is recommended that the Meet Director make every effort to also provide one 10-12 cm (4") competition landing mat.
  - 2) For Bars and Beam, in order to use a 20 cm (8") mat, the apparatus must be capable of being raised to the FIG maximum height allowance (High Bar – 246 cm; Beam – 125 cm).
- d. A 3 cm (1¼") base mat must be used if a 10 cm (4") competition landing mat is used. When using 12 (4") – 20 cm (8") mats, a base mat is not required.
  - The 3 cm (1¼") base mat may be placed underneath or on top of the competition landing mat.
- e. The area under the apparatus and/or in the landing area must be matted with competition landing mats that are uniform in height.

### H. Springboard/Mounting Specifications

1. Only unaltered manufactured vaulting boards are approved for USA Gymnastics competitions. The height of the board (22cm ± 1.5cm) is measured from the floor to the highest point of the board, including the covering. All springboards meeting the stated specifications are allowed; however, it is required to provide a springboard with coil springs.
 

Exceptions:

  - a. Bronze and Silver may use a manufactured "Junior" vaulting board.
  - b. Xcel Bronze, Silver, and Gold athletes may use alternative springboard apparatus, provided they are manufactured by a gymnastics equipment manufacturer. The apparatus should resemble the shape of a vault board, with a maximum of 38 cm (15 inches) at the high end and a maximum of 10 cm (4 inches) at the low end. The surface producing the "spring" may be other than the traditional coil springs, such as an air bladder or small trampoline bed.
  - c. If an alternative springboard is used at Platinum and Diamond division in a USA Gymnastics sanctioned event, the vault is considered VOID.
  - d. All divisions may also use a manufactured mat shaped like a springboard (Mount trainer/mount mat).
2. Plywood is not permitted underneath the board.
3. All Meet Directors must arrange to have boards that accommodate gymnasts of varying weights. Any boards brought in to a competition must be assigned to an event and must be available to all gymnasts in that session for warm-up and competition. The following 3-4 spring configurations for the springboard have been approved and may be utilized in USA Gymnastics sanctioned competitions:

4 COIL SPRING PLACEMENT (OPTION 1)



4 COIL SPRING PLACEMENT (OPTION 2)



4 COIL SPRING PLACEMENT (OPTION 3)



3 COIL SPRING PLACEMENT



## Chapter 6

4. A board used to mount Bars or Beam may be placed on the competition landing mat(s) (one or two 10-12 cm (4") mats or one 20 cm (8")). The board may also be placed on the allowable competition landing mats plus the supplemental matting of 5-10 cm (sting mat or 4" throw mat type skill cushions).
  - a. For Bronze, Silver and Gold divisions: any combination of manufactured mats, skill cushions or padded spotting/skill blocks may be used for mounting purposes.
    - Any manufactured mounting apparatus may be placed on top of the mats.
  - b. For Platinum and Diamond: a manufactured mount mat (mount trainer) or folded panel mat may be used instead of a board for mounting purposes.
  - c. The board (or mount mat) must be removed as soon as possible after the gymnast has mounted.
  - d. For Platinum and Diamond divisions, the board (or mount mat) MAY NOT be placed on a 20 cm (8") skill cushion for the purpose of mounting.
5. For Xcel, the gymnast may stand (without a board) on one or two 10 -12 cm (4") landing mats or one 20 cm (8") mat (with or without a 3 cm (1¼") base mat placed under or on top of the competition landing mat.)
  - a. The gymnast may also stand on an "up to 20 cm (8-inch) skill cushion" (sting, throw mat or 20 cm (8") skill cushion) that is placed on the competition landing mat(s).
  - b. For Bronze, Silver and Gold, any combination of competition landing mats and skill cushions may be used to facilitate the mount.
    - When performing the uneven bar mount of glide swing, then back hip pullover (or jump front support mount), the athlete may stand on a panel mat, spotting block, or board placed on the above matting to initiate the jump into the glide swing. This mat/board must be removed as soon as possible after the jump into the glide swing.
- I. Make sure all reasonable safety measures are considered. Examples:
  1. Each competitive area must have its own physical space and may not overlap with another competitive area.
  2. There cannot be any obstructions on the Floor Exercise Area.
  3. There must be sufficient room for mounting, dismounting, and vaulting areas.
  4. Procedures for the removal of blood and disinfection of the apparatus: A solution of 1 part bleach and 10 parts water (or an Anti-viral spray disinfectant) should be available for the removal/disinfection of blood from the apparatus or matting.
- J. Conversion for inches to centimeters:

Approx.	¾ inch	=	2 cm
	4 inches	=	10 cm
	4½ inches	=	12 cm
	8 inches	=	20 cm
	9 inches	=	24 cm

## II. Vault

- A. Bronze Vault
  1. Mat stack for Bronze Vault 1 and Bronze Vault 2
    - a. Bronze apparatus:

Mat stack / Matting System – minimum of 40 cm (16 inches) in height ( $\pm 2.5$  cm (1 inch)). Any combination of manufactured competition landing mats, skill cushions and/or port-a-pit may be used; however, the top layer of matting MUST be a minimum of a 10 cm (4-inch) skill cushion or the port-a-pit, an inflatable mat may also be used in the configuration of matting; however, the uppermost landing surface must be a minimum of a 10 cm (4-inch) skill cushion. The max height of the mat stack is 120 cm (approximately 48",  $\pm 2.5$  cm (1 inch)).

      - 1) The mat stack may be placed on top of a solid foam pit.
      - 2) An additional mat (minimum of 10 cm (4")) must be placed on the floor behind the mat stack.
      - 3) All mats used in forming the mat stack must be a minimum of 5' wide and 10' long.
      - 4) An unfolded panel mat (or any manufactured matting to facilitate a firm surface) may be placed on top of the uppermost surface of the mat stack/resi pit if necessary to provide a more stable landing surface. This mat must cover the entire uppermost surface.
      - 5) The top surface may be either a "squared" (standard 8" mat corners) or "curved" (similar to a table trainer) on the front edge.

## Chapter 6

### B. Silver Vault

#### 1. Mat stack / Matting System for Silver Vault.

##### a. Silver apparatus:

Mat stack / Matting System – minimum of 60 cm (24 inches) in height ( $\pm 2.5$  cm (1 inch)). Any combination of competition landing mats, skill cushions and/or port-a-pit may be used; however, the top layer of matting MUST be a minimum of a 10 cm (4-inch) skill cushion or the port-a-pit, an inflatable mat may also be used in the configuration of matting; however, the uppermost landing surface must be a minimum of a 10 cm (4-inch) skill cushion. The max height of the mat stack is 120 cm (approximately 48",  $\pm 2.5$  cm (1 inch)).

- 1) The mat stack may be placed on top of a solid foam pit.
- 2) An additional mat, minimum 6' x 12' x 4" (10cm) must be placed on the floor behind the mat stack.
- 3) All mats used in forming the mat stack must be 5' wide and a minimum of 5' long,  $\pm 2$  inches.
- 4) An unfolded panel mat (or any manufactured matting to facilitate a firm surface) may be placed on top of the uppermost surface of the mat stack/resi pit if necessary to provide a more stable landing surface. This mat must cover the entire uppermost surface.
- 5) The top surface may be either a "squared" (standard 8" mat corners) or "curved" (similar to a table trainer) on the front edge.

### C. Gold, Platinum, and Diamond Vault

#### 1. The vaulting table is required for Silver, Gold, Platinum, and Diamond. The maximum vaulting table height is 135 cm ( $\pm 1$ cm). If using a vault table with two uprights, both must be set at the same height. The height is determined by measuring the distance from the floor to the center top of the vault table.

- a. The center top of the vault table is determined by measuring 68 cm from the back of the vault table. Tape of any kind, including athletic tape, may NOT be placed on top of the table at any time during warm-up or competition.
- b. If the vault runway is on a raised platform, the vault table must also be placed on a raised surface of the same height and the measurement of the vault table should be taken from the runway surface to the center top of the vault table, rather than from the floor.
- c. All manufactured models of the vault table (including "retro-fit" tables that are inserted into the uprights of the old horse) are allowed for competition, provided that they are capable of being adjusted to the various height specifications allowed for Xcel athletes. Matting must be used to cover the upright of the vault table as well as to cover any weights placed on the vault base for stability.
- d. Athletes in all divisions may use the vault table at any manufacturer setting.

### D. Runway

#### 1. Measurement is from the front of the vaulting apparatus. The runway should be a clearly defined area that provides a flat, consistent surface, free of cracks, obstructions or seams. The Meet Director must provide a tape measure, which must be extended the length of the runway in order for the gymnasts to find the point at which to start their run. Minimum width of the runway should be the width of the board.

#### 2. Runway specifications:

##### a. Lengths:

- 1) A 70' minimum, 80' maximum runway is allowed for Platinum and Diamond.
- 2) A 60' minimum, 80' maximum runway is allowed for Bronze, Silver, and Gold.

##### b. Thickness: A minimum thickness of 3.5 cm (1 and 3/8 inches) ( $\pm 3$ cm or 1/8 in.) is required for the vault runway at Platinum and Diamond.

##### c. Athletic tape or Velcro strips (no chalk) may be placed on the vault runway, provided that such markings are removed no later than the end of the rotation. Maximum width of Velcro strip or athletic tape is 5 cm (2"), maximum length is 3 feet.

##### d. For the safety of the athlete, the Meet Director must securely fasten the vault runway to the floor with tape or Velcro.

#### 3. A hand placement mat may be placed on the runway (but not on the board) ONLY for vaults that require placing the hands on the runway in front of the board (Round-off or Front handspring entry.) The hand placement mat must be manufactured by a gymnastics equipment manufacturer and cannot exceed 5 cm (2 inches) in height. No other type matting is allowed.

##### a. All Meet Directors of Diamond competitions MUST provide a minimum of one manufactured Round-off hand placement mat.

##### b. If the Meet Director cannot supply the above-mentioned Round-off hand placement mats, they may allow clubs to bring their own, provided the mat meets the criteria as stated above.

##### c. If a Round-off entry hand placement mat is used, it must be placed Velcro-side down on the runway.

## Chapter 6

- E. Use of the "VAULTING BOARD SAFETY ZONE MAT" is REQUIRED for all Front handspring onto the board and Round-off entry vaults executed at Diamond division competitions. The safety zone mat must be placed snugly around the board so that there is no space between the board and the safety zone.
- No extra matting is to be placed between the Round-off entry mat (Safety Zone mat) and the vault table.
  - The Safety Zone mat may be used for all other vaults (not Front Handspring onto the board and Round-off entry vaults) for all Xcel Divisions. In this example, the Safety Zone mat does not have to be placed snugly around the board.

Example of fully matted landing area:

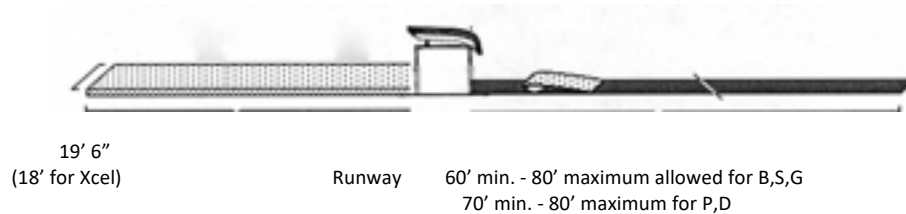

- F. Gold, Platinum, and Diamond Area required to be matted
- Specifications
    - 3 cm (1¼ inch) Base mats: If 10 cm (4") competition landing mats are used, the following 3 cm (1¼") base mats are required:
      - A minimum of 6' by 18' for Bronze, Silver, and Gold.
      - A minimum of 8' x 18' for Platinum and Diamond.
      - If 12 cm (4") or 20 cm (8") landing mats are used, base mats are not required.
    - Competition Landing Mats (CLMs):
      - For Bronze division, refer to section II.A.1. for required matting.
      - For Silver division, refer to section II.B.1.e. for required matting.
      - For Gold division, a minimum of a 6' by 12' matted area is required.
      - For Platinum and Diamond, a minimum of an 8' x 15½' matted area is required.
    - For Platinum and Diamond, whenever a 10 cm (4") supplemental mat ("throw" mat) is used in addition to the competition landing mat(s), it must be a minimum of 7' by 10'.
    - For USA Gymnastics sanctioned Xcel competitions up to and including the State Championships for all divisions, one (10-12 cm (4") or 20 cm (8")) or two (10-12 cm (4")) competition landing mats (plus the maximum allowable skill cushions) will be allowed to be placed on top of a solid-foam pit provided that this information is stated in the meet information sent to the participating clubs.
      - Landing into a "LOOSE-FOAM PIT" AREA IS NOT ALLOWED FOR COMPETITION, unless the pit area is covered by a stable (wooden or metal) surface. Exception – this is allowable if the landing surface is deemed firm by the Meet Referee and Meet Director prior to the competition.

### III. Uneven Bars

- A. Specifications
- Based on the best interest of the gymnast's safety, it is permissible to adjust the High Bar and/or Low Bar to a height which exceeds (or is lower than) the FIG specifications. Regardless of the measurement, the rails must be adjusted to a position where the spin lock may be fully tightened and meets the manufacturer's recommended safety parameters.
    - The distance (spread) between the bars may be set to the preference of the athlete, provided that after such adjustment, the bars remain within the allowances identified by the manufacturer of the apparatus.
      - For equipment that has a slider mechanism on both bars, it is strongly recommended that the low bar slider remain in the highest position, and that adjustments are made only with the high bars slider. This will expedite changing of bar sets during competition.
    - A single bar may be used for Bronze competitions, provided that the single bar meets the current low bar specifications. This information must be included in the pre-meet information.
  - Fiberglass rails with wood covering are required for all sanctioned meets.
  - No other substance besides chalk and water may be placed on the uneven bar rails.
  - Round fiberglass rails are allowed at all USA Gymnastics competitions. Diameter: 39 mm ± 1 mm.
    - AAI "soft blue rails" are allowed but must be listed in the pre-meet information.

## Chapter 6

### B. Mount specifications:

1. Platinum and Diamond: 18' minimum is allowed. (No maximum).
2. Bronze, Silver, and Gold: 6' minimum is allowed. (No maximum).

Example of fully matted landing area and mount specifications.

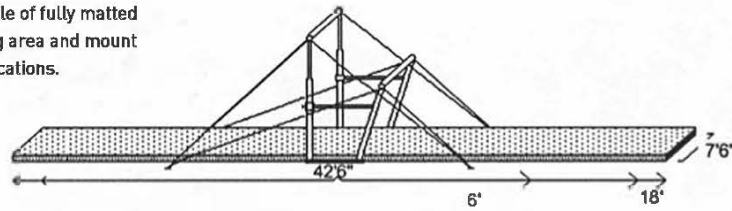

### C. Area required to be matted:

1. Xcel: The matted area under bars must be:
  - a. a minimum of 6' by 15' for Bronze.
  - b. a minimum of 6' by 24' for Silver and Gold.
  - c. a minimum of 7½' by 36' for Platinum and Diamond.
2. For Platinum and Diamond, whenever a 10 cm (4") supplemental mat ("throw" mat) is used in addition to the competition landing mat(s) for the dismount, it must be a minimum of 7' by 10'.
3. If a 10 cm (4") mat (skill cushion) is placed on the competition landing mat(s) for dismount purposes, an additional 10 cm (4") or 20 cm (8") skill cushion may be used for the purpose of protection on a release element; however, the additional skill cushion must be removed immediately after the release element is performed.
  - An alternate skill cushion made of softer foam is allowed **at invitationals and is REQUIRED at State Meets and above**. The mat must be a minimum of 4 ft. x 6 ft. and eight (8) inches high for "C" and more difficult bar releases performed in the Diamond Division ONLY (to be placed under the gymnast during the release and immediately removed). This is NOT allowed for dismounts or landings on any event.
4. When a raised surface is needed to spot release moves, it is recommended that a spotting block or folded mat be used; however, there is no penalty for standing on the board, provided that the board (or spotting device) is removed immediately after the release move is performed.
  - For Xcel competition, a 0.30 deduction will be taken if the spotting device is not removed.

## IV. Balance Beam

- A. Specifications – The height of the beam is measured from the floor to the top of the beam. For all competitions, the balance beam legs must be placed on the floor or a stable surface.
  1. Height specifications:
    - a. For all sanctioned Xcel events, the beam MUST be adjustable.
    - b. All divisions may use the beam at any height, regardless of age division; however, the height must be within a minimum of 100 cm ( $\pm 1$  cm) and a maximum of 125 cm ( $\pm 1$  cm).
  2. Padded manufactured beams are required at all sanctioned competitions.
  3. Beams with a "spring" mechanism are allowed at Xcel competitions.
  4. It is strongly recommended that padding for the Beam uprights and bases be used, if available from the manufacturer.

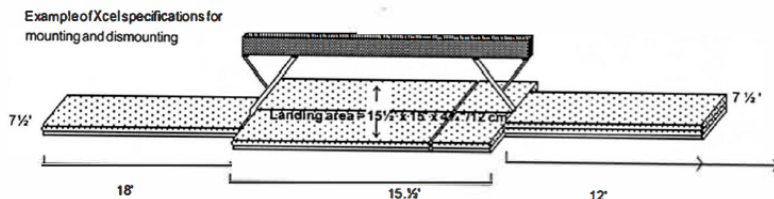

### B. Mount Specifications

1. Bronze, Silver, and Gold: 12' minimum is allowed. (No maximum)
2. Platinum and Diamond: 18' minimum is allowed. (No maximum)
3. It is strongly recommended that the entire mounting area be level.

## Chapter 6

### C. Area required to be matted:

1. Bronze, Silver, and Gold requires a minimum of 6' by 12' matted area at each end of the beam (mats may be placed sideways if the dismount is not off the end), and a minimum of 12' wide by 15½' long matted area under the beam.
2. Platinum and Diamond requires a minimum of 7½' by 12' matted area at each end, and a minimum of 15' wide by 15½' long matted area under the beam. An 8' wide mat for dismount area is recommended.
  - For Platinum and Diamond, whenever a 10 cm (4") supplemental mat ("throw" mat) is used in addition to the competition landing mat(s) for the dismount, it must be a minimum of 7' by 10'.

## V. Floor Exercise

### A. Xcel uses FIG specifications for Bronze, Silver, Gold, Platinum, and Diamond.

FIG specifications: 12 meters X 12 meters (39' 4 7/16" X 39' 4 7/16"). The measurement is from the outside of the tape or where the carpet changes color. The floor surface must be a minimum of 3.2 cm thick (1¼") to a maximum of 17.8 cm thick (7"). The top of the mat must be joined into one continuous level surface maximum of 17.8 cm thick (7").

1. When the floor exercise carpet has two colors to distinguish the border rather than a solid color with taped boundary lines, it is permissible to place small pieces of tape (of the same color as the floor area carpet) at the inside corners of the boundary to assist the gymnast's awareness of the boundary.
2. For Platinum and Diamond competitions held in outside facilities, the outside of the corners must be padded with unfolded panel mats or other such matting or carpet-bonded foam (a minimum of 3.5 cm (1 3/8 inches) high) to protect the gymnast if they go beyond the dimensions of the Floor mat. The matting must extend a minimum of 5 feet out from the edge of the boundary line and extend a minimum of 6 feet from the corner down each side of the Floor Exercise area. The corner padding should be attached (with Velcro or something similar) to the floor, foam or carpet to avoid separating or slipping. An example of the additional matting at one corner is shown below:

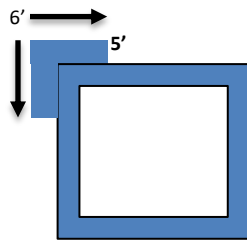

- B. A tumbling strip may be used for competition for Bronze and Silver Division, provided it is a minimum of 8' wide and 56' long. The Meet Director must indicate this in the pre-meet information.
- C. If carpeting is used, 3.2 cm (¼") pile is maximum height recommended.
- D. Rebound or spring type floors are required for all Platinum and Diamond competitions. It is strongly recommended that a spring type floor also be used for Bronze, Silver, and Gold.

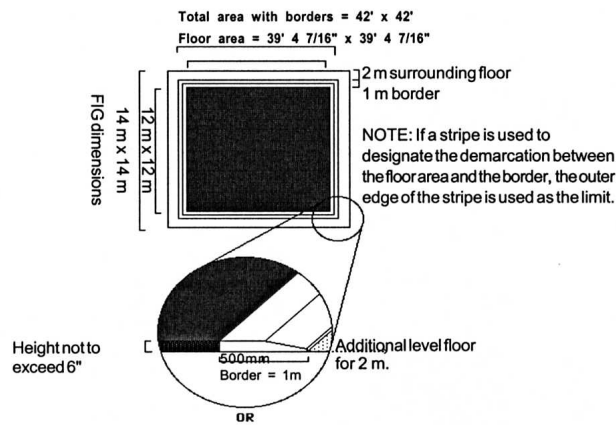

### E. Additional matting:

1. For all Xcel divisions: Up to two manufactured mats (maximum thickness of 20 cm (8")) may be placed separately on the Floor Exercise area. If the skill cushion is 20 cm (8") in thickness, it must be a minimum of 5' x 10'. A "sting" mat may also be used on top of or under the 20 cm (8") mat.

## Chapter 6

- a. Only one skill cushion or 10 cm (4") throw mat per tumbling pass may be used, with no more than two mats on the floor exercise area at any one point in time. A sting mat may be placed on top of or under the skill cushion/throw mat(s).
  - b. Whenever additional matting is placed on the Floor Exercise area and covers any portion of the boundary line(s), the mat must be clearly marked. It is recommended that athletic tape (provided by the coach) be used to mark the mats. Chalk may be used but should be removed before the next competitor. A towel should be provided by the meet director to facilitate the removal of the chalk markings.
- F. When a tumbling "strip" is used in place of a full floor exercise area in the training and/or warm-up gym, it must be constructed of the same materials as the spring floor used in the competition gym and must be a minimum of 8' wide and 60' long for Xcel. A minimum of 3' in length of additional padding (carpet bonded foam or something similar), is required at each end of a 56' tumble strip that is used for warm-up.

## Chapter 7 - Xcel General Meet Information

### I. Information Packets

- A. Include the following information and notify all eligible teams by mail or e-mail. Information should also be posted on the host club's website.
1. Name of meet, division(s) competing and date.
  2. Host Club and Meet Directors contact information.
  3. Entry fee (individual and/or team) and to whom it is payable.
  4. Spectator admission fees.
  5. Site - address, phone and map.
  6. Equipment description: Meet Directors must list all available equipment, including boards. Complete uneven bar measurements (including the full manufacturer's allowances for height and spread) must be stated in pre-meet information and on bid forms for sectional and above meets. If a tumbling strip will be used for competition for Bronze and Silver divisions, that must be stated in the pre-meet information as well.
  7. Age Divisions, if known in advance; or procedures for determining age divisions
  8. Type of awards and number to be awarded. Also include the day/time of the award ceremonies.
  9. Local hotel and transportation information, if necessary.
  10. Competition schedule
    - a. If the number of competitors is a known quantity, then specify the schedule.
    - b. If the number of competitors and age divisions is unknown, indicate that a schedule will be sent after all entries have been received. Meet Directors of invitationals are advised to accept only a predetermined number of athletes to avoid the necessity of conducting competitions during the weekdays, which would require that the athletes miss school.
    - c. Consideration should be given to avoid conflicts with major religious holidays or school when scheduling competitions.
  11. Pre-Meet information must specify if one-judge panels will be used.
  12. Pre-Meet information for Invitational meets must indicate the "type" of invitational and regulations regarding team competition.

### II. Entry Regulations and Fees

- A. All gymnastics performers and demonstrators for entertainment/demonstration purposes must be currently registered as a USA Gymnastics Athlete or Introductory Athlete Member or must be covered under the individual club's insurance policy. Any such performance must be conducted before the competition or after the entire competition is completed and no evaluation is allowed. No gymnastics performance for "exhibition" is allowed during the competition
- If any non-gymnastics performers (individual or group) will be participating, the host club is advised to obtain proof of insurance for that individual/group.
- B. Event specialists and All-Around athletes may participate in sanctioned USA Gymnastics Xcel competitions.
1. For all Xcel divisions, individual event specialist competition may be conducted up to and including regional meets, at the discretion of the respective state and regional administrative committees. Individual event specialist competitors may compete and be ranked amongst the all-around competitors; may be counted in the team score; and would receive duplicate awards in the case of a tie for event placement (ties involving Individual Event Specialists are NOT broken).
  2. Athletes who are limited in the number of events in which they can perform due to a permanent physical handicap (verified by a physician) may petition to qualify to higher level meets by achieving an average score equal to the average of the All-Around qualifying score. If the qualification is by number or percentage, such individuals could be added as additional athletes provided they achieve an average score that meets or exceeds the average score achieved by the lowest qualifier.
  3. In all sanctioned USA Gymnastics State and Regional Championships, Individual Event Specialists (IES) shall be placed first on the event she is competing using the following steps:
    - a. Organize gymnasts into squads.
    - b. Draw for starting events and flights.
    - c. Place the IES first on the event she is competing within the squad.
      - No one gymnast shall compete as the first performer of the competition in more than one event, unless there are scratches that reduce the total number of competitors in the squad to less than four (4) athletes.
- C. Non-citizens living and training in the United States, who are not current or past National Team members for a foreign country, may participate in all USA Gymnastics sanctioned Xcel events. For additional information regarding foreign athlete participation, refer to Chapter 2, page 26.



## Chapter 7

- D. In any USA Gymnastics sanctioned competition, each team/club must have at least one (1) active coach on the floor. Every coach on the floor at a sanctioned USA Gymnastics Women's competition MUST be a USA Gymnastics Women's Professional or Jr. Professional Member.
- E. Entry Fees and Deadlines
1. It is recommended that competition entries are received, AND a competition schedule published at least 4-6 weeks prior to the first day of competition. Entries should include:
    - a. Competitors name(s), USA Gymnastics Athlete Member number, birth date, citizenship and age division.
    - b. The name(s) and USA Gymnastics Professional number and Safety Certification expiration, Background Check expiration, U110 Certification and U100 Certification of all participating coaches.
    - c. ALL FEES PAID IN FULL.
    - d. An athlete is considered registered/entered in a competition only when her name is listed on the club's entry form and The Meet Director has received valid payment.
  2. Meet Directors may not refuse entries from competitors who wish to enter a competition that serves as a Sectional Meet or any competition that serves as a qualifier to State Championships and above if all registration procedures and entry fees are PAID IN FULL.
    - **EXCEPTION:** If the competition fills to maximum participant capacity, the Meet Director may consider accepting additional entries if/when space becomes available.
  3. Fees for Xcel pre-sectional qualifiers, sectional, state and regional meets should be determined by the fixed expenses (facility, awards, judging expenses, equipment rental, trainer) and divided by the guaranteed (or approximated) number of competitors.
  4. Entry fees for pre-sectional qualifiers, sectional meets and State meets are determined by the State Administrative Committee, with the approval of the Regional Administrative Committee Chairman.
    - **Entry Fees for Xcel State Meets:**  
Maximum being \$75.00 (Bronze, Silver, Gold)  
Maximum being \$85.00 (Platinum and Diamond)  
Unless approved change by the Regional Administrative Committee Chairman
  5. Entry fees for State/Regional meets are determined by the State/Regional Administrative Committee.
  6. State / Regional entry fee refunds are at the discretion of the State Administrative Committee Chair / Regional Administrative Committee Chair.
  7. Cancellation Policy - The Meet Director should make the best effort to refund all or part of the entry fee in the event that severe weather or a shortage of judges would cause a cancellation of a competition.

## Meet Formats, Number of Competitors, and Warm-up Times

### I. Meet Formats and Number of Athletes

- A. Types of Competition Formats
- The only acceptable meet formats are listed in this publication. Any ideas for new formats should be submitted to the National Xcel Committee Chairman for consideration and/or approval and possible inclusion in future *Rules & Policies*.
1. Traditional Formats:
    - a. Meets in which the open stretch, timed warm-ups and competition are conducted in one gym, with the timed warm-ups on all four events first, then competition on all four events (30-second TOUCH WARM-UPS are required).
    - b. Meets in which the open stretch and timed warm-ups on all four events are conducted in a warm-up gym, then the gymnasts move to a competition gym in order to compete on all four events. (30-second TOUCH WARM-UPS are always required when the timed warm-ups are conducted on apparatus other than the competition apparatus.)
      - The apparatus must be identical to the competitive gym, with the exception of the Floor Exercise. If a spring tumbling strip is used instead of a full Floor Exercise area, it must be a minimum of 60' long and 8' wide.
    - c. When using either of the above formats, if squads consist of 13 or more Bronze, Silver, or Gold gymnasts or 9 or more Platinum or Diamond gymnasts, the squad MAY be divided into two sub-groups for the competition warm-ups (30-second touch.) The first half takes their 30-second TOUCH WARM-UPS, and then competes; then the second half takes their 30-second TOUCH WARM-UPS and competes. TOUCH WARM-UPS on Beam and Floor may be staggered.
      - Taking the 30-second TOUCH WARM-UP in this instance is at the discretion of the personal coach and MUST be allowed, if desired.
  2. Modified Traditional FORMAT (alternating warm-up and competition):  
Meets in which the open stretch, timed warm-ups and competition are conducted in one gym in which there is only one set of apparatus. The timed warm-ups immediately precede competition on each event (this format eliminates the requirement of a 30-second TOUCH WARM-UP).

## Chapter 7

- When squads consist of 13 or more Bronze, Silver, or Gold gymnasts or 9 or more Platinum or Diamond gymnasts, the squad MAY be divided into two sub-groups. The first half takes their timed warm-ups, and then competes; then the second half takes their timed warm-ups and competes. TOUCH WARM-UPS on beam and floor may be staggered.
3. Non-Traditional Formats:
- a. Meets that have two sets of apparatus (one for competition and a duplicate set for warm-ups) either in the same or in separate gyms and that alternate the warm-ups and competition, one event at a time. (Capitol Cup type format)
    - 1) Timed warm-ups on the first event for the first four squads (Flight 1) are conducted on the warm-up apparatus, then Flight 1 goes to the competitive equipment to compete on their first event while the next four squads (Flight 2) warm-up their first event. The two flights continue to alternate between warm-ups and competition until all eight squads have completed all four events.
    - 2) 30-second TOUCH WARM-UPS are required since timed warm-ups are not conducted on the competition apparatus.
  - b. Meets which have two sets of apparatus in one gym and in which the first four squads (Flight 1) have timed warm-ups and competition on one set of apparatus, while the second four squads (Flight 2) have timed warm-ups and competition on the other set of apparatus. (Modified Capitol Cup)
    - 1) As soon as the squads in Flight 1 finish timed warm-ups on their first event and begin competition, the four squads in Flight 2 begin their timed warm-ups on their first event. Once Flight 1 completes competition on the first event, the judges move to the other set of apparatus to judge Flight 2. The two flights continue to alternate between warm-up and competition until all eight squads have completed all four events.
    - 2) Since the timed warm-ups are conducted on the competition apparatus immediately preceding the competition on the event, 30-second TOUCH WARM-UPS are not required.
  - c. For both of these non-traditional formats, the total number of athletes assigned to the corresponding Flight A and B squads cannot exceed 20 for Platinum and Diamond, and 24 for Bronze, Silver, and Gold. If there are 9 or more (Platinum and Diamond) or 13 or more (Bronze, Silver, Gold) in one of the squads, they are not allowed to split timed warm-up within their squad.
    - If the number of athletes in any one session is less than 40, the athletes may be divided into six or seven squads, leaving one or two events (either warm-up gym or competition gym) per rotation empty.
  - d. If a separate gym is used as a warm-up gym, the apparatus must be identical to the competitive gym, with the exception of the Floor Exercise. If a spring tumbling strip is used instead of a full Floor Exercise area, it must be a minimum of 60' long and 8' wide.
  - e. When at all possible, the Meet Director at USA Gymnastics sanctioned invitationals should assign teams that are split into two squads in the same flight and on "opposing" events. For example, if Team A is in two squads, Team A is assigned on Vault and Beam or Bars and Floor in the same flight, NOT Vault and Bars or Beam and Floor.
  - f. It is acceptable to have a combination of non-traditional and modified non-traditional formats in the same session.
    - Example: Use a warm-up gym and competition gym for UB, BB, and FX but have 2 VT stations in the competition gym.
- B. Determining Meet Format and Schedule
- 1. Select the type of format based upon number of athletes, number of divisions, number of gymnasiums and amount of apparatus available.
    - Bronze, Silver, and Gold meets with 73-96 gymnasts in a session and Platinum and Diamond meets with 57-80 gymnasts in a session must use some type of non-traditional format in order to remain within the 5-hour maximum time in the gym.
  - 2. Gymnasts shall be grouped in sessions (and/or squads) first according to Division.
  - 3. There is no specific maximum number of judgments PER DAY per panel of judges. The limit to the total number of competitors per day is determined by the number of gymnasts allowed per session based upon which type of format is used, along with the following time restraints. The schedule of the competition must provide for the following:
    - a. The 15-30 minute general warm-up may not begin before 8:00 A.M. (General stretch and bar settings).
    - b. Must conform to the maximum number of judgments per SESSION per panel of judges (see chart).
    - c. The competition must be scheduled to end by 10:00 PM. If the meet continues past 10:00 PM due to extenuating circumstances, the meet director must submit an explanation in writing to the RTCC, with a copy to the SACC (or RACC for Regional meets), as well as to USA Gymnastics Member Services.
      - The Meet Referee must make a note of the time infraction on the Sanction Report Form.
    - d. Gymnasts should be on the floor (including warm-ups and competition) no longer than five (5) hours when performing a single set of optional exercises in one (1) session.
      - 1) Considering the ages of the athletes in Bronze, it is recommended that the session be no longer than 2½ hours in length, including warm-up time.
      - 2) If an athlete competes in two different sessions in one day, she must be provided adequate rest time between sessions.

## Chapter 7

- e. Judges are to be provided a 30-minute break time between scheduled sessions.
4. REQUESTS TO EXCEED THE ALLOWABLE NUMBER OF JUDGEMENTS PER SESSION WILL NOT BE CONSIDERED.
- a. If the event is a state-qualifying event, additional sessions and/or days must be added.
  - b. In the case of an invitational, the Meet Director must either place clubs on a wait list or they must change their format to allow for more than four panels of judges or more than one gym.
5. Allow adequate time for awards ceremonies (depending on the number of age divisions, number of awards to be given, and if a separate awards area is available) between sessions when calculating total time for competition to ensure that no gymnast will compete after 10:00 P.M.
- C. Scheduling Guidelines
1. **BRONZE COMPETITION - Example with 60 competitors**

Traditional Format with a Timed Warm-up: Approximate Total Time			=	2 hrs. 40 min.
Open Stretch & Bar Settings	15- 30 min.	=	30 min.	
Timed Warm-up	30 seconds per gymnast	=	30 min.	
Line up, march-in	10 min.	=	10 min.	
TOUCH WARM-UP	30 seconds per gymnast	=	30 min.	
	(Maximum of 1 vault per gymnast)			
Competition	1 min. per gymnast	=	60 min.	
  
  2. **SILVER COMPETITION – Example with 60 competitors**

Traditional Format with a Timed Warm-up: Approximate Total Time			=	3 hrs. 25 min.
Open Stretch & Bar Settings	15- 30 min.	=	30 min.	
Timed Warm-up	45 seconds per gymnast	=	45 min.	
Line up, march-in	10 min.	=	10 min.	
TOUCH WARM-UP	30 seconds per gymnast	=	30 min.	
	(Maximum of 2 vaults per gymnast)			
Competition	1½ min. per gymnast	=	90 min.	
  
  3. **GOLD COMPETITION – Example with 72 competitors**

Traditional Format			=	4 hrs. 50 min.
Open Stretch & Bar Settings	30 min.	=	30 min.	
Timed Warm-up	1 minute per gymnast	=	72 min.	
Line up, march-in	10 min.	=	10 min.	
TOUCH WARM-UP	30 seconds per gymnast	=	36 min.	
	(Maximum of 2 vaults per gymnast)			
Competition	2 min. per gymnast	=	144 min.	
  
  4. **DIAMOND AND PLATINUM COMPETITION - Example with 56 competitors**

Traditional Format			=	4 hrs. 50 min.
Open Stretch & Bar Settings	30 min.	=	30 min.	
Timed Warm-up	1½ minute per gymnast	=	84 min.	
Line up, march-in	10 min	=	10 min.	
TOUCH WARM-UP	30 seconds per gymnast	=	28 min.	
	(Maximum of 2 vaults per gymnast for Platinum)			
Competition	2.5 min. per gymnast	=	140 min	
  
  5. **DIAMOND COMPETITION - Example with 56 competitors**

Traditional Format			=	5 hrs.
Open Stretch & Bar Settings	30 min.	=	30 min.	
Timed Warm-up	2 minutes per gymnast	=	112 min.	
Line up, march-in	10 min	=	10 min.	
TOUCH WARM-UP	30 seconds per gymnast	=	28 min.	
	(Maximum of 3 vaults per gymnast for Diamond)			
Competition	2.5 min. per gymnast	=	140 min	

## Chapter 7

**REFERENCE CHART: TYPES OF FORMATS, WARM-UP TIMES AND MAXIMUM NUMBER OF COMPETITORS**

Type of Format	Description	Warm-up time		Xcel Only	Combined Xcel/JO
		Bronze, Silver, Gold	Diamond, Platinum	Maximum # of competitors per session per panel of judges	Maximum # of competitors per session per panel of judges
<b>Traditional</b>	<p>Either one competition gym <b>OR</b> a warm-up and a competition gym.</p> <p>Warm-up all 4 events in the warm-up gym or in the competition gym; then compete all 4 events.</p>	<p>Bronze Division: Maximum 30 sec. timed warm-up</p> <p>Silver Division: 45 sec. timed warm-up</p> <p>Gold Division: 1 minute timed warm-up</p> <p>30-second touch is required.</p>	<p>Platinum Division: Maximum 1½ minute timed warm-up</p> <p>Diamond Division: Maximum 2 minute timed warm-up</p> <p>30-second touch is required</p>	<p>Bronze, Silver, Gold only: 72</p> <p>Diamond, Platinum only: 56</p> <p>A combination of B, S, G divisions and D, P in the same session: 64</p>	<p>A combination of B, S, or G and JO Levels 1-5: 72</p> <p>A combination of B, S, or G and JO Levels 6-10: 64</p> <p>A combination of P or D and JO Levels 1-5: 64</p> <p>A combination of P or D and JO Levels 6-10: 64</p>
<b>Modified Traditional Format #1 and Modified Traditional #2</b>	<p>Modified Traditional #1 - One set of equipment in the competition gym. No warm-up gym. Modified Traditional #2 – One Vault, one set of bars, two balance beams, and one floor exercise mat in the competition gym. No warm-up gym. Timed warm-ups immediately preceding competition on each event with continuous rotations. The judges move from the “A” beam to the “B” beam for competition. Timed warm-ups immediately preceding competition on that event.</p>	<p>Bronze Division: Maximum 30 sec. timed warm-up</p> <p>Silver Division: 45 sec. timed warm-up</p> <p>Gold Division: 1 minute timed warm-up</p> <p>No 30-second touch.</p>	<p>Platinum Division: Maximum 1½ minute timed warm-up</p> <p>Diamond Division: Maximum 2 minute timed warm-up</p> <p>No 30-second touch.</p>	<p>Bronze, Silver, Gold only: 72</p> <p>Diamond, Platinum only: 56</p> <p>A combination of B, S, G divisions and D, P in the same session: 64</p>	<p>A combination of B, S, or G and JO Levels 1-5: 72</p> <p>A combination of B, S, or G and JO Levels 6-10: 64</p> <p>A combination of P or D and JO Levels 1-5: 64</p> <p>A combination of P or D and JO Levels 6-10: 64</p>
<b>Non-Traditional (Capitol Cup)</b>	<p>2 gyms (warm-up &amp; competition)</p> <p>Timed warm-up on each event immediately preceding competition on that event.</p>	<p>Bronze Division: Maximum 30 sec. timed warm-up</p> <p>Silver Division: 45 sec. timed warm-up</p> <p>Gold Division: 1 minute timed warm-up</p> <p>Plus 30-second touch on the competitive equipment.</p>	<p>Platinum Division: Maximum 1½ minute timed warm-up</p> <p>Diamond Division: Maximum 2 minute timed warm-up</p> <p>30-second touch is required</p>	<p>Bronze, Silver, Gold only: 96</p> <p>Diamond, Platinum only: 80</p> <p>A combination of B, S, G divisions and D, P in the same session: Maximum of 80</p> <p>See page 72, I.A.3.c for squad size guidelines.</p>	<p>A combination of B, S, or G and JO Levels 1-5: 96</p> <p>A combination of B, S, or G and JO Levels 6-10: 80</p> <p>A combination of P or D and JO Levels 1-5: 80</p> <p>A combination of P or D and JO Levels 6-10: 64</p>
<b>Modified Non-Traditional (Modified Capitol Cup)</b>	<p>2 sets of equipment in the competition gym (No warm-up gym).</p> <p>Flight 1 squads compete on one set; Flight 2 competes on other set. Timed warm-ups immediately precede competition on each event.</p>	<p>Bronze Division: Maximum 30 sec. timed warm-up</p> <p>Silver Division: 45 sec. timed warm-up</p> <p>Gold Division: 1 minute timed warm-up</p> <p>No 30-second touch</p>	<p>Platinum Division: Maximum 1½ minute timed warm-up</p> <p>Diamond Division: Maximum 2 minute timed warm-up</p> <p>No 30-second touch.</p>	<p>Bronze, Silver, Gold only: 96</p> <p>Diamond, Platinum only: 80</p> <p>A combination of B, S, G divisions and D, P in the same session: Maximum of 80</p> <p>See page 72, I.A.3.c for squad size guidelines.</p>	<p>A combination of B, S, or G and JO Levels 1-5: 96</p> <p>A combination of B, S, or G and JO Levels 6-10: 80</p> <p>A combination of P or D and JO Levels 1-5: 80</p> <p>A combination of P or D and JO Levels 6-7: 80</p> <p>A combination of P or D and JO Levels 8-10: 64</p>

\*If a squad has more than one division competing, timed warm-up will be determined by the combined total number of minutes allowed for each level.

## Chapter 7

- D. COMPETITIVE FORMAT AND DRAW: Procedures after entries have been received.
1. The State Administrative Committee may decide the competitive format and draw procedures for PRE-SECTIONAL AND SECTIONAL MEETS ONLY to allow the draw for sessions to be determined by either age divisions or by club teams.
    - If the draw is conducted by teams, awards are given for all levels and/or age divisions competing in each session.
  2. The draw for sessions at State and above Championship competitions is to be determined by age divisions.
    - a. The State Administrative Committee determines specific guidelines that determine the order of competition for the age divisions and/or competitive divisions (for example, by random draw or youngest to oldest) for State meets.
    - b. Using the pre-determined State guidelines, the Meet Director and State Administrative Committee Chairman, (or other State Administrative Committee Members designated by the SACC), conduct the draw to determine the order in which the age divisions will be conducted.
    - c. The format and number of athletes for State and Regional competitions must be approved by the RJOCC and RTCC.
      - 1) For State/Regional Championships: the maximum number of gymnasts per session may be exceeded by a small percentage for special circumstances, with the approval of the RTCC, RXCC and the RACC for State Meets and by the NTCC and the NXCC for Regional Meets.
      - 2) It is the Meet Director's responsibility to contact the appropriate officers (State Meet Directors contact the SACC; Regional Meet Director contact RTCC). The State or Regional officer(s) will then contact the appropriate individuals, as stated above, for final approval.
  3. Club team competition format and draw shall be determined by the:
    - a. Meet Director for invitationals and local meets.
    - b. State Administrative Committee for the Pre-sectional qualifiers, Sectional and State meets.
    - c. Regional Administrative Committee for Regional competitions.
  4. Alphabetize teams and assign competitive numbers for each gymnast, designated by age divisions and/or competitive divisions. Each competitive division and/or age division should be designated by a specific number sequence, if possible.
    - a. If only achievement awards are given, the gymnasts are not required to compete within designated age divisions.
    - b. To assign competitor numbers, first determine all athletes in the same age division, listed alphabetically, first by team, then by last name.
  5. Determine the number of gymnasts per session based on type of competition, and allowable number of gymnasts per squad. The number of gymnasts per squad is determined by dividing the total number of gymnasts in the session by four in a traditional format, by five if a "bye" rotation is used, or by 8 in a non-traditional (Capitol Cup) format. (See Competition Formats)
  6. Draw for team placement into necessary number of squads. All members of the same age division and/or competitive division from the same team will be drawn for competitive order in the same squad in the same session.
    - a. Priority - keep competitive divisions and/or age divisions in the same session and, if possible, the same squad(s).
    - b. If warm-ups are conducted in a separate gym or on a separate set of apparatus in the same gym alternating with competition (non-traditional format), all athletes on the same team MUST be drawn in the same squad(s) within the same flight (in the same gym).
    - c. No team (club) should be drawn into more than two squads in any one session, unless the total number of gymnasts from that club exceeds the number of gymnasts that would be drawn into two squads.
      - If there are several age divisions and/or competitive divisions within the same session, teams may be drawn for placement in one or two squads.
    - d. The Meet Director should always consider the safety of the athlete first to determine the best format for the competition.
  7. Draw for starting events for each squad.
  8. Order of Events
    - a. FIG Olympic competitive order is Vault, Uneven Bars, Balance Beam, and Floor Exercise.
    - b. In the case of only one squad or 4 squads (1 panel or 4 panels of judges), the squad(s) will rotate in Olympic order.
    - c. If only 2 events compete simultaneously (2 panels of judges), it is recommended that Vault and Bars run first, followed by Beam and Floor Exercise.
  9. Draw for competitive order by taking the numbers of all gymnasts assigned to that squad and draw randomly. No one gymnast shall compete as the first performer of the competition in more than one event.
    - a. If more than one competitive division must be drawn in one squad, all athletes of the same competitive division must compete consecutively. When rotating to the next event, the first competitor of a division would be dropped to the last spot.
    - b. In the case of team invitationals in which the order of competition is drawn by team and the coach decides the competitive order of the gymnasts, all teams in the squad would compete gymnasts of one competitive division, then repeat the team order with the next competitive division of gymnasts.

## Chapter 7

10. To determine the competitive order when rotating to the next event, the number of places to be “dropped” must be applied uniformly per session and is based on  $\frac{1}{4}$  of the number of competitors in the largest squad in that session.

Examples:

6 or less gymnasts in a squad – drop one (1) spot

Gymnast 1 – V  
Gymnast 2 – UB  
Gymnast 3 – BB  
Gymnast 4 – FX

7-11 gymnasts in a squad – drop two (2) spots

Gymnast 1 – V  
Gymnast 2  
Gymnast 3 – UB  
Gymnast 4  
Gymnast 5 – BB  
Gymnast 6  
Gymnast 7 - FX

12+ gymnasts in a squad – drop three (3) spots

Gymnast 1 – V  
Gymnast 2  
Gymnast 3  
Gymnast 4 – UB  
Gymnast 5  
Gymnast 6  
Gymnast 7 - BB  
Gymnast 8  
Gymnast 9  
Gymnast 10 – FX  
Gymnast 11  
Gymnast 12

- In the case of a squad being reduced in numbers due to gymnasts scratching prior to the start of competition, it may be necessary to re-define the start order on each event for that squad only if the original number of dropped places is more than  $\frac{1}{4}$  of the number of gymnasts in that squad.
11. The order of competition (start lists) must be distributed to all coaches and judges and posted at the competition site.

## II. Meet Warm-Ups

### A. Pre-meet (timed) warm-ups

1. A 15-30 minute general/open warm-up time is required. The Uneven Bars are available to obtain settings only (Tap Swings). The apparatus is NOT available for warm-up during the general warm-up time. Marking mount distances or practicing run-up onto the board is allowed. The Floor Exercise mat and other matted and open areas may be used for locomotor warm-up activities, such as running, and for skill warm-up that can be performed in a confined space. Line drills on Floor involving simple elements are allowed; however, tumbling on the diagonal is not allowed.
2. Timed warm-ups
  - a. Rotations are determined by the following formula:
    - 1) Bronze Division: Maximum of 30 seconds X number of gymnasts per squad  
Silver Division: 45 seconds X number of gymnasts per squad  
Gold Division: 1 minute X number of gymnasts per squad  
Platinum Division: 1½ min. X number of gymnasts per squad  
Diamond Division: 2 min. X number of gymnasts per squad
    - 2) The amount of time for Vault and Floor Exercise pre-meet warm-ups is determined by the number of athletes in the largest squad of the session multiplied by the allotted time per gymnast. (see charts below).
    - 3) If a squad has more than one division competing, the timed warm-up will be determined by the combined total number of minutes allowed for each division (see charts below).

Example 1:

Squad	# gymnasts	Division	Warm-up Time
A	10	All Gold	10 min (10 x 1.0)
B	10	All Gold	10 min (10 x 1.0)
C	10	All Gold	10 min (10 x 1.0)
D	10	8 Gold, 2 Platinum	11 min (8 x 1.0 plus 2 x 1.5 min)

In Example 1, all squads would have 11 minutes (time of the largest squad) for vault and floor.

Example 2:

Squad	# gymnasts	Division	Warm-up Time
A	10	All Bronze	5 min (10 x 30 sec.)
B	10	All Silver	7.5 min (10 x 45 sec.)
C	10	All Silver	7.5 min (10 x 45 sec.)
D	10	6 Bronze, 2 Gold, 2 Platinum	8 min (6 x 30 sec. plus 2 x 1.0 plus 2 x 1.5)

In Example 2, all squads would have 8 minutes (time of the largest squad) for vault and floor.

## Chapter 7

- b. Bar settings (adjustments) are NOT included in the warm-up time; however, if a club or group of athletes chooses to block time, the clock will not stop within the block time. At all sanctioned events, only one gymnast at a time can be on the bars for any part of the warm-up period (this would include timed warm-ups and 30-second touch.)
- c. Block time will be allowed on Bars and Beam only at the discretion of each individual coach for teams that have several gymnasts in one squad. Individual gymnasts from different teams may join together to block time, if they so desire.
- 1) When using a “warm-up/compete” format (one gym and one set of apparatus) with timed warm-ups immediately preceding competition on each event, gymnasts may “block” time.
  - 2) At USA Gymnastics sanctioned competitions that use a draw for individual competitive order, the first athlete to compete MUST warm-up first, whether she chooses to block or to take individual warm-up time. If the first athlete blocks warm-up time with additional athletes in the squad, those athletes will warm-up with the first competing athlete.
  - 3) Coaches with more than one gymnast from the same team are allowed to block all of their gymnasts together on balance beam; however, this is NOT required. Individual time per gymnast is allowed with the time stopping between gymnasts. Coaches are strongly encouraged to assist each other with any adjustment of equipment, if needed.
- d. Block time for timed warm-ups is not allowed on Vault or Floor Exercise.
- \*Note: The entire squad warms up at the same time for Vault and Floor. The amount of time is calculated by multiplying the allowable warm-up time per athlete by the number of athletes in the largest squad in that session.
- At the Bronze division it is recommended that the vault warm-up be divided by the mat configurations used within the squad. For example: the first gymnast to compete uses a 16” mat stack. All gymnasts using this configuration warm-up together (30 seconds per gymnast – guaranteed one vault per gymnast). At the conclusion of the first group, the warm-up time will stop to allow coaches to set up the next mat configuration. All gymnasts using this mat configuration warm-up together (30 seconds per gymnast – guaranteed one vault per gymnast).
- e. Vault Warm-Up Procedures: The time will begin when the gymnast stands on the table to do a skill/jump off the table. If the gymnast does not do a skill/jump off the table, the time will begin when the gymnast begins running toward the table and touches the spring board. Warm-up drills i.e. “Handstand hops” and a “run by” without touching the board is NOT included in the warm-up time and will be allowed as long as performing these drills does not delay the competition. Excessive delay of “warm-up drills” when the timer is ready could result in a deduction.
- f. Floor Exercise Warm-up Procedures for meet formats that provide only one floor exercise mat for competition (or one floor and a tumbling strip):
- 1) For Bronze, Silver, and Gold divisions, squads with 12 or fewer gymnasts: warm-up all 12 gymnasts (time based on division of the gymnasts).
  - 2) For Bronze, Silver, and Gold divisions, squads with 13 or more gymnasts: warm-up half the squad, then compete. Warm-up the second half of the squad, then compete. Time is based on the division of the gymnasts.
  - 3) For Platinum and Diamond divisions, squads of 8 or fewer gymnasts: warm-up all 8 gymnasts, then compete (1 ½ minutes per gymnast for Platinum, 2 minutes per gymnast for Diamond).
  - 4) For Platinum and Diamond divisions, squads of 9 or more gymnasts: warm-up half the squad, then compete. Warm-up the second half of the squad, then compete (1 ½ minutes per gymnast for Platinum, 2 minutes per gymnast for Diamond).
  - 5) For non-traditional formats, the total number of athletes assigned to the corresponding Flight A and B squads cannot exceed 20 for Platinum and Diamond, and 24 for Bronze, Silver, and Gold. If there are 9 or more (Platinum and Diamond) or 13 or more (Bronze, Silver, Gold) in one of the squads, they are not allowed to split timed warm-up within their squad.
  - 6) With any allowable size squad: warm-up athletes between competitive routines.
    - a) When using this option, the Meet Director **MUST** assign an adult monitor to regulate the number of athletes warming up at any one point in time and to keep track of the competitive order. It is not a responsibility of the judges.
    - b) A gymnast is allowed to start warming up when there are only six more competitors ahead of her. This gives each athlete 5 turns on the Floor mat prior to her time to compete and there will be no more than five athletes warming up on the floor at any one point in time.
    - c) Example with 8 gymnasts per squad: When the first squad in Flight A warms up on Floor, the first six athletes will warm-up together (6 x 2 minutes=12 min.). Once competition begins, the 7<sup>th</sup> athlete will warm-up while judges evaluate #1 gymnast; after each subsequent routine, another athlete will be added to warm-up.
    - d) This procedure may also be used for the TOUCH WARM-UP.

## Chapter 7

- e) If a coach determines that the athletes have not had adequate warm-up time in between routines, he/she can request of the Chief Judge to either have a short block of time for a squad or partial squad to warm-up, or for the judges to slow down to allow for up to 30 seconds between exercises.
  - g. If an athlete (or team) disregards the timer and exceeds the warm-up time, the timer must report the infraction to the Meet Director or Meet Referee. This would be considered as the warning and any subsequent infraction would result in a 0.20 penalty.
  - h. Warm-up rotation order
    - 1) Traditional format: Squads start the timed warm-ups on their second competitive event and rotate in Olympic order to finish warm-ups on their first competitive event.  
EXAMPLE: Warm-up order: UB, BB, FX, V  
Competitive order: V, UB, BB, FX
    - 2) When "Bye Squads" are used, timed warm-ups must be in the same order as the competitive rotation.
  - i. If timed warm-ups are conducted in a separate Warm-up gym, all equipment (warm-up and competition) must be identical (with the exception of Floor Exercise, where a tumbling strip made with the same type springs, foam and carpet as the FX mat may be used in the warm-up gym). Each board must be marked for a specific gym and event.
  - j. If a gymnast arrives late to a competition due to circumstances beyond her control (traffic delay, weather-related), every effort should be made to allow the athlete to compete. She should be provided a safe and effective warm-up without upsetting the flow of the ongoing event. Provided that she has arrived for her designated session/age division, her scores will be valid for all individual and team rankings.
- B. Competition (30-second touch) warm-ups
- 1. The TOUCH WARM-UPS are conducted as follows:
    - a. Vault: TOUCH WARM-UPS are not controlled by time, but rather by a guaranteed maximum number of vaults per gymnast.
      - 1) Bronze Division: each gymnast is guaranteed a maximum of one (1) TOUCH WARM-UP vault.
      - 2) Silver, Gold, and Platinum Divisions: each gymnast is guaranteed a maximum of two (2) TOUCH WARM-UP vaults.
      - 3) Diamond Divisions: each gymnast is guaranteed a maximum of three (3) TOUCH WARM-UP vaults.
      - 4) Each gymnast is allowed to stand on the vault table and jump (or salto) off ONE TIME ONLY, in addition to their specific number of allowable vaults.
      - 5) After presenting to the judges, the gymnasts are allowed ONE "runback" from the board before the vault attempts are counted.
    - b. Bars: A 30-second warm-up per gymnast is allowed; the setting of the bars is NOT included in the "touch" warm-up time.
    - c. Beam: 30-seconds per gymnast.
      - TOUCH WARM-UPS on beam only may also be staggered.  
Example: For competitions using the Modified Traditional format, the first three gymnasts warm-up on beam, then athlete #1 competes. Then the 4th gymnast warm-ups while the judges evaluate the score for the first gymnast. After each subsequent routine, the next gymnast in rotation order will warm-up.
    - d. Floor Exercise: All gymnasts in the squad (or half the squad in the case of large squads) warm-up simultaneously for a time period determined by multiplying the number of gymnasts by 30 seconds. Example: 5 gymnasts will be given 2½ minutes as a group to warm-up.  
\*Note: The Meet Director may choose to use the option of conducting the warm-ups in between the competitors.
  - 2. A TOUCH WARM-UP on the competitive equipment prior to each event is required for:
    - Any competitions that do not conduct timed warm-ups on the competitive equipment.  
\*Note: Any meets that are conducted with timed warm-ups directly preceding competition on each event are NOT REQUIRED to have TOUCH WARM-UPS.
  - 3. For Traditional format meets: In the case of large squads (9 or more Platinum or Diamond gymnasts; 13 or more Bronze, Silver, or Gold gymnasts), the squad MAY be divided into two (2) groups. The first half takes a TOUCH WARM-UP and then competes; then the second half takes a TOUCH WARM-UP and competes.
    - The option to alternate competition with the TOUCH WARM-UPS (staggered touch) may also be used, at the discretion of the Meet Director.
  - 4. The TOUCH WARM-UPS are not required to be in competitive order.
    - a. The first athlete to compete must be given the opportunity to touch first.
    - b. Athletes will be allowed to take the TOUCH WARM-UP in any order to expedite the one-TOUCH WARM-UP, but each athlete must still be individually timed 30-seconds on Bars and Beam.
    - c. On vault, the athletes may warm-up in any order, but each athlete is still guaranteed the division specified maximum number of vaults (Bronze 1 vault; Silver, Gold, and Platinum 2 vaults; Diamond 3 vaults).



## Chapter 7

- d. If the TOUCH WARM-UP on Beam is staggered with warm-ups between competitive routines, the TOUCH WARM-UP must be in competitive order.
5. A gymnast is not required to take the TOUCH WARM-UP.
6. In the case of an unavoidable delay in the competition (i.e. electrical power outage, serious injury, etc.), the Chief Judge (and/or Meet Referee and Meet Director) may allow an additional TOUCH WARM-UP for those athletes who have already taken the 30-second touch but have had to wait an unreasonable amount of time. The safety of the athletes must be the primary concern.

### III. Specific Competition Procedures

Included below are rules for Athletes, Coaches, Judges, Meet Personnel and Spectators.

- A. There shall be no more than 20 minutes between the end of timed warm-ups and the start of competition (or the 30-second touch competition warm-up).
- B. Gymnasts should march from event to event, with the squad presenting itself to the Chief Judge. Exception: Competition formats that include continuous rotation do not require a formal march or presentation to the judges.
- C. ONLY competing gymnasts and their coach(es) are allowed onto the competition area, and ONLY during the session in which they are competing.
  1. The only additional people allowed on the competition floor are those directly involved with the running of the event (e.g., trainers, scorers, flashers, runners, etc.).
  2. Coaches should make child care arrangements for their offspring, unless the child is old enough to act in a volunteer capacity at the competition.
- D. At the State and Regional competitions, Platinum and Diamond gymnasts must flash the vault number of the vault that she intends to perform.
- E. If a gymnast is injured prior to or during the competition, and is unable to compete in all four events, she must touch the apparatus of the event(s) in which she is unable to compete. By receiving a score of zero or higher, she has the right to continue in the competition.
  1. If the gymnast does not present to the Chief Judge and touch the apparatus on the next event(s), she will be considered as withdrawing (scratching) from the meet and thus forfeits her right to continue but is eligible for awards on the events she competed.
  2. If a gymnast is injured during the competition and is unable to compete in any additional events, she is not required to "touch" the apparatus on the remaining events. She is, however, still eligible to receive awards on any events completed prior to withdrawing (scratching).
- F. Scoring
  1. Base score will be established at the judges' meeting at Sectional and above competitions with the use of the Technical Committee DVD; therefore, no analysis of forerunners is necessary, and all events commence at the same time.
  2. It is recommended that each judge must either independently input their score electronically or submit the score in writing on a separate score slip. If only one keypad is available per event, both judges must write their own score and both (or all four) scores should be entered electronically to ensure an accurate average score. At all sanctioned meets, there MUST be a written back-up (in the form of a verification heat sheet) to record the individual judges' scores, neutral deductions and the final average score. In order to ensure accurate results, both vaults scores should be entered into electronic scoring system, especially at qualifying and championship competitions.
  3. Open scoring is defined as either electronically flashing each judge's score or by writing each judge's score on each athlete's competitor card. The State Administrative Committee determines if open scoring is allowed at Xcel State Championships. The Regional Administrative Committee determines if open scoring is allowed at Xcel Regional Championships.
  4. Start Values are to be flashed for all Divisions at all Competitions:
    - a. Procedures for Flashing Start Values:
      - 1) Each judge should independently determine a Start Value.
      - 2) The Start Value and the final score should be recorded on the judging slip and sent via the runner to the Chief Judge.
      - 3) Each judge should flash the Start Value on the Start Value flashing unit as soon as the Chief Judge receives ALL judges' scores.
      - 4) Start Values do not have to match. A conference MAY be called to determine if the Start Value needs to be adjusted, either up or down.
      - 5) If the Start Value is changed as a result of a conference, the adjusted Start Value should be re-flashed.
      - 6) See Meet Organizational Guidelines, Clerical Committee for additional procedures for the flashing of Start Values. These guidelines can be found on the USA Gymnastics website at <https://usagym.org/PDFs/Women/Rules/Rules%20and%20Policies/w-meetorgguide.pdf>.
  5. Judges may score in 0.05 increments at all USA Gymnastics sanctioned competitions.

## Chapter 7

6. A final score of 4.00 will be awarded for any Vault, Bars, Beam or Floor Exercise routine that would result in a score equal to or less than four points (4.00). This does not include circumstances that require the event to be voided (score 0.00).
    - a. At State Meet and above, all void (optional) vaults should be unofficially scored, but not submitted, unless a video review is decisive in determining the vault was complete.
  7. Once the final average score is submitted to the scoring system, it may not be changed unless an inquiry is submitted and results in a score change.
    - a. A Chief Judge may change a score after submission to the scoring system IF a neutral deduction (such as out of bounds or overtime) was inadvertently not applied. This change must occur prior to the end of the rotation. The coach must be notified of the score change and if possible, the new score should be displayed to the public.
    - b. If a judge realizes that a gymnast was mistakenly judged using the incorrect rules for her level, the routine may be re-evaluated using the appropriate rules to determine the correct Start Value and specific compositional deductions, based on the judges' shorthand. This re-evaluation must occur within 5 minutes of the end of the competition for that session. The judging panel must notify the Meet Referee and the scoring personnel that the re-evaluation is to occur. The coach must be notified immediately of any score change.
    - c. If there is a clerical error when entering scores electronically, the score may be officially changed by the end of the session.
    - d. Recommendation that, for State Championships and above: In extenuating situations, the Meet Referee has the authority to allow a judging panel to review a routine to verify that Special Requirements were fulfilled. The coach must be notified that a review will occur. No additional deductions are allowed to be taken by a judge after the review if the special requirement(s) in question is (are) awarded.
  8. All-Around Score (AA)
    - For all Xcel divisions: All-Around is the total score for the four optional events.
  9. Individual Event Finals Score: The format and qualification procedures for the Finals competition are determined by the Meet Director and must be published in advance.
    - a. Finals may be conducted at Invitational meets.
    - b. The Individual Event score/rankings are determined during the optional All-Around competition.
  10. Team Score
    - a. The method used to calculate the team score must be described clearly in the meet information for invitational meets.
    - b. For USA Gymnastics Pre-Sectional Qualifiers, Sectionals and State club/team competitions, the State Administrative Committee shall determine the method used for determining team score. Some options are:
      - 1) Limit the number of gymnasts on a team and count all scores. (Example: 6-member team, or 3-member team, all scores count.)
      - 2) Specify the number of gymnasts on a team and count all scores but one on each event. (Example: 6-member team, 5 scores per event count.)
      - 3) Allow an unlimited number of gymnasts per team; specify number of scores per event to count.
- G. Inquiry Regulations
1. Coaches are entitled to see all scores of their individual gymnasts. Inquiries may be based only on the following:
    - Awarding of Start Value, specific "falls, neutral deductions or unusual occurrences.
    - A flash from a camera is not a valid reason to allow a gymnast to repeat a routine.
  2. The Meet Director must provide inquiry forms at a place designated at the coaches meeting. The form is available:
    - a. on the USA Gymnastics website under Women's Program at:  
<http://usagym.org/pages/home/pages/forms.html?prog=w#womens>
    - b. from your State Administrative Committee Chairman
  3. Inquiries must be submitted to the Meet Director or Meet Referee within 5 minutes of the completion of the squad's competition on that event.
    - a. No fee may be charged to submit an inquiry.
    - b. Coaches need to be aware that an inquiry allows for a second evaluation, which may result in:
      - 1) no change in score
      - 2) the score being raised
      - 3) the score being lowered.
    - c. Exception to the 5-minute to submit inquiry rule:
      - 1) If, after the completion of the last event, an athlete's AA score is a maximum of 0.10 less than the qualifying score to the State (or Regional) Championships, the coach may submit an inquiry for the gymnast's lowest scoring event in order that the athlete be considered for qualification purposes. Any change of score is official and is included in the final results.

## Chapter 7

- 2) If an athlete begins her fourth event, is injured during the routine and unable to complete her fourth event, she may petition to Regionals if her score from her first three (3) events is equal to or greater than 75% of the required petition score.  
Example: Regional Qualifying Score = 34.00. Required Petition Score = 35.00. The athlete must achieve a three-event score totaling 26.25.  
Example: Regional Qualifying Score = 35.00 Required Petition Score = 36.00. The athlete must achieve a three-event score totaling 27.00.
  - 4) These processes listed in 1) and 2) above DO NOT APPLY:
    - a) for mobility purposes, OR
    - b) if qualification to the state or regional meet is by percentage or designated number per age group.
  4. After the Chief Judge has completed the response to the inquiry, the Meet Referee or Meet Director will return the form to the coach. The coach may not approach the judge regarding the inquiry during the competition.
  5. No video review is allowed at any Xcel competition during the processing of an inquiry unless the following criteria are met:
    - a. At state meets and above, a coach can request video review by the Meet Referee and the highest rated unaffiliated judge (if video is available) in the event that the inquiry involves possibility that the judges missed an element that would affect the Start Value. The video review process may NOT be used to appeal a judgment of degree assessment, i.e. degree of casts, handstands, incomplete turns, direct connection of elements, or leg separation in leaps as well as other like skills.
      - 1) If the Meet Referee or highest rated judge is affiliated with the athlete in question, the video review will be conducted by the two highest rated unaffiliated judges, or the highest rated unaffiliated judge and a USA Gymnastics officer.
      - 2) The Meet Referee must inform the judging panel that a video review will be initiated as well as the final decision.  
Examples:
        - 1) All judges did not record a full turn on BB.
        - 2) One or more judges recorded a 1/1 twist instead of 2/1 twist on FX.
        - 3) To verify if the gymnast grasps or touches the bar with one or two hands before falling on a release element.
        - 4) To verify if the gymnast lands on the bottom of the feet first on a Vault, Uneven Bar/Beam dismounts, Beam Acro elements that finish on top of the beam (foot/feet), and Floor Exercise saltos.
  6. If administrative procedures (see below) were not properly followed on a submitted inquiry, the coach may petition the Jury of Appeals for a review within 5 minutes of the end of the rotation/competition or the return of the inquiry form whichever occurs later. At state meets and above, a video review, if available, may be considered by the Jury of Appeals. All video must be reviewed in regular-time. Slow-motion video WILL NOT be considered. Jury decision should occur within 15 minutes after the conclusion of meet and before the awards are presented.  
Procedures for Inquiries:
    - a. Properly written inquiry form by the coach.
    - b. Inquiry submitted in a timely manner to the Meet Referee or Meet Director.
    - c. Inquiry reviewed/answered by the judging panel of the event in question.
    - d. Inquiry returned to Meet Referee or Meet Director.
    - e. Meet Referee or Meet Director returns inquiry to coach by hand or by a pre-defined inquiry return procedure.
  7. At State Meets and above, video review will be allowed to consider spotting deductions.
  8. At State Meets and above, video review will be allowed to consider floor line violations.
- H. Jury of Appeals
1. The Jury of Appeals is needed to resolve problems in certain situations. The Jury of Appeals for local and state meets is comprised of the following individuals:
    - a. Meet Director (non-voting, if question relates to his/her gymnast)
    - b. Meet Referee (President of the Jury)
    - c. Chief Judge of the Event in question
    - d. If available, one USA Gymnastics representative (Elected State or higher Committee member or any Regional or National Officer)
  2. Methods of settling a case by the Jury:
    - a. Discussion
    - b. Voting on a decision
    - c. Majority vote dictates the final decision
  3. Jury of Appeals for Regional competitions shall include the Meet Director (unless affiliated with the inquiry), the Meet Referee, and the USA elected Administrative Officers.

## Chapter 7

- I. Justification for changing a score as a result of a conference, inquiry or Jury of Appeals:
1. If an error (mathematical, recording, or flashing) exists.
  2. If the average score was computed from scores that were out of range.
  3. If time and/or line violations were administered improperly.
  4. If the Jury of Appeals decides to penalize the gymnast for improper attire or behavior, or the coach for improper behavior.
- J. Audience/Spectator Regulations
1. Spectators are not allowed to enter the "field of play" competitive area. They must use only the area designated for the public.
  2. Spectators are not allowed to use flash photography during the pre-meet warm-ups or competition, as this may endanger the performing athletes.
  3. Drones are not permitted during the pre-meet warm-ups or competition, as this may endanger the performing athletes.
  4. Spectators shall not disturb the order of the meet, its competitors and its officials. Individuals causing violations shall be asked to leave the competition site.
  5. The spectators shall not carry food or drinks into the spectators' area, if so directed.
  6. Children (offspring) of coaches and/or judges should not be on the competition floor unless performing a specific duty, such as "runner" or "score flasher."
- K. Participant Regulations
- The use of cell phone for verbal conversation is PROHIBITED while on the "field of play". Coaches are permitted to record their OWN gymnasts' exercises for personal use but should not in any way interfere with the competition. Exception: Walkie-talkies for the Meet Director and host club personnel and medical personnel are allowed.
- L. Music Regulations
1. Music failures/errors that occur before the athlete has started the routine can be corrected and the correct music restarted.
  2. Procedures for music failure during the routine due to technical failure
    - a. The gymnast may continue her routine. Upon completion of the routine, gymnast and coach must decide whether to repeat the routine or accept the score that is given. The judges will post no score until that decision is made. No deduction would be taken for the absence of music.
    - b. The gymnast may stop her performance immediately and request permission from the Chief Judge to repeat her routine or to continue from the point of interruption. Once permission is given, they gymnast would perform again (either from the point of interruption or the entire exercise) after a reasonable amount of rest time. No score would be given for the partial routine.
  3. Floor music must be downloaded onto a mobile device for competition to avoid interruptions/failure to play/errors. Accessing music via cellular or internet connections is not allowed. Streaming music using Wi-Fi will not be allowed.
- M. Invitationals

All USA Gymnastics-sanctioned invitationals are governed by the *USA Gymnastics Rules and Policies*, USA Gymnastics safety guidelines and judging criteria. They may be held at the local, state, regional, national and international club level.

### 1. TYPES OF INVITATIONALS

- a. Individual or team invitationals which specify certain competitive divisions. Because all rules pertaining to that competitive division are followed, scores at such invitationals may be used to qualify to Sectionals or higher (as determined by the SAC or RAC), may be used in injury petitions and may be used for mobility purposes.
- b. Any Invitational involving athletes from foreign countries must contact the USA Gymnastics Member Services for USA Gymnastics and/or FIG procedures. For more information regarding foreign athlete participation, please refer to Chapter 2 page 26.

### 2. Rules and Procedures for Invitationals

The following deviations from USA Gymnastics Local, Sectional, and State Qualifying procedures will be allowed at any invitational:

- a. The Meet Director must publish the following in the pre-meet information:
  - 1) The age divisions and schedule for awards for each competitive division.
  - 2) Spectator admission fees and gymnast's entry fees.
  - 3) Judging Panels (1 judge, 2 judge, 4 judge, Pro Members, etc.)
- b. Teams may determine the competitive order of their gymnasts for each event.
- c. Teams may be comprised of gymnasts from different age divisions and/or different competitive divisions.
- d. Each team may block time for TOUCH WARM-UP, based on 30 seconds per gymnast for bars, beam and floor exercise. If athletes chose to block time on bars, the clock will not stop for the setting of the bars. Vault TOUCH WARM-UP is based on a specific number of vaults (1 for Bronze; 2 for Silver, Gold, and Platinum; 3 for Diamond).
- e. For all sanctioned events that have multiple sessions of the same competitive division vying for the same individual awards and team awards, athletes must be judged by the same judging panels. This does not apply to overall team awards with combined competitive divisions of competition.

## Chapter 7

- f. Non-citizens and foreign athletes are eligible for awards at all invitationals. It is not required to give duplicate awards for non-citizens/foreign athletes. A non-citizen training as a member of a U.S. club may also be included in a Club's Team Score. For Information regarding Foreign Athlete (Elite or non-elite) participation in the Jr. Olympic Program, please refer to Chapter 2, page 26.
  - g. If All-Star teams (teams comprised of athletes from different clubs/teams) are allowed to compete for team score, the meet director must indicate this in the pre-meet information.
  - h. Team Competition at Invitational Meets:  
The Meet Director may determine the format and draw for Club team competition.
    - 1) A draw will be made to determine which teams will start on each event. If there is more than one team per squad, the teams will draw for order of competition within the squad.
    - 2) Each team may determine the competitive order of its gymnasts.
    - 3) The team may be comprised of gymnasts from different age divisions and/or different competitive divisions, depending upon the type of invitational.
      - In the case of team invitationals in which different competitive divisions are competing within the same squad and receiving separate awards, all teams in the squad would compete gymnasts of one competitive division, then repeat the team order with the next competitive division of gymnasts.
    - 4) If All-Star teams (comprised of athletes from different clubs) are allowed to compete for team score, this must be indicated in pre-meet information.
    - 5) Awards for the separate age divisions and/or competitive divisions are not required.
  - i. Individual Event Finals Competition (at invitationals)
    - 1) The Meet Director, Technical Director and/or Meet Referee conduct a random draw.
    - 2) If running one event at a time, competition proceeds in Olympic order.
    - 3) If two events run simultaneously, it is recommended to conduct Vault and Bars competition first, followed by Beam and Floor Exercise.
    - 4) If two events run simultaneously, and a gymnast is drawn for the same or similar competitive order in both events, she will be dropped down in the rotation for her second event in order to provide adequate warm-up and recovery time.
3. Gymnasts going out of order - Clarification: There is no deduction for athletes competing out of order. At invitational meets that use a competitive start list, the coach may change the order if it would facilitate the use of equipment on the same setting. The Meet Director and the coaches within the squad must approve this. Please refer to *Rules & Policies*, page 112, N.2.b. & N.2.i.1) and 2).
- N. Sanction Violations – see Chapter 3, page 28-29.

## Awards

The minimum numbers and/or types of awards that must be distributed are listed below. A meet director may present more awards, but not less, than those listed. Non-citizens living and training in the United States, who are not current or past members of a foreign national team, may participate in all USA Gymnastics sanctioned Xcel events and are eligible for awards. For more information regarding foreign athlete participation, please refer to Chapter 2, page 26.

### I. Individual Awards

- A. All Xcel Divisions – the meet director is required to give a minimum of 40% of each age division for individual events and in the All-Around.
- B. Competition with Individual Event Specialists included:  
Whenever Individual Event Specialists are included in a competition, the Individual Event Specialists compete and are ranked amongst the All-Around competitors. However, if there is a tie between an Individual Event Specialist and an All-Around athlete, the tie is NOT broken. Both athletes would receive identical awards.  
Example for the vault event:
  - 1. First place athlete's score is 9.40.
  - 2. Next highest score is 9.30, earned by two athletes - one competing in the AA and the other competing as an Individual Event Specialist. This tie is not broken; both gymnasts receive the 2<sup>nd</sup> place award.
  - 3. The next highest scoring athlete earns a 9.20 and would then receive the 4<sup>th</sup> place award.
- C. If the draw for sessions is by club teams, awards for all age divisions must be presented at each session.
- D. A State Administrative Committee Chairman may request that the Regional Administrative Committee Chairman grant a deviation from these minimum recommendations based on financial conditions of the State Meet. The Regional Administrative Committee may choose to deviate from these minimum recommendations based on financial conditions of the Regional meet.
- E. If a gymnast competes in the wrong age division, her scores are invalid for the meet (may not be used for All-Around, Individual Events or Team awards); however, the score achieved may be used for level mobility.

## II. Team Awards

- A. Team awards are to be determined by the State Administrative Committee for Sectionals through State Championships and by the Regional Administrative Committee for Regional Championships.
- B. Should be awarded for each division (Bronze, Silver, Gold, Platinum, Diamond). Divisions should not be combined for Team Awards.
  1. If a state does not have enough gymnasts in one or more Divisions to have a team competition, Divisions may then be combined for team awards. In order to do this, the State Administrative Committee Chair must request permission from the Regional Administrative Committee Chair.
- C. State Team Competition for Regional Championships:
  1. Regional Championships: State Team awards may be presented (at the discretion of the Regional Administrative Committee).
  2. Club Team Awards may be presented at the discretion of the Regional Administrative Committee.

## III. Award Tie Breaking System

THIS SYSTEM IS TO BE USED WHEN AWARDING TROPHIES OR ENGRAVED MEDALS. It may also be used when awarding ribbons; however, if financial conditions permit, it is strongly recommended that duplicate awards be presented.

- A. Recognition of tied gymnasts
  1. If there is a tie for first place, BOTH GYMNASTS are champions and should be announced as such, although one will receive the second place award if duplicate awards are not possible.
  2. In the case of ties for other places, the gymnasts will be announced as being tied for that rank; however, the tie-breaking procedure determines which gymnast receives the higher award, if duplicate awards are not given.
  3. All gymnasts who tie for a place receive an award. When there is a tie for the last place awarded, the tie-breaking procedure is used to determine which gymnast will receive the award that day. Duplicate awards should be sent, within one month, to the remaining tied gymnasts.
- B. Distribution of Awards: Example of tie for first place:
  1. Award the first place medal by one of the tie breaking procedures.
  2. The second place medal is then presented to the tied gymnast.
  3. There is NO second place ranking.
  4. The third place medal is then presented to the next gymnast, and so on.
- C. Tie-Breaking Procedures for Presentation of Awards
 

For meets that cannot provide duplicate awards for placement, the tie-breaking system should be used. However, whenever there is a tie, the computer should be programmed to skip the next place (example, Tie for 1<sup>st</sup> - both gymnasts are recognized as 1<sup>st</sup> place winners, with one gymnast receiving the gold, the other silver based on the tie-breaking procedure. The next highest scoring gymnast receives the 3<sup>rd</sup> place award and no 2<sup>nd</sup> place award is presented.)

  1. Ties in the All-Around
    - a. The gymnast with the highest individual event score receives the award for the tied place.
    - b. If the gymnasts are still tied, then the gymnast with the second highest individual event score receives the award.
    - c. If the gymnasts are still tied, then the gymnast with the third highest individual event score receives the award.
    - d. If the gymnasts are still tied, then the flip of a coin in the presence of both coaches will break the tie for the award.
  2. Ties in the Individual Events
    - a. The gymnast with the highest All-Around total receives the award for the tied place.
    - b. If the gymnasts are still tied, then the flip of a coin in the presence of both coaches will break the tie for the award.
  3. Ties at Individual Event Finals (New Life) at Invitationals
    - a. The gymnast with the highest preliminary score on that event receives the award for the tied place.
    - b. If still tied, then the gymnast with the highest All-Around score from the preliminary competition receives the award for the tied place.
    - c. It is recommended that tied gymnasts receive duplicate awards. Use the above tie-breaking criteria if duplicate awards are not given for financial purposes or if duplicate awards are not available at the competition. The gymnast receiving the lower place award should be sent a duplicate award, if not available at the competition.
  4. Ties in Team Score
    - a. The team with the highest team score on a single event receives the award for the tied place.
    - b. If still tied, the team with the next highest team score on an event receives the award for the tied place.
    - c. If still tied, continue to the next highest of the events.
    - d. In case of a tie for last awarded place, both teams are to receive awards. Use the tie breaking procedures to determine which team receives the award that day and send a duplicate award to the members of the other team.

## Chapter 7

- In the case of a tie for the overall State Team Champion award, both states will be announced as co-champions.

### SELECTION OF COMPETITION HOSTS FOR QUALIFYING EVENTS

#### I. Bidding for a USA Gymnastics Competition

Bid forms for State and Regional meets are available through the State and Regional Administrative Committee Chairman.

- A. Xcel Pre-Sectional Qualifiers, Sectional and State level competitions: send a completed bid form to the State Administrative Committee Chairman.
- B. Xcel Regional competitions: send a completed bid form to the Regional Administrative Committee Chairman.

#### II. Criteria for Selection of Competition Hosts

After all the bids are received, they are ranked, and the host named. The aim is to provide equal opportunity to all applicants and to grant the event to the optimal host organization. Several factors are considered.

- A. The host organization must have successful event organizational experience and the reputation of operating according to the highest of ethical standards.
- B. The geographic location of the meet is to be rotated from time to time.
- C. The total schedule and location of state and regional meets for that year.
- D. The Meet Director MUST be a Professional Member with current Safety Certification and criminal background check, from a member club or registered business, and also must be certified as a Meet Director.
- E. The host organization and the meet director must guarantee the best organizational set-up for a quality event, according to the *USA Gymnastics Rules and Policies*.
- F. The host organization must be responsible for any financial loss it may incur.

## Chapter 8 - Junior Olympic Competitive Program

### I. Overview

The Junior Olympic program was developed with the belief that all athletes, regardless of their potential, must have a solid foundation of basic skills in order to advance safely. The program allows the gymnast to advance at her own pace, competing in more than one level in a year, if she so chooses.

In order to compete in a sanctioned competition, an athlete must be a registered USA Gymnastics Athlete Member or Introductory Athlete Member (Levels 1-2 and Xcel Bronze and Silver Divisions).

A gymnast may compete in a maximum of two (2) State meets per competitive year (one per season), either at the same or higher Level.

The Women's Junior Olympic Program is divided into three major segments; developmental, compulsory, and optional.

- A. The Developmental Levels 1 through 3 may be used as a non-competitive and achievement-oriented program for use within a gym's pre-team program, or they may be used as an introductory/recreational competitive program. States may offer State Championships for these levels.
  1. In-gym or inter-club testing.
  2. Equipment should accommodate the size of the gymnasts.
  3. Gymnasts must enter at Level 1 but may progress through the events and skills at different levels.
  4. Athletes may not skip any level (exception...Level 6 may be skipped, see below). They must advance one level at a time by scoring the minimum mobility score at any USA Gymnastics sanctioned competition (Exception: Levels 1-3 do not have a mobility score).
  5. A gymnast may not advance to Level 4 until she has completed the requirements as listed in the Entry and Mobility chart.
  6. Levels 1-3: Some states have an organized Level 1-3 competitive program with sanctioned events.
    - Contact the State Administrative Committee Chairman for information on scheduling, judging criteria, etc.
- B. The second part consists of Compulsory Levels 4 and 5. Both of these levels are progressive in nature, building upon the skills required at the previous level. Competitive opportunities are provided up to and including the USA Gymnastics State Championships.
- C. The third segment is the Optional Levels 6-10. Levels 6, 7, 8, and 9 have difficulty restrictions, while Level 10 has no restrictions in the skill choice. Composition is evaluated at Levels 8, 9, and 10. Refer to the *Junior Olympic Code of Points* for a complete explanation of Level 6-10 rules.
  1. Levels 6 and 7 have competitive opportunities up to and including State and possibly Regional Championships, depending on the needs of each Region.
  2. Additional competitive opportunities are provided for Levels 8-10, with the Level 10 competitive season culminating at the Junior Olympic National Championships, Level 9 at the Eastern or Western Championships and Level 8 at the Regional Championships.

A non-competitive educational Junior Olympic Dance Workout Program (Workouts 1-5) is also available to provide proper dance training for gymnastics. The text, DVDs and CDs can be ordered through the Merchandise Provider or from the USA Gymnastics online store at [www.usagym.org](http://www.usagym.org).

Junior Olympic competitions are conducted throughout the United States and are organized by the USA Gymnastics State and Regional Administrative Committees. Each state has the jurisdiction to determine its state calendar, according to the needs of its members. A Junior Olympic COMPETITIVE YEAR is defined as the period from August 1 through July 31. A COMPETITIVE SEASON is defined as that period from the first designated qualifying competition through the culminating Championships at each level.

### II. Age Requirements and Mobility Scores

- A. In the spirit of good sportsmanship, fairness to all athletes and competitive balance, the mobility system within the Junior Olympic Program should be followed in the manner that it was intended:
  1. Before moving up a level, every athlete should show proficiency at her current level.
  2. Once a high level of proficiency is achieved at the athlete's current level, she should strive to move up to the next level, as long as it is done safely.
  3. For athletes to repeat a level with the intent to gain an advantage over other competitors or teams IS NOT in the spirit of the Junior Olympic Program or youth sports in general.



## Chapter 8

- B. No mandate scores are permitted at any level. The Junior Olympic program's purpose is to provide competitive opportunities for all athletes, regardless of their age, ability level, or training commitment in terms of hour and/or finances.
- C. Age Determination and Regulations
1. All gymnasts must reach the minimum age for the level before competing in any USA Gymnastics sanctioned competition (see chart on the next page).  
Example: Level 3 State meet date is Dec. 1; the last Level 3 State Qualifier is November 17; the gymnast will turn the minimum age for level 3 (6 yrs. old) on November 28<sup>th</sup>. She is ineligible to compete in the qualifying meet, and therefore does not have the opportunity to qualify to the Level 3 State Championships that season.
  2. For all meets under the jurisdiction of the State or Regional Administrative Committees, the respective committee may determine the method of determining age divisions. There are basically two options:
    - a. Age groups for the season: established by specific ages (i.e., 8-10 yr. olds, 11-12, etc.).
      - 1) In this case, the age divisions should be determined and published PRIOR to the competitive SEASON and the only adjustments that may be made during the season are sub-divisions of the age groups.
        - Exception: At Level 9 or 10 State meet and below, age divisions may be combined if the number of athletes is small.
      - 2) The gymnast's age for the competitive season is determined by the date of the final day of competition at the culminating championship meet for that level. Exception: The gymnast must have reached the minimum age for her level prior to entering any qualifying competition.
        - For Levels 9 and 10 State meets and below – age is determined by the date of the last day of the State meet.
      - 3) The gymnast must compete with the age division as designated for the entire season.
      - 4) Published results MAY NOT include the gymnast's date of birth.
    - b. Age groups for each competition: established by dividing the athletes by actual birth date into approximately equal groups according to a pre-determined number of age divisions or by a pre-determined maximum number of athletes per age division.
      - Meet Directors must publish or post online the meet schedule/age divisions as soon as possible after the entry deadline.
  3. Age divisions for the Level 9 East/West and Level 10 Junior Olympic National Championships will be determined by the National Office.
    - a. The State Administrative Chairmen must report the names of all qualifiers to Level 9 and 10 Regional Meet to their Regional Administrative Chairman by the Monday following the State Championships, no later than 5:00pm local time.
    - b. The Regional Administrative Committee Chairmen will compile the data for their region and forward it to the Women's National Junior Olympic Program Director.
    - c. The Women's Junior Olympic Program Director will then determine the age divisions by dividing the athletes by birth date into approximately equal groups according to the designated number of prescribed age divisions.
      - For the 2018-2019 competitive season, only regional qualifiers (including petitioned gymnasts) who achieve the minimum qualifying score to Eastern/Western Championships or JO Nationals at State Championships will be included in age determination. Individual Event Specialists will NOT be included.
    - d. The age divisions will be published on the USA Gymnastics web site and will also be sent directly to all State and Regional Administrative Committee Chairmen.
  4. If a gymnast competes in the wrong age division, her scores are invalid for the meet (may not be used for All-Around, Individual Events or Team awards); however, the score achieved may be used for level mobility.
    - a. If, due to valid unforeseen circumstances, a gymnast is unable to compete with her designated age group, she may compete on another day (or in another session) with the approval of the SACC. She will not be eligible for ANY awards. Her score may be used for mobility or qualification purposes (if qualification is by score, not placement or percentage in a given age group) to the next meet.

## Chapter 8

### AGE/ENTRY REQUIREMENTS AND MOBILITY SCORES OVERVIEW CHART

Level	Minimum Age Requirement	Pre-requisite Scores	Previous Experience	Mobility Score to Advance to the Next Level
1–2	L. 1 - Reached 4 <sup>th</sup> birthday L. 2 - Reached 5 <sup>th</sup> birthday	None		None
3	Reached 6 <sup>th</sup> birthday	None		None
4	Reached 7 <sup>th</sup> birthday	75% proficiency at Level 1-3 on Vault, Bars, Beam, Floor	Level 4 or 5*	34.00 AA at Level 4
5	Reached 7 <sup>th</sup> birthday	34.00 AA at Level 4	Level 5 or 6*	32.00 AA at Level 5 Mobility back and forth between Levels 5 and 6 is allowed.
6	Reached 7 <sup>th</sup> birthday	32.00 AA at Level 5	Level 6 or 7*	32.00 AA at Level 6 Level 6 may be skipped if a 32.00 AA was achieved at Level 5
7	Reached 7 <sup>th</sup> birthday	32.00 AA at Level 5 or 6	Level 7 or 8*	32.00 AA at Level 7 Ind. Event Specialist: 8.5 per event
8	Reached 8 <sup>th</sup> birthday	32.00 AA at Level 7	Level 8 or 9*	34.00 AA at Level 8 Ind. Event Specialist: 8.5 per event
9	Reached 8 <sup>th</sup> birthday	34.00 AA at Level 8	Level 9 or 10*	34.00 AA at Level 9 to move to Level 10 Ind. Event Specialist: 8.5 per event
10	Reached 9 <sup>th</sup> birthday	34.00 AA at Level 9	Level 10 or Elite*	None

\* See for specifics of dropping back in the next section

#### D. Dropping Back through the Levels

1. Once a gymnast has competed in a Sectional meet, she may NOT drop back to a lower level in the same competitive season.
  - If no Sectional meet is held, then the State Administrative Committee must determine prior to the beginning of the competitive year, a designated "declaration" date for each level for such purpose. The highest level the athlete competes in a sanctioned competition after the "declaration" date designates her level for the remainder of the current season.
2. If a gymnast does not qualify to the State Championships, she may petition to drop back one Level at the beginning of the next competitive season by submitting a formal written request to:
  - a. For Levels 7 and below, the petition is sent to the State Administrative Committee Chairman, and the final decision is determined by the State Administrative Committee.
  - b. For Levels 8, 9 and 10, the petition is sent to the Regional **Administrative** Committee Chairman, and the final decision is determined by the Regional Administrative Committee.
3. Once an athlete competes in the State Championships, she is not allowed to drop back. Valid reasons would be considered by the State Administrative Committee (for Levels 7 and below) or the Regional **Administrative** Committee (for Levels 8, 9 and 10) for dropping back an athlete who has competed in a State Championships. Exception: Mobility is allowed back and forth from Levels 5 and 6 without going through the petitioning process.
  - a. These reasons would include injury, illness, or other extenuating circumstances that would have prevented the athlete from continuing to train at the level at which she had previously competed.
  - b. If a valid reason does exist, the athlete would be able to drop back only one NUMERICAL level (i.e. competed Level 8, permission to drop back one numerical level to Level 7).
4. A US Elite gymnast (an athlete who has competed as a Junior or Senior International Elite in a Classic Meet, Junior World Trails, or higher) who wants to enter the JO Program **MUST** petition to drop back to the JO program, regardless of the year of competition, by sending a "reason for change" letter FROM HER COACH to the National Junior Olympic Committee Chairman. For Information regarding Foreign Athlete (Elite or non-elite) participation in the Junior Olympic Program, please refer to Chapter 2, page 26.
  - a. All petitions must be received at least three weeks prior to the Level 10 State Meet.
  - b. The National Junior Olympic Committee will review the petition and the Chairman will notify the coach of the acceptance/denial of the petition and will copy the respective State and Regional Administrative Committee Chairmen and the Regional Technical Committee Chairman.

## Chapter 8

- c. Accepted petitioned athletes may not re-enter the Elite/Pre-Elite Program during the Elite competitive year (through Championships of the year in which she competes Level 10).
  - d. Clarification: An elite athlete dropping back into the JO program is considered a JO athlete when she enters her first USA Gymnastics sanctioned event as a Level 10 athlete AFTER the petition has been granted.
  - e. All scores obtained before the petition is granted are INVALID for qualification to State Championships and above in the current season.
5. Any gymnast who competed at the Pre-Elite level (at a Regional or National qualifier and/or Challenge competition) may choose to compete as a Level 10 in the following season, since she is considered as a Pre-Elite athlete. No petition is necessary.

### III. Alternative Competition Experience/Entry/Mobility Policies

#### Alternative Competition Experience Policies

- A. Any athlete who has previously competed in the Junior Olympic Program, but has been inactive for one or more years, must contact their State Administrative Committee Chairman for proper entry regulations. The options are:
  1. Remain at the level at which they last competed.
  2. Move up one level if they achieved the minimum mobility score during their last season.
  3. Move down one numerical level, without petitioning.
- B. Athletes whose competitive experience has been in any system (including USA Gymnastics' Xcel Program) must enter the Junior Olympic Program at Level 4.
- C. Any gymnast who has had previous competitive experience in any system (including USA Gymnastics) and who is a minimum of 14 years of age OR is at least a freshman in High School is eligible to petition by submitting a formal written request to the State Administrative Committee for entry into Level 7 and below. The petition must be accompanied by a video that demonstrates her skill level.
  - Refer to Chapter 2, page 26 for Foreign Athlete Participation in the Junior Olympic Program.
- D. States may incorporate sub-divisions within levels (such as first-year competitors and veterans or divisions based on scores achieved) or they may provide a team competition that is conducted separately from the state individual competition.
- E. Individual Event Specialists; the mobility score for advancement to the next level for Individual Event Specialists at Levels 7, 8, and 9 is 8.50 per event. Status for competing as an IES to qualify to the next higher meet must be declared at the time of entry to the qualifying meet, not during or after the conclusion of the competition
- F. Athletes who are limited in the number of events in which they can perform due to a permanent physical handicap (verified by a physician) may petition to qualify to a higher level by achieving an average score equal to the average of the All-Around qualifying score for that level. Submit petitions in a formal written request for Levels 7 and below to the State Administrative Committee Chairman and the final decision is determined by the State Administrative Committee. For Levels 8 and above, petitions are sent to the Regional Administrative Committee Chairman and the final decision is determined by the Regional Administrative Committee.
- G. Injury or illness petitions – see IV.

### IV. General Procedures for Petitions for USA Gymnastics Junior Olympic Competitions

- A. Petitions may be considered for the following reasons:
  - Injury, illness or family tragedy (e.g., death, natural disaster)
- B. If an athlete is injured prior to a qualifying meet, but is capable of competing in one, two or three events, she may compete in the qualifying meet without jeopardizing her right to petition to the next competition.
- C. The coach (or club administrator) is responsible for submitting all necessary documentation for the petition on behalf of the petitioning athlete.
- D. Entry fees for petitioned athletes should be submitted by the entry deadline. If the petition is denied, the Meet Director must refund the entry fee within three weeks.
- E. Injury Petition Forms are posted on the USA Gymnastics website under Women's Program – Forms – Petition Forms - <https://usagym.org/PDFs/Forms/Women/injury2015.pdf>.
- F. Specific procedures for State, Regional, Level 9 East/West Championships, Level 10 National Championships, are in the sections for those events.

## Competition

### I. Types of Competition

A. Overview of types of competition available to the Levels and the qualifying scores to enter:

Level	Local and Pre-Sectional	Sectional	State Championships	Regional Championships	East/ West Championships	JO Nationals
Level 1-7	X	X	X	TBD by RAC		
Level 8	X	X	X	TBD by RAC		
Level 9	X	X - 31.00 AA	X - 32.00 AA	TBD by the RAC. Level 9 and 10 qualifying scores must be approved by the NJOCC and the NTCC.	East and West: Top 7 per age division per region with a min. of 34.00 AA	
Level 10	X	X - 31.00 AA	X - 32.00 AA			Top 7 per age division/region with a min. of 35.00 AA

- The State Administrative Committee determines the qualifying scores to sectional meets and State Championships for Levels 8 and below.

### II. General Regulations

A. The State Administrative Committee (SAC) determines

1. If and when Pre-Sectional Qualifiers and/or Sectional competition will be conducted.
2. If State Meets at Level 1-3 will be conducted.
3. If sub-divisions within levels will be offered, such as first year competitors and veterans, or if a team competition will be conducted separately from the State individual competition.
4. The qualifying scores for Pre-sectional, Sectional and State meets.
5. If Individual Event Specialist Competition for Levels 6-10 will be conducted at State Championships.
6. The competitive schedule for State Meets and below.
  - a. It is recommended that a reasonable period of preparation be provided between seasons, especially between Compulsory and Optional Levels.
  - b. May conduct one annual State meet, or one Fall and one Spring State Meet at Levels 7 and below.
7. State Programs of the Year are determined annually by the SAC utilizing the following criteria:
  - a. Program exhibits excellence at multiple Junior Olympic levels with an emphasis at the highest level in the current year.
  - b. Displays good sportsmanship, team spirit and ethics.
  - c. Contributes to regional efforts (camps, clinics, congress, volunteer positions).

B. The Regional Administrative Committee determines:

1. If a Level 8 and below Regional Championships will be conducted.
2. The qualifying procedures, schedule and format of the Level 8 and below Regional Championships.
3. Regional Programs of the Year are determined annually by the RAC utilizing the following criteria:
  - a. Program exhibits excellence at multiple Junior Olympic levels with an emphasis at the highest level in the current year.
  - b. Displays good sportsmanship, team spirit and ethics.
  - c. Contributes to regional efforts (camps, clinics, congress, volunteer positions).

C. Local Meets

1. Local Meets are not under the organizational responsibilities of the State Administrative Committee; i.e., Meet Directors may set dates, entry fee and gate fee, may contract their officials (using the USA Gymnastics Contract) or by requesting the services of the State's judging contractor, and may conduct Team competition.
  - Includes dual/triangular meets between clubs, inter-squads, and invitationals.
2. May be used for:
  - a. mobility only, or
  - b. qualification to the Pre-Sectional Qualifier (if conducted), Sectional (if conducted) or State Championships, at the discretion of the State Administrative Committee.
3. May have only one club (team) competing to obtain a Sanction.

## Chapter 8

4. Must be judged by a minimum of two qualified judges per event.
    - a. Exception: One-judge panels are allowed at Compulsory levels 1, 2, 3, 4, and 5
    - b. Any local meet that directly qualifies a Level 5 gymnast to a State meet MUST be judged by a two-judge panel.
    - c. At Level 1-3, any Professional or Junior Professional member or Introductory Coach Member (Levels 1-2 and Xcel only) is allowed to judge; however, the State Administrative Committee determines if any additional criteria will be used for state qualifying competitions and State Championships.
  5. Results from local meets need to be mailed or e-mailed to the State Administrative Committee Chairman or designated state administrative committee representative and the meet director of the pre-sectional, sectional or state meet.
- D. Pre-Sectional/Sectional Qualifiers
1. Pre-sectional meets are those meets, which are designated by the State Administrative Committee as the only meets which can be used to qualify gymnasts to either Sectionals (if held) or State Championships (if held).
  2. For Sectional Meets, the State Committee, in conjunction with the Meet Director, will determine by draw the placement of teams within sessions.
  3. Must have a minimum of two clubs competing to obtain a sanction.
  4. May be used to qualify a specific number of gymnasts to the State Championships.
  5. For compulsory competition, must be judged by a minimum of one qualified judge per event.
    - Any Pre-Sectional or Sectional meet that directly qualifies a Level 5 gymnast to a State meet MUST be judged by a two-judge panel.
  6. All optional levels must be judged by a minimum of two-judge panel per event.
  7. Results from pre-sectional or sectional meets need to be mailed or e-mailed to the State Administrative Committee Chairman or the designated state administrative committee representative and the meet director of the sectional or state meet.
- E. State Championships
1. Are under the **total** jurisdiction of the State Administrative Committee and State Administrative Committee Chairman.
    - The format and number of athletes must be approved by the RJOCC and RTCC.
  2. Must be conducted for Levels 4-10 and may be conducted for Levels 1- 3 (at the discretion of the SAC).
  3. May be conducted in the fall and/or spring for Levels 1 - 7, at the discretion of the State Administrative Committee. Level 8–10 State meets must be conducted in the spring, according to the Regional and National schedule.
    - For those levels that have a Regional competition, the respective State Meet must be scheduled a minimum of three weeks prior to the Regional meet. Any deviation to that guideline must be approved by the Regional Administrative Committee Chairman.
  4. All Levels must be judged by a minimum of two qualified judges per event. The State Administrative Committee determines the number of judges per panel, selects the judges and Meet Referee, and may determine the event assignments. It is recommended by the Junior Olympic Committee that the State Administrative Committee Chairman ask the Meet Referee to make the event assignments.
  5. A present Level 8, 9 or 10 gymnast who competed at the same level the previous year and competed in the previous year's Regional Championships (and achieved a score equal to or greater than the current year's respective State Meet qualifying score) may directly enter the current year's State Meet at her respective Level.
  6. Entry Fees and Deadlines
    - a. The Meet Director must utilize the USA Gymnastics Meet Reservation System for registration (not to accept payments) and utilize the pre-printed Coaches' sign-in sheets during the competition.
    - b. The State entry fees may not exceed \$75.00 for compulsory and \$85.00 for optional levels unless approved by the Regional Administrative Committee Chairman. Entries must be postmarked a minimum of 14 days (or as per State Administrative Committee guidelines) prior to the first day of competition. A maximum fee of \$50.00 per individual entry will be charged to individuals whose entry is received after the deadline or if entry is completed improperly. Entries must include:
      - 1) Competitors and **accepted** petitioned athletes' name(s), USA Gymnastics Athlete Member number, birth date, citizenship and age division.
      - 2) The name(s) and USA Gymnastics Professional number, Safety Certification expiration, Background Check expiration, and U100 certification of all participating coaches.
      - 3) ALL FEES PAID IN FULL.
      - 4) An athlete is considered registered/entered in a competition only when her name is listed on the club's entry form and the Meet Director has received valid payment.
      - 5) Any athlete who has qualified to a State, Regional, East/West or National Championships will be allowed to participate, provided that they are capable of performing at least one event. In this case, they must present and touch each apparatus in order to receive a score of "zero" at the events in which they are unable to compete. The scores received by this individual may also contribute to the team score.

## Chapter 8

- 6) Entry fees for pre-sectional qualifiers, sectional meets and State meets are determined by the State Administrative Committee, with the approval of the Regional Administrative Committee Chairman.
  - 7) State / Regional entry fee refunds are at the discretion of the State Administrative Committee Chair / Regional Administrative Committee Chair.
7. PETITIONS TO STATE CHAMPIONSHIPS (ALSO SEE GENERAL RULES FOR PETITIONS - CHAPTER 8, PAGE 80.)
- a. NO petitions are allowed if the qualification to the State Meet is by a percent of a percent or a designated number of each age division and not by score.
  - b. If a gymnast is unable to compete at the Sectional or any local State-qualifying Meet (or cannot compete in the All-Around at State Meet) due to injury or illness prior to or during the State Meet), her coach may petition the State Administrative Committee Chairman to allow the athlete to directly enter the State Championships, if the following requirements are met and documentation is included with the petition form:
    - 1) A photocopy of the results of one sanctioned meet from the current season showing a score which is equal to or greater than the state qualifying score.
      - If the gymnast competed at the same level in the previous season and qualified to the State meet or above, she may petition with the previous year scores from State or above meets.
    - 2) Written request from the coach.
    - 3) A Licensed Medical Professional's written verification of the illness or injury and date of release for return to gymnastics activity.
  - c. If an athlete who is unable to compete at any Sectional or local State-qualifying meets in the current season (or cannot compete AA at such events) due to injury or illness and is also lacking scores from last year's season due to injuries but has previously qualified to and competed in the State or above level competitions at the same level, an injury petition may be considered under special circumstances by the State Administrative Committee Chairman. If necessary, the Regional Technical Committee Chairman and the Regional Junior Olympic Committee Chairman will be consulted. The petition must include:
    - 1) A copy of meet results from the previous State/Regional/National competition with scores, which are at least one point higher than the current State qualifying score.
    - 2) A current video.
    - 3) Written request from the coach or parent.
    - 4) A Licensed Medical Professional's written verification of the illness or injury and date of release for return to gymnastics activity.
  - d. Petition Deadlines: petitions to the State Meet must be received no later than the Wednesday after the last qualifying meet is held. Petitions must be sent to the State Administrative Committee Chairman by e-mail, Express Mail, or FAX.
    - 1) The petitioner will be notified of the approval or denial of the petition by the State Administrative Committee Chairman no later than one week before the competition.
    - 2) The State Administrative Committee Chairman will notify the Meet Director of the approval or denial of the petition no later than one week before the competition.
    - 3) If a petition is accepted but the gymnast is unable to compete, the coach **MUST** notify the Meet Director and the State Administrative Committee Chairman.
8. Awards for state meets and above must be ordered from the national medal company by the State Administrative Committee Chairman (or designee). Awards should be ordered a minimum four (4) weeks before the competition.
9. Results from State Meets need to be mailed or e-mailed to the Regional Administrative, and Technical Committee Chairmen, Regional Meet Director, and the State Administrative Committee Chairman of the respective state within 72 hours.
10. The State Meet Director must send a Financial Report to the State Administrative Committee Chairman within 60 days of the completion of the meet.
- F. Regional Championships
1. Are under the total jurisdiction of the Regional Administrative Committee.
    - a. The format and number of athletes must be approved by the Regional Junior Olympic Committee Chairman and Regional Technical Committee Chairman.
    - b. Entry fees for Junior Olympic Regional Championships are determined by the Regional Administrative Committee and must be approved by the National Administrative Committee Chairman.
    - c. The Regional entry fees may not exceed the National entry fee unless approved by the National Administrative Committee Chairman.
    - d. The Meet Director must utilize the USA Gymnastics Meet Reservation System for registration (not to accept payments) and utilize the pre-printed Coaches' sign-in sheets during the competition.
  2. Must be conducted for Level 9 and 10 and may be conducted for Level 8 and below (at the discretion of the Regional Administrative Committee).

## Chapter 8

- a. Level 9 and 10 Regionals are conducted in April a minimum of three (3) weeks prior to Level 9 East/West and Level 10 Nationals. The date (or option of dates) is determined by the National Junior Olympic Committee. Any deviation from this guideline must be approved by the Junior Olympic Program Director.
  - b. The scheduling of Level 8 Regionals and below (if held) is at the discretion of the Regional Administrative Committee.
  - c. The Regional Administrative Committee determines if the Level 8, 9 and 10 Regional Championships will be conducted separately, or all held the same weekend.
3. Team competition by club team is not allowed at Regional Championships.
  4. State team competition may be conducted as a separate competition (with a designated number of athletes qualifying by rank order) or as part of the individual competition in which each state designates which individual's scores will count toward the State team score.
  5. If a state has no qualifiers to Regionals, the gymnast with the highest AA from the State Championships (from any of the age divisions) will be invited to compete at the Regional meet, regardless of the score.
  6. Must be judged by a minimum of two qualified judges per panel. The Regional Administrative Committee selects the judges and determines the number of judges per panel.
  7. If the number of athletes in one age division requires that two sessions of competition be conducted, the Meet Director shall conduct a random draw by team to fill the sessions.
  8. Regional Meet Directors must send regional meet information to the State Meet Director, with copies to the Regional Junior Olympic Committee Chairman, Regional Technical Committee Chairman and Regional Administrative Committee Chairman at least one week prior to the State Championship.
  9. Entry forms and fees for Junior Olympic Regional meets must be filed and paid (with a club/company check) to the USA Gymnastics designated official at the qualifying meet, (unless there is an electronic entry system in place), who will forward them to the Meet Director of the next level meet. Entries for Regional meets must be submitted to the designated USA Gymnastics personnel at the respective State Championships. Each club must be prepared to pay for all their qualifiers with one company check per level.
10. Petitions to Regional Championships at Levels 8, 9 and 10 (Also See General Rules for Petitions Chapter 8, page 80)
    - a. There are NO petitions to Junior Olympic Level 8 Regional Championships if qualification is by a percentage or by specific number.
    - b. If a gymnast is unable to compete at the State Meet (or cannot compete in the All-Around at State Meet) due to injury or illness prior to or during the State Meet, her coach may petition the Regional Technical Committee Chairman (or Regional Technical Assistant, if so designated) to allow the athlete to directly enter the Regional Championships, if the following requirements are met and documentation is included with the petition form:
      - 1) A photocopy of at least one pre-state, sanctioned meet results from the current season (at the level to which they are petitioning) showing a score at least one point (1.00) greater than the regional qualifying score OR
        - a) Level 8: If the gymnast competed in the previous year's Junior Olympic Level 8 Regional Championships and her Optional AA score was at least one point (1.00) greater than the current Regional qualifying score, she may submit her last year's Regional score as her pre-State meet score.
        - b) Level 9: A Level 9 gymnast may submit her previous year's Regional or East/West score as her pre-State meet score if her Optional AA score was at least one point (1.00) greater than the current year's Level 9 Regional qualifying score.
        - c) Level 10: A Level 10 gymnast may submit either her previous year's Regional or National score as her pre-State meet score if her Optional AA score was at least one point (1.00) greater than the current year's Level 10 Regional qualifying score.
      - 2) A Licensed Medical Professional's written verification of the illness or injury and date of release for return to gymnastics activity.
      - 3) Written request from the coach.
    - c. If an athlete who is unable to compete at the State Championships (or cannot compete AA at State Meet) due to injury or illness is also lacking scores from both the current and last year's season due to injuries but has previously qualified to and competed in either Level 9/10 Regionals, Level 9 East/West, or Level 10 JO Nationals, an injury petition for the same level may be considered under special circumstances by the Regional Technical Committee Chairman and the Regional Junior Olympic Committee Chairman. If necessary, the State Administrative Committee Chairman and the National Chairmen (Junior Olympic Committee and Technical Committee) will be consulted. The petition must include:
      - 1) A copy of the meet results must be included with the petition form. The scores from the previous Regional/National competition must be at least one point higher than the current Regional qualifying score.
      - 2) A current video that is sent to both Regional officers.
      - 3) A Licensed Medical Professional's written verification of the illness or injury and date of release for return to gymnastics activity.

## Chapter 8

- d. The Regional Technical Committee Chairman (or her appointee) will handle the petition, in consultation with the Regional Junior Olympic Committee Chairman and the State Administrative Committee Chairman. If an agreement cannot be reached, the Regional Technical Committee Chairman will make the decision.
  - e. Special Considerations for Petitions to Level 9 or 10 Regional Championships  
Any athlete currently competing Level 9 or 10 who has no Level 9 or 10 scores from the current season due to injury, but who had competed at or qualified to an Elite Challenge or Classic in the previous season, may petition to Level 9 or 10 Regionals. The injury petition will be considered under special circumstances by the Regional Technical Committee Chairman and Regional Junior Olympic Committee Chairman. If necessary, the State Administrative Committee Chairman, as well as the National Chairmen (Junior Olympic Committee and Technical Committee) may be consulted. The petition form must be accompanied by the following:
    - 1) A copy of her Elite scores from the previous season.
    - 2) A current video must be sent to the two Regional officers.
    - 3) A Licensed Medical Professional's written verification of the illness or injury and date of release for return to gymnastics activity.
  - f. Deadlines for Petitions to Regional Championships:
    - 1) Coaches must notify their Regional Administrative Committee Chairman AND their Regional Technical Committee Chairman by FAX or e-mail NO LATER THAN the Monday following the State Championships of any athletes they intend to petition to their Regional meet.
    - 2) The complete Injury/Illness petition form (found online at <https://usagym.org/PDFs/Forms/Women/injury2015.pdf>). The request in writing from the coach and official results are due the Monday following the State Championships by 5:00pm local time. All other required documents (physician's note) are due the Wednesday following the State Championships by 5:00pm local time.
      - Also send a copy to the State Administrative Committee Chairman.
    - 3) The Entry form and fees must be sent directly to the Meet Director, specifically marked as "Petition pending". If the petition is denied, the Regional Technical Committee Chairman will contact the Meet Director, who will refund the entry fee.
    - 4) If the gymnast was injured at the State Championships, the entry fees and form should be given to the USA Gymnastics officer who is designated to collect Regional entries at the State meet. (Fees will be returned within three weeks if the petition is not accepted.)
    - 5) The petitioner will be notified of the approval or denial of the petition by the Regional Technical Committee Chairman a minimum of one week prior to the Regional meet.
    - 6) The Regional Technical Committee Chairman will notify the Meet Director of the approval or denial of the petition.
    - 7) If a petition is accepted, but the gymnast is unable to compete, the coach must IMMEDIATELY notify both the Meet Director and the respective Regional Technical Committee Chairman.
11. Awards:  
The Regional Administrative Committee Chairman orders the awards for the Regional meets a minimum of 4 weeks prior to competition from the national medal company.
- a. The USA Gymnastics National Office is financially responsible for the following Regional awards:
    - 1) 1st - 3rd per age division for Junior Olympic Level 10
    - 2) 1st - 3rd per age division for Junior Olympic Level 9
  - b. Since Regional competition for Level 8 and below is not required, the Regions are financially responsible for all awards.
  - c. The Regional Administrative Committee will determine whether the Meet Director or the Regional Administrative Committee has the financial responsibility for the medals needed beyond the above listed medals.
12. Results of Regional Meets must be e-mailed within 72 hours to:
- a. For Level 8 or below, if held: State Administrative Chairmen in that region, the Regional JO, Technical, and Administrative Chairman.
  - b. For Level 9: State Administrative Committee Chairmen in that region, the Regional JO, Technical and Administrative Committee Chairmen, the Meet Director of the respective Eastern or Western Championships and the Junior Olympic Program Director at the National office.
    - 1) Level 9 Regional Meet Directors (or designated USA Gymnastics Regional officer) must e-mail the meet results to the Women's Junior Olympic Program Director (National office) no later than 24 hours after the completion of the meet.
    - 2) Also include a list of the qualifiers, plus two alternates to the East/West and/or Junior Olympic National Championships.
  - c. For Level 10: The State Administrative Committee Chairmen; in that region the Regional JO, Technical and Administrative Committee Chairmen, the JO National Meet Director and the Junior Olympic Program Director at the National office.



## Chapter 8

- 1) Level 10 Regional Meet Directors (or designated USA Gymnastics Regional officer) must e-mail the meet results to the Women's Junior Olympic Program Director (National office) no later than 24 hours after the completion of the meet.
  - 2) Also include a list of the qualifiers, plus two alternates to the East/West and/or Junior Olympic National Championships.
13. The Meet Director must send the Financial Report form within 45 days (or otherwise designated time) to the Regional Administrative Committee Chairman
- G. Eastern/Western Championships – Level 9
1. General Regulations
    - a. Are under the jurisdiction of the USA Gymnastics National Office and the Junior Olympic Committee. The Meet Directors of the Level 9 Eastern and Western Championships shall contact the Junior Olympic Program Director for specific information on:
      - 1) Schedule
      - 2) The Draw, Squads, and Rotations
      - 3) All technical matters of the meet
      - 4) Financial responsibilities of local organizing committee and USA Gymnastics
    - b. Are conducted annually in late April/early May.
    - c. The assignment of judges is the responsibility of the National Technical Committee Chairman and the Junior Olympic Technical Director and is based on the recommendations of the eight Regional Administrative Committees.
    - d. Judged by four-judge panel per event, with no more than two judges from the same region on a panel.
      - The Regional Administrative Committees will lend financial support to ensure that four (4) judges from each region will be assigned. Each Regional Administrative Committee will contribute \$400.00 to the respective Eastern or Western Meet Director.
  2. Qualification to Eastern/Western Championships
    - a. Eastern/Western age divisions will be determined separately. 16 age divisions for East and West.
    - b. The top seven (7) All-Around athletes in each of the 16 age divisions from each of the four regions will compete as Regional Team members, provided they scored a minimum of 34.00 AA at the Regional Championships.
      - Note: Any gymnasts who tie for 7<sup>th</sup> place will attend East/West Championships and will be outfitted as the other competitors. The tie-breaking procedures will be used to determine which gymnast's score will count for Regional team score and which will compete as an Individual. She will not be eligible to receive a Regional Team Award.
      - In the event of a 3-way tie for 7<sup>th</sup> place All-Around in any age division, the tie breaking procedures will be applied to determine the rank order of the athletes. The 9<sup>th</sup> place athlete will NOT be eligible for East/West Championships unless there is space available in another region in that age division.
    - c. If any region is unable to field a team of seven gymnasts per age division, the open slots will be filled based upon the Regional Team results from the previous year.
      - 1) If one spot needs to be filled, the 8<sup>th</sup> place athlete from the region whose regional team won that respective division the previous year will fill the spot. All athletes from the 1<sup>st</sup> place region who might be involved in a tie for 8<sup>th</sup> place will be used to fill the empty spots before any other region's athletes are assigned.
      - 2) If more than one spot needs to be filled in an age division and there were no ties in the 1<sup>st</sup> place region, the next individual added is the 8<sup>th</sup> place athlete from the region whose regional team placed second in the previous year.
      - 3) Only athletes from the regions that placed 1<sup>st</sup> and 2<sup>nd</sup> in the specific age division the previous year may fill the incomplete squads.
      - 4) If an athlete competes with another region, the Region becomes a designated All-Star team. The scores from the entire squad, regardless of region, will count towards the Regional All-Star team score. In the event of a tie for seventh place, the tie-breaking procedures will be applied to determine the rank order of the athletes and the eighth place athlete will NOT be eligible to receive an All-Star team award.
    - d. Foreign Athlete Eligibility – refer to Chapter 2, page 26.
    - e. There are NO PETITIONS to Eastern or Western Championships.
    - f. All competitors and first alternates will receive a tank leotard from their region to be worn in the competition. Each region will be designated by a specific color. The gymnasts will also receive a competition warm-up uniform from GK Elite Sportswear.
      - 1) The first alternate and the next several athletes in rank order should be measured at Regionals in the event that more than one athlete in an age division is injured or ill and cannot compete at Eastern/Western Championships. The second and subsequent alternates do not receive apparel unless they move into the 1<sup>st</sup> alternate position prior to the week of the competition.
      - 2) Apparel will be ordered for the first alternate (and any ties for 1<sup>st</sup> alternate) from each region in each age division. The apparel will be distributed to only those first alternates in attendance.

## Chapter 8

- 3) The apparel for alternates who do not attend will be used as replacements for any problem sizing for the competitors. If, following the competition, there are warm-up uniforms remaining, they will be sent to the alternates who did not attend either by the Regional Administrative Committee Chairman, Regional JO Committee Chairman, or by the National office. The distribution of the remaining competitive leotards supplied by the Region is at the discretion of the respective Regional Administrative Committee Chairman.
3. Entry Forms and Fees
  - a. Prior to the Regional Meets, the Meet Director of the Eastern and Western Championships must send meet information for all qualifiers and alternates to the four respective Regional Meet Directors. In addition, a copy of the meet information must be sent to the Junior Olympic Program Director.
  - b. Entry forms and fees for the Level 9 Eastern and Level 9 Western Championships are collected at the Regional Championships by the Regional Administrative Committee Chairman or the USA Gymnastics designated official, who forwards them by EXPRESS MAIL (unless there is an electronic entry system in place), along with the meet results to the Meet Director of the respective Eastern or Western Championships.
    - 1) Clubs must be prepared to pay the entry fee (maximum of \$135 per athlete) with one company check at the Regional meet.
    - 2) Coaches ARE REQUIRED to register online through the USA Gymnastics Meet Reservation System. The number of Credentialed Coaches for East/West Championships and/or Junior Olympic National Championships allowed per club are as follows:
      - 1-4 athletes participating – maximum of 3 credentialed coaches allowed on the field of play
      - 5-9 athletes participating – maximum of 4 credentialed coaches allowed on the field of play
      - 10+ athletes participating – contact the Women’s Junior Olympic Program Director for coach credentials
    - 3) Upon approval of the Women’s Junior Olympic Program Director, additional credentials may be purchased for \$100.00. Payment is due at the time of the request.
  - c. Results and the names of qualifiers must be sent by e-mail to the Junior Olympic Program Director at the USA Gymnastics National office.
  - d. Entry fees are not refundable with less than ten days notice prior to the meet.
    - 1) If an athlete who is qualified to Level 9 East/West is unable to compete due to an injury/illness and is replaced by the alternate, the Meet Director will refund the injured/ill athlete’s entry fee.
    - 2) If no replacement is made, there will be no refund.
4. Injury Replacements
  - a. If a qualifier is injured prior to the Eastern or Western Championships, the alternate gymnast from her region and age division will replace her. Replacements will be allowed up to the start of the competition on the first event for each flight; however, the alternate must take the position and squad of the injured athlete.
  - b. If the injury/illness occurs within 48 hours of the start of competition, the first alternate will be contacted. If she is not present at the meet and is unable to participate, the second alternate, if in attendance at the meet, may be called upon to replace the injured/ill athlete. If the second alternate is not present at the meet site, there will be no replacement.
  - c. Any gymnast who is qualified to enter the Eastern or Western Championships, but is unable to compete, is REQUIRED to IMMEDIATELY notify the Women's Junior Olympic Program Director and their Regional Administrative or JO Committee Chairman. The Junior Olympic Program Director will then notify the alternate and the Junior Olympic Eastern or Western Meet Director.
    - DO NOT CONTACT THE COACH OF THE ALTERNATE GYMNAST DIRECTLY!
5. Format for Level 9 Eastern and Western Championships
  - a. Individual Event, All-Around and Regional Team competition will be conducted for the sixteen age divisions, as designated. There will be twenty-eight gymnasts per age division, plus any ties for the last qualifying place.
  - b. Each session will have two age divisions, one in each flight. Each flight has four squads of seven (or eight if there is a tie), with each squad representing one of the four regions
  - c. There are two acceptable formats for Level 9 Eastern or Western Championships competition:
    - 1) Non-traditional (Capitol Cup) with one warm-up and one competition gym:
      - a) The warm-up and competition gyms must have identical equipment. (A tumbling strip is acceptable in the warm-up gym, provided that it is a minimum of 60' long and 8' wide and is identical to the competitive Floor Exercise).
      - b) The first four squads (Flight 1) warm-up their first event in the warm-up gym, then move to the competition gym, while the second four squads (Flight 2) warm-up their first event. The two flights continue to alternate warm-ups and competition until all eight squads have completed all four events.
    - 2) Modified non-traditional with two competitive gyms, side by side, each with a full set of equipment for all events.
      - a) The four squads in each flight are assigned to warm-up and compete in a specific gym. The first flight warms up their first event, then competes (no TOUCH WARM-UP required), While the 1<sup>st</sup> flight is

## Chapter 8

- competing, the other four squads (Flight 2) warm-up their first event. The two flights continue to alternate warm-ups and competition until all eight squads have competed in all four events.
- b) Once all four squads in Flight 1 have finished competing their first event, the judges move to the other gym to judge Flight 2. The judges continue to alternate between gyms until both flights have competed in all four events.
- 3) Medical personnel must be present during ALL competition.
- d. The Level 9 Eastern and Western Championships will be a four (4) day event, conducted on the same dates at different sites.
    - 1) **Thursday** - Training Day - The facility must be available one day prior to the competition for training purposes and coaches' meeting. A welcome banquet/party and a coaches' meeting is conducted in the evening.
      - a) Structured workout will be assigned by region, with consideration for geographic location and time change.
      - b) The warm-up and competition gyms must have identical equipment. (A tumbling strip is acceptable in the warm-up gym provided that it is a minimum of 60' and 8' wide and is identical to the competitive Floor Exercise).
      - c) Medical personnel must be present for ALL training and competition.
    - 2) **Friday** - Day One: First session: Competition for Junior 1 and 2; Second session: Competition for Junior 3 and 4; Third session: Competition for Junior 5 and 6
    - 3) **Saturday** - Day Two - First session: Competition for Junior 7 and 8; Second session: Competition for Senior 1 and 2; Third session: Competition for Senior 3 and 4
    - 4) **Sunday** - Day Three - First session: Competition for Senior 5 and 6; Second session: Competition for Senior 7 and 8
    - 5) There are no Individual Event Finals competition.
6. Awards
    - a. The National Office orders the awards from the National Awards Supplier.
    - b. For each age division, the top eight (8) in the All-Around and Individual Events will be given awards.
      - Ties are not broken; duplicate awards are presented.
    - c. Regional Team scores for each age group will be determined by the top four (4) scores per event.
      - All members of the first and second place Regional Teams will receive a team award.
    - d. An overall Regional Team score will be determined by the following method:
      - 1<sup>st</sup> place team 4 pts.
      - 2<sup>nd</sup> place team 3 pts.
      - 3<sup>rd</sup> place team 2 pts.
      - 4<sup>th</sup> place team 1 pt.The overall team champions will be announced following the last session on Sunday.
7. Results and Reports
    - a. Results including All-Around, Individual Event and Team scores/ranking will be sent to the Junior Olympic Program Director.
      - The JOPD will distribute these results to the Women's Program sub-committees by e-mail or by posting on the USA Gymnastics website.
    - b. The Meet Director must send the Financial Report form within 60 days (or otherwise designated time) to the USA Gymnastics Women's Junior Olympic Program Director.
- H. Junior Olympic National Championships – Level 10
1. General Regulations
    - a. Are under the jurisdiction of the USA Gymnastics National Office and the Junior Olympic Committee. The Meet Director of the Junior Olympic National Championships shall contact the Women's Junior Olympic Program Director for specific information on:
      - 1) Schedule
      - 2) The Draw, Squads and Rotations
      - 3) All technical matters of the meet
      - 4) Financial responsibilities of local organizing committee and USA Gymnastics
    - b. Are conducted annually in early to mid-May.
    - c. Individual competition as well as regional team competition is conducted for the twelve age divisions at the Junior Olympic National Championships.
    - d. Judged by four-judge panels per event; four judges from each region (2 for Juniors and 2 for Seniors).
      - The eight Regional Administrative Committees will lend financial support to assist with travel costs for judges. Each region will contribute \$300 to the Meet Director.
  2. Qualification to Junior Olympic Nationals

## Chapter 8

- a. The top seven (7) All-Around gymnasts in each of the twelve age divisions from each of the eight regions will compete as Regional Team members at the Junior Olympic National Championships, provided that they achieve a minimum of 35.00 AA at the Regional meet.
    - 1) Any gymnasts who tie for 7<sup>th</sup> place will attend the Junior Olympic National Championships and will be outfitted as the other competitors. The tie-breaking procedures will be used to determine which gymnast's score will count for Regional team score and which will compete as an Individual.
    - 2) If the next athlete eligible for an invitation to compete in Junior Olympic National Championships in a given age division places first on any event(s) at her Regional Championships and does not qualify to the Junior Olympic National Championships from her All-Around ranking, she is eligible to compete in JO Nationals on that/those event(s) only. She will be assigned in the squad with her region. Her score will NOT count toward the team score.
      - In the case of a tie, the tie breaking procedures will be applied to determine the rank order of the athletes. The lower ranking athlete will be assigned to another region that has space available in that age division.
  - b. If any region is unable to field a team of seven gymnasts per age division, the open slots will be filled based on a percentage of eligible athletes in each region, in each age division.
  - c. If an athlete competes with another region, the Region becomes a designated All-Star team. The scores from the entire squad, regardless of region, WILL count towards the Regional All-Star team score. In the event of a tie for seventh place, the tie-breaking procedures will be applied to determine the rank order of the athletes and the eighth place athlete will not be eligible to receive an All-Star team award.
  - d. Foreign Athlete Eligibility – refer to Chapter 2, page 26.
  - e. There are NO PETITIONS to the Junior Olympic National Championships.
  - f. All competitors (including ties for 7<sup>th</sup> place) and first alternates will receive a competitive leotard, a scrunchie, and a warm-up uniform from GK Elite Sportswear. The region will also provide a tank leotard for training day.
    - 1) The first alternate and the next several athletes in rank order should be measured at Regionals in the event that more than one athlete in an age division is injured or ill and cannot compete at JO National Championships. The second and subsequent alternates do not receive apparel unless they move into the 1<sup>st</sup> alternate position prior to the week of the competition.
    - 2) Apparel will be ordered for the first alternate (and any ties for 1<sup>st</sup> alternate) from each region in each age division. The apparel will be distributed to only those first alternates in attendance.
    - 3) The apparel for alternates who do not attend will be used as replacements for any problem sizing for the competitors. If, following the competition, there are warm-up uniforms remaining, they will be sent to the alternates who did not attend either by the Regional Administrative or JO Committee Chairman or by the National office. The distribution of the remaining training leotards supplied by the Region is at the discretion of the respective Regional Administrative Committee Chairman.
3. Entry Forms and Fees
- a. Prior to the Regional Meets, the Meet Director of the Junior Olympic National Championships must send meet information for all qualifiers and alternates to the eight Regional Meet Directors. In addition, a copy of the meet information must be sent to the Junior Olympic Program Director and Regional Administrative Committee Chairmen.
  - b. Entry forms and fees for the Junior Olympic National Championships are collected at the Regional Championships by the Regional Administrative Committee Chairman or the USA Gymnastics designated official, who forwards them by EXPRESS MAIL (unless there is an electronic entry system in place), along with a hard copy of the meet results to the Meet Director of the Junior Olympic National Championships.
    - 1) Clubs must be prepared to pay the entry fee (maximum of \$135 per athlete) with one company check at the Regional meet.
    - 2) Include the names of any 1<sup>st</sup> or 2<sup>nd</sup> alternates on the club entry form, but fees are not paid unless the athlete is called to replace a qualifier.
    - 3) Coaches ARE REQUIRED to register online through the USA Gymnastics Meet Reservation System. The number of Credentialed Coaches for East/West Championships and/or Junior Olympic National Championships allowed per club are as follows:
      - 1-4 athletes participating – maximum of 3 credentialed coaches allowed on the field of play
      - 5-9 athletes participating – maximum of 4 credentialed coaches allowed on the field of play
      - 10+ athletes participating – contact the Women's Junior Olympic Program Director for coach credentials
    - 4) Upon approval of the Women's Junior Olympic Program Director, additional credentials may be purchased for \$100.00. Payment is due at the time of the request.
  - c. Results and the names of qualifiers must be sent by e-mail to the Junior Olympic Program Director at the USA Gymnastics office.

## Chapter 8

4. Injury Replacements
  - a. If a qualifier is injured prior to the Junior Olympic National Championships, the alternate gymnast from her region and age division will replace her. Replacement will be allowed up to the start of the competition on the first event for each flight; however, the alternate must take the position and squad of the injured athlete.
  - b. If the injury/illness occurs within 48 hours of the start of competition, the first alternate will be contacted. If she is not present at the meet and is unable to participate, the second alternate, if in attendance at the meet, may be called upon to replace the injured/ill athlete. If the second alternate is not present at the meet site, there will be no replacement.
  - c. Any gymnast who is qualified to enter the Junior Olympic National Championships, but is unable to compete, is REQUIRED to IMMEDIATELY notify the Junior Olympic Program Director and their Regional Administrative or JO Committee Chairman. The Junior Olympic Program Director will then notify the alternate and the Junior Olympic National Meet Director.
    - DO NOT CONTACT THE COACH OF THE ALTERNATE GYMNAST DIRECTLY!!
5. Format for Junior Olympic National Championships
  - a. There will be one combined Junior Olympic National Championships for the Junior and Senior age divisions, conducted concurrently at one site.
  - b. Competition will be conducted with two competition gyms (Junior and Senior) that include 2 sets of each apparatus.
    - 1) There will be three sessions per day in each of the two gyms.
    - 2) Each session will be a separate competition for one age division and includes eight (8) Regional teams, each consisting of seven (7) athletes.
    - 3) The competition will be run in Modified Capitol Cup Format. Refer to the chart in Chapter 9, page 101. Flight One squads compete on one set of equipment; Flight Two squads compete on the other set of equipment. Timed warm-ups immediately precede competition on each event. No 30-second touch is required.
  - c. The Junior Olympic National Championships will be a three (3) day event.
    - 1) **Friday** - Training Day - The facility must be available one day prior to the competition for training purposes. A welcome banquet/party is scheduled for Friday evening.
      - a) Structured workout will be assigned by region, with consideration for geographic location and time change.
      - b) Medical personnel must be present for ALL training and competition.
    - 2) **Saturday** - Optional Competition for Junior A,B,C and Senior A,B,C.
    - 3) **Sunday** - Optional Competition for Junior D,E,F and Senior D,E,F.
    - 4) There are NO Individual Event Finals competition.
6. Awards (See Chapter Nine, Page 113)
  - a. The National Office orders the awards from the National Awards Supplier.
  - b. Top 10 All-Around and Individual Event winners for each of the twelve age divisions are determined by the Optional competition. No Individual Event Finals will be held.
    - Ties are not broken; duplicate awards are presented.
  - c. Team Awards:
    - 1) All members of the top three (3) winning teams in each age division will receive an award. Team scores are determined by adding the top four (4) scores on each event.
    - 2) An overall Regional Team Champion will be determined based upon the rankings of the Regional Teams in each age division. Points will accumulate based upon the following team placement per age division:
 

1 <sup>st</sup> Place	8 Points	5 <sup>th</sup> Place	4 Points
2 <sup>nd</sup> Place	7 Points	6 <sup>th</sup> Place	3 Points
3 <sup>rd</sup> Place	6 Points	7 <sup>th</sup> Place	3 Points
4 <sup>th</sup> Place	5 Points	8 <sup>th</sup> Place	1 Point
  - d. Junior Olympic National Team: The top four AA gymnasts per age division will be designated as the Junior Olympic National Team and will receive plaques and will be invited to attend a Junior Olympic National Team Training Camp. In the case of a tie for fourth place, the tied athletes will qualify to the Junior Olympic National Team.
    - 1) If an eligible non-citizen athlete places in the top four (4) AA, she will receive the award for her AA placement; however, she is not eligible to become a member of the US Junior Olympic National Team.
    - 2) In this instance, the next US citizen in rank order is placed on the Junior Olympic National Team.
    - 3) Refer to Chapter 2, page 32 for eligibility requirements.
7. Results and Reports
  - a. Results including All-Around, Individual Event and Team scores/ranking will be sent to the Junior Olympic Program Director.

## Chapter 8

- The WJOPD will distribute these results to the Women's Program sub-committees by e-mail or by posting on the USA Gymnastics website.
  - b. The Meet Director must send the Financial Report form within 60 days (or otherwise designated time) to the USA Gymnastics Women's Junior Olympic Program Director.
8. The Meet Director of the National Championships shall remain in close contact with the Junior Olympic Program Director for assistance and guidance.

### Apparatus Requirements Junior Olympic Competitions

#### I. General Considerations

- A. Athlete safety guidelines, as listed in the *USA Gymnastics Safety Handbook*, should always be considered.
- B. It is recommended that there be a clearance of 5' to 6' from one apparatus to any other. This includes corresponding mat areas or any other obstruction, i.e., other apparatus, walls, pillars, etc.
- C. It is recommended that there be a minimum of a 20-foot ceiling height for all USA Gymnastics sanctioned competitions.
- D. Equipment specifications, including vault runway thickness, must be published in the pre-meet information.
- Exact bar measurements must be listed on bid forms for sectional and above meets.
- E. Levels 1-3 non-competitive gymnasts may set the equipment to facilitate the exercise. Level 1 and 2 meets must follow the same standards used at Level 3.
- F. All equipment and matting used at a USA Gymnastics-sanctioned competition must be manufactured by a recognized equipment manufacturer.
- G. Matting Height Specifications:
1. COMPETITION LANDING MATS FOR VAULT, BARS AND BEAM (See V. for Floor Exercise matting)
    - a. JUNIOR OLYMPIC:
      - 1) One 10-12 cm (4") competition landing mat is required; a second 10 -12 cm (4") may be placed on top of the required mat for compulsory and optional competition. If a second 10-12 cm (4") mat is used for Optional Levels 6-10, it must be a minimum of 7' by 10'.
      - 2) Maximum height is 24 cm (9").
      - 3) 20 cm (8") competition landing mats are also allowed (but are not required).
        - a) For vault, if 20 cm (8") mats are used, it is recommended that the Meet Director make every effort to also provide one 10-12 cm (4") competition landing mat.
        - b) For Bars and Beam, in order to use a 20 cm (8") mat, the apparatus must be capable of being raised to the FIG maximum height allowance (High Bar – 246 cm; Beam – 125 cm).
      - 4) A 3 cm (1¼") base mat must be used if a 10 cm (4") competition landing mat is used. When using 12 (4") – 20 cm (8") mats, a base mat is not required.
        - The 3 cm (1¼") base mat may be placed underneath or on top of the competition landing mat.
      - 5) The area under the apparatus and/or in the landing area must be matted with competition landing mats that are uniform in height.
    2. Supplemental Matting (Skill Cushions) For Vault, Bars and Beam (See V. for Floor Exercise matting)
      - a. JUNIOR OLYMPIC
        - 1) Up to 24 cm (9") of any combination of supplemental matting [skill cushion(s), throw mat and/or sting mat(s)] is allowed in addition to the maximum allowable competition landing surface of 24 cm (9").
        - 2) Whenever a full 20 cm (8") skill cushion is used, it must be a minimum of 5' x 10'; however, it is recommended that it be as close as possible to the same dimensions as the competition landing mat.
        - 3) Whenever a 10 cm (4") supplemental mat ("throw" mat) is used for Levels 6-10, it must be a minimum of 7' by 10'.
        - 4) Any dimension of sting mat is allowed.
- H. Springboard/Mounting Specifications
1. Only unaltered manufactured vaulting boards are approved for sanctioned USA Gymnastics competitions. The height of the board (22 cm ± 1.5 cm) is measured from the floor to the highest point of the board, including the covering. All springboards meeting the stated specifications are allowed, however, it is required to provide a springboard with coil springs. Exceptions:
    - a. Levels 1-4 may use a manufactured "Junior" vaulting board.

## Chapter 8

- b. Levels 1 and 2 athletes may use alternative springboard apparatus, provided they are manufactured by a gymnastics equipment manufacturer. If an alternative springboard is used at a Level 3 or higher USA Gymnastics sanctioned event, the vault is considered VOID. The apparatus should resemble the shape of a vault board, with a maximum of 38 cm (15 inches) at the high end and a maximum of 10 cm (4 inches) at the low end. The surface producing the “spring” may be other than the traditional coil springs, such as an air bladder or small trampoline bed.
  - c. All levels may also use a manufactured mat shaped like a springboard (Mount trainer/mount mat).
2. Plywood is not permitted underneath the board. (Exception: see Collegiate rules)
  3. All Meet Directors must arrange to have boards that accommodate gymnasts of varying weights. Any boards brought in to a competition must be assigned to an event and must be available to all gymnasts in that session for warm-up and competition. The following 3-4 spring configurations for the springboard have been approved and may be utilized in USA Gymnastics sanctioned competitions:

4 COIL SPRING PLACEMENT (OPTION 1)



4 COIL SPRING PLACEMENT (OPTION 2)



4 COIL SPRING PLACEMENT (OPTION 3)



3 COIL SPRING PLACEMENT



4. Junior Olympic levels: A board used to mount Bars or Beam may be placed on the competition landing mat(s) (one or two 10-12 cm (4”) mats or one 20 cm (8”). The board may also be placed on the allowable competition landing mats plus the supplemental matting of 5-10 cm (sting mat or 4” throw mat type skill cushions).
  - a. At Levels 1 - 5, any manufactured mats, skill cushions or padded spotting/skill blocks may be used for mounting purposes.
  - b. At Levels 6-10, a manufactured mount mat or folded panel mat may be used instead of a board for mounting purposes.
  - c. The board (or mount mat) must be removed as soon as possible after the gymnast has mounted.
  - d. At Levels 1-5, the mount mat (not a board) may be placed on a 20 cm (8”) skill cushion for the purpose of mounting.
  - e. At levels 6-10, the board (or mount mat) MAY NOT be placed on a 20 cm (8”) skill cushion for the purpose of mounting.
5. For Junior Olympic levels, the gymnast may stand (without a board) on one or two 10 -12 cm (4”) landing mats or one 20 cm (8”) mat (with or without a 3 cm (1¼”) base mat placed under or on top of the competition landing mat.)
  - a. The gymnast may also stand on an "up to 20 cm (8-inch) skill cushion" (sting, throw mat or 20 cm (8”) skill cushion) that is placed on the competition landing mat(s).
  - b. At Levels 1- 5, any combination of competition landing mats and skill cushions may be used to facilitate the mount.

## Chapter 8

- When performing the Level 3 uneven bar mount of glide swing, then back hip pullover, the athlete may stand on a panel mat, spotting block, or board placed on the above matting to initiate the jump into the glide swing. This mat/board must be removed as soon as possible after the jump into the glide swing.
- I. Make sure all reasonable safety measures are considered. Examples:
1. Each competitive area must have its own physical space and may not overlap with another competitive area.
  2. There cannot be any obstructions on the Floor Exercise Area.
  3. There must be sufficient room for mounting, dismounting, and vaulting areas.
  4. Procedures for the removal of blood and disinfection of the apparatus: A solution of 1 part bleach and 10 parts water (or an Anti-viral spray disinfectant) should be available for the removal/disinfection of blood from the apparatus or matting.
- J. Conversion for inches to centimeters:
- |         |                       |   |       |
|---------|-----------------------|---|-------|
| Approx. | $\frac{3}{4}$ inch    | = | 2 cm  |
|         | 4 inches              | = | 10 cm |
|         | $4\frac{1}{2}$ inches | = | 12 cm |
|         | 8 inches              | = | 20 cm |
|         | 9 inches              | = | 24 cm |

## II. Vault

### A. Specifications:

#### 1. Junior Olympic Program:

The vaulting table is required for Levels 4-10. The maximum vaulting table height is 135 cm ( $\pm 1$  cm). If using a vault table with two uprights, both must be set at the same height. The height is determined by measuring the distance from the floor to the center top of the vault table.

- a. The center top of the vault table is determined by measuring 68 cm from the back of the vault table. Tape of any kind, including athletic tape, may NOT be placed on top of the table at any time during warm-up or competition.
- b. If the vault runway is on a raised platform, the vault table must also be placed on a raised surface of the same height and the measurement of the vault table should be taken from the runway surface to the center top of the vault table, rather than from the floor.
- c. All manufactured models of the vault table (including "retro-fit" tables that are inserted into the uprights of the old horse) are allowed for competition, provided that they are capable of being adjusted to the various height specifications allowed for Junior Olympic athletes. Matting must be used to cover the upright of the vault table as well as to cover any weights placed on the vault base for stability.
- d. Levels 4-5: All age divisions may use the vault table at any manufacturer setting.  
Levels 6-7: All age divisions may use the vault table at any manufacturer setting, with a maximum of 135 cm ( $\pm 1$  cm).  
Levels 8-10: All age divisions may use the vault table with a minimum setting of 115 cm ( $\pm 1$  cm) and a maximum of 135 cm ( $\pm 1$  cm).
- e. Level 3 apparatus: Mat stack – minimum of 81 cm (32 inches) in height ( $\pm 2.5$  cm or 1 inch). Any combination of competition landing mats, skill cushions OR port-a-pit may be used; however, the top layer of matting MUST be a minimum of a 10 cm (4-inch) skill cushion or the port-a-pit, plus two additional 20 cm (8") skill cushions to allow for 102 cm (40") and 123 cm (48") heights ( $\pm 2.5$  cm or 1 inch). An inflatable mat may also be used in the configuration of matting; however, the uppermost landing surface must be a minimum of a 10 cm (4-inch) skill cushion.
  - 1) All age divisions may use any of the three choices of heights.
  - 2) The mat stack may be placed on top of a solid foam pit.
  - 3) A tape line must be placed at 81 cm (32") from the front edge of the landing surface (placed so that the far edge of the tape is at 81 cm (32")). The tape line should also extend down the side of the mat.
  - 4) An additional mat (minimum of 10 cm (4")) must be placed on the floor behind the mat stack.
  - 5) All mats used in forming the mat stack must be a minimum of 5' wide and 10' long.
  - 6) An unfolded panel mat (or any manufactured matting to facilitate a firm surface) may be placed on top of the uppermost surface of the mat stack/resi pit if necessary to provide a more stable landing surface. This mat must cover the entire uppermost surface
  - 7) The top surface may be either a "squared" (standard 8" mat corners) or "curved" (similar to a table trainer) on the front edge.

### B. Runway Specifications

1. Measurement is from the front of the vaulting table. The runway should be a clearly defined area that provides a flat, consistent surface, free of cracks, obstructions or seams. The Meet Director must provide a tape measure, which must be extended the length of the runway in order for the gymnasts to find the point at which to start their run. Minimum width of the runway should be the width of the board.



## Chapter 8

- a. Lengths:
    - 1) A 76' minimum, 82' maximum runway is allowed for Levels 8, 9 and 10.
    - 2) A 70' minimum, 80' maximum runway is allowed for Level 6 and 7.
    - 3) A 60' minimum, 80' maximum runway is allowed for Levels 1- 5.
  - b. Thickness: A minimum thickness of 3.5 cm (1 and 3/8 inches) ( $\pm$  .3 cm or 1 /8 in.) is required for the vault runway at all Optional levels (6-10).
  - c. Athletic tape **or** Velcro strips (**no chalk**) may be placed on the vault runway, provided that such markings are removed no later than the end of the rotation. Maximum width of Velcro strip or athletic tape is 5 cm (2"), maximum length is 3 feet.
  - d. For the safety of the athlete, the Meet Director must securely fasten the vault runway to the floor with tape or Velcro.
2. Junior Olympic: A hand placement mat may be placed on the runway (but not on the board) ONLY for vaults that require placing the hands on the runway in front of the board (Round-off or Front handspring entry.) The hand placement mat must be manufactured by a gymnastics equipment manufacturer and cannot exceed 5 cm (2 inches) in height. No other type matting is allowed.
- a. All Meet Directors of Level 8 and above competitions MUST provide a minimum of one manufactured Round-off hand placement mat.
  - b. At East/West and JO National Championships, only the Round-off hand placement mats manufactured by the equipment company that is supplying the apparatus will be allowed. Clubs may not bring their own mats.
  - c. If the Meet Director cannot supply the above mentioned Round-off hand placement mats, they may allow clubs to bring their own, provided the mat meets the criteria as stated above.
  - d. If a Round-off entry hand placement mat is used, it must be placed Velcro-side down on the runway.
- C. Use of the "VAULTING BOARD SAFETY ZONE MAT" is REQUIRED for all Front handspring onto the board and Round-off entry vaults executed at the Junior Olympic Levels 8, 9 and 10. The safety zone mat must be placed snugly around the board so that there is no space between the board and the safety zone.
1. No extra matting is to be placed between the Round-off entry mat (Safety Zone mat) and the vault table.
  2. The Safety Zone mat may be used for all other vaults (not Front Handspring onto the board and Round-off entry vaults) at all Junior Olympic levels. In this example, the Safety Zone mat does not have to be placed snugly around the board.

Example of fully matted landing area:

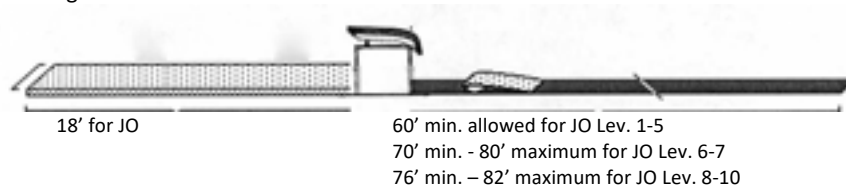

- D. Area required to be matted:
1. Junior Olympic
    - a. 3 cm (1¼ inch) Base mats: If 10 cm (4") competition landing mats are used, the following 3 cm (1¼") base mats are required:
      - 1) A minimum of 6' by 18' for Levels 4/5.
      - 2) A minimum of 8' x 18' for Level 6/7/8/9/10.
      - 3) If 12 cm (4¾") or 20 cm (8") landing mats are used, base mats are not required.
    - b. Competition Landing Mats (CLMs):
      - 1) For Levels 1-3, refer to the Junior Olympic Compulsory book for required matting at each level.
      - 2) For Levels 4-5, a minimum of a 6' by 12' matted area is required.
      - 3) For Levels 6-10, a minimum of an 8' x 15½' matted area is required.
    - c. For Levels 6-10, whenever a 10 cm (4") supplemental mat ("throw" mat) is used in addition to the competition landing mat(s), it must be a minimum of 7' by 10'.
    - d. For USA Gymnastics sanctioned Junior Olympic competitions up to and including the State Championships for all levels, one (10-12 cm (4") or 20 cm (8")) or two (10-12 cm (4")) competition landing mats (plus the maximum allowable skill cushions) will be allowed to be placed on top of a solid-foam pit provided that this information is stated in the meet information sent to the participating clubs.
      - Landing into a "LOOSE-FOAM PIT" AREA IS NOT ALLOWED FOR COMPETITION, unless the pit area is covered by a stable (wooden or metal) surface. Exception – this is allowable if the landing surface is deemed firm by the Meet Referee and Meet Director prior to the competition.

## Chapter 8

### III. Uneven Bars

#### A. Specifications

1. Junior Olympic specifications:
  - a. Based on the best interest of the gymnast's safety, it is permissible to adjust the High Bar and/or Low Bar to a height which exceeds (or is lower than) the FIG specifications. Regardless of the measurement, the rails must be adjusted only to a position that locks-in with a dual locking mechanism that meets the manufacturer's recommended safety parameters.
  - b. The distance (spread) between the bars may be set to the preference of the athlete, provided that after such adjustment, the bars remain within the allowances identified by the manufacturer of the apparatus.
    - For equipment that has a slider mechanism on both bars, it is strongly recommended that the low bar slider remain in the highest position, and that adjustments are made only with the high bar slider. This will expedite changing of bar sets during competition.
  - c. A single bar may be used for Levels 1, 2 and 3 competitions; provided that the single bar meets the current Low bar specifications.
2. Fiberglass rails with wood covering are required for all sanctioned meets.
3. No other substance besides chalk and water may be placed on the uneven bar rails.
4. Round fiberglass rails are allowed at all USA Gymnastics competitions. Diameter: 39 mm  $\pm$  1 mm.
  - AAI "soft blue rails" are allowed at JO competitions but must be listed in the pre-meet information.

#### B. Mount Specifications:

1. Levels 6-10: 18' minimum is allowed. (No maximum).
2. Levels 1-5: 6' minimum is allowed. (No maximum).

Example of fully matted landing area and mount specifications.

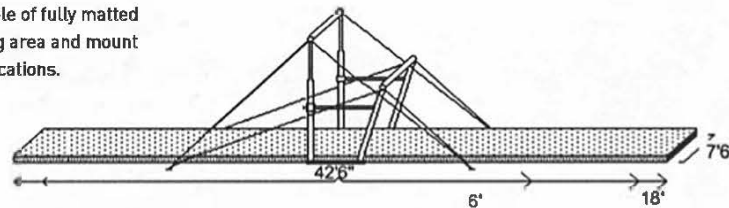

#### C. Area required to be matted:

1. Junior Olympic: The matted area under bars must be:
  - a. a minimum of 6' by 15' for Levels 1-3.
  - b. a minimum of 6' by 24' for Levels 4 and 5.
  - c. a minimum of 7½' by 36' for Levels 6-10.
2. Mount distance minimums:
  - a. Levels 1-5 – 6' minimum (no maximum)
  - b. Levels 6-10 – 18' minimum (no maximum)
3. For Levels 6-10, whenever a 10 cm (4") supplemental mat ("throw" mat) is used in addition to the competition landing mat(s) for the dismount, it must be a minimum of 7' by 10'.
4. If a 10 cm (4") mat (skill cushion) is placed on the competition landing mat(s) for dismount purposes, an additional 10 cm (4") or 20 cm (8") skill cushion may be used for the purpose of protection on a release element; however, the additional skill cushion must be removed immediately after the release element is performed.
  - An alternate skill cushion made of softer foam is allowed at invitationals and is REQUIRED at State Meets and above. The mat must be a minimum of 4 ft. x 6 ft. and eight (8) inches. It may be used for bar releases ONLY (to be placed under the gymnast during the release and immediately removed). This is NOT allowed for dismounts or landings on any event.
5. When a raised surface is needed to spot release moves, it is recommended that a spotting block or folded mat be used; however, there is no penalty for standing on the board, provided that the board (or spotting device) is removed immediately after the release move is performed.
  - For Junior Olympic competition, a 0.30 deduction will be taken if the spotting device is not removed.

## Chapter 8

### IV. Balance Beam

- A. Junior Olympic height specifications - The height of the beam is measured from the floor to the top of the beam. For all competitions, the balance beam legs must be placed on the floor or a stable surface.
- For all sanctioned Junior Olympic events, the beam **MUST** be adjustable.
  - All Levels may use the beam at any height, regardless of age division; however, the height must be within a minimum of 100 cm ( $\pm 1$  cm) and a maximum of 125 cm ( $\pm 1$  cm).
  - Padded manufactured beams are required at all sanctioned competitions.
  - Beams with a "spring" mechanism are allowed at Junior Olympic competitions.
  - It is strongly recommended that padding for the Beam uprights and bases be used, if available from the manufacturer.

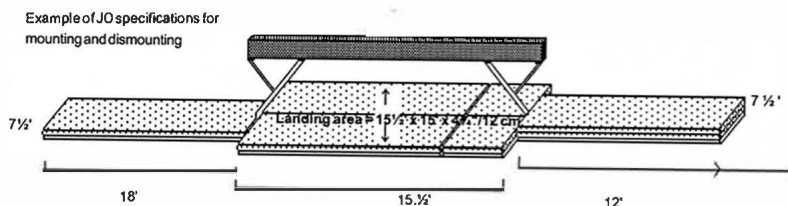

- B. Mount Specifications
- Levels 6-10: 18' minimum is allowed. (No maximum)
  - Levels 3-5: 12' minimum is allowed. (No maximum)
  - It is strongly recommended that the entire mounting area be level.
- C. Area required to be matted:
- Junior Olympic
    - Levels 6-10: requires a minimum of 7½' by 12' matted area at each end, and a minimum of 15' wide by 15½' long matted area under the beam. An 8' wide mat for dismount area is recommended for Levels 7 and above.
      - For Levels 6-10, whenever a 10 cm (4") supplemental mat ("throw" mat) is used in addition to the competition landing mat(s) for the dismount, it must be a minimum of 7' by 10'.
    - Levels 1 - 5 requires a minimum of 6' by 12' matted area at each end of the beam (mats may be placed sideways since the dismount is not off the end), and a minimum of 12' wide by 15½' long matted area under the beam.

### V. Floor Exercise

- A. Junior Olympic uses FIG specifications for Levels 6 – 10. FIG specifications: 12 meters X 12 meters (39' 4 7/16" X 39' 4 7/16"). The measurement is from the outside of the tape or where the carpet changes color. The floor surface must be a minimum of ¼" thick (3.2 cm) to a maximum of 7" thick (17.8 cm). The top of the mat must be joined into one continuous level surface.
- When the floor exercise carpet has two colors to distinguish the border rather than a solid color with taped boundary lines, it is permissible to place small pieces of tape (of the same color as the floor area carpet) at the inside corners of the boundary to assist the gymnast's awareness of the boundary.
  - For level 7 – 10 competitions held in outside facilities, the outside of the corners must be padded with unfolded panel mats or other such matting or carpet-bonded foam (a minimum of 3.5 cm (1 3/8) inches high) to protect the gymnast if they go beyond the dimensions of the Floor mat. The matting must extend a minimum of five (5) feet out from the edge of the boundary line and extend a minimum of six (6) feet from the corner down each side of the Floor Exercise area. The corner padding should be attached (with Velcro or something similar) to the floor, foam or carpet to avoid separating or slipping. An example of the additional matting at one corner is shown below:

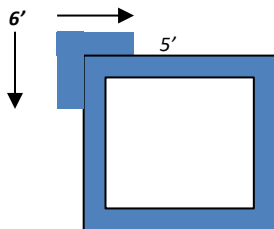

## Chapter 8

- B. Levels 3 and 4 may use a 36' X 36' area. Levels 1-3 may use a tumbling strip area provided it is a minimum of 8' wide and 56' long. If only a strip is available, the Meet Director must indicate this in the pre-meet information.
- C. If carpeting is used, ¼" (3.2 cm) pile is maximum height recommended.
- D. Rebound or spring type floors are required for all JO Levels 8-10 competitions. It is strongly recommended that a spring type floor also be used at Level 7 and below.

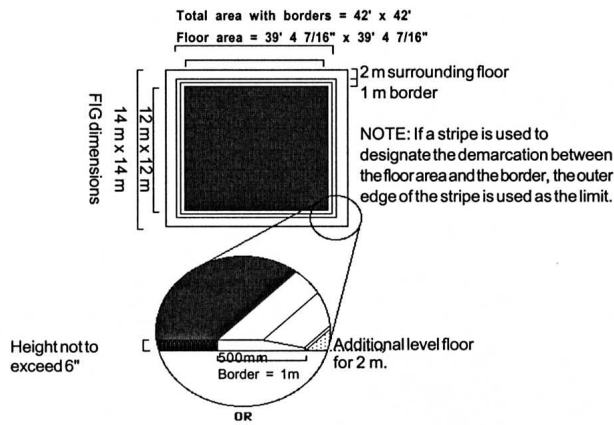

- E. Additional matting:
  - 1. Whenever additional matting is placed on the Floor Exercise area and covers any portion of the boundary line(s), the mat must be clearly marked. It is recommended that athletic tape (provided by the coach) be used to mark the mats. Chalk may be used but should be removed before the next competitor. A towel should be provided by the meet director to facilitate the removal of the chalk markings.
  - 2. Junior Olympic - all levels: Up to two manufactured mats (maximum thickness of 20 cm (8")) may be placed separately on the Floor Exercise area. If the skill cushion is 20 cm (8") in thickness, it must be a minimum of 5' x 10'. A "sting" mat may also be used on top of or under the 20 cm (8") mat.
    - a. Only one skill cushion or 10 cm (4") throw mat per tumbling pass may be used, with no more than two mats on the floor exercise area at any one point in time. A sting mat may be placed on top of or under the skill cushion/throw mat(s).
    - b. Whenever additional matting is placed on the Floor Exercise area and covers any portion of the boundary line(s), the mat must be clearly marked with tape or chalk to indicate the actual boundary line(s).
- F. When a tumbling "strip" is used in place of a full floor exercise area in the training and/or warm-up gym, it must be constructed of the same materials as the spring floor used in the competition gym and must be a minimum of 8' wide and 56' long for Junior Olympic and Elite. A minimum of 3' in length of additional padding (carpet bonded foam or something similar), is required at each end of a 56' tumble strip that is used for warm-up.

# Chapter 9 - Junior Olympic General Meet Information

## I. Information Packets

- A. Include the following information and notify all eligible teams by mail or e-mail. Information should also be posted on the host club's website.

1. Name of meet, level(s) of competition and date.
2. Host Club and Meet Directors contact information.
3. Entry fee (individual and/or team) and to whom it is payable.
4. Spectator admission fees.

Spectator fees for Level 9 East/West and JO Nationals:

	Training Day	Competition Days
Adults	Max - \$10/day	Max - \$25/day

5. Site - address, phone and map.
6. Equipment description: Meet Directors must list manufacturer(s) for all available equipment, including boards. Complete uneven bar measurements (including the full manufacturer's allowances for height and spread) must be stated in pre-meet information and on bid forms for sectional and above meets.
7. Type of awards and number to be awarded. Also include the approximate day/time of the award ceremonies, for example, "Awards immediately follow the competition".
8. Local hotel and transportation information, if necessary.
9. Competition schedule
  - a. If the number of competitors is a known quantity, then specify the schedule.
  - b. If the number of competitors and age divisions is unknown, indicate that a schedule will be sent after all entries have been received. Meet Directors of invitationals are advised to accept only a pre-determined number of athletes to avoid the necessity of conducting competitions during the weekdays.
  - c. Consideration should be given to avoid conflicts with major religious holidays or school when scheduling competitions.
10. Compulsory Levels 1 - 5 and Xcel competitions - Pre-Meet information must specify if one-judge panels will be used.
11. Pre-Meet information for Invitational meets must indicate the "type" of invitational and regulations regarding team competition.

## II. Entry Regulations and Fees

- A. All gymnastics performers and demonstrators for entertainment/demonstration purposes must be currently registered as a USA Gymnastics Athlete/Introductory Athlete Member and must be covered under the individual club's insurance policy.
- If any non-gymnastics performers (individual or group) will be participating, the host club is advised to obtain proof of insurance for that individual/group.
- B. All-Around competition is required for qualification to Sectional and above meets at all levels. Exceptions:
1. For Levels 6-10, individual event specialist competition may be conducted up to and including regional meets, at the discretion of the respective state and regional administrative committees. Individual event specialist competitors may compete and be ranked amongst the all-around competitors; may be counted in the team score; and would receive duplicate awards in the case of a tie for event placement (ties involving Individual Event Specialists are NOT broken).
  2. Athletes who are limited in the number of events in which they can perform due to a permanent physical handicap (verified by a physician) may petition to qualify to higher level meets by achieving an average score equal to the average of the All-Around qualifying score. If the qualification is by number or percentage, such individuals could be added as additional athletes provided they achieve an average score that meets or exceeds the average score achieved by the lowest qualifier.
- C. Any athlete who has qualified to a State, Regional, East/West or National Championships will be allowed to participate, provided that they are capable of performing at least one event. In this case, they must present and touch each apparatus in order to receive a score of "zero" at the events in which they are unable to compete. The scores received by this individual may also contribute to the team score.
- D. Non-citizens living and training in the United States, who are not current or past National Team members for a foreign country, may participate in all USA Gymnastics sanctioned Junior Olympic events. For Information regarding Foreign Athlete (Elite or non-elite) participation in the Junior Olympic Program, please refer to Chapter 2, page 26.

## Chapter 9

- E. In any USA Gymnastics sanctioned competition, each team/club must have at least one (1) active coach on the floor. Every coach on the floor at a sanctioned USA Gymnastics Women's competition MUST be a USA Gymnastics Women's Professional or Junior Professional Member. Junior Professional members must be accompanied by a Professional Member in order to be on the field of play (competition area) as a coach.
- F. Entry Fees and Deadlines
  - 1. It is recommended that competition entries are received, AND a competition schedule published at least 4-6 weeks prior to the first day of competition. Entries should include:
    - a. Competitors name(s), USA Gymnastics Athlete Member number, birth date, citizenship and age division.
    - b. The name(s) and USA Gymnastics Professional number, Safety Certification expiration, Background Check expiration, U110 certification and U100 certification of all participating coaches.
    - c. ALL FEES PAID IN FULL.
    - d. An athlete is considered registered/entered in a competition only when her name is listed on the club's entry form and the Meet Director has received valid payment.
  - 2. Meet Directors may not refuse entries from competitors who wish to enter a competition that serves as a Sectional Meet or any competition that serves as a qualifier to State Championships and above if all registration procedures and entry fees are PAID IN FULL.
    - Exception: If the competition fills to maximum participant capacity, the Meet Director may consider accepting additional entries if/when space becomes available.
  - 3. Cancellation Policy - The Meet Director should make the best effort to refund all or part of the entry fee in the event that severe weather or a shortage of judges would cause a cancellation of a competition.

## Meet Formats, Number of Competitors, and Warm-up Times

### I. Meet Formats and Number of Athletes

- A. Types of Competition Formats

The only acceptable meet formats are listed in this publication. Any ideas for new formats should be submitted to the National JO Committee Chairman for consideration and/or approval and possible inclusion in future *Rules and Policies*.
- 1. Traditional Formats:
  - a. Meets in which the open stretch, timed warm-ups and competition are conducted in one gym, with the timed warm-ups on all four events first, then competition on all four events (30-second TOUCH WARM-UPS are required under certain conditions- see Competition Warm-up Procedures).
  - b. Meets in which the open stretch and timed warm-ups on all four events are conducted in a warm-up gym, then the gymnasts move to a competition gym in order to compete on all four events. (30-second TOUCH WARM-UPS are always required when the timed warm-ups are conducted on apparatus other than the competition apparatus.)
    - The apparatus must be identical to the competitive gym, with the exception of the Floor Exercise. If a spring tumbling strip is used instead of a full Floor Exercise area, it must be a minimum of 60' long and 8' wide.
  - c. When using either of the above formats, if squads consist of 13 or more Compulsory gymnasts or 9 or more Optional gymnasts, the squad MAY be divided into two sub-groups for the competition warm-ups (30-second touch.) The first half takes their 30-second TOUCH WARM-UPS, and then competes; then the second half takes their 30-second TOUCH WARM-UPS and competes. TOUCH WARM-UPS on Beam and Floor may be staggered.
    - Taking the 30-second TOUCH WARM-UP in this instance is at the discretion of the personal coach and MUST be allowed, if desired.
- 2. Modified Traditional FORMAT (alternating warm-up and competition):

Meets in which the open stretch, timed warm-ups and competition are conducted in one gym in which there is only one set of apparatus. The timed warm-ups immediately precede competition on each event (this format eliminates the requirement of a 30-second TOUCH WARM-UP).

  - When squads consist of 13 or more Compulsory gymnasts or 9 or more Optional gymnasts, the squad MAY be divided into two sub-groups. The first half takes their timed warm-ups, and then competes; then the second half takes their timed warm-ups and competes. TOUCH WARM-UPS on beam and floor may be staggered.
  - Modified Traditional FORMAT #2 (alternating warm-up and competition): Meets in which the open stretch, timed warm-ups and competition are conducted in one gym in which there is one Vault, one set of bars, two balance beams, and one floor exercise mat in the competition gym. No warm-up gym. Timed warm-ups immediately precede competition on each event with continuous rotations. The judges move from the "A" beam to the "B" beam for competition.) Timed warm-ups immediately precede competition on that event. The timed warm-ups immediately precede competition on each event (this format eliminates the requirement of a 30-second TOUCH WARM-UP).
  - When squads consist of 13 or more Compulsory gymnasts or 9 or more Optional gymnasts, the squad MAY be divided into two sub-groups. The first half takes their timed warm-ups, and then competes; then the second half takes their timed warm-ups and competes. TOUCH WARM-UPS on beam and floor may be staggered.
- 3. Non-Traditional Formats:

## Chapter 9

- a. Meets that have two sets of apparatus (one for competition and a duplicate set for warm-ups) either in the same or in separate gyms and that alternate the warm-ups and competition, one event at a time. (Capitol Cup type format)
  - 1) Timed warm-ups on the first event for the first four squads (Flight 1) are conducted on the warm-up apparatus, then Flight 1 goes to the competitive equipment to compete on their first event while the next four squads (Flight 2) warm-up their first event. The two flights continue to alternate between warm-ups and competition until all eight squads have completed all four events.
  - 2) 30-second TOUCH WARM-UPS are required since timed warm-ups are not conducted on the competition apparatus.
- b. Meets which have two sets of apparatus in one gym and in which the first four squads (Flight 1) have timed warm-ups and competition on one set of apparatus, while the second four squads (Flight 2) have timed warm-ups and competition on the other set of apparatus. (Modified Capitol Cup)
  - 1) As soon as the squads in Flight 1 finish timed warm-ups on their first event and begin competition, the four squads in Flight 2 begin their timed warm-ups on their first event. Once Flight 1 completes competition on the first event, the judges move to the other set of apparatus to judge Flight 2. The two flights continue to alternate between warm-up and competition until all eight squads have completed all four events.
  - 2) Since the timed warm-ups are conducted on the competition apparatus immediately preceding the competition on the event, 30-second TOUCH WARM-UPS are not required.
- c. For both of these non-traditional formats, the total number of athletes assigned to the corresponding Flight A and B squads cannot exceed 16 for Levels 8-10, 20 for combined Levels 6 and 7 only, and 24 for Levels 1-5. If there are 9 or more (Levels 8-10), 11 or more (Levels 6-7 combined only), or 13 or more (Levels 1-5) in one of the squads, they are not allowed to split timed warm-up within their squad. It is also recommended that there be no less than five gymnasts per squad.
  - If the number of athletes in any one session is less than 40, the athletes may be divided into six or seven squads, leaving one or two events (either warm-up gym or competition gym) per rotation empty.
- d. If a separate gym is used as a warm-up gym, the apparatus must be identical to the competitive gym, with the exception of the Floor Exercise. If a spring tumbling strip is used instead of a full Floor Exercise area, it must be a minimum of 60' long and 8' wide.
- e. When at all possible, the Meet Director at USA Gymnastics sanctioned invitationals should assign teams that are split into two squads in the same flight and on "opposing" events. For example, if Team A is in two squads, Team A is assigned on Vault and Beam or Bars and Floor in the same flight, NOT Vault and Bars or Beam and Floor.
- f. It is acceptable to have a combination of non-traditional and modified non-traditional formats in the same session.
  - 1) Example: Use a warm-up gym and competition gym for UB, BB, and FX but have 2 VT stations in the competition gym.

### 4. Continuous competition format ("Gymfest format")

- a. A version of the "Modified Capital Cup" meet format mentioned above, except this new format allows sessions to overlap start and end times. It was created to maximize the number of athletes who can compete in one day in a one gym setup with two sets of equipment, with a smaller separate general warm-up space. Warm-up times and maximum number of competitors for this format should mimic the "Modified Capital Cup" meet format in the below reference chart. For additional information, please see link on [usagym.org](http://usagym.org).

## B. Determining Meet Format and Schedule

1. Select the type of format based upon number of athletes, number of levels, number of gymnasiums and amount of apparatus available.
  - Compulsory meets with 73-96 gymnasts in a session, Level 6 and 7 only meets with 57-80 gymnasts in a session, and Optional meets with 57 – 64 gymnasts in a session must use some type of non-traditional format in order to remain within the 5-hour maximum time in the gym.
2. Gymnasts shall be grouped in sessions (and/or squads) first according to Level.
3. There is no specific maximum number of judgments PER DAY per panel of judges. The limit to the total number of competitors per day is determined by the number of gymnasts allowed per session based upon which type of format is used, along with the following time restraints. The schedule of the competition must provide for the following:
  - a. The 15-30 minute general warm-up may not begin before 8:00 A.M. (General stretch and bar settings).
  - b. Must conform to the maximum number of judgments per SESSION per panel of judges (see chart).
  - c. The competition must be scheduled to end by 10:00 PM. If the meet continues past 10:00 PM due to extenuating circumstances, the meet director must submit an explanation in writing to the RTCC, with a copy to the SACC (or RACC for Regional meets), as well as to USA Gymnastics Member Services.
    - The Meet Referee must make a note of the time infraction on the Sanction Report Form.
  - d. Gymnasts should be on the floor (includes warm-ups and competition) no longer than five (5) hours when performing a single set of compulsory or optional exercises in one (1) session.
    - 1) Considering the ages of the athletes in Levels 1-3, it is recommended that the session be no longer than 2½ hours in length, including warm-up time.

## Chapter 9

- 2) If an athlete competes in two different sessions in one day, she must be provided adequate rest time between sessions.
- e. For meets with multiple sessions PER DAY, judges are to be provided up to two 30-minute break times for meals, regardless of the number of sessions per day. Additional breaks, of any duration, may be provided between sessions throughout the day. The maximum amount of unpaid break time is 60 minutes.
- 4. REQUESTS TO EXCEED THE ALLOWABLE NUMBER OF JUDGMENTS PER SESSION WILL NOT BE CONSIDERED.
  - a. If the event is a state qualifying event, additional sessions and/or days must be added.
  - b. In the case of an invitational, the Meet Director must either place clubs on a wait list or they must change their format to allow for more than four panels of judges or more than one gym.
- 5. Allow adequate time for awards ceremonies (depending on the number of age divisions, number of awards to be given, and if a separate awards area is available) between sessions when calculating total time for competition to ensure that no gymnast will compete after 10:00 P.M.

### C. Scheduling Guidelines

#### 1. **COMPULSORY COMPETITION – Levels 1 and 2 – Example with 60 competitors**

Traditional Format with a Timed Warm-up: Approximate Total Time=			2 hrs. 10 min.
Open Stretch and Bar Settings	15- 30 min.	=	30 min.
Timed Warm-up	30 seconds per gymnast	=	30 min.
Line up, march-in	10 min.	=	10 min.
Competition	1 min. per gymnast	=	60 min.

#### **COMPULSORY COMPETITION – Levels 1 and 2 – Example with 60 competitors**

Traditional Format without a Timed Warm-up: Approx. Total Time =			1 hr. 40 min.
Open Stretch and Bar Settings	15- 30 min.	=	30 min.
Line up, march-in	10 min.	=	10 min.
Competition	1 min. per gymnast	=	60 min.

#### 2. **COMPULSORY COMPETITION – Level 3 – Example with 60 competitors**

Traditional Format with a Timed Warm-up: Approximate Total Time=			2 hrs. 55 min.
Open Stretch and Bar Settings	15- 30 min.	=	30 min.
Timed Warm-up	45 seconds per gymnast	=	45 min.
Line up, march-in	10 min.	=	10 min.
Competition	1½ min. per gymnast	=	90 min.

#### 2. **COMPULSORY COMPETITION – Levels 4 and 5 - Example with 72 competitors**

Traditional Format			Approximate Total Time =	4 hrs. 52 min.
Open Stretch and Bar Settings	30 min.	=	30 min.	
Timed Warm-up	1 minute per gymnast	=	72 min.	
Line up, march-in	10 min.	=	10 min.	
TOUCH WARM-UP (when required)	30 seconds per gymnast (Maximum of 2 vaults per gymnast)	=	36 min.	
Competition	2 min. per gymnast	=	144 min.	

#### 3. **OPTIONAL COMPETITION – Levels 6 – 10 – Example with 56 competitors**

Traditional Format			Approximate Total Time =	4 hrs. 52 min.
Open Stretch and Bar Settings	30 min.	=	30 min.	
Timed Warm-up	1½ minute per gymnast	=	84 min.	
Line up, march-in	10 min	=	10 min.	
TOUCH WARM-UP (Maximum of 3 vaults per gymnast)	30 seconds per gymnast	=	28 min.	
Competition	2.5 min. per gymnast	=	140 min	



## Chapter 9

**REFERENCE CHART: TYPES OF FORMATS, WARM-UP TIMES AND MAXIMUM NUMBER OF COMPETITORS**

Type of Format	Description	Warm-up time Compulsory	Warm-up time Optional	JO Only Maximum # of competitors per session per panel of judges	Combined JO/Xcel Maximum # of competitors per session per panel of judges
<b>Traditional Format</b>	Either one competition gym <b>OR</b> a warm-up and a competition gym.  Warm-up all 4 events in the warm-up gym or in the competition gym; then compete all 4 events.	Levels 1-2: Maximum of 30 sec. timed warm-up Level 3: 45 sec. timed warm-up Levels 4 and 5: 1 minute timed warm-up  30-second touch if warm-up is in separate gym or if more than 15/squad	Level 6 and 7: 1½ minutes with a 30-second touch  Levels 8-10: 2 minutes warm-up (L9,10 – 2.5 min. Bars ONLY, includes bar settings) with a 30-second touch	Compulsory only: 72 Optional only L8,9,10: 56 Optional with only L6 and/or L7: 64 Combined Compulsory and Level 8-10 Optional in same session: Maximum of 64 athletes – no more than 28 optional	A combination of B,S, or G and JO Levels 1-5: 72 A combination of B,S, or G and JO Levels 6-10: 64 A combination of P or D and JO Levels 1-5: 64 A combination of P or D and JO Levels 6-10: 64
<b>Modified Traditional Format #1 and Modified Traditional #2</b>	Modified Traditional #1 – One set of equipment in the competition gym. No warm-up gym. (Modified Traditional #2 – One Vault, one set of bars, two balance beams, and one floor exercise mat in the competition gym. No warm-up gym. Timed warm-ups immediately preceding competition on each event with continuous rotations. The judges move from the “A” beam to the “B” beam for competition.) Timed warm-ups immediately preceding competition on that event.	Levels 1-2: Maximum of 30 sec. timed warm-up Level 3: 45 sec. timed warm-up Levels 4 and 5: 1 minute timed warm-up  No 30-second touch.	Level 6 and 7: 1½ minutes  Levels 8-10: 2 minutes warm-up (L9,10 – 2.5 min. Bars ONLY, includes bar settings)  No 30-second touch.	Compulsory only: 72 Optional only L8,9,10: 56 Optional with only L6 and/or L7: 64 Combined Compulsory and Level 8-10 Optional in same session: Maximum of 64 athletes – no more than 28 optional	A combination of B,S, or G and JO Levels 1-5: 72 A combination of B,S, or G and JO Levels 6-10: 64 A combination of P or D and JO Levels 1-5: 64 A combination of P or D and JO Levels 6-10: 64
<b>Non-Traditional (Capitol Cup) Format</b>	2 gyms (warm-up and competition)  Timed warm-up on each event immediately preceding competition on that event.	Levels 1-2: Maximum of 30 sec. timed warm-up Level 3: 45 sec. timed warm-up  Levels 4 and 5: 1 minute timed warm-up  Plus 30-second touch on the competitive equipment.	Level 6 and 7: 1½ minutes  Levels 8-10: 2-minute warm-up (L9,10 – 2.5 min. Bars ONLY, includes bar settings)  30-second touch on the competitive equipment.	Compulsory only: 96 Optional only L8,9,10: 64 Level 6 and/or 7 only sessions may have up to 80 Combined Compulsory and Level 8-10 Optional in same session: Maximum of 80 athletes no more than 32 Optional L8-10 Combined Compulsory and Level 6-7 Optional in same session: Maximum of 80 – any # of opt. or comp. level athletes is allowed. See page 108, I.A.3.c for squad size guidelines.	A combination of B,S, or G and JO Levels 1-5: 96 A combination of B,S, or G and JO Levels 6-10: 80 A combination of P or D and JO Levels 1-5: 80 A combination of P or D and JO Levels 6-10: 64
<b>Modified Non-Traditional (Modified Capitol Cup) Format</b>	2 sets of equipment in the competition gym (No warm-up gym).  Flight 1 squads compete on one set; Flight 2 competes on other set. Timed warm-ups immediately precede competition on each event.	Levels 1-2: Maximum of 30 sec. timed warm-up Level 3: 45 sec. timed warm-up  Levels 4 and 5: 1 minute timed warm-up  No 30-second touch	Level 6 and 7: 1½ minutes  Levels 8-10: 2 minute warm-up (L9,10 – 2.5 min. Bars ONLY, includes bar settings)  No 30-second touch	Compulsory only: 96 Optional only L8,9,10: 64 Level 6 and/or 7 only sessions may have up to 80. Combined Compulsory and Level 8-10 Optional in same session: Maximum of 80 athletes no more than 32 Optional L8-10 Combined Compulsory and Level 6-7 Optional in same session: Maximum of 80 – any # of opt. or comp. level athletes is allowed. See page 108, I.A.3.c for squad size guidelines.	A combination of B,S, or G and JO Levels 1-5: 96 A combination of B,S, or G and JO Levels 6-10: 80 A combination of P or D and JO Levels 1-5: 80 A combination of P or D and JO Levels 6-7: 80 A combination of P or D and JO Levels 8-10: 64

\* If a squad has more than one level competing, the timed warm-up will be determined by the combined total number of minutes allowed for each level.

## Chapter 9

- D. COMPETITIVE FORMAT AND DRAW: Procedures after entries have been received.
1. The State Administrative Committee may decide the competitive format and draw procedures for PRE-SECTIONAL AND SECTIONAL MEETS ONLY to allow the draw for sessions to be determined by either age divisions or by teams.
    - If the draw is conducted by teams, awards are given for all levels and/or age divisions competing in each session.
  2. The draw for sessions at State and above Championship competitions is to be determined by age divisions.
    - a. The State Administrative Committee determines specific guidelines that determine the order of competition for the age divisions and/or levels (for example, by random draw or youngest to oldest) for State meets.
    - b. Using the pre-determined State guidelines, the Meet Director and State Administrative Committee Chairman, (or other State Administrative Committee Members designated by the SACC), conduct the draw to determine the order in which the age divisions will be conducted.
    - c. In all sanctioned USA Gymnastics State and Regional Championships, Individual Event Specialists (IES) shall be placed first on the event she is competing using the following steps:
      - 1) Organize gymnasts into squads.
      - 2) Draw for starting events and flights.
      - 3) Place the IES first on the event she is competing within the squad.
      - 4) No one gymnast shall compete as the first performer of the competition in more than one event, unless there are scratches that reduce the total number of competitors in the squad to less than four (4) athletes.
    - d. The format and number of athletes for State and Regional competitions must be approved by the RJOCC and RTCC.
      - 1) For State/Regional Championships: the maximum number of gymnasts per session may be exceeded by a small percentage for special circumstances, with the approval of the RTCC, RJOCC and the RACC for State Meets and by the NTCC and the NJOCC for Regional Meets.
      - 2) It is the Meet Director's responsibility to contact the appropriate officers (State Meet Directors contact the SACC; Regional Meet Director contact RTCC). The State or Regional officer(s) will then contact the appropriate individuals, as stated above, for final approval.
  3. Club team competition format and draw shall be determined by the:
    - a. Meet Director for invitationals and local meets.
    - b. State Administrative Committee for the Pre-sectional qualifiers, Sectional and State meets.
    - c. Regional Administrative Committee for Regional competitions.
  4. Alphabetize teams and assign competitive numbers for each gymnast, designated by age divisions and/or Levels. Each level and/or age division should be designated by a specific number sequence, if possible.
    - a. If only achievement awards are given for Level 5 or below, the gymnasts are not required to compete within designated age divisions.
    - b. To assign competitor numbers, first determine all athletes in the same age division, listed alphabetically, first by team, then by last name.
  5. Determine the number of gymnasts per session based on type of competition, and allowable number of gymnasts per squad. The number of gymnasts per squad is determined by dividing the total number of gymnasts in the session by four in a traditional format, by five if a "bye" rotation is used, or by 8 in a non-traditional (Capitol Cup) format. (See Competition Formats)
  6. Draw for team placement into necessary number of squads. All members of the same age division and/or level from the same team will be drawn for competitive order in the same squad in the same session.
    - a. Priority - keep levels and/or age divisions in the same session and, if possible, the same squad(s).
    - b. If warm-ups are conducted in a separate gym or on a separate set of apparatus in the same gym alternating with competition (non-traditional format), all athletes on the same team MUST be drawn in the same squad(s) within the same flight (in the same gym).
    - c. No team (club) should be drawn into more than two squads in any one session, unless the total number of gymnasts from that club exceeds the number of gymnasts that would be drawn into two squads.
      - If there are several age divisions and/or levels within the same session, teams may be drawn for placement in one or two squads.
    - d. The Meet Director should always consider the safety of the athlete first to determine the best format for the competition.
  7. Draw for starting events for each squad.
  8. Order of Events
    - a. FIG Olympic competitive order is Vault, Uneven Bars, Balance Beam, and Floor Exercise.
    - b. In the case of only one squad or 4 squads (1 panel or 4 panels of judges), the squad(s) will rotate in Olympic order.
    - c. If only 2 events compete simultaneously (2 panels of judges), it is recommended that Vault and Bars run first, followed by Beam and Floor Exercise.
  9. Draw for competitive order by taking the numbers of all gymnasts assigned to that squad and draw randomly. No one gymnast shall compete as the first performer of the competition in more than one event, unless there are scratches that reduce the total number of competitors in the squad to less than four (4) athletes.

## Chapter 9

- a. If more than one level must be drawn in one squad, all athletes of the same level must compete consecutively. When rotating to the next event, the first competitor of a level would be dropped to the last spot.
  - b. In the case of team invitationals in which the order of competition is drawn by team and the coach decides the competitive order of the gymnasts, all teams in the squad would compete gymnasts of one level, then repeat the team order with the next level of gymnasts.
10. To determine the competitive order when rotating to the next event, the number of places to be “dropped” must be applied uniformly per session and is based on  $\frac{1}{4}$  of the number of competitors in the largest squad in that session.  
**EXAMPLE:** Two even squads of 12 and two squads of 11- drop the first three (3) gymnasts in each squad to the end of the competitive order when rotating to the next event. Four odd-number squads of 9 - drop the first two (2) gymnasts to the end of competitive order.

6 or less gymnasts in a squad – drop one (1) spot

Gymnast 1 – V  
 Gymnast 2 – UB  
 Gymnast 3 – BB  
 Gymnast 4 – FX

12+ gymnasts in a squad – drop three (3) spots

Gymnast 1 – V  
 Gymnast 2  
 Gymnast 3  
 Gymnast 4 – UB  
 Gymnast 5  
 Gymnast 6  
 Gymnast 7 - BB  
 Gymnast 8  
 Gymnast 9  
 Gymnast 10 – FX  
 Gymnast 11  
 Gymnast 12

7-11 gymnasts in a squad – drop two (2) spots

Gymnast 1 – V  
 Gymnast 2  
 Gymnast 3 – UB  
 Gymnast 4  
 Gymnast 5 – BB  
 Gymnast 6  
 Gymnast 7 - FX

- In the case of a squad being reduced in numbers due to gymnasts scratching prior to the start of competition, it may be necessary to re-define the start order on each event for that squad only if the original number of dropped places is more than  $\frac{1}{4}$  of the number of gymnasts in that squad.
11. The order of competition (start lists) must be distributed to all coaches and judges and posted at the competition site.

## II. Meet Warm-Ups

A. Pre-meet (timed) warm-ups

1. A 15-30 minute general/open warm-up time is required. The Uneven Bars are available to obtain settings only (Tap Swings). The apparatus is NOT available for warm-up during the general warm-up time. Marking mount distances or practicing run-up onto the board is allowed. The Floor Exercise mat and other matted and open areas may be used for locomotor warm-up activities, such as running, and for skill warm-up that can be performed in a confined space. Line drills on Floor involving simple elements are allowed; however, tumbling on the diagonal is not allowed.
2. Timed warm-ups
  - a. Rotations are determined by the following formula:
    - 1) Compulsories: Levels 1-2: Maximum of 30-seconds X number of gymnasts per squad  
 Level 3: 45 seconds X number of gymnasts per squad  
 Levels 4-5: 1 minute X number of gymnasts per squad
    - 2) Optionals: **Level 6-7: 1½ min.** x number of gymnasts per squad (regardless of format)  
**Levels 8 / 9 / 10: 2 min.** x number of gymnasts per squad (regardless of format)
      - i. For Levels 9 / 10, 2.5 minutes x number of gymnasts per squad on UNEVEN BARS ONLY, INCLUDES BAR SETTINGS (regardless of format).
    - 3) The amount of time for Vault and Floor Exercise pre-meet warm-ups is determined by the number of athletes in the largest squad of the session multiplied by the allotted time per gymnast (see charts below).
    - 4) If a squad has more than one level competing, the timed warm-up will be determined by the combined total number of minutes allowed for each level (see charts below).

Example 1:

Squad	# gymnasts	Level	Warm-up Time
A	10	All Level 6/7	15 min (10 x 1.5)
B	10	All Level 6/7	15 min (10 x 1.5)
C	10	All Level 6/7	15 min (10 x 1.5)
D	10	8 at Level 6/7; 2 at Level 8	16 min (8 x 1.5 plus 2 x 2 min)

In Example 1, all squads would have 20 minutes (time of the largest squad) for vault and floor.

## Chapter 9

Example 2:

Squad	# gymnasts	Level	Warm-up Time
A	8	All Level 6	12 min (8 x 1.5)
B	8	All Level 7	12 min (8 x 1.5)
C	10	All Level 6	15 min (10 x 1.5)
D	8	6 at Level 7; 2 at Level 8	13 min (6 x 1.5 plus 2 x 2 min)

In Example 2, all squads would have 20 minutes (time of the largest squad) for vault and floor.

- b. All Levels (1-10) Bar settings (adjustments) are NOT included in the warm-up time, unless an athlete chooses to block time, either within their own team or with other teams.
- 1) The clock will not stop within the block time.
  - 2) Each block is allowed to set the Bars ONE INITIAL TIME before the warm-up time begins.
  - 3) The clock WILL STOP between EACH block.
  - 4) Separate blocks of ANY SIZE can occur within a squad.
  - 5) At all sanctioned events, only one gymnast at a time can be on the bars for any part of the warm-up period (this would include timed warm-ups and 30-second touch.)
- c. Block time will be allowed on Bars and Beam only at the discretion of each individual coach for teams that have several gymnasts in one squad. Individual gymnasts from different teams may join together to block time, if they so desire.
- 1) When using a “warm-up/compete” format (one gym and one set of apparatus) with timed warm-ups immediately preceding competition on each event, gymnasts may "block" time.
  - 2) At USA Gymnastics sanctioned competitions that use a draw for individual competitive order, the first athlete to compete MUST warm-up first, whether she chooses to block or to take individual warm-up time. If the first athlete blocks warm-up time with additional athletes in the squad, those athletes will warm-up with the first competing athlete.
  - 3) Staggered timed warm-up is NOT allowed on Balance Beam.
  - 4) Coaches with more than one gymnast from the same team are allowed to block all of their gymnasts together on balance beam; however, this is NOT required. Individual time per gymnast is allowed with the time stopping between gymnasts. Coaches are strongly encouraged to assist each other with any adjustment of equipment, if needed.
- d. Block time for timed warm-ups is not allowed on Vault or Floor Exercise.  
 Note: The entire squad warms up at the same time for Vault and Floor. The amount of time is calculated by multiplying the allowable warm-up time per athlete by the number of athletes in the largest squad in that session.
- e. Vault Warm-Up Procedures: The time will begin when the gymnast stands on the table to do a skill/jump off the table. If the gymnast does not do a skill/jump off the table, the time will begin when the gymnast begins running toward the table and touches the spring board. Warm-up drills i.e. “Handstand hops” and a “run by” without touching the board is NOT included in the warm-up time and will be allowed as long as performing these drills does not delay the competition. Excessive delay of “warm-up drills” when the timer is ready could result in a deduction.
- f. Floor Exercise Warm-up Procedures for meet formats that provide only one floor exercise mat for competition (or one floor and a tumbling strip):
- 1) With squad of 8 or fewer Optional gymnasts: warm-up all 8 gymnasts (1½ min. each for traditional; 2 min. for non-traditional formats), then compete.
  - 2) For non-traditional formats, the total number of athletes assigned to the corresponding Flight A and B squads cannot exceed 16 for Levels 8-10, 20 for combined Levels 6 and 7 only, and 24 for Levels 1-5. If there are 9 or more (Levels 8-10), 11 or more (Levels 6-7 combined only), or 13 or more (Levels 1-5) in one of the squads, they are not allowed to split timed warm-up within their squad.
  - 3) With any allowable size squad: warm-up athletes between competitive routines.
    - a) When using this option, the Meet Director **MUST** assign an adult monitor to regulate the number of athletes warming up at any one point in time and to keep track of the competitive order. It is not a responsibility of the judges.
    - b) A gymnast is allowed to start warming up when there are only six more competitors ahead of her. This gives each athlete 5 turns on the Floor mat prior to her time to compete and there will be no more than five athletes warming up on the floor at any one point in time.
    - c) Example with 8 gymnasts per squad: When the first squad in Flight A warms up on Floor, the first six athletes will warm-up together (6 x 2 minutes=12 min.). Once competition begins, the 7<sup>th</sup> athlete will warm-up while judges evaluate #1 gymnast; after each subsequent routine, another athlete will be added to warm-up.
    - d) This procedure may also be used for the TOUCH WARM-UP.

## Chapter 9

- e) For Compulsory Levels 1-5, in a modified non-traditional format, athletes may warm-up between floor routines as a group, corresponding with the squad numbers above (f.2). The group is not limited to six athletes, as required by Levels 6-10. If the coach feels not enough warm-up time has been given, he/she may ask the Chief Judge for a reasonable amount of additional time.
  - f) If a coach determines that the athletes have not had adequate warm-up time in between routines, he/she can request of the Chief Judge to either have a short block of time for a squad or partial squad to warm-up, or for the judges to slow down to allow for up to 30 seconds between exercises, especially for Levels 4 and below.
  - g. If an athlete (or team) disregards the timer and exceeds the warm-up time, the timer must report the infraction to the Meet Director or Meet Referee. This would be considered as the warning and any subsequent infraction would result in a 0.20 penalty.
  - h. Warm-up rotation order
    - 1) Traditional format: Squads start the timed warm-ups on their second competitive event and rotate in Olympic order to finish warm-ups on their first competitive event.  
EXAMPLE: Warm-up order: UB, BB, FX, V  
Competitive order: V, UB, BB, FX
    - 2) When "Bye Squads" are used, timed warm-ups must be in the same order as the competitive rotation.
  - i. If timed warm-ups are conducted in a separate Warm-up gym, all equipment (warm-up and competition) must be identical (with the exception of Floor Exercise, where a tumbling strip made with the same type springs, foam and carpet as the FX mat may be used in the warm-up gym). Each board must be marked for a specific gym and event.
  - j. If a gymnast arrives late to a competition due to circumstances beyond her control (traffic delay, weather-related), every effort should be made to allow the athlete to compete. She should be provided a safe and effective warm-up without upsetting the flow of the ongoing event. Provided that she has arrived for her designated session/age division, her scores will be valid for all individual and team rankings.
- B. Competition (30-second touch) warm-ups
- 1. The TOUCH WARM-UPS are conducted as follows:
    - a. Vault: TOUCH WARM-UPS are not controlled by time, but rather by a guaranteed maximum number of vaults per gymnast.
      - 1) Level 1-5 competitions: each gymnast is guaranteed a maximum of two (2) TOUCH WARM-UP vaults.
      - 2) Level 6-10 Competitions: each gymnast is guaranteed a maximum of three (3) TOUCH WARM-UP vaults.
      - 3) Each gymnast is allowed to stand on the vault table and jump (or salto) off ONE TIME ONLY, in addition to their specific number of allowable vaults.
      - 4) After presenting to the judges, the gymnasts are allowed ONE "runback" from the board before the vault attempts are counted.
    - b. Bars: A 30-second warm-up per gymnast is allowed; setting of the bars is NOT included in the "touch" warm-up time.
    - c. Beam: 30-seconds per gymnast.
      - TOUCH WARM-UPS on beam only may be staggered.  
Example: For competitions using the Modified Traditional format, the first three gymnasts warm-up on beam, then athlete #1 competes. Then the 4th gymnast warm-ups while the judges evaluate the score for the first gymnast. After each subsequent routine, the next gymnast in rotation order will warm up.
    - d. Floor Exercise: All gymnasts in the squad (or half the squad in the case of large squads) warm up simultaneously for a time period determined by multiplying the number of gymnasts by 30 seconds. Example: 5 gymnasts will be given 2½ minutes as a group to warm-up.
      - Note: The Meet Director may choose to use the option of conducting the warm-ups in between the competitors.
  - 2. A TOUCH WARM-UP on the competitive equipment prior to each event is required for:
    - a. Any competitions that do not conduct timed warm-ups on the competitive equipment.  
Note: Any meets (Compulsory or Optional) that are conducted with timed warm-ups directly preceding competition on each event are NOT REQUIRED to have TOUCH WARM-UPS.
    - b. State and above competitions, regardless of the number of gymnasts per squad. Exception: Compulsory level meets are not required to have 30-second TOUCH WARM-UPS if squads do not have more than ten (10) gymnasts.
    - c. Compulsory Level 4 and 5 competition with sixteen (16) or more gymnasts per squad.
      - Levels 1-3 are not required to have TOUCH WARM-UPS.
    - d. All optional competitions (regardless of the number of gymnasts per squad).
  - 3. For Traditional format meets: In the case of large squads (9 or more Optional; 13 or more Compulsory), the squad MAY be divided into two (2) groups. The first half takes a TOUCH WARM-UP and then competes; then the second half takes a TOUCH WARM-UP and competes.

## Chapter 9

- The option to alternate competition with the TOUCH WARM-UPS (staggered touch) may also be used, at the discretion of the Meet Director.
- 4. The TOUCH WARM-UPS are not required to be in competitive order.
  - a. The first athlete to compete must be given the opportunity to touch first.
  - b. Athletes will be allowed to take the TOUCH WARM-UP in any order to expedite the one-TOUCH WARM-UP, but each athlete must still be individually timed 30-seconds on Bars and Beam.
  - c. On vault, the athletes may warm-up in any order, but each athlete is still guaranteed a maximum of 2 vaults (Level 1-7) or 3 vaults (Level 8-10).
  - d. If the one-TOUCH WARM-UP on Beam is staggered with warm-ups between competitive routines, the one TOUCH WARM-UP must be in competitive order.
- 5. A gymnast is not required to take the TOUCH WARM-UP.
- 6. In the case of an unavoidable delay in the competition (i.e. electrical power outage, serious injury, etc.), the Chief Judge (and/or Meet Referee and Meet Director) may allow an additional TOUCH WARM-UP for those athletes who have already taken the 30-second touch but have had to wait an unreasonable amount of time. The safety of the athletes must be the primary concern.

### III. Specific Competition Procedures

Included below are rules from the *JO Code of Points* for Athletes, Coaches, Judges, Meet Personnel and Spectators.

- A. There shall be no more than 20 minutes between the end of timed warm-ups and the start of competition (or the 30-second touch competition warm-up).
- B. Gymnasts should march from event to event, with the squad presenting itself to the Chief Judge. Exception: Competition formats that include continuous rotation do not require a formal march or presentation to the judges.
- C. ONLY competing gymnasts and their coach(es) are allowed onto the competition area, and ONLY during the session in which they are competing.
  - 1. The only additional people allowed on the competition floor are those directly involved with the running of the event (e.g., trainers, scorers, flashers, runners, etc.).
  - 2. Coaches should make child care arrangements for their offspring, unless the child is old enough to act in a volunteer capacity at the competition.
- D. At Level 9 East/West and Level 10 National Championships, the gymnast MUST wear her competitive number during the competition, unless she is performing a back spin on beam or floor, in which case the coach must show the number to the judges. At JO Nationals, high school aged athletes are encouraged to wear their competitive number during the training day as well, in order to assist collegiate coaches in identifying the athletes.
  - 1. If the gymnast refuses to wear the number, a warning would be issued to the coach of the gymnast. If she fails to wear the number at subsequent events, a deduction for inappropriate attire would be applied.
  - 2. At all other meets at which competitor number bibs are provided, the numbers may be worn or displayed.
- E. At the State, Regional, East/West and National optional competitions, the gymnast must flash the vault number of the vault that she intends to perform.
- F. If a gymnast is injured prior to or during the competition, but is unable to compete in all four events, she must touch the apparatus of the event(s) in which she is unable to compete. By receiving a score of zero or higher, she has the right to continue in the competition.
  - 1. If the gymnast does not present to the Chief Judge and touch the apparatus on the next event(s), she will be considered as withdrawing (scratching) from the meet and thus forfeits her right to continue but is eligible for awards on the events she competed.
  - 2. If a gymnast is injured during the competition and is unable to compete in any additional events, she is not required to "touch" the apparatus on the remaining events. She is, however, still eligible to receive awards on any events completed prior to withdrawing (scratching).
- G. Scoring
  - 1. Base score will be established at the judges' meeting at Sectional and above competitions with the use of the Technical Committee DVD; therefore, no analysis of forerunners is necessary, and all events commence at the same time.
  - 2. It is recommended that each judge must either independently input their score electronically or submit the score in writing on a separate score slip. If only one keypad is available per event, both judges must write their own score and both (or all four) scores should be entered electronically to ensure an accurate average score. At all sanctioned meets, there MUST be a written back-up (in the form of a verification heat sheet) to record the individual judges' scores, neutral deductions and the final average score. In order to ensure accurate results, both vaults scores should be entered into electronic scoring system, especially at qualifying and championship competitions.
  - 3. Open scoring is defined as either electronically flashing each judge's score or by writing each judge's score on each athlete's competitor card. Open Scoring is:
    - a. Required at Junior Olympic Nationals and Level 9 Eastern/Western Championships.
    - b. Allowed at Regional meets (determined by the Regional Administrative Committee).

## Chapter 9

- c. Allowed at Optional State Meets (determined by State Administrative Committee).
  - d. Allowed at Optional Invitationals, at the discretion of the Meet Director.
  - e. Not allowed at any compulsory meet, including compulsory State Championships.
  - f. Procedures for Open Scoring
    - 1) Each judge should independently determine his/her score.
    - 2) Each judge should record the Start Value and final score on the judging slip and send it to the Chief Judge via the runner. If using electronic entry, only the score is entered.
    - 3) After the Chief Judge receives all judges' scores, each individual judge's score is then flashed on the score-flashing unit.
    - 4) If the score is changed as a result of a conference, the adjusted score should be re-flashed as a "Corrected Score".
  - g. Refer to the Meet Organizational Guidelines – Clerical Committee for additional procedures for use of Open Scoring. These guidelines can be found on the USA Gymnastics website at:  
<http://usagym.org/PDFs/Women/Rules/Rules%20and%20Policies/w-meetorgguide.pdf>.
4. Start Values for Optional (Levels 6 - 10) Competitions
    - a. Start Values are required to be either flashed or written on the competitor's card at ALL Level 6, 7, 8, 9 and 10 competitions.
    - b. The State Administrative Committee may determine if the communication of Start Values is required (or allowed) at Xcel meets.
    - c. Procedures for Flashing Start Values:
      - 1) Each judge should independently determine a Start Value.
      - 2) The Start Value and the final score should be recorded on the judging slip and sent via the runner to the Chief Judge.
      - 3) Each judge should flash the Start Value on the Start Value flashing unit as soon as the Chief Judge receives ALL judges' scores.
      - 4) Start Values do not have to match. A conference MAY be called to determine if the Start Value needs to be adjusted, either up or down.
      - 5) If the Start Value is changed as a result of a conference, the adjusted Start Value should be re-flashed.
      - 6) See Meet Organizational Guidelines, Clerical Committee for additional procedures for the flashing of Start Values. These guidelines can be found on the USA Gymnastics website at  
<http://usagym.org/PDFs/Women/Rules/Rules%20and%20Policies/w-meetorgguide.pdf>.
  5. Judges may score in 0.05 increments at all USA Gymnastics sanctioned competitions.
  6. A final score of 1.00 will be awarded for any Compulsory or Optional Bars, Beam or Floor Exercise routine that would result in a score equal to or less than one point (1.00).
    - At State Meet and above, all void (optional) vaults should be unofficially scored, but not submitted, unless a video review is decisive in determining the vault was complete.
  7. Once the final average score is submitted to the scoring system, it may not be changed unless an inquiry is submitted and results in a score change.
    - a. A Chief Judge may change a score after submission to the scoring system IF a neutral deduction (such as out of bounds or overtime) was inadvertently not applied. This change must occur prior to the end of the rotation. The coach must be notified of the score change and if possible, the new score should be displayed to the public.
    - b. If a judge realizes that a gymnast was mistakenly judged using the incorrect rules for her level, the routine may be re-evaluated using the appropriate rules to determine the correct Start Value and specific compositional deductions, based on the judges' shorthand. This re-evaluation must occur within 5 minutes of the end of the competition for that session. The judging panel must notify the Meet Referee and the scoring personnel that the re-evaluation is to occur. The coach must be notified immediately of any score change.
    - c. If there is a clerical error when entering scores electronically, the score may be officially changed by the end of the session.
    - d. Recommendation that, for State Championships and above: In extenuating situations, the Meet Referee has the authority to allow a judging panel to review a routine to verify that Special Requirements were fulfilled. The coach must be notified that a review will occur. No additional deductions are allowed to be taken by a judge after the review if the special requirement(s) in question is (are) awarded.
  8. All-Around Score (AA)
    - a. Compulsory All-Around is the total score for the four compulsory events.
    - b. Optional All-Around is the total score for the four optional events.
  9. Individual Event Finals Score: The format and qualification procedures for the Finals competition are determined by the Meet Director and must be published in advance.
    - a. Finals may be conducted at Invitational meets.
    - b. There are no Individual Event Finals conducted in any USA Gymnastics Junior Olympic Program Championship competition.

## Chapter 9

- c. The Individual Event score/rankings are determined during the optional All-Around competition.
10. Team Score
- a. The method used to calculate the team score must be described clearly in the meet information for invitational meets.
  - b. For USA Gymnastics Junior Olympic Pre-Sectional Qualifiers, Sectionals and State club/team competitions, the State Administrative Committee shall determine the method used for determining team score. Some options are:
    - 1) Limit the number of gymnasts on a team and count all scores. (Example: 6-member team, or 3-member team, all scores count.)
    - 2) Specify the number of gymnasts on a team and count all scores but one on each event. (Example: 6-member team, 5 scores per event count.)
    - 3) Allow an unlimited number of gymnasts per team; specify number of scores per event to count.
- H. Inquiry Regulations
1. Coaches are entitled to see all scores of their individual gymnasts. Inquiries may be based only on the following:
    - a. Compulsories - Incorrect elements, evaluation of major elements, falls, neutral deductions or unusual occurrences.
    - b. Optionals - Awarding of Start Value, specific "flat" compositional deductions, falls, neutral deductions or unusual occurrences.
      - A flash from a camera is not a valid reason to allow a gymnast to repeat a routine.
  2. The Meet Director must provide inquiry forms at a place designated at the coaches meeting. The form is available:
    - a. on the USA Gymnastics website under Women's Program at:  
<http://usagym.org/pages/home/pages/forms.html?prog=w#womens>
    - b. from your State Administrative Committee Chairman
  3. Inquiries must be submitted to the Meet Director or Meet Referee within 5 minutes of the completion of the squad's competition on that event.
    - a. No fee may be charged to submit an inquiry.
    - b. Coaches need to be aware that an inquiry allows for a second evaluation, which may result in:
      - 1) no change in score,
      - 2) the score being raised, or
      - 3) the score being lowered.
    - c. Exception to the 5-minute to submit inquiry rule:
      - 1) If, after the completion of the last event, an athlete's AA score is a maximum of 0.10 less than the qualifying score to the State (or Regional) Championships, the coach may submit an inquiry for the gymnast's lowest scoring event in order that the athlete be considered for qualification purposes. Any change of score is official and is included in the final results.
      - 2) If an athlete begins her fourth event, is injured during the routine and unable to complete her fourth event, she may petition to Regionals if her score from her first three (3) events is equal to or greater than 75% of the required petition score.  
Example: Regional Qualifying Score = 34.00. Required petition score = 35.00. The athlete must achieve a three-event score totaling 26.25.  
Example: Regional Qualifying Score = 35.00. Required petition score = 36.00. The athlete must achieve a three-event score totaling 27.00.
      - 3) These processes listed in sections 1) and 2) above DO NOT APPLY:
        - a) for mobility purposes, OR
        - b) if qualification to the state or regional meet is by percentage or designated number per age group.
  4. After the Chief Judge has completed the response to the inquiry, the Meet Referee or Meet Director will return the form to the coach. The coach may not approach the judge regarding the inquiry during the competition.
  5. No video review is allowed at any Junior Olympic competition during the processing of an inquiry unless the following criteria are met:
    - a. At State Meets and above, a coach can request video review by the Meet Referee and the highest rated unaffiliated judge (if video is available) in the event that the inquiry involves possibility that the judges missed an element that would affect the Start Value. The video review process may NOT be used to appeal a judgment of degree assessment, i.e. degree of casts, handstands, incomplete turns, direct connection of elements, or leg separation in leaps as well as other like skills.
      - 1) If the Meet Referee or highest rated judge is affiliated with the athlete in question, the video review will be conducted by the two highest rated unaffiliated judges, or the highest rated unaffiliated judge and a USA Gymnastics officer.
      - 2) The Meet Referee must inform the judging panel that a video review will be initiated as well as the final decision.  
Examples:
        - a) All judges did not record a full turn on BB.
        - b) One or more judges recorded a 2/1 twist instead of 3/1 twist on FX.



## Chapter 9

- c) To verify if the gymnast grasps or touches the bar with one or two hands before falling on a release element.
  - d) To verify if the gymnast lands on the bottom of the feet first on Vault, Uneven Bar/Balance Beam dismounts, Beam Acro elements that finish on top of the beam (foot/feet), and Floor Exercise Saltos.
  - b. At State Meets and above, video review will be allowed to consider spotting deductions.
  - c. At State Meets and above, video review will be allowed to consider floor line violations.
6. If administrative procedures (see below) were not properly followed on a submitted inquiry, the coach may petition the Jury of Appeals for a review within 5 minutes of the end of the rotation/competition or the return of the inquiry form whichever occurs later. At State Championships and above, a video review, if available, may be considered by the Jury of Appeals. All video must be reviewed in regular-time. Slow-motion WILL NOT be considered. Jury decision should occur within 15 minutes after the conclusion of meet and before the awards are presented.
- Procedures for Inquiries:
- a. Properly written inquiry form by the coach.
  - b. Inquiry submitted in a timely manner to the Meet Referee or Meet Director.
  - c. Inquiry reviewed/answered by the judging panel of the event in question.
  - d. Inquiry returned to Meet Referee or Meet Director.
  - e. Meet Referee or Meet Director returns inquiry to coach by hand or by a pre-defined inquiry return procedure.
- I. Jury of Appeals
- 1. The Jury of Appeals is needed to resolve problems in certain situations (see the *Junior Olympic Code of Points*). The Jury of Appeals for local and state meets is comprised of the following individuals:
    - a. Meet Director (non-voting, if question relates to his/her gymnast)
    - b. Meet Referee (President of the Jury)
    - c. Chief Judge of the Event in question
    - d. If available, one USA Gymnastics representative (Elected State or higher Committee member or any Regional or National Officer)
  - 2. Methods of settling a case by the Jury:
    - a. Discussion
    - b. Voting on a decision
    - c. Majority vote dictates the final decision
  - 3. Jury of Appeals for Regional and above competitions shall include the Meet Director (unless affiliated with the inquiry), the Meet Referee, and the USA elected Administrative Officers.
- J. Justification for changing a score as a result of a conference, inquiry or Jury of Appeals:
- 1. If an error (mathematical, recording, or flashing) exists.
  - 2. If the average score was computed from scores that were out of range.
  - 3. If time and/or line violations were administered improperly.
  - 4. If the Jury of Appeals decides to penalize the gymnast for improper attire or behavior, or the coach for improper behavior.
  - 5. If the video review panel determines that an incorrect evaluation has been made.
- K. Audience/Spectator Regulations
- 1. Spectators are not allowed to enter the "field of play" competitive area. They must use only the area designated for the public.
  - 2. Spectators are not allowed to use flash photography during the pre-meet warm-ups or competition, as this may endanger the performing athletes.
  - 3. Drones are not permitted during the pre-meet warm-ups or competition, as this may endanger the performing athletes.
  - 4. Spectators shall not disturb the order of the meet, its competitors and its officials. Individuals causing violations shall be asked to leave the competition site.
  - 5. The spectators shall not carry food or drinks into the spectators' area, if so directed.
  - 6. Children (offspring) of coaches and/or judges should not be on the competition floor unless performing a specific duty, such as "runner" or "score flasher".
- L. Participant Regulations
- The use of cell phones for verbal conversation is PROHIBITED while on the field of play (competition area). Coaches are permitted to record their own gymnasts' exercise for personal use but should not in any way interfere with the competition. Exception: Walkie-talkies for the Meet Director and host club personnel and medical personnel are allowed.
- M. Music Regulations
- 1. Music failures/errors that occur before the athlete has started the routine can be corrected and the correct music restarted.
  - 2. Procedures for music failure during the routine due to technical failure:
    - a. The gymnast may continue her routine. Upon completion of the routine, gymnast and coach must decide whether to repeat the routine or accept the score that is given. The judges will post no score until that decision is made. No deduction would be taken for the absence of music.

## Chapter 9

- b. The gymnast may stop her performance immediately and request permission from the Chief Judge to repeat her routine or to continue from the point of interruption. Once permission is given, the gymnast would perform again (either from the point of interruption or the entire exercise) after a reasonable amount of rest time. No score would be given for the partial routine.
3. There are no grounds for a coach or gymnast to request to repeat a compulsory exercise routine if the wrong version of the same level floor music plays. (i.e., coach/music personnel inadvertently plays Flute version instead of Piano version.)
4. Floor music must be downloaded onto a mobile device for competitions to avoid interruptions/failure to play/errors. Accessing music via cellular or internet connections at competitions is not allowed.

### N. Invitationals

All USA Gymnastics-sanctioned Invitationals are governed by the *USA Gymnastics Rules and Policies*, USA Gymnastics safety guidelines and judging criteria. They may be held at the local, state, regional, national and international club level.

#### 1. TYPES OF INVITATIONALS

- a. Individual or team Invitationals (Compulsory or Optional) which specify certain Level(s). Because all rules pertaining to that Level are followed, scores at such invitationals may be used to qualify to Sectionals, may be used in injury petitions and may be used for mobility purposes.
- b. Individual or Team OPEN OPTIONAL Invitationals are competitions involving more than one level of gymnast, all being judged under one set of rules (for example, Elites, Level 10 and possibly Level 9's competing under Level 10 rules). Level 9 and 10 gymnasts ONLY may use the scores achieved at Open Optional Invitationals to qualify (up to State), for petition purposes, and/or for mobility.
- c. Any Invitational involving athletes from foreign countries or USA "Elite" National Team members must contact the USA Gymnastics Member Services for USA Gymnastics and/or FIG procedures.

#### 2. Rules and Procedures for Invitationals

The following deviations from USA Gymnastics Local, Sectional, and State Qualifying procedures will be allowed at any invitational:

- a. The Meet Director must publish the following in the pre-meet information:
  - 1) The age divisions and schedule for awards for each division.
  - 2) Spectator admission fees and gymnast's entry fees.
- b. Teams may determine the competitive order of their gymnasts for each event.
- c. Teams may be comprised of gymnasts from different age divisions and/or different Levels.
- d. When using a meet format that requires a TOUCH WARM-UP, each team may block time for TOUCH WARM-UP, based on 30 seconds per gymnast for bars, beam and floor exercise. If athletes choose to block time on bars, the clock will not stop for the setting of the bars. Vault TOUCH WARM-UP is based on a specific number of vaults (2 for up to Level 7 and 3 for Levels 8-10.)
- e. For all sanctioned events that have multiple sessions of the same level vying for the same individual awards and team awards, athletes must be judged by the same judging panels. This does not apply to overall team awards with combined levels of competition.
- f. Non-citizens and foreign athletes are eligible for awards at all Invitationals. It is not required to give duplicate awards for non-citizens/foreign athletes. A non-citizen training as a member of a U.S. club may also be included in a Club's Team Score. For Information regarding Foreign Athlete (Elite or non-elite) participation in the Junior Olympic Program, please refer to Chapter 2, page 26.
- g. Open scoring and flashing of Start Values are allowed at Optional Invitationals, at the discretion of the Meet Director, provided that the guidelines found on page 108 are followed.
- h. If All-Star teams (teams comprised of athletes from different clubs/teams) are allowed to compete for team score, the meet director must indicate this in the pre-meet information.
- i. Team Competition at Invitational Meets:

The Meet Director may determine the format and draw for Club team competition.

  - 1) A draw will be made to determine which teams will start on each event. If there is more than one team per squad, the teams will draw for order of competition within the squad.
  - 2) Each team may determine the competitive order of its gymnasts.
  - 3) The team may be comprised of gymnasts from different age divisions and/or different levels, depending upon the type of invitational.
    - In the case of team invitationals in which different levels are competing within the same squad and receiving separate awards, all teams in the squad would compete gymnasts of one level, then repeat the team order with the next level of gymnasts.
  - 4) If All-Star teams (comprised of athletes from different clubs) are allowed to compete for team score, this must be indicated in pre-meet information.
- j. Individual Event Finals Competition (at Invitationals)
  - 1) The Meet Director, Technical Director and/or Meet Referee conduct a random draw.
  - 2) If running one event at a time, competition proceeds in Olympic order.

## Chapter 9

- 3) If two events run simultaneously, it is recommended to conduct Vault and Bars competition first, followed by Beam and Floor Exercise.
  - 4) If two events run simultaneously, and a gymnast is drawn for the same or similar competitive order in both events, she will be dropped down in the rotation for her second event in order to provide adequate warm-up and recovery time.
3. Gymnasts going out of order –  
Clarification: There is no deduction for athletes competing out of order. At invitational meets that use a competitive start list, the coach may change the order if it would facilitate the use of equipment on the same setting. The Meet Director and the coaches within the squad must approve this. Please refer to *Rules and Policies*, page 112, N.2.b. and N.2.i.1). and 2).
- O. Sanction Violations – see Chapter 3, page 28-29.

## Awards

The minimum numbers and/or types of awards that must be distributed are listed below. A meet director may present more awards, but not less, than those listed. Non-citizens living and training in the United States, who are not current or past members of a foreign national team, may participate in all USA Gymnastics sanctioned Junior Olympic events and are eligible for awards. At Junior Olympic Nationals (Level 10), if a non-citizen places in the top four (4) AA, she will receive the award for her AA placement; however, she is not eligible to become a member of the US Junior Olympic National Team. In this instance, the next US citizen in rank order will be placed on the JO National Team. For Information regarding Foreign Athlete (Elite or non-elite) participation in the Junior Olympic Program, please refer to Chapter 2, page 26.

### I. Individual Awards

- A. Levels 1, 2, 3, 4
1. The State Administrative Committee determines whether achievement awards only, placement awards only, or a combination of both, are given.
    - a. If Achievement awards are given, the State Administrative Committee will determine the guidelines for scores.
    - b. If Placement awards only are given, Level 4 will follow the guidelines for Level 5 and above.
- B. Levels 5, 6, 7, 8, 9, and 10
1. If only one gymnast is entered in an age division, she receives the 1st place All-Around medal only.
  2. If 2-10 gymnasts are entered in an age division:
    - a. Award 1<sup>st</sup> and 2<sup>nd</sup> All-Around for 2 gymnasts
    - b. Award 1-3 All-Around for 3-5 gymnasts
    - c. Award 1-4 All-Around for 6-10 gymnasts
    - d. Award 1st place in each event
  3. If 11-20 gymnasts are entered in an age division:
    - a. Award 1-6 All-Around places
    - b. Award 1-3 event places
  4. If 21-50 gymnasts are entered in an age division:
    - a. Award 1-6 All-Around places
    - b. Award 1-6 event places
  5. If 51 or more gymnasts are entered in an age division:
    - a. Award 1-10 All-Around places
    - b. Award 1-10 event places
- C. Competition with Individual Event Specialists included
- Whenever Individual Event Specialists are included in a competition, the Individual Event Specialists compete and are ranked amongst the All-Around competitors. However, if there is a tie between an Individual Event Specialist and an All-Around athlete, the tie is NOT broken. Both athletes would receive identical awards.
- Example for the vault event:
1. First place athlete's score is 9.40.
  2. Next highest score is 9.30, earned by two athletes - one competing in the AA and the other competing as an Individual Event Specialist. This tie is not broken; both gymnasts receive the 2<sup>nd</sup> place award.
  3. The next highest scoring athlete earns a 9.20 and would then receive the 4<sup>th</sup> place award.
- D. If the draw for sessions is by club teams, awards for all age divisions must be presented at each session.
- E. A State Administrative Committee Chairman may request that the Regional Administrative Committee Chairman grant a deviation from these minimum recommendations based on financial conditions of the State Meet. The Regional Administrative Committee may choose to deviate from these minimum recommendations based on financial conditions of the Regional meet.
- F. If a gymnast competes in the wrong age division, her scores are invalid for the meet (may not be used for All-Around, Individual Events or Team awards); however, the score achieved may be used for level mobility.

## Chapter 9

- G. Duplicate awards will be given in the case of a tie at the Level 9 Eastern/Western Championships and Level 10 Junior Olympic National Championships.

### II. Team Awards

- A. Team awards are to be determined by the State Administrative Committee.
- B. Club team competition at Regional, East/West and National competitions is not allowed
- C. State and/or Regional Team competition
- Level 8 and 9 Regional Championships: State Team awards may be presented (at the discretion of the Regional Administrative Committee).
  - Level 9 Eastern/Western Championships:
    - Regional team awards are presented to all members of the top regional team.
    - An overall Regional Team Champion will be determined based upon the rankings of the Regional Teams in each age division. Points will accumulate based upon the following team placement per age division:

1 <sup>st</sup> place team	4 pts.
2 <sup>nd</sup> place team	3 pts.
3 <sup>rd</sup> place team	2 pts.
4 <sup>th</sup> place team	1 pt.
  - Junior Olympic National Championships (Level 10):
    - Regional Team Awards are presented to all members of the top three teams in all eight age divisions.
    - An overall Regional Team Champion will be determined based upon the rankings of the Regional Teams in each age division. Points will accumulate based upon the following team placement per age division:

1st place team	8 points	5th place	4 points
2nd place	7 points	6th place	3 points
3rd place	6 points	7th place	2 points
4th place	5 points	8th place	1 point
    - The top four gymnasts per age division will receive a Junior Olympic National Team plaque.

### III. Award Tie Breaking System

THIS SYSTEM IS TO BE USED WHEN AWARDING TROPHIES OR ENGRAVED MEDALS. It may also be used when awarding ribbons; however, if financial conditions permit, it is strongly recommended that duplicate awards be presented.

- A. Recognition of tied gymnasts
- If there is a tie for first place, BOTH GYMNASTS are champions and should be announced as such, although one will receive the second place award if duplicate awards are not possible.
  - In the case of ties for other places, the gymnasts will be announced as being tied for that rank; however, the tie-breaking procedure determines which gymnast receives the higher award, if duplicate awards are not given.
  - All gymnasts who tie for a place receive an award. When there is a tie for the last place awarded, the tie-breaking procedure is used to determine which gymnast will receive the award that day. Duplicate awards should be sent, within one month, to the remaining tied gymnasts.
- B. Distribution of Awards: Example of tie for first place:
- Award the first place medal by one of the tie breaking procedures.
  - The second place medal is then presented to the tied gymnast.
  - There is NO second place ranking.
  - The third place medal is then presented to the next gymnast, and so on.
- C. Tie-Breaking Procedures for Presentation of Awards
- For meets that cannot provide duplicate awards for placement, the tie-breaking system should be used. However, whenever there is a tie, the computer should be programmed to skip the next place (example, Tie for 1<sup>st</sup> - both gymnasts are recognized as 1<sup>st</sup> place winners, with one gymnast receiving the gold, the other silver based on the tie-breaking procedure. The next highest scoring gymnast receives the 3<sup>rd</sup> place award and no 2<sup>nd</sup> place award is presented.)
- Ties in the All-Around (Compulsory or Optional)
    - The gymnast with the highest individual event score receives the award for the tied place.
    - If the gymnasts are still tied, then the gymnast with the second highest individual event score receives the award.
    - If the gymnasts are still tied, then the gymnast with the third highest individual event score receives the award.
    - If the gymnasts are still tied, then the flip of a coin in the presence of both coaches will break the tie for the award.
    - At Level 9 Eastern/Western Championships, Level 10 National Championships, Elite Challenge, and Classic competitions, athletes tied in the All-Around will receive duplicate awards. However, for the purpose of presenting awards, use the above criteria, if necessary. The gymnast receiving the lower place award will be sent a duplicate award, if not available at the competition.
    - At Level 10 National Championships, if there is a tie for fourth place All-Around, both (all) tied athletes will qualify to the Junior Olympic National Team.

## Chapter 9

2. Ties in the Individual Events - Compulsory Only or Optional Only
  - a. The gymnast with the highest All-Around total receives the award for the tied place.
  - b. If the gymnasts are still tied, then the flip of a coin in the presence of both coaches will break the tie for the award.
  - c. At Level 9 Eastern/Western Championships, Level 10 National Championships, Elite Challenge, and Classic competitions, athletes tied in an individual event will receive duplicate awards. However, for the purpose of presenting awards, use the above criteria, if necessary. The gymnast receiving the lower place award will be sent a duplicate award, if not available at the competition.
3. Ties at Individual Event Finals (New Life) at Invitationals
  - a. The gymnast with the highest preliminary score on that event receives the award for the tied place.
  - b. If still tied, then the gymnast with the highest All-Around score from the preliminary competition receives the award for the tied place.
  - c. It is recommended that tied gymnasts receive duplicate awards. Use the above tie-breaking criteria if duplicate awards are not given for financial purposes or if duplicate awards are not available at the competition. The gymnast receiving the lower place award should be sent a duplicate award, if not available at the competition.
4. Ties in Team Score - Compulsory Only or Optional Only
  - a. The team with the highest team score on a single event receives the award for the tied place.
  - b. If still tied, the team with the next highest team score on an event receives the award for the tied place.
  - c. If still tied, continue to the next highest of the events.
  - d. If there is a tie for Regional team score at Level 10 Nationals or at Level 9 East/West, both teams will receive duplicate awards. However, for the purposes of presenting awards, use the above criteria. All gymnasts on the team receiving the lower place award will be sent a duplicate award.
  - e. In case of a tie for last awarded place, both teams are to receive awards. Use the tie breaking procedures to determine which team receives the award that day and send a duplicate award to the members of the other team.
    - In the case of a tie for the overall Regional Team Champion award, both regions will be announced as co-champions.

## SELECTION OF COMPETITION HOSTS FOR QUALIFYING EVENTS

### I. Bidding for a USA Gymnastics Competition

Bid forms for National meets, can be found on the USA Gymnastics website under Women's Program Forms. State and Regional Bid Forms are available through the State and Regional Administrative Committee Chairman.

- A. Junior Olympic Pre-Sectional Qualifiers, Sectional and State level competitions: send a completed bid form to the State Administrative Committee Chairman.
- B. Junior Olympic Regional competitions: send a completed bid form to the Regional Administrative Committee Chairman.
- C. Level 9 Eastern/Western Championships and Junior Olympic (Level 10) National Championships: send a completed Intent to Bid form to the Junior Olympic Program Director.

### II. Criteria for Selection of Competition Hosts

After all the bids are received, they are ranked, and the host named. The aim is to provide equal opportunity to all applicants and to grant the event to the optimal host organization. Several factors are considered.

- A. The host organization must have successful event organizational experience and the reputation of operating according to the highest of ethical standards.
- B. The geographic location of the meet is to be rotated from time to time.
- C. The total schedule and location of national meets for that year.
- D. The Meet Director MUST be a Professional Member with current Safety Certification and criminal background check, from a member club or registered business, and also must be certified as a Meet Director.
- E. The host organization and the meet director must guarantee the best organizational set-up for a quality event, according to the *USA Gymnastics Rules and Policies*.
- F. The Junior Olympic National Championships (Level 10), as well as Level 9 Eastern and Western Championships, facility must be available for one day of training prior to the event.
- G. The host organization must be responsible for any financial loss it may incur.

## Chapter 10 - Elite Program

The Elite Program is designed to provide competitive experiences for athletes aspiring to the National Team. The National Teams (Senior and Junior) are selected from the USA Championships each year. Additional athletes will be added from the training camps as needed to represent the USA. These athletes represent the United States in international competitions.

The Talent Opportunity Program (TOPs) is under the direction of the International Elite Committee. This program provides early screening and identification of talented athletes. The TOPs program offers State and National testing along with camp opportunities and educational materials for its participants.

HOPES and TOPs program athletes are NOT classified as "Elite" athletes.

Coaches' Representatives to the International Elite Committee (IEC) are elected by their peers following the National Championships. National Team activities and developing a strong training program for the aspiring athletes and coaches is the main responsibility of the committee.

The Elite Program is administered through the national office. The USA Gymnastics Women's Managing Director of Athlete and Coaching Programs appoints a TOPs State Manager(s) for the development and growth of the Talent Opportunity Program within each state. Each state's TOPs Manager(s) should work closely with the State Administrative Committee Chairman and State Administrative Committee to promote the program.

For those clubs entering the Elite/HOPES Program for the first time, it is advised that they visit the website for the most current and accurate information: <http://www.usagym.org/pages/women/pages/index.html>

### Elite Athlete Participation – Domestic Qualifying Events

Only athletes eligible to represent the United States in World Championships and the Olympic Games are permitted to compete in Qualifying or Selection events for the World Champion or U.S. Olympic Team. Athletes must be declared eligible based on USA Gymnastics and FIG regulations prior to any Qualifying events. Specifically, athletes who have represented another country in international competition, regardless of citizenship (Foreign Athletes), who are ineligible to represent the United States at World Championships or the Olympic Games may not compete in Qualifying or Selection events for the team.

Qualifying events include Selection event(s) for World Championships or the Olympic Games, as well as preceding events that serve as the qualification pathway. Qualification events are detailed more specifically in section 1.2.2 of the athlete selection procedures for World Championships and the Olympic Games in each discipline.

Exceptions *may* be granted for Foreign Athletes to participate in Pre-Qualifying events, provided ALL of the following stipulations are met:

- A) Must be a current USA Gymnastics athlete member.
- B) Event registration is open; i.e., not restricted to current national team members or other defined group of participants, and/or does not have a set number of participants.
- C) Participation does not displace a spot that would otherwise have been allocated to a U.S. athlete.
- D) The event does not serve as a ranking/re-ranking event for the national team and is not a selection event for international assignments.
- E) Participation is approved in writing by the appropriate Program Vice President/Director prior to the close of the meet's entry deadline.
- F) If granted, the participating athlete is not eligible to qualify to the next level of Qualification/Selection event pursuant to "B-D" above.

### Types of Elite Competitions and Opportunities

#### I. COMPETITIONS

National Qualifying Competitions are open to all USA Gymnastics Athletes who have the desire, dedication, and interest in pursuing the Elite Program. It is strongly recommended that any coach and athlete interested in competing at the Elite level participate in the TOPs and elite developmental programs. Please call the National office with any questions concerning foreign athlete participation.

## Chapter 10

- A. Compulsory and National Qualifiers are qualifying meets (by score) for the Classic competitions. National Qualifier Meets are both compulsory and optional competitions.
1. All information regarding Elite meets, including results, will be posted on the website. Elite Qualifying meet information must be available on the website at least four (4) weeks in advance of the competition date. The meet hosts are responsible for reporting the results by e-mail no more than 24 hours after the competition to the USA Gymnastics Women's Senior Vice President at the National Office.
  2. Interested gyms may conduct compulsory qualifying meets by request only. Request should be sent to USA Gymnastics Women's Vice President at the National Office. The compulsory qualifier request form may be found on the USA Gymnastics web site at: <https://usagym.org/PDFs/Women/ElitePre-Elite/hostrequestform.pdf>
  3. There will be designated National Qualifiers for the purpose of qualifying athletes to the Classic competitions. Meet Directors of the National Qualifying Meets must send meet information to the USA Gymnastics office to be posted on the USA Gymnastics website and must be available on the website at least four (4) weeks in advance of the competition date.
  4. National qualifiers will be conducted prior to the Classic competitions.
  5. There is no limit to the number of compulsory or optional attempts for qualification.
- B. National Competitions
1. American and U.S. Classic Meets
    - a. An American Classic will be conducted prior to the U.S. Classic.
    - b. The U.S. Classic competition will be conducted two to three weeks prior to the USA Gymnastics Championships.
    - c. Gymnasts qualified directly to a Classic meet will be required to register and pay online by the deadline indicated.
    - d. The HOPES classic competition is an Optional only competition and is conducted for HOPES level competitors. The meet serves as the qualification to the HOPES National Championships.
    - e. The HOPES National Championships will be the top 36 (top 18, 10-11 year-olds/top 18, 12-13 year-olds) athletes from the HOPES Classic meet. The next two athletes in each age division in rank order will be used as alternates in case of injury.
    - f. American and U.S. Classics competitions are Optional competitions and are conducted for qualified Junior and Senior International Elite level competitors and serve as the qualification meets to the USA Gymnastics Championships.
  2. USA Gymnastics Championships
    - a. The USA Gymnastics Championships is Optional competition for the Junior and Senior International Elite level competitors.
    - b. The Women's Team Responsibility Manual is reviewed each year by the International Elite Committee and distributed to all athletes who make the U.S. National Team.
- C. Entry Fees
1. Compulsory only Meets: Recommended entry fee is \$75.00.
  2. National Qualifier and Classic Meets: Recommended entry fees are: Compulsory - \$75.00 and Optional - \$125.00.
  3. There is no entry fee for the USA Gymnastics Championships.
  4. Entry fees for Elite competitions are non-refundable within 30 days of the competition.
- D. Competition Rules
1. International Elite level competitions will adhere to FIG rules. Refer to the FIG website at: [www.fig-gymnastics.com](http://www.fig-gymnastics.com). For changes in competition and matting rules, see the respective competition directives.
  2. Hopes division will adhere to modified FIG rules which are posted on the website, under Women's Program – TOPs/HOPES.
  3. Elements not listed in the *FIG Code of Points* must be submitted to the Technical Director in advance of the competition.
- E. Awards
- Awards are given according to the following guidelines:
1. No awards for compulsory competitions.
  2. HOPES Level:
    - a. National Qualifiers, Classic and Championships All-Around and Individual Event rankings are determined by the Optional scores only.
    - b. National Qualifier: Medals awarded for each age division in the all-around and events: If there are 5 or less gymnasts competing, award first place. If there are 6 or more gymnasts competing, award first through third place.
    - c. National Qualifiers: At the conclusion of each session announce the athletes who have reached the classic optional qualification score.

## Chapter 10

- d. Classic and Championships competition: Six places will be awarded in each age category, unless the total number of athletes in each age division falls below 24. In that case, the number of places awarded will follow the Junior Olympic guidelines.
3. International Elite Level:
  - a. National Qualifiers: Competitors will receive All-Around medals based on the rankings from the Optional competition. If there are 5 or less gymnasts competing, award first place. If there are 6 or more gymnasts competing, award first through third place.
  - b. National Qualifiers: At the conclusion of each session announce the athletes who have reached the classic optional qualification score.
  - c. Classic competitions: All-Around and Individual Event ranking is determined by Optional scores. Eight places will be awarded in each category, unless the total number of athletes in each age division falls below 24. In that case, the number of places awarded will follow the Junior Olympic guidelines.
  - d. USA Gymnastics Championships:
    - 1) Individual Event champions are determined by combining the Optional event score from Day One and Day Two (50%-50%). Eight places will be awarded for Individual Events.
    - 2) All-Around Champions will be determined by combining the Optional AA scores from Day One and Day Two (50%-50%). Eight places will be awarded for the All-Around.

## II. Camps

Athletes competing in HOPES/Elite competitions, TOPs and Junior Olympic Nationals may be invited to attend training camps.

Coaches who have an athlete that they believe is ready for the International Elite level competition or training camp program may submit a YouTube video to the High Performance Team Coordinator and request admission to a Training Camp. If accepted, all costs associated with their attendance at camp are the responsibility of the gymnast and coach. Subsidies for these costs may be available and vary from year to year.

You must include the full name and age of the gymnast(s), gym name and coaches contact information.

YouTube video link should be sent to Tom Forster at [tforster@usagym.org](mailto:tforster@usagym.org).

The video must include the following:

- 2 best Optional Skills or sections on bars, beam and floor
- 1 Optional Vault

Coaches who have an athlete 13 years old or younger who are preparing for the elite program may request admission to the Developmental training camp program. These camps provide hands on training for both athletes and coaches to help each athlete reach their potential. If accepted, all costs associated with their attendance at camp are the responsibility of the gymnast and coach.

You must include the full name and age of the gymnast; gym name and coaches contact information.

YouTube video link should be sent to Dan Baker at [starsgymhouston@aol.com](mailto:starsgymhouston@aol.com).

The video must include the following:

- 5 Press handstands (with the same criteria as TOPs physical ability testing)
- 10 Leg Lifts (with the same criteria as TOPs physical ability testing)
- Elite Compulsory Routines commensurate to the age of the athlete
- 2 best Optional Skills on bars, beam and floor
- 1 Optional Vault



## Elite Age Determination, Mobility, And Petitions

### I. Elite Age Determination

- A. The age of an Elite or HOPES/TOPs athlete is determined as of December 31, in the year of the culminating meet for her level.
  - Age requirements for the divisions are determined each year by the respective Committees and will be published in the Elite Qualification Chart.
- B. A gymnast must provide her date of birth on the Entry Form.
- C. A HOPES level gymnast is required to designate her level when entering a National Qualifier to be allowed to use the HOPES rules.
  - Exception: Due to modifications to the FIG requirements for the HOPES division, a HOPES age athlete trying to qualify for the International division may use an International FIG Optional score to qualify to the HOPES Classic in her appropriate age division.

### II. Level Mobility

- A. For the purpose of qualification, the Elite competitive year begins with the conclusion of the USA Gymnastics Championships and ends with the beginning of the USA Gymnastics Championships the following year.
- B. Any international level gymnast who starts the first Optional event at a Classic competition is considered an Elite gymnast and may not drop back to the Junior Olympic Program in the same Elite competitive year.
- C. A gymnast who competes in the American Classic or US Classic:
  - 1. Is considered an Elite athlete.
  - 2. May not drop back to the Junior Olympic program in the same Elite competitive year.
- D. Gymnasts may attempt to qualify in any level within the Elite Program throughout the Elite competitive year.
- E. If a HOPES level gymnast qualifies to the HOPES Classic competition and then, within the same season, qualifies to the Junior International level for a Classic competition, she may enter either the HOPES Classic or the Junior International Classic level, but not both.
- F. A gymnast attempting to qualify for the Junior International division may use a FIG Optional competition score from a National Qualifier to qualify to the HOPES Classic meet in the appropriate age division.
- G. Athletes competing at the Junior International level in the national qualifiers may drop back to the HOPES level that corresponds to their age if they have not competed at the international level at a classic meet.
- H. Compulsory qualifying scores may be obtained at compulsory meets and National Qualifying meets. Optional qualifying scores may be obtained at the National Qualifiers without jeopardizing a gymnast's Junior Olympic competitive status. Once a gymnast obtains a qualifying score, it remains valid for the entire Elite/HOPES competitive year.
- I. An Elite gymnast may choose to return to the Junior Olympic Program (Level 10) the following competitive year by sending a "reason for change" letter FROM HER COACH to the National Junior Olympic Committee Chairman.
  - 1. All petitions must be received at least three weeks prior to the Level 10 State Meet.
  - 2. The National Junior Olympic Committee will review the petition and the Chairman will notify the coach of the acceptance/denial of the petition and will copy the respective State and Regional Administrative Committee Chairmen.
  - 3. Accepted petitioned athletes may not re-enter the Elite/HOPES Program during that Elite competitive year.

### III. Injury Replacements at USA Championships

- A. If qualification to USA Championships is by score, there will be NO injury replacements.
- B. If qualification to USA Championships is by placement:
  - 1. All replacements will come in rank order from the U.S. Classic competition, providing the minimum qualifying score has been obtained.
  - 2. Replacements may be made up until 24 hours prior to the start of competition.

## IV. Procedures for Petitioning

Petitioning procedures are used when the athlete is unable to compete due to illness, injury or extenuating circumstances; they are not intended to replace the qualification system. If a petition is denied, the athlete is ineligible to submit another petition for a higher-level meet.

- A. USA Championships
1. No petitions will be considered for athletes obtaining an all-around score at a Classic competition.
  2. Any athlete who has attended one or more Open, Developmental, or National Team training camps in the current year is eligible to submit a petition for consideration.
  3. All athletes who are not able to compete in the All-Around at a Classic meet due to a previous injury but are planning to petition to Championships will be required to attend the U.S. Classic and perform on a minimum of one event, unless the athlete has competed in a USA Gymnastics international competition during the current competitive year or verified at a National Team training camp within the month prior to the U.S. Classic Meet.
  4. The petition must be sent to the Vice President of Women's Program prior to the Classic competition, unless the athlete is injured during the Classic competition. The petition must include:
    - a. A written request from her coach, and/or her parent or guardian stating the reason for petition.
    - b. A photocopy of the gymnast's All-Around results from her most current Elite Meet(s).
  5. A physician's written verification of the illness or injury and the date of release for return to activity must be included with all injury petitions.
  6. The Athlete Selection Committee will make all decisions regarding petitions for Classics/Championships.
    - a. Decisions will be evaluated on an individual basis.
    - b. The submission of a petition is **not** a guarantee of acceptance.
    - c. The committee will consider the following areas when evaluating the petition:
      - 1) Results from recent international and national championships.
      - 2) D (Difficulty) and E (Execution) Scores in comparison to the current Elite qualification chart. Note that, per event, the three-event score is higher than a four-event score.
      - 3) World Class presentation.
      - 4) Readiness to compete.
      - 5) Physical capability to fulfill training plan as listed in the *Women's Responsibility Manual*.
  7. The National Office, as instructed by the Athlete Selection Committee, will notify the gymnast and her coach of the approval or denial of the petition.
  8. There will be no other avenue for admittance to Championships outside of these petitioning procedures (i.e., video or pre-meet verification).
- B. Classics Petitions:
1. All current or former Elite athletes are eligible to submit a petition to a Classic Meet.
  2. All athletes who attended a training camp or have competed in a National Qualifying competition are eligible to petition.
  3. Petitions should be sent, according to the above guidelines, to the Senior Vice President of Women's Program for review by the Athlete Selection Committee.

## Elite Qualifying Scores and Procedures

### I. Competition Requirements for Elite Divisions

- A. Score Requirements:
1. All HOPES gymnasts must achieve the compulsory and optional qualifying score each year.
  2. A HOPES gymnast wishing to advance to the International Elite level must obtain the International Compulsory qualifying score for that year.
  3. Once a gymnast has passed the Compulsory requirement and has started her first optional event at a Classic competition, she is considered an Elite athlete and her Compulsory score remains valid for the rest of her career.
  4. A Junior International Elite gymnast is considered an Elite if she has competed as a Junior International Elite in the Junior World Trials or the American or US Classic.
  5. Detailed qualification scores, rules and age group information are available on the Elite Qualification chart.  
<https://usagym.org/pages/women/pages/index.html>

## Chapter 10

- B. Qualification Meets
  - 1. HOPES
    - a. Compulsory only meets
    - b. National Qualifiers - Compulsory and Optional competition
    - c. Classic competition - Optional scores will be used to determine both the All-Around and Individual Event standings.
    - d. Qualifying Scores at the National Qualifiers will be determined by the International Elite Committee and published will be posted on the USA Gymnastics website, in the Elite Qualification Chart.
  - 2. Junior and Senior International Elite
    - a. Qualifying scores at the compulsory only meets and National Qualifiers (Compulsory and/or Optional)
      - 1) Compulsory and Optional qualifying scores will be determined by the International Elite Committee and will be posted on the USA Gymnastics website, in the Elite Qualification Chart.
      - 2) Any athlete who qualified and/or competed at the previous year's USA Championships may be automatically qualified to the next year's Classic competition. This will be determined by the International Elite Committee and published will be posted on the USA Gymnastics website, in the Elite Qualification Chart.
    - b. Qualifying scores at the Classic competition - Optional competition (AA) - Optional qualifying scores will be determined by the International Elite Committee and will be published and posted on the USA Gymnastics website, in the Elite Qualification Chart.
    - c. Qualification scores may be obtained from a National Team training camp and/or National Team selection camp. Refer to the Elite chart for those scores and updated regulations.

## II. Qualification to the Junior and Senior National Team

The National Team size can be up to 30 athletes. To address our country's needs and mirror the quad age requirements, the junior and senior team sizes will change each year. The Support Programs for the National Team Members will be included in the *National Team Handbook* and will be presented each year at the National Team Meeting after Championships.

- A. The Junior and Senior National Team will be determined at the National Championships from the competition results and open slots assigned from among qualified athletes.
  - Open slots may be held by the Athlete Selection Committee for later use, based upon the needs of the team.
- B. The Junior and Senior National Team size will be determined by the International Elite Committee each year and will be posted on the USA Gymnastics website, in the Elite Qualification Chart.
- C. If the International Elite Committee determines that additional slots on the National Team are to be added, this selection will be conducted by the Athlete Selection Committee.
- D. The Junior and Senior National Team are required to participate in National Team Training Camps throughout the year and are eligible to be selected to represent the U.S. in International competitions.
- E. Selection procedures for Pan American Games, World Championships, and Olympic Games will be decided by the International Elite Committee, posted on the USA Gymnastics website and distributed to current age-eligible National Team members.
- F. To ensure that support funds are awarded to those athletes who are representing our country at the highest-level meets:
  - 1. The Senior funding slots will be determined after the final selection of the World or Olympic Team and then the remaining slots will be awarded by the rank order at USA Championships.
  - 2. The Junior funding slots will be determined from the rank order established at USA Championships.

## Talent Opportunity Program (TOPs)

The Talent Opportunity Program is an identification system that is implemented by the Developmental Team Coordinator under the direction of the *International Elite Committee*. Its purpose is to assist the coach with early identification of potentially talented athletes, nurture and assist in the development of these athletes and their coaches, and to provide competitive opportunities.

### I. Age and Membership Requirements

- A. Gymnasts must be registered Athlete Members of USA Gymnastics between the ages of 7 and 10.
- B. Age is determined by December 31 of the year of the testing.

## II. TOP Opportunities

- A. TOPs State testing - Physical Abilities and Skill Testing
  - State TOPs testing must be conducted annually in June and/or July.
- B. TOPs National testing - Physical Abilities and Skill Testing
  - National TOPs testing will be conducted annually in September or October.
- C. National TOPs Team Training Camp is offered to:
  - 1. Qualified athletes in the 8-10 year old divisions.
  - 2. Coaches of qualified 7-year old athletes. (The 7-year old athletes do not travel to camp.)
  - 3. National TOPs Team Training Camp will be conducted annually in December.
- D. An Invitational TOPs Training Camp will be conducted in December. Those athletes who did not qualify to the TOPs National Team will be invited in rank order from the National Testing results to attend a training camp at their own expense. Additional open TOPs camps may be conducted throughout the year.

## III. Awards

- A. National Certificates and T-shirts are presented to all athletes participating at National Testing.
- B. The National TOPs A Team is provided with a training camp (all expenses paid for each athlete), and apparel. For more information about the TOPs Program and testing dates, contact your designated TOPs State Manager of the USA Gymnastics Women's Managing Director of Athlete and Coaching Programs.

The TOPs information, which includes testing forms, is available on the TOPs website.

<https://usagym.org/pages/women/pages/index.html> - click on TOPs.

## FOREIGN ATHLETE PARTICIPATION

- A. Foreign athletes without a green card may **NOT** participate in the following: TOPs National Teams; TOPs National Testing; National Elite Qualifier Competitions; Classic and National Championship competitions; Developmental and National Team training camps.
- B. Foreign athletes that retain a US green card may participate in the following:
  - 1. TOPs National Camp
  - 2. National Testing
  - 3. Developmental Camp
  - 4. National Elite Qualifier
  - 5. Classic Competitions
- C. Any foreign athlete, with or without a US green card, who has represented her home country in competition or as a member of a national team must follow the FIG rules.
- D. Effective August 1, 2016 for athletes with dual Nationality: If the athlete represents a foreign country in an international competition, the athlete may NOT participate in the US Elite Program for a minimum of two Elite competitive years. For the purpose of qualification, the Elite competitive year begins with the conclusion of the USA Championships and ends with the beginning of the USA Championships the following year.

FIG Rules Pertaining to Foreign Athlete Participation:

- 37.2.1 Gymnasts who have represented their countries internationally  
When a gymnast who has represented his/her country, moves to another country and obtains citizenship (official nationality) of the latter country, he/she may – with the consent of the two Federations concerned and the Executive Committee – immediately represent the new country. FIG Statutes 2018 update PK 37 20171110\_STATUTS\_V02 2018\_E.DOCX Where such consent is not granted, he/she may (with the consent of the Executive Committee) represent the new country one year after the date of the positive decision made by the Executive Committee.\*
- 37.2.2 Dual Nationality  
Where a gymnast or a judge has dual nationality he/she may choose which country he/she wishes to represent but, having represented that country, he/she cannot also – except as provided for in paragraph 37.2.1 above – represent the other country in question.\*

## Apparatus Requirements for Elite Competitions

### I. General considerations

- A. Athlete safety guidelines, as listed in the *USA Gymnastics Safety Handbook*, should always be considered.
- B. Elite competitions must adhere to the FIG apparatus norms. They can be found on the FIG web site at: [http://www.fig-gymnastics.com/publicdir/rules/files/en\\_Apparatus%20Norms.pdf](http://www.fig-gymnastics.com/publicdir/rules/files/en_Apparatus%20Norms.pdf)
- C. It is recommended that there be a clearance of 5' to 6' from one apparatus to any other. This includes corresponding mat area or any other obstruction, i.e., other apparatus, walls, pillars, etc.
- D. Equipment specifications, including vault runway thickness, must be published in the pre-meet information.
- E. All equipment and matting used at an elite qualification competition must be approved by the USA Gymnastics women's program.

### II. FIG Specifications

Apparatus specifications may be found on the FIG web site at [http://www.fig-gymnastics.com/publicdir/rules/files/en\\_Apparatus%20Norms.pdf](http://www.fig-gymnastics.com/publicdir/rules/files/en_Apparatus%20Norms.pdf)

### III. Additional Apparatus Specifications:

- A. COMPETITION LANDING MATS FOR VAULT, BARS AND BEAM
  - 1. ELITE/Hopes must use FIG specifications 20 cm. (-2 cm tolerance, no + tolerance) mat thickness.
    - a. National Qualifying meets must use 20 cm. mats.
    - b. International Elites and Hopes athletes MUST use a 10 cm supplemental landing mat for vault and for bars/beam dismounts at all optional competitions. This mat cannot be moved once the routine begins.
    - c. If a vaulting board is used for a mount it must be placed on top of the 20 cm and or the 20 cm and 10 cm. Competition matting cannot be moved once the routine begins.
    - d. The 10 cm dismount mat for balance beam will be designated to one end on the beam and not moved.
    - e. Only the manufactured **100 by 120 cm** Round Off Entry mats are allowed for use in front of the vaulting board for hand placement on Round off entry vaults. Sting mats are NOT allowed on the vault runway.
- B. Supplemental Matting (Skill Cushions, 4" throw mats and sting mats)
  - 1. Vault
    - All levels - no supplemental matting for optional competition. A skill cushion should be available during warm up.
  - 2. Bars
    - a. USA Championships: No additional matting other than FIG specifications may be used.
      - Junior International athletes may place a manufactured sting or 10 cm mat under the bars during competition in addition to the 20 cm base mat. This matting cannot be moved. Junior International athletes may use a skill cushion (maximum thickness of 8") in addition to the 20 cm (-2cm tolerance) competition landing mat for release elements on bars. Matting must be removed after release move.
    - b. National Qualifiers, Classics and the HOPES Championship competitions.
      - 1) Junior International and HOPES athletes may use a skill cushion (maximum thickness of 8") in addition to the competition landing mats for release elements on bars. The mat must be moved in and out for the release skill without obstructing the judges' view.
      - 2) Junior and Senior International and HOPES athletes may place a manufactured sting or 10 cm (4") "throw" mat under the bars during competition. This matting cannot be moved.
      - 3) For all levels, an 8" skill cushion may be used in the bar dismount area for compulsory competition.
  - 3. Beam
    - No supplemental matting for optional competition. A skill cushion should be available during warm ups.

## Chapter 10

4. Floor Exercise
  - a. USA Championships: No additional matting other than FIG specifications may be used.
  - b. Classics Competitions:
    - Up to two manufactured sting mats or 10 cm mats are allowed to be placed separately on the Floor Exercise area. Whenever additional matting is placed on the Floor Exercise area and covers any portion of the boundary line(s), the mat must be clearly marked with tape or chalk to indicate the actual boundary line(s). Sting mats can be removed or remain on the floor throughout the routine. Floor matting must be placed prior to the start of the floor routine. A mat cannot be added once the gymnast has begun.
  - c. National Qualifiers:
    - Up to two manufactured sting mats or 10 cm throw mats are allowed to be placed separately on the Floor Exercise area. Whenever additional matting is placed on the Floor Exercise area and covers any portion of the boundary line(s), the mat must be clearly marked with tape or chalk to indicate the actual boundary line(s). Mats can be removed or remain on the floor throughout the routine. Floor matting must be placed prior to the start of the floor routine. A mat cannot be added once the gymnast has begun.
- C. Springboard/Mounting Specifications
  1. Only unaltered manufactured vaulting boards that meet FIG specifications are approved for USA Gymnastics competitions.
  2. A board used to mount Bars or Beam may be placed on the 20 cm competition landing mat. The board may also be placed on the mandatory 10 cm supplemental dismount landing mat. If the mount and dismount are in the same location, the board MUST be placed on the 10 cm supplemental dismount landing mat. No matting may be moved after the routine begins.
    - a. For international athletes Beam and Bars will use only one board (soft).
    - b. For HOPES athletes Beam and Bars boards you may remove springs to adjust to the Hopes athlete. You must return the spring as soon as your athlete is finished on that event.
- D. Vaulting:
  1. For the International Level athletes there will be two springboard configurations. AAI boards are soft 6 springs (3-1-2) and hard 8 springs (3-3-2). Springs may not be moved or replaced.
  2. For the HOPES athletes, there will be two springboard configurations used at Vault. A five (2-1-2) and six spring (3-1-2) for vault. Springs may not be moved or replaced.
- E. Make sure all reasonable safety measures are considered. Examples:
  1. Each competitive area must have its own physical space and may not overlap with another competitive area.
  2. There cannot be any obstructions on the Floor Exercise Area.
  3. There must be sufficient room for mounting, dismounting, and vaulting areas.
  4. Procedures for the removal of blood and disinfection of the apparatus: A solution of 1-part bleach and 10 parts water (or an Anti-viral spray disinfectant) should be available for the removal/disinfection of blood from the apparatus or matting.
- F. Conversion for inches to centimeters:

Approx.	$\frac{3}{4}$ inch	=	2 cm
	4 inches	=	10 cm
	8 inches	=	20 cm