

NEOQI®

Mediq

ENG

Thank you for choosing NeoQi®

Main features in NeoQi® Mediq

Creativity

You can combine between several possibilities to have a small SPA.



Sensor buttons

Functions can be activated by gentle touch of a button.



Ergonomic design

Every part of cocoon is made to suit your special needs to relax.



Main features in NeoQi® Mediq



Steam

cleanses the skin and improves its structure (elasticity, color), increases the receptiveness of the skin to active ingredients contained in cosmetic products.



Infrared radiation

provides deep, safe and revitalizing warming of all organs and tissues, improves the metabolism, stimulates sweating, removes toxins from the body.



Vichy shower

resembling a heavy rain, provides gentle massage of reflex zones, improves blood circulation and has lymphatic drainage action, affects the nervous system in a positive way.



Vibrating table

improves and stimulates regeneration processes, helps to eliminate waste products, has a positive effect on the neuro-muscular system.



Air bubble massage

gently affects a number of nerve endings and receptors, improves peripheral circulation, saturates tissues and organs with oxygen.



Water massage

by means of water jets with different direction, forces and temperatures. Has restorative, relaxing, analgesic effect on the human body.



LED light

represents the active energy that impacts on our psycho-emotional processes.



Music system

specially composed music accompaniment that has a positive impact the perception of the treatment.

Table of content

PRECONDITIONS. SET UP.

QUALITY REPORT	11
PRECONDITIONS FOR INSTALLATION	17
ELECTRIC CONNECTION	21
WATER CONNECTIONS	21
INITIAL WARM-UP SESSION	22
MAINTENANCE	23
WATER SYSTEM CLEANING	24
STEAM GENERATOR CLEANING	24
TERMS OF WARRANTY	25
MARKINGS ON EQUIPMENT	27
GUIDE FOR ERRORS ON SCREEN	28

INTRODUCTION. CAUTIONS.

INTRODUCTION	33
PHILOSOPHY OF NEOQI®	34
IMPORTANT CAUTIONS AND USER SAFETY INFORMATION	35
HEALTH PRECAUTIONS	36

GETTING STARTED. USING YOUR COCOON.

BASIC COMPONENTS OF YOUR COCOON	41
FUNCTIONS ON CONTROL PANEL A (UPPER PART OF EQUIPMENT)	45
WARM-UP SESSION	45
STEAM SAUNA	47
AROMATHERAPY	48
INFRARED SAUNA	49
FACE FAN	50
VICHY SHOWER	51
VIBROMASSAGE	52
CHROMOTHERAPY	53
TIMER	54
FUNCTIONS ON CONTROL PANEL B (LOWER PART OF EQUIPMENT)	55

HYDROTHERAPY TUB	55
WATER MASSAGE (ZONE I)	55
WATER MASSAGE + UNDER WATER MASSAGE HOSE (ZONE II)	56
WATER MASSAGE (ZONE III)	57
BOTTOM AIR	57
CHROMOTHERAPY	57
OZONE	58
HAND SHOWER	58
BLUETOOTH AUDIO	59

TREATMENTS. THERAPIES. AFFECTS.

STEAM SAUNA	63
AROMATHERAPY	65
INFRARED SAUNA	66
HYDROFUSION	69
VICHY SHOWER	70
VIBROMASSAGE	71
HYDROTHERAPY	73
CHROMOTHERAPY	74
MUSIC THERAPY	76

1

Preconditions.

Set up.

QUALITY REPORT
NeoQi® Energy Cocoon

Serial Number: _____

Pre shipment inspection

Pre usage inspection

Date: _____

Physical aspects

body surfaces _____

components _____

technical condition _____

Functional test

control panels _____

steam sauna _____

Infrared sauna _____

Vichy shower _____

vibrating table _____

face fan hand _____

shower _____

music system _____

LED lamps _____

Checked by: _____

Before starting to use the unit, please fill out this form and fax or mail it back to NeoQi AS.

Ph: +372 688 9100 Fax: +372 688 9101 Add: Piirimäe 15, Tännasilma, Saku vald 76406, Estonia

NeoQi AS
Piirimäe 15, Tännassilma
76406 Saku vald
Estonia
Ph. +372 688 9100

SERVICE REQUEST

DATE:

NUMBER:

DISTRIBUTOR'S NAME:

CUSTOMER'S NAME:

Equipment's Serial Number: **Harmony Mediq:**

Date Equipment Received:

Date Equipment Delivered:

Date Equipment Started operating:

Date Problem Occurred:

Problem Report:

Person Reporting.....



NeoQi AS
Piirimäe 15, Tännassilma
76406 Saku vald
Estonia
Ph. +372 688 9100

SERVICE REQUEST

DATE:

NUMBER:

DISTRIBUTOR'S NAME:

CUSTOMER'S NAME:

Equipment's Serial Number:	Harmony Mediq:
----------------------------	-----------------------

Date Equipment Received:

Date Equipment Delivered:

Date Equipment Started operating:

Date Problem Occurred:

Problem Report:

Person Reporting.....

Preconditions for Installation

Room

Equipment is designed for use in indoor conditions.

The room, where the equipment is used should be moisture proof. Ventilation is recommended, as in the working regime the machine creates humidity.

It is recommended to have a general drain on the floor.

Doors must be wide at least 80 cm.

Power

Power cord material at least **3 x 2,5 mm²** copper crosscut.

Power cord should be connected into the moisture proof junction box which is located on the frame of the equipment.

Maximum power consumption for equipment at a time is **3,9kW**.

Protective device current in front of equipment feeder not less than **20A**

Water

2 water pressure hoses are required one for hot, another for cold water with one ending being 3/4 threaded

Length of hoses depend upon the distance from the water inlets

Drainage connection on the floor should be Ø 50 mm; Water drainage hose should be of Ø 50 mm. Length of drainage hose depending on the distance from drainage opening on the ground.

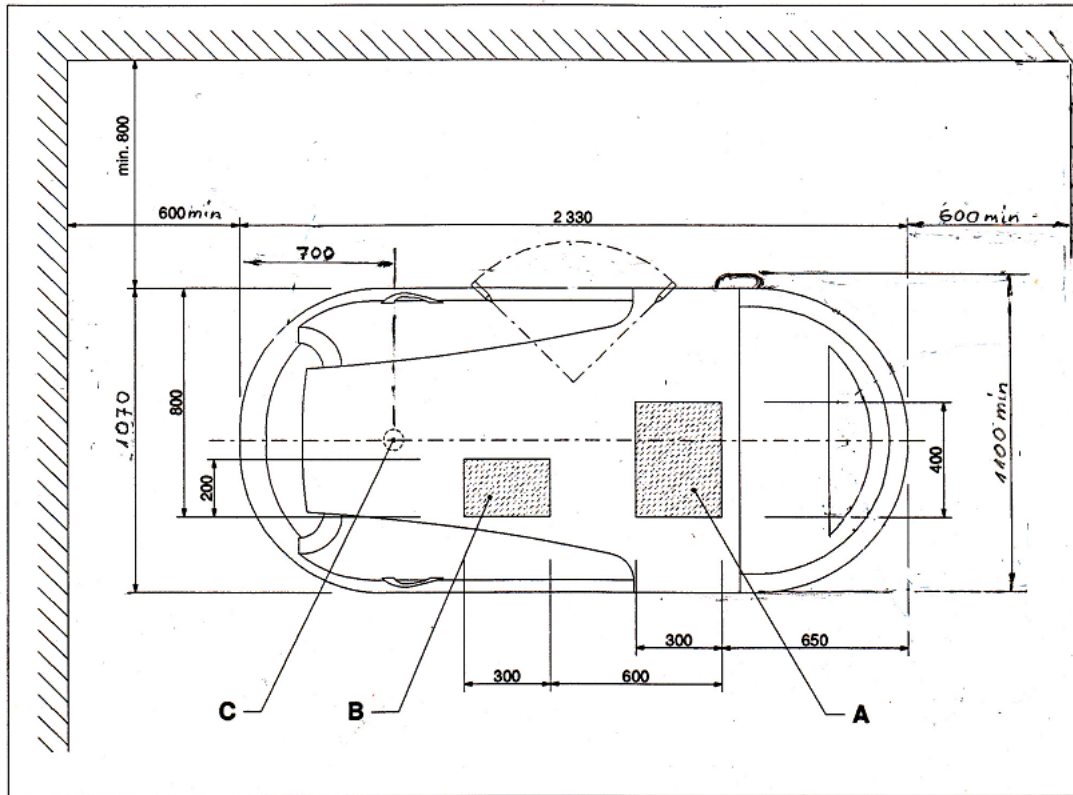

Figure 1

Legend for Figure 1

- A- area for the closable water inputs $G^{3/4}$ and for the water outlet $\downarrow 50$ mm on the same level with the floor
- B- area for the mains cable $3 \times 2,5$ mm² with free cable-end of minimum 2,0 m and the earth-connection cable 4mm² with free cable-end of minimum 2,0 m
- C- equipment's drainage
- D, E- bath filling faucets ($G^{3/4}$)
- F- thermostatic-mixer for Vichy and hand shower
- G- massage function diverter
- H- faucet for turning the Vichy shower and the hand shower on/off and regulating the water pressure

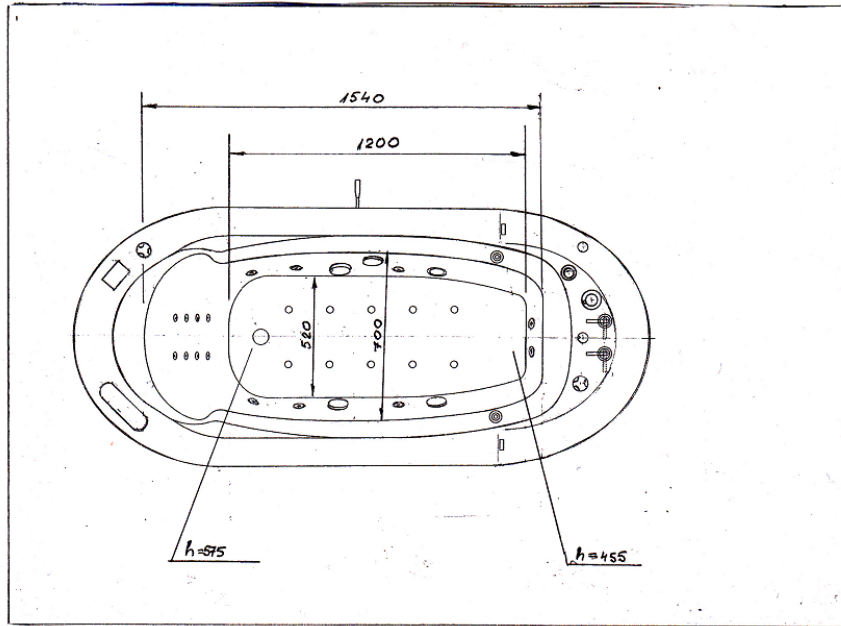

Figure 2

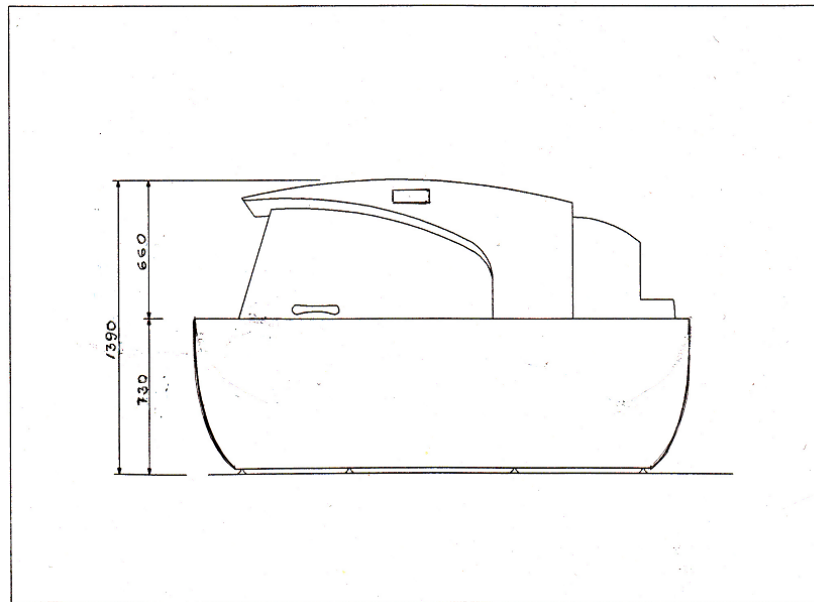

Figure 3

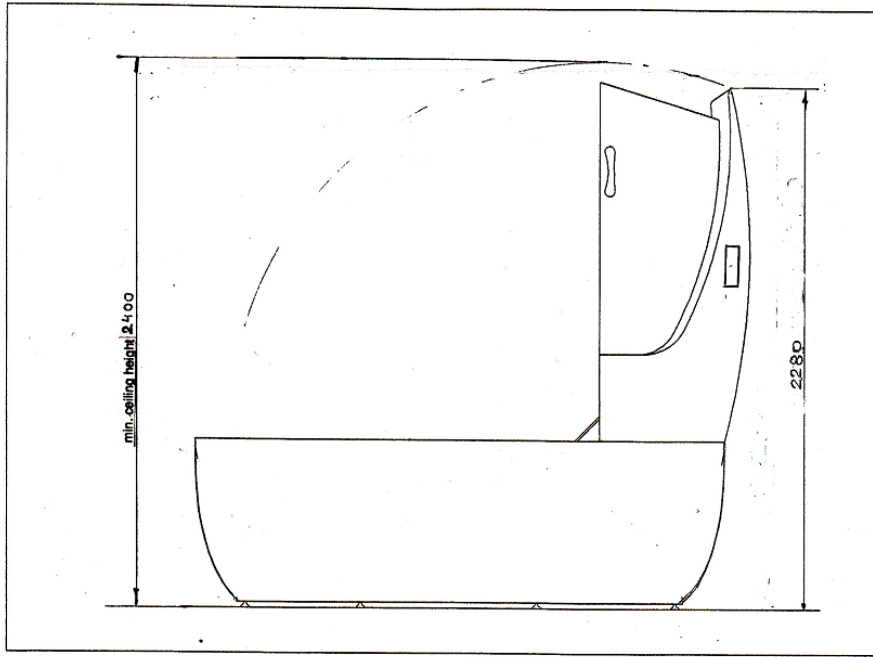

Figure 4

Electric Connection

Electric installations of NeoQi® Harmony Mediq should be carried out by qualified specialists or official representative of NeoQi® AS.

NeoQi® Harmony Mediq is CLASS 1 EQUIPMENT in which protection against electric shock does not rely on BASIC INSULATION only, but which includes an additional safety precaution, which implies that the EQUIPMENT must be connected to a protective earth conductor in a fixed wiring, in such a way that accessible metal parts

cannot become live in the event of a failure of the basic insulation.

NeoQi® Harmony Mediq belongs to the group of TYPE B EQUIPMENT, which provides a degree of protection against electric shock, which implies:

- allowable leakage current (10 mA);
- reliability of the protective earth connection.

NeoQi® Harmony Mediq cannot be used if the air contains FLAMMABLE ANAESTHETIC MIXTURE WITH AIR or WITH OXYGEN OR NITROUS OXIDE.

Water Connections

The installation of warm and cold water inlets and drainage connections of NeoQi® Harmony equipment should be carried out by qualified specialist or official representative of NeoQi® AS.

For proper functioning of the equipment only clean tap water should be used. In case the tap water contains high percentage of abrasive substances or rust, it is recommended to install a water filter.

Initial Warm-Up Session

Turn on the device by pressing main ON/OFF button.

Close the hood of the equipment and switch on the steam sauna (**STEAM**) function from the upper control panel. The following icon will appear on the screen in a small frame.



Select the maximum steam temperature by pressing +/- buttons until the steam icon appears in the frame. Set temperature to 48°. The timer will automatically set itself to 30 minutes.

After the steam session has stopped, switch on the infrared sauna (**INFRARED**) function from upper control panel. The following icon will appear on the screen in a small frame.



Select the maximum infrared temperature by pressing +/- buttons until display shows 50° C. The timer will automatically set itself to 30 minutes.

Fill the tub with water, closing the tub drain first by sliding the drainage valve into the left-side position.

Open the cold and the hot water taps. When the water level reaches ~ 1 cm above the back jets, close the water inlet. Now switch on all the hydrotherapy functions of the tub from the lower control panel for 5 minutes:



Close the hood of the equipment and turn on the first program of the Vichy shower (**VICHY SHOWER**) for 5 minutes.



Empty the tub and aerate the equipment (turn on air blower for 1 minute - water will be thrown out from the bottom jets). Now the equipment is ready to use. In case any of the functions will not operate please contact the local dealer.

Maintenance

Regular maintenance for certain parts is essential for long life and faultless functioning of the equipment. Routine maintenance ensuring safe operation includes cleaning, disinfection and visual control of general condition of the equipment.

Routine maintenance consists of cleaning the water system of the bath and the steam generator of the cocoon.

NB! Before using the equipment and composing the maintenance plan, the general quality and hardness of the water must be assessed.

In case of low quality water (high contents of limestone, iron, abrasive particles etc.), the installation of an appropriate water filter is required. The frequency of cleaning the steam generator is directly dependent on the hardness of water.

The warranty will be voided if maintenance is carried out non-systematically and only upon necessity.

Try to avoid scratching the acrylic surface with hard elements (sand, jewelry, accessories, etc.). Do not drop heavy and hard objects on the surface of the device.

Water System Cleaning

The cleaning of the water system of the bath (jets, pumps, and pipes) needs to be carried out as required, but no less than after every 50 sessions.

Steam Generator Cleaning

In order to compose the maintenance plan for the steam generator cleaning, the general quality and hardness of the water must be assessed. We recommend performing a Vital Easytest.

TOTAL HARDNESS	GERMAN	WATER CHARACTERISTICS	SERVICE SCHEDULE
< 5TH	<3° dH	Very soft water	After every 500 work hours
>7 TH	>4° dH	Soft water	After every 150 work hours
>12TH	>7° dH	Semi hard water	After every 50 work hours
>25TH	>14° dH	Hard water	Aster every 15 work hours
>35TH	>21° dH	Very hard water	Install water filter

Other Technical Details

The fuse rating utilized in the main external power supply circuit of stationary installed equipment:

Circuit breakers 20A

Used equipment cannot be transported or stored below 0 degrees C.

Minimum required water capacity to operate the hydrotherapy tub should be ~ 1 cm above the back jets.

Maximum allowed load on the vibrating table is 175 kg.

Terms of Warranty

NeoQi® energy cocoon is warranted to be free from defects in material or workmanship for parts and labor. The equipment warranty period is calculated from the date of issue of the commercial

invoice, for a period of 1 (one) year. The warranty for the spare parts, replaced during repairs under warranty, is valid until the end of the warranty period of the equipment itself.

- The basis for the warranty is a correctly filled warranty blank or a commercial invoice.
- The warranty applies only to the repair and replacement of defective components and does not apply to any other direct or indirect expenses or damage, caused by a defect or malfunction of the equipment.
- The warranty is valid if the equipment was regularly serviced (see service chapter in the user manual) and used according to the manufacturer's instructions as given in the user manual
- In the event of an unjustified service call, the transport charges are paid by the client.

The warranty does not apply in the following cases:

- In case the purchase documents are missing.
- Improper or negligent use of the equipment (see the service manual of the specific model); normal wear and tear; damage and defects, inflicted during an inappropriate connection of the equipment to the water and power supply, drainage and ventilation, as well as the installation of the equipment into the room
- Damage/malfunction, caused by the low quality of the water being used (for example limestone, abrasive particles, iron etc.)
- Mechanical damage (for example, infrared lamps), caused by improper handling while transporting and/or using the equipment
- Direct and/or indirect damages and/or expenses caused by voluntary/involuntary actions or inactions of the client (for example, not installing a water filter to achieve an adequate quality of water).
- A repair, disassembly and/or modification attempt carried out by unqualified personnel, other than qualified NeoQi® or its distributor representative.
- Causes independent of the manufacturer (vandalism, lightning, flood, fire, voltage surges and spikes, short circuit, freezing etc.)
- In case abrasive heavy-duty cleaning agents have been used, as well as substances that can chemically damage acrylic and polycarbonate parts.

The warranty does not apply to the following components and works

- Warranty works exclude:
 - The cost of transport to the equipment/site.
 - Elimination of damage to the equipment that has suffered from drainage, power and water supply breakdowns.
 - Works related to clearing the space for a working area (0.5 meters around the equipment).
 - Connecting necessary service lines to the equipment.
- Repairs of minor damage (for example, scratches), which do not influence the functionality of the equipment.
- Expendable materials (such as the steam generator, the quartz infrared tubes, filters, showerheads, pressure hoses etc.)
- Repairing damage inflicted by means of transportation not belonging to the manufacturer.
- Repairing damage caused by improper handling and/or storing by the customer.
- The cost of works and components related to the ordinary use and normal wear of the equipment:
 - Regular cleaning of the steam generator, replacement of heating elements.
 - Everyday maintenance, cleaning of the device.
 - Replacement or cleaning of the drainage pipe.
- Eliminating defects and malfunctions caused by ignoring the installation requirements and user manual instructions.
- Equipment maintenance (cleaning, setting, servicing etc.) that are listed in the user manual.

Any other claims, in particular, claims for compensation for any damage not applicable to the appliance itself or that have arisen as a consequence of an excessively delayed repair work or replacement parts delivery, are not accepted.

Markings on Equipment

All products of NeoQi® comply with the requirements of the European Union.

1. CLASS

EQUIPMENT in which protection against electric shock does not rely on BASIC INSULATION only, but which includes an additional safety precaution. EQUIPMENT must be connected to the protective earth conductor in the fixed wiring of the installation in such a way that accessible metal parts cannot become live in the event of a failure of the basic insulation.

2. Type B

NeoQi® Harmony Mediq belongs to the group of TYPE B EQUIPMENT, which provides a degree of protection against electric shock, which implies:
allowable leakage current (10 mA);
reliability of the protective earth connection.

3. IPX5

According to the degree of protection against harmful ingress in the water the equipment provides protection against WATER JETS.
Marking is located on the bearing aluminum frame on the underside of the equipment.

4. Certificate of Conformity

The CE Marking indicates conformity of the equipment with Directive 2006/95/CE and 2004/108/CE



5. ATTENTION: Examine the attached documentation!

Marking located on the cover of the equipment

Guide for ERRORS on Screen

If the screen of your cocoon displays an error message and you can hear unusual sounds, this indicates a failure in the operation system. In general such problems relate to failure of the steam generator. It should be noted that regular maintenance of the equipment preclude such malfunctions.

CONTROL PANEL IS BLIND

Problem:

You are trying to turn on the equipment, but ON/OFF power switch does not respond.

Solution:

Disconnect the device from main power supply. Wait for 10 seconds and put machine back into circuit.

ERROR 1

Problem:

Displayed on the screen as E1. This is a malfunction of the temperature sensor if it breaks out or a short circuit occurs. At the same time you will hear a sound: "Du, Du, Du ...". The control panel buttons will not work.

Solution:

Disconnect and reconnect the device. If the problem persists, turn off the device from the main power supply of and replace the temperature sensor.

ERROR 2

Problem:

Displayed on the screen as E2. This is an alert from the water level sensor in the steam generator. This error appears 60 seconds after the activation of the steam function. The screen will display E2, you will hear a sound: "Du, Du, Du ..." and the control panel will not respond. The problem appears if there is no water in the steam generator, the water level is too low or if the water level sensor is dirty.

Solution:

Make sure that the steam generator is filling up correctly. Check if the water supply is connected to the device. Perform steam generator cleaning - water level sensor may be dirty and not be able to send a reading of the level of water. If everything is well with the water supply and there is no response, check the steam generator data cable, perhaps some of the contacts of the water level sensor cables have eased.

ERROR 3

Problem:

Displayed on the screen as E3. This alarm is connected to the water level sensor error (E2). If the signal E2 was present on the screen for more than 2 minutes, the display will signal E3. You will hear a sound: "Du, Du, Du ..." and control panel will not respond.

Solution:

Make sure that the steam generator is filling up correctly. Check if the water supply is connected to the device. Perform steam generator cleaning - water level sensor may be dirty and not be able to send a reading of the level of water. If everything is well with the water supply and there is no response, check the steam generator data cable, perhaps some of the contacts of the water level sensor cables have eased.

ERROR 5

Problem:

Displayed on the screen as E5. It appears in case the steam generator heating element is overheating – if the temperature is over 108°C. When there is no water inside of the steam generator, the heating element will be turned off to protect it from overheating. You will hear a sound: "Du, Du, Du ..." and the control panel will not respond.

Solution:

Stop the function, wait until the heater has slightly cooled down. Check the water supply to the steam generator, it might not be filling correctly.

ERROR 6

Problem:

Displayed on the screen as E6. This occurs when water cannot leave the steam generator after the steam treatment. There will be E6 on the screen, you will hear a sound: "Du, Du, Du ..." and the control panel will not respond.

Solution:

Disconnect the device from main power supply. Check the drain valve, it may be stuck inside the socket or does not receive the required voltage of 12V.

2

Introduction.

Precautions.

Introduction

Congratulations! You are now the owner of the newest addition and innovation of NeoQi® SPA equipment - the energy cocoon Harmony Mediq.

NeoQi® methods are inspired by ancient philosophy and life science, thanks to which NeoQi® energy cocoons allow you to restore the balance of your body.

NeoQi® energy cocoons offer a wide variety of therapeutic treatments that are suitable for different personal needs and are tailored to resolve specific problem encountered by each client. NeoQi® energy cocoons respond to new demands on the market by combining treatments with a total wellness approach.

NeoQi® treatments are aimed at providing all around holistic treatment. This method does not only address beauty, but also well-being and complete body relaxation. It is inspired by energy treatments that eliminate muscular and vascular tension and release vital energies (circulatory, drainage, nutritive).

NeoQi® energy cocoons are top class multifunctional machines, which simultaneously perform a number of combined functions that help to:

- reduce stress by establishing balance
- stimulate senses to cause you to feel healthy and relaxed,
- prevent and treat illness
- regulate metabolism, balance your weight
- integrate mind/body and spirit

The NeoQi® Mediq energy cocoon features the following unique combination of functions in one single piece of equipment:

- Water (Hydrotherapy) massage
- Air bubble massage
- Handheld jet feature for performing underwater massage
- Steam sauna
- Infrared sauna
- Vibromassage table
- Aromatherapy feature
- Vichy shower
- Bluetooth Music system
- Facial fan
- Hand shower

NeoQi® energy cocoons promote rejuvenation, longevity and all around wellbeing. The therapies are suitable for men and women, of all ages and fitness levels.

NeoQi® energy cocoons have been developed with the highest criteria concerning quality and safety. Use this product only for its intended use as described in the current manual. NeoQi® Harmony Mediq equipment must be used in accordance with the operating instructions.

In order for us to provide better service, please record the model and serial number in the space provided below. The number can be found on the backside of the equipment cover. Kindly provide these numbers whenever you call to the customer service or contact your dealer.

Philosophy of NeoQi®

The invisible life energy - **Qi** flows through everything in life. It is the vitality, breath, and essential animating life force of the universe.

The free energy flow will make you feel vibrant, stay fit and healthy - both mentally and physically. You feel invigorated in every moment of your life.

However, if the energy becomes stagnant or blocked, erratic and undisciplined (due to an unhealthy lifestyle or weakness in an interior organ) you will most likely fall ill. Blocked or inhibited **Qi** causes dysfunction in the body's internal organ systems.

We humans are able to detect imbalances in ourselves and take steps to redress them - without the need to seek professional help. This will become the ultimate form of preventative medicine, gently healing emotional trauma. We will be able to uncover the psycho-spiritual traumas, which underlie much of modern illnesses, before they become a physiological problem.

NeoQi® therapies help you to replenish and free the circulation of *Qi*, restore health and to find new life energy. Each session produces sensations and feelings of *well-being, relaxation and calmness*. Mental fitness is improved through reduction of stress.

NeoQi® energy cocoons also benefit healthy people, being a *powerful tool for*

preventative medicine, allowing to maintain health, as well as improve it.

NeoQi® energy cocoons - the unique sensation you can experience in your own privacy, in a safe, comfortable, calming environment.

NeoQi® helps you maintain your inner balance.

Understanding and accepting the energy will become natural part of our everyday life. Once you can sense vital energy, you can begin to work with it - helping to move it in the most beneficial way.

The energy secret lies in exploring and enhancing your physical, emotional and spiritual energy.

As our lives become ever more demanding, we all have to make the choice. We can turn our backs on the energy equation and just get by, or we can tap into the infinite possibilities of the energy and start to live our lives on a whole new dimension.

NeoQi® treatments offer a step towards the understanding of the energy concept.

Choosing to live with the knowledge of energy concept is to tap into an endless source of personal power and joy.

It is a lifestyle choice of the new millennium - affecting every area of daily life in the deepest possible way.

Important Precautions and User Safety Information

When operating this system, the following procedures must always be followed:

IMPORTANT: Read carefully the Section 2 of this manual - "General Instructions and Health Precautions" - to avoid any health risk or adverse effects of using the cocoon!



WARNING:

Do not stay in a high temperature sauna or in a very hot bath for too long. First time users should get accustomed to the system, prior to experiencing longer sessions.

For hygienic reasons, all bathers should shower and thoroughly wash their body prior to use of the system.

To reduce the risk of injury, do not allow children, the elderly or mentally/physically challenged persons to use this system without close supervision by qualified personnel at all times.

Safety, reliability and performance of the NeoQi® equipment can be guaranteed only if:

- The installation and other actions, including modifications and repairs are performed by qualified specialists or official representatives of NeoQi® AS.

- The installation is carried out in accordance with the applicable rules and regulations listed in the part "Preconditions for installation" of the current manual.

Do not use the equipment if the power cord is damaged, if it is not functioning properly, if it has been dropped or damaged. Contact NeoQi® AS service center for inspection and repair.

Avoid the contact of the power cord with hot surfaces.

Use only clean tap water.

Do not insert any objects into the openings of the equipment.

Prolonged immersion in a hot sauna or bath might induce hyperthermia.

Individuals in a state of alcohol or drug intoxication are forbidden from using the system, as it significantly increases the risk of fatal hypothermia.

People with an adverse medical history or using medication should consult their physician before using this system. Pregnant or possibly pregnant women should consult their physician before using this system.

Health Precautions

Treatments in NeoQi® energy cocoon are contraindicated in the cases mentioned below:

- Acute trauma, inflammation
- Fever
- Acute inflammatory and allergic skin disease, wounds
- Cardiovascular insufficiencies, heart disease, hypertension
- Impaired circulation
- Bleeding diatheses
- Advanced diabetes, esp. Type I
- Oedema
- Large scars
- Impaired sensation
- Malignancy
- Cognitive or communication deficits that hinder reporting discomfort, pain
- Pregnancy

Please consult with your physician whenever uncertain about any condition or response.

!! Post treatment rest period –

Treatments involving heating the body must be followed by a rest period with a duration of at least half an hour, in order to enable the body to get back to a normal temperature.

!! Should any condition get worse, stop using the NeoQi® cocoon immediately.

Cardiovascular insufficiencies, heart disease - Hot and cold applications that increase the heart rate and pressure are contraindicated, as it may overload an already weakened heart.

Hypertension (High blood pressure) - Hot and cold applications that increase the heart rate are contraindicated due to overload of the heart.

Cancer – Treatments for clients with cancer should be carried out with caution. It is strongly recommended that you work with a client only with the consent of his physician.

Haemophiliacs and anyone predisposed to haemorrhage should avoid any type of hot and cold treatments, caused vasodilation increases the risk of bleeding.

Reduced sensitivity - Any state with reduced sensitivity is a contraindication for a treatment, as the client is not be able to feel if the skin is too cold or too hot.

Weakness – Heat therapy may be contraindicated for a client who is feeling weakness as a treatment may worsen the condition.

Anaemia - Hot body treatments can increase cellular oxygen demand, which cannot be satisfied with anemia.

Skin lesions – Treatment is contraindicated in case of damaged skin or other irritation that may be exacerbated.

Such skin lesions as pustules, papules, infected blisters may rupture due to increased vasodilatation and are contraindicated.

Pregnancy - Full body hot treatments are contraindicated for pregnant woman, as they may be associated with occurrence of birth defects. This contraindicates the use of steady temperature hot full body baths, saunas, as well as local applications of heat to the abdomen.

If you are pregnant or suspect that you might be, stop using the sauna.

Connection between visiting saunas at low temperature with birth defects has not yet been proven.

Pacemakers – Vibromassage is contraindicated for people with pacemakers.

Epilepsy – Vibromassage is contraindicated for people with epilepsy.

Peripheral vascular disease – Underwater massage is contraindicated for venous disorders, thrombosis and varicose veins. Clients suffering from arteriosclerosis may have weakened or blocked arteries. Thermal procedures improve tissue metabolism and oxygen demand, therefore thermal treatments are contraindicated.

Pulse - Heart rate should not exceed 140 beats per minute as it may overload the heart. Heart rate can be controlled on the inner surface of the wrist.

Diabetes - Advanced diabetes, especially Type I (juvenile diabetes) may reduce the ability of the patient to feel the tissue damages, especially in the lower extremities. Vascular damage, that is a consequence of this disease, reduces blood flow to damaged tissues. Overheating of these areas is contraindicated. Please consult your physician.

Skin sensitivity – Cold water applications are contraindicated for clients who have previously suffered from frostbite, who have hypersensitivity to cold due to Raynaud's disease or have other conditions such as low blood pressure.

Hypothyroidism - Cold water applications are contraindicated for clients with hypothyroidism, since it slows down the primary metabolism.

Kidney problems - Cold is contraindicated in case of kidney malfunction or disease.

Inflammation - Heat applications are contraindicated in acute conditions of

inflammation such as bursitis, arthritis, tendonitis, sprains and strains.

Intense heating is strictly contraindicated in cases of **localized infections** whether dental, joint or any other case.

If you have recently had **an injury (or acute) infection** of the joint, it must not be heated during the first 48 hours after the trauma or as long as the fever and swelling subside. When intense heating of any kind is applied in case of chronic inflammation of the joints, possible painful reactions may occur.

It is not recommended to increase the temperature of the body for people with adrenal gland dysfunction, systemic lupus erythematosus, or multiple sclerosis.

Metal pins, rods, artificial joints or any other surgical implants generally reflect infrared rays and thus are not heated by this system. Stop using infrared function if you feel pain in the area of the implant.

Silicone absorbs infrared energy. Nose or ear silicone implants or prostheses may be heated up by infrared rays. Though, since silicone melts at the temperature above 200 °C, infrared sauna of NeoQi® does not damage it. Before using the system, it is recommended to consult with your physician.

!! Do not attempt to treat any disease with the help of an infrared sauna capsule NeoQi® independently, without supervision or without the help of a certified physician.

!! Do not attempt to treat any disease independently with the NeoQi® energy cocoon infrared sauna without supervision or without the help of a certified physician.

3

Getting Started.
Using Your Cocoon.

Basic Components of Your Cocoon

Features and functions of the upper part of the NeoQi® cocoon.

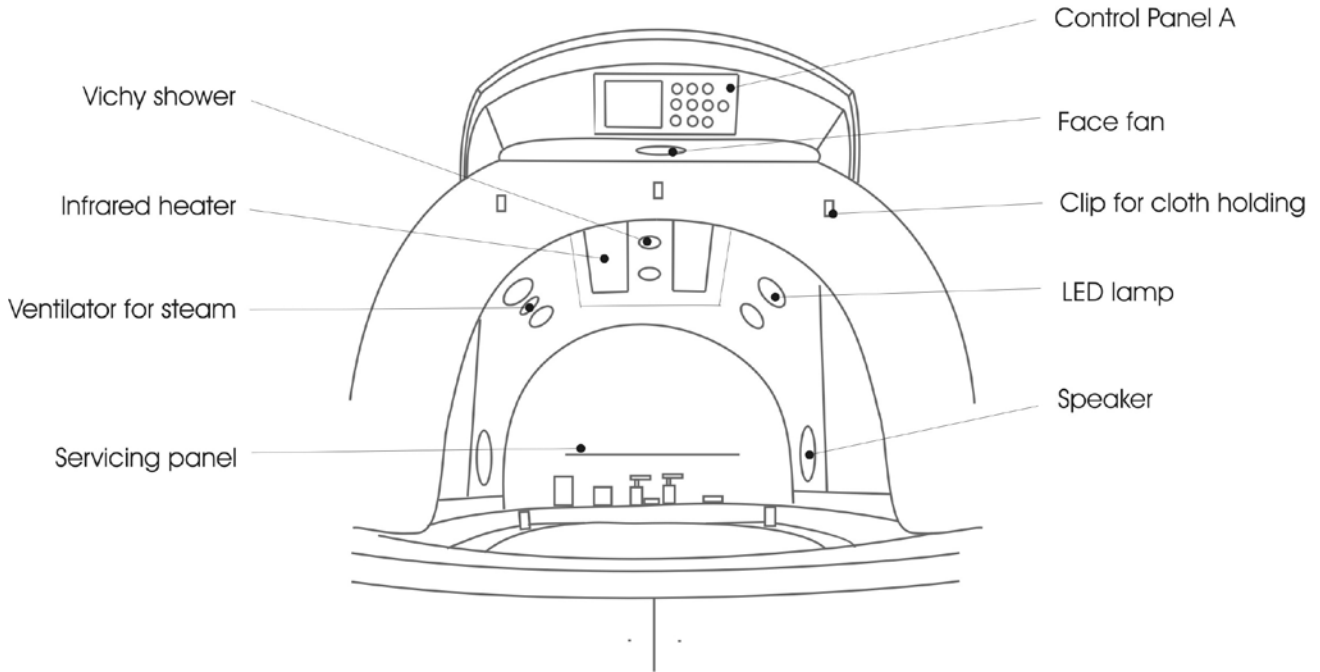

The upper part of the NeoQi® Harmony Mediq energy cocoon is operated by a digital control panel. **Control Panel A** is mounted on the console above the face and on the right upper side of the hood for the convenience of the therapist.

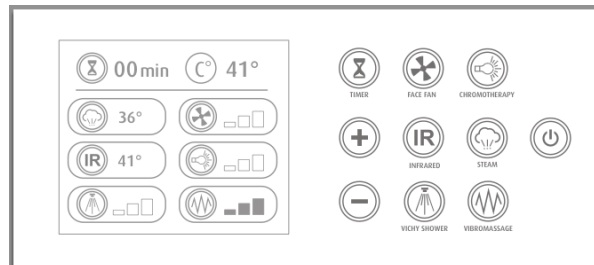

Features and functions of the lower part of the NeoQi® cocoon.

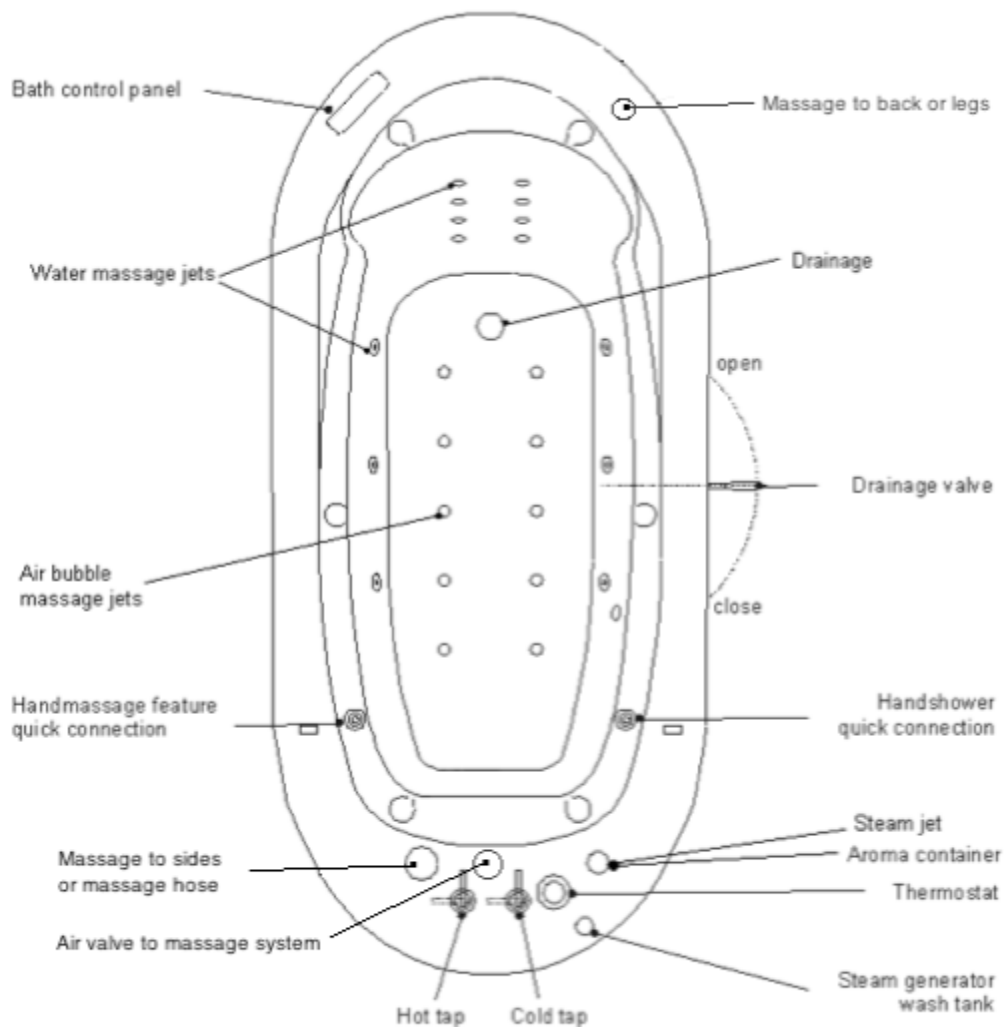

NeoQi® cocoon's lower part is operated by a digital control panel. **Control Panel B** is located on the bathtub.

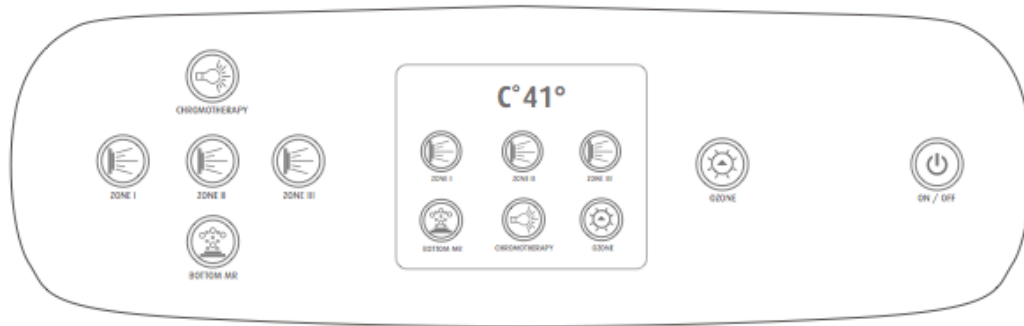

Remote control for bathtub.

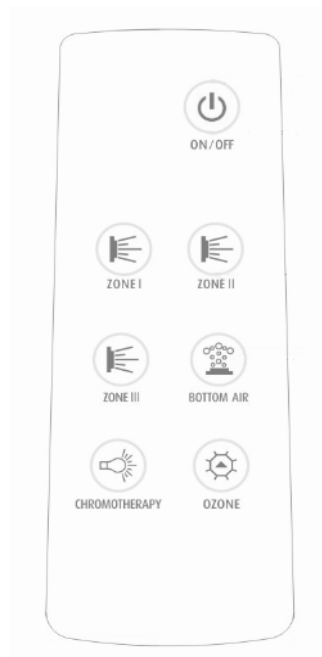

NeoQi® Harmony Mediq energy cocoon sound system is operated by a Bluetooth audio.

Changing batteries on the remote control:

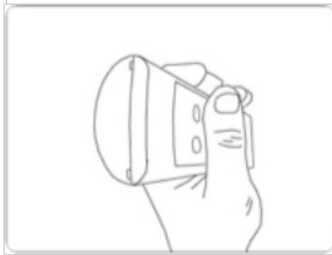

Shot 1: There are 2 small openings on the controller.

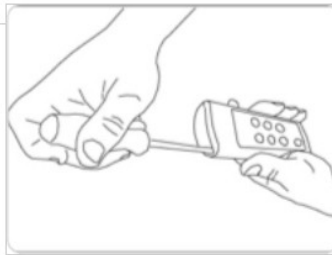

Shot 2: Put screwdriver into hole and bend it. Covers of controller will splitting.

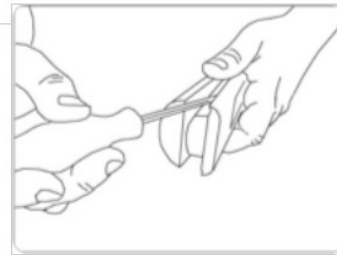

Shot 3: Move on by the edge with screwdriver until both sides should separate.

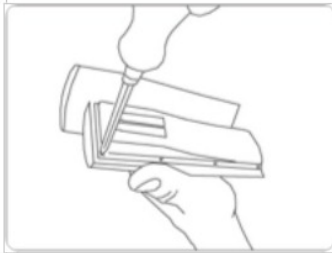

Shot 4: Open screws to remove transparent cover.



Shot 5: Replace 2 x AAA batteries

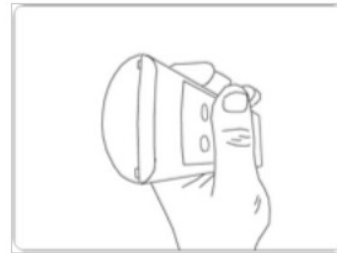

Shot 6: Do all backwards and controller is ready to use.

FUNCTIONS ON CONTROL PANEL A

(Upper part of equipment)

Warm-up session

Before the treatment:

First switch the machine ON using the ON/OFF button on the Control Panel.



IMPORTANT: All functions of the device can be switched off by pressing the ON/OFF button.

Client must be informed of the location and operation of the ON/OFF button prior to activating any functions!!

Prior to the use of the steam sauna, aromatherapy products and infrared sauna you need to warm up the upper part of the equipment, thus ensuring the maximum level of comfort for the client from the very beginning of the treatments.

Now switch on the steam function (**STEAM**) on the control panel A (see figure above) and select the desired temperature. It takes approximately 10 minutes to preheat the sauna. When the temperature has reached 39°C – the sauna is ready for use. The NeoQi® energy cocoon will automatically maintain this temperature level. Temperature can be modified throughout the session.

For hygienic reasons, all bathers should shower and thoroughly wash their bodies prior to using the system and wear disposable underwear during the session.

Consider the specific needs of your client and confirm the plan of the treatment session with the client.

During the treatment:

After the warm-up cycle has been completed, the cocoon's hood can be opened and the client may lie down onto the vibrating table. The cocoon's hood should be closed slowly and carefully. **IMPORTANT: Safety precautions must be followed when placing client into the cocoon, especially when opening and closing the cocoon's hood.**

The energy cocoon should be operated at all times either in fully opened (hood is resting fully back against the hinge stops) or fully closed position.

Once the client is comfortably positioned on the vibrating table, the cocoon's hood can be slowly and carefully lowered, making sure that the head, arms and legs of the client completely fit within the energy cocoon. Never leave the cocoon's hood in a partially open or closed position!

Please remind the customer that during the treatment it is possible to lie on the back (supine), abdomen (prone) or on one side.

Now you can turn on the necessary features to start the treatment in a NeoQi® energy cocoon.

To ensure even greater comfort during a sauna session it is possible to turn on the face fan function (**FACE FAN**), which is just like gentle breeze that enhances the pleasant feeling throughout the treatment, by retaining a free, regular and peaceful breathing rhythm.

Please make sure that your client is comfortable during the treatment, if necessary, adjust the temperature.

We strongly recommend that you start with sessions with lower temperatures and after the body gets used to the heat, it can be increased.



WARNING: Be careful with the steam jets! Do not place your legs on or too near steam outlet!

After the treatment:

After the sauna client can use a hand shower. In that case you should provide him with all the necessary instructions before the treatment, thus avoiding unnecessary worries and discomfort for your client.

For the independent use of the hand shower the hood of the cocoon must be opened and the client should be in the sitting position.

The hand shower must be connected with a special quick-connection - insert the end of the hose into the slot (water will start to flow), water temperature can be adjusted from thermostat.

After the treatment, offer your customers refreshments – clean water or herbal tea. Remind to your client that after thermal treatments body needs some rest for at least half an hour, in order to allow it to return to a normal temperature level. Therefore the post-treatment rest period is especially important during the cold season to reduce the risk of catching a cold.

Steam Sauna

NB! The steam sauna should only be taken on the vibrating bed!

Place the vibrating bed onto the bath tub and plug in the power cord into the backside of the equipment.

After the warm-up cycle, the cocoon's hood can be opened and the client can lie down onto the vibrating table. The cocoon's hood should be closed slowly and carefully.

Place a special piece of cloth onto the opened area near the client's head. The Neck Cloth will prevent excessive steam escaping from the cocoon during treatment.

Neck Cloth is available in NeoQi® supporting products range.

To activate the steam function, press on the **STEAM** button on the Control Panel A.



Steam indicator will appear on the screen surrounded by a circle (steam will be generated within few minutes).

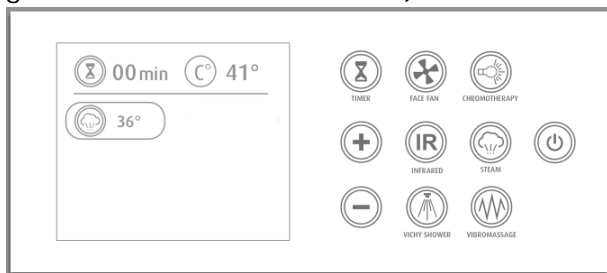

To select desirable temperature, press the +/- buttons on control panel A, while the

steam indicator is surrounded by a circle. You will see the temperature on the display.



WARNING: Be careful with the steam jets! Do not place your legs on or too near steam outlet!

The NeoQi® energy cocoon will automatically maintain this temperature level. Temperature can be modified throughout the session. For that, you must hold your finger for at least 2 seconds on the **STEAM** button, steam indicator will be surrounded by a circle and you can adjust the temperature by pressing the +/- buttons.



The temperature must be selected according to the individual needs of each person and we recommend to use lower temperature settings for the first sessions. The most commonly used temperature is between 38-42°C.

It is important to communicate with the client throughout the session to ensure that the selected temperature is comfortable.

If you open the hood of the cocoon during the session, the steam function will remain on. We recommend to stop the function before opening the hood.

To turn off the function, press the **STEAM** button.

Aromatherapy

Fill the special container attached on the steam nozzle with the desired water-soluble aroma emulsion. During the steam sauna session aroma from container will evenly spread inside of the energy cocoon.

After the session, rinse the container with water.

Aromatherapy can be achieved only together with the steam function on.

Do not touch steam nozzle and aroma container during the activated steam sauna function and shortly after the treatment - hot surface can burn your skin.



WARNING:

Please do not use concentrated 100% synthetic aroma liquids for the aromatherapy. They can seriously damage the acrylic surface of your device.

You can use water soluble aroma emulsions.

If you have any questions, please contact your local NeoQi® distributor.

The manufacturer's warranty does not cover acrylic surface damages caused by improper use of synthetic aroma liquids.

Infrared Sauna

NB! The infrared sauna should only be taken on the vibrating bed!

Place the vibrating bed onto the bath tub and plug in the power cord into the backside of the equipment.

NB! Infrared sauna and Vichy shower functions cannot work at the same time.



WARNING! Do not let water contact the IR heating element – it can damage the lamp.

After the warm-up cycle the cocoon's hood can be opened and the client can lie down onto the vibrating table. The cocoon hood should be closed slowly and carefully.

Place a special piece of cloth onto the opened area near the client's head. The Neck Cloth will prevent excessive steam escaping from the cocoon during treatment.

Neck Cloth is available in NeoQi® supporting products range.

To activate Infrared sauna function, press the **INFRARED** button on the Control Panel A.



Infrared indicator will appear on the screen surrounded by a circle. (You will feel heat after few minutes).



To select desirable temperature, press the +/- buttons on control panel A, while the infrared indicator is surrounded by a circle. You will see the temperature on the display.

NeoQi® energy cocoon will automatically maintain this temperature level. Temperature can be modified throughout the session. For that, you must hold your finger for at least 2 seconds on the **INFRARED** button, infrared indicator will be surrounded by a circle and you can adjust the temperature by pressing the +/- buttons.



The temperature must be selected according to the individual needs of each person and we recommend to use a lower temperature setting for the first sessions. The most commonly used temperature is between 38-42°C.

It is important to communicate with the client throughout the session to ensure that the selected temperature is comfortable.

If you open the hood of cocoon during the session, the infrared function will remain on.

NB! Infrared function must be turned off when opening the hood!

To turn off the function, press the **INFRARED** button.

Face Fan

To maintain normal breathing during a sauna session it is possible to turn on face fan function (**FACE FAN**).

To activate face fan function, press on the **FACE FAN** button on the Control Panel A.



Face fan will appear on the screen surrounded by a circle. (You will feel air flow on your face).

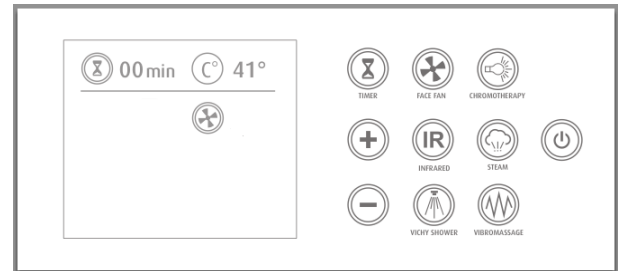

To turn off the function, press the **FACE FAN** button.

Vichy Shower

NB! The Vichy shower should only be taken on the vibrating bed!

NB! Do not fill the bath with water when the Vichy Shower operates from the water supply!

Place the vibrating bed onto the bath tub and plug in the power cord into the backside of the equipment.

NB! Infrared sauna and Vichy shower functions cannot work at the same time.

Before activating Vichy shower function check the water temperature set on the thermostat.



WARNING!

Vichy shower water temperature is the temperature set on the thermostat.

Water temperature can be adjusted in accordance with the wishes of the client and the purpose of the ongoing treatment.

After the warm-up cycle the cocoon's hood can be opened and the client can lie down onto the vibrating table. The cocoon hood should be closed slowly and carefully.

Place a special piece of cloth onto the opened area near the client's head. The Neck Cloth will prevent excessive steam escaping from the cocoon during treatment.

Neck Cloth is available in NeoQi® supporting products range.

To activate Vichy shower function, press the **VICHY SHOWER** button on the Control Panel A.



Vichy shower will appear on the screen surrounded by a circle. (Water will start to flow from Vichy jets).

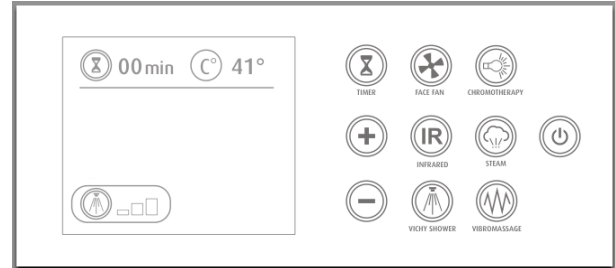

There are 3 speeds for Vichy shower:

1. Slowly changing water pattern for rehabilitation purpose
2. Medium speed
3. Fast change of water pattern, especially suitable for washing off cosmetic product (such as body scrub, body wrap etc.)

To select desirable Vichy shower speed, press the +/- buttons on control panel A, while Vichy shower indicator is surrounded by a circle. The display will show the speed selection.



It is possible to regulate the Vichy shower throughout the session. For that you must hold finger for at least 2 seconds on the VICHY SHOWER button, the Vichy shower indicator will be surrounded by a circle and you can adjust the speed by pressing +/- buttons. To change the area you want to massage with Vichy, adjust the Vichy jets' position manually.

To turn OFF the function, press **VICHY SHOWER** button.

Vibromassage

Place the vibrating bed onto the bath tub and plug in the power cord into the backside of the equipment.

NB! To avoid displacement of the vibrating table, please do not make any sudden moves when lying on the surface.

NB! Maximum load on vibrating table is 175 kg.

IMPORTANT!

The vibromassage function should be activated only when the client is lying on the table!

To activate vibromassage function, press on the **VIBROMASSAGE** button on the Control Panel A.



VIBROMASSAGE indicator will appear on the screen surrounded by a circle. (You will feel vibration).

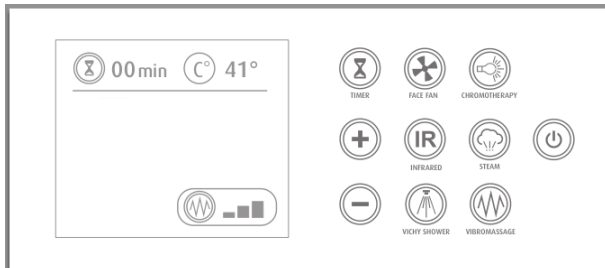

There are 3 positions of intensity of vibration:

1. Smooth vibration for ultimate relaxation and gentle stimulation of the metabolism processes
2. Medium speed
3. Intensive vibration for speeding up the metabolism and detox

To select desirable vibration speed, press the +/- buttons on control panel A, while VIBROMASSAGE indicator is surrounded by a circle. The display will show the speed selection.



It is possible to adjust the vibration intensity throughout the session. For that you must hold finger for at least 2 seconds on the VIBROMASSAGE button, the VIBROMASSAGE indicator will be surrounded by a circle and you will be able to adjust the intensity by pressing +/- buttons.

To turn OFF the function, press the **VIBROMASSAGE** button.

Chromotherapy

To activate the chromotherapy function, press on the **CHROMOTHERAPY** button on the Control Panel A.



Chromotherapy indicator will appear on the screen surrounded by a circle. (You will see the LED lights shining).

The chromotherapy will automatically activate the first program – a soft change between all the colors present in the device.

The order of the colors in the chromotherapy function:

1. Soft continuous shift between all of the colors.
2. Red
3. Green
4. Blue
5. Yellow
6. Indigo
7. Orange
8. Violet
9. White



If you wish to select only one specific color, you have to press the **CHROMOTHERAPY** button several times, until you see desired color.

To turn OFF the function, press the **CHROMOTHERAPY** button.

Timer

To change the session time setting, hold your finger on the **TIMER** button for at least 2 seconds, the **TIMER** indicator will be surrounded by a circle and you will be able to adjust the time by pressing +/- buttons.



Hand Shower

For independent use of the hand shower, the hood of the cocoon must be opened and client should be in a sitting position.

Hand shower must be connected by special quick-connection - insert the end of the hose into the slot (water will start to flow).

Water temperature can be adjusted from the thermostat.

When you do not need to use hand shower any more, disconnect it from the quick-connection by pressing the ring down.

FUNCTIONS ON CONTROL PANEL B

(Lower part of the equipment)

Hydrotherapy Tub

The hydrotherapy tub features are operated by the Control Panel B. First, switch the lower part of the equipment ON with the ON/OFF button on the Control Panel B.

Close the drain opening by moving the drain valve to the left position.

In order to fill faster, the Harmony Mediq energy cocoon has separate taps for hot and cold water. Open the taps by turning them clockwise. A few minutes after the tub is partially filled, you will be able to see the approximate temperature of the water on

the control panel. Referencing from the display, you can make adjustments to the water's temperature.

NB! Sauna and Hydrotherapy functions cannot be used at the same time.

NB! For any bathtub function the water level must be at least ~1 cm above the highest (back massage) jets!

Water Massage (ZONE I)

To use the function of water massage for back and feet, hold your finger for at least 2 seconds on the button **ZONE I** on the control panel B.

To turn the function off, press ZONE I button.

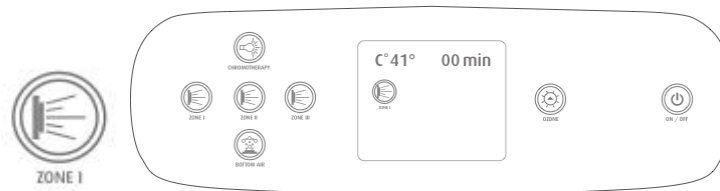

ZONE I has two positions - for back massage and for feet massage. You can set the desired massage position from the diverter on the left side of the bather's head location. You can choose to have either full power to

the back, full power to the feet or divide the power between the back and the legs.

To get a stronger water pressure effect, open the air valve for water massage. It is located near the bather leg position and you can access it through the small service panel.

Water Massage + Under Water Massage Hose

(ZONE II)

To use the function of water massage for the sides or for performing underwater massage, hold your finger for at least 2

seconds on the button **ZONE II** on the control panel B.

To turn the function off, press ZONE II button.



Zone II has two positions. One for side massage and the second for the underwater massage hose. You have to select a position on the regulator which is located near the bather's legs. Underwater massage hose starts to work, after being connected to its socket. Connect the hose, activate ZONE II and use diverter to direct all of the water

pressure to the massage hose. After use, switch off ZONE II and disconnect the massage hose. To get a stronger water pressure effect, open the air valve for water massage. It is located near the bather leg position and you can access it through the small service panel.

Water Massage (ZONE III)

This function is absent from Harmony Mediq.

Bottom Air

To use the bottom air function for air bubble massage, hold your finger for at least 2 seconds on the button BOTTOM AIR on the control panel B.

To turn the function off, press BOTTOM AIR button.

After every bathing, drain water and turn the bottom air function on for 30 sec. This will flush out the remaining water from the bottom air jets and will therefore prevent the development of microbes.

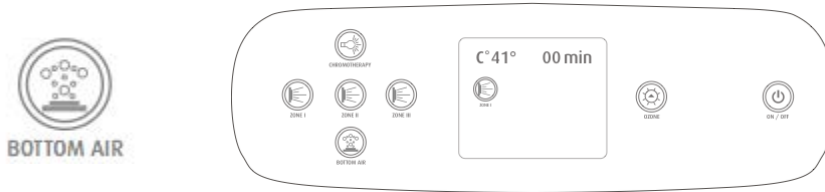

Chromotherapy

To activate the chromotherapy function, press on the **CHROMOTHERAPY** button on the Control Panel B.



Chromotherapy indicator will appear on the screen surrounded by a circle. (You will see LED lights going on).

Chromotherapy will automatically activate the first program – the soft shift between all of the colors present in the device.

You have the option to fix one specific color, in that case you have to press CHROMOTHERAPY button several times, until you see the desired color.

To turn the function off, press the **CHROMOTHERAPY** button.

Order of colors in the chromotherapy function:

1. Variable range of colors that are shifting softly
2. Red
3. Green
4. Blue
5. Yellow
6. Indigo
7. Orange
8. Violet
9. White

Ozone

To use the ozone function, press the **OZONE** button on control panel B and activate **ZONE I** (hold your finger for at least 2 seconds on the button). The ozone will activate automatically and the water circulation will mix in the water.

To turn the function off, press ZONE I and OZONE button.

Use ozone to clean the water from bacteria. Let the water circulate for 5 minutes before and after the treatments.



WARNING!

Do not use OZONE when client is in the bath!

Hand Shower

For the independent use of the hand shower, the hood of the cocoon must be opened and the client should be in a sitting position.

Hand shower must be connected by a special quick-connection - insert the end of the hose into the slot (water will start to flow).

Water temperature can be adjusted from the thermostat.

When you do not need to use hand shower any more, disconnect it from the quick-connection by pressing the ring down.

BLUETOOTH AUDIO

To use built-in Bluetooth audio, you can use your phone or any other transmitter device with Bluetooth support.

Here is the simple instruction how to pair your phone with built-in Bluetooth.

1. Please go to your phone settings and enter the Bluetooth section



2. Enable Bluetooth and start to search the device.



4. Click connect/pair to audio device.



Now your phone is paired with built-in Bluetooth and you can transmit your music from the phone to the Cocoon.

4

Treatments.

Therapies.

Effects.

Steam Sauna

Hippocrates, the founder of Western medicine more than two-thousand years ago said, "Give me the power to create a fever, and I shall cure any disease."

Although often misunderstood as a symptom of disease, fever actually is a part of the body's natural healing response. Steam baths, sauna, and other heat-inducing treatments elicit similar healing responses in the body, and consequently are often called "artificial fevers".

During a fever, the functioning of the immune system is stimulated, while the growth of bacteria and viruses is forced to slow down. The production of white blood cells, the primary agents of the immune system, is increased, as is the rate of their release into the blood stream. Apart from stimulating the immune system, the fever slows down the proliferation of invading organisms by creating an inhospitable environment, and is thought as one of the most effective and painless detoxifying treatments available.

According to the classical Ayurvedic texts, for maximal results, a steam bath should be taken with aromas of natural herbs and while keeping the head cool and the body supine. Just as it is in NeoQi® energy cocoons.

Heat speeds up the chemical processes in the body, making steam and sauna bathing one of the simplest and most comfortable

ways to rid the body of accumulated toxins. As the pores open up and the millions of sweat glands start to excrete, the body rids itself of metabolic and other waste products. Sweat contains almost the same elements as urine, and for this reason, the skin is sometimes called the third kidney. It is estimated that as much as 30% of bodily wastes are eliminated by way of perspiration. Last but not least, steam and sauna bathing produce powerful therapeutic effects simply by increasing circulation. As the carrier of the rebuilding forces of the nutrients to all parts of the body, the bloodstream plays a crucial role in the maintenance of health.

Steam and sauna treatments have a stimulating effect on the cardiovascular system. The pulse rate increases from 75 beats per minute to between 100-150 beats per minute during a 15-20 minute treatment. This increases blood circulation, but not blood pressure, since the heat also causes the tiny blood vessel in the skin to expand, accommodating the increased blood flow. The dilation of the capillary vessels enables the bloodstream to carry great amounts of nutrients to the skin, enhancing the nutritive status of the skin. The flushed, youthful look that steam and sauna bathers maintain for up to several hours after treatment is due to this effect.

In the hydrotherapeutic tradition used at European and America spas, sweat therapy is used in preparation for massage as a means of increasing the suppleness of the

muscles and creating a deep sense of relaxation in body and mind. In the Ayurvedic tradition of India, steam treatments are part of the traditional purification treatment panchakarma, where they are used after massage to help the body get rid of toxins dislodged during the treatment.

Sweat treatments can also be enjoyed on their own, as a workout for the cardiovascular system, a deep-cleansing treatment for the body, an immune system

booster, and a soothing and invigorating refreshment for the mind.

The steam temperature can be precisely adjusted to the preference of each client. The main thing to keep in mind is to enjoy the process. Do not push your body beyond its comfort level; the point is not to sweat it out the longest, but to allow your mind and body to luxuriate in this health-enhancing and invigorating miniature spa treatment with the help of NeoQi® energy cocoon.

Aromatherapy

Aromatherapy promotes the healing of the body and the improvement of the wellbeing through the use of 100% pure and natural essential oils derived from plants and herbs.

Aromatherapy affects the body in two ways:

- through the sense of smell (when inhaling aromas, they arouse brain receptor areas of the hypothalamus, which control the emotional sphere of a person);
- through penetration (active components of aroma oils, after passing transdermal barrier, enter the bloodstream and have a stimulating effect on the immune system).

Usage of specific compositions of essential oils can reduce appetite, relieve the symptoms of stress and fatigue, improve skin condition (increase its tone and elasticity, relieve inflammation from acne, stimulate the production of own structural proteins, etc.).

Essential oils are poured into the aroma dispenser and under steam sauna function

they activate and envelope the body with fragrant steam cloud.

Complexes of essential oils from NeoQi®:

1. Relaxation (sweet orange, grapefruit, marjoram, ylang-ylang)
2. Tonifying (rosemary, mint, orange, lemon).
3. Circulation (rosemary, mint, lavender, cypress)
4. Slimming (grapefruit, oregano, cypress, rosemary).

Storage of aromatic emulsions:

Complexes of essential oils should be stored in a cool, dark place to ensure their effectiveness.

Don't touch the aroma dispenser during the treatment and shortly after that, because of very hot surface.

Infrared Sauna

An Infrared Sauna is a device used to create radiant heat from a spectrum of light through a process called conversion. Infrared energy is measured in wavelengths called microns. The human body best absorbs infrared energy in the 3-50 micron range. The spectrum of infrared light used in an Infrared Sauna is 7-14 microns which is the same as the radiant heat emitted from the earth, but is only a small and highly beneficial segment of the light spectrum

emitted from the sun. The name means "below red" and comes from the Latin infra, "below", red being the color of visible light with the longest wavelength. The boundary between visible and infrared light is not precisely defined. The infrared segment of light occurs just below the visible level and has the ability to penetrate the body up to 3 inches where it converts into heat for deeper detoxification and other healing benefits.

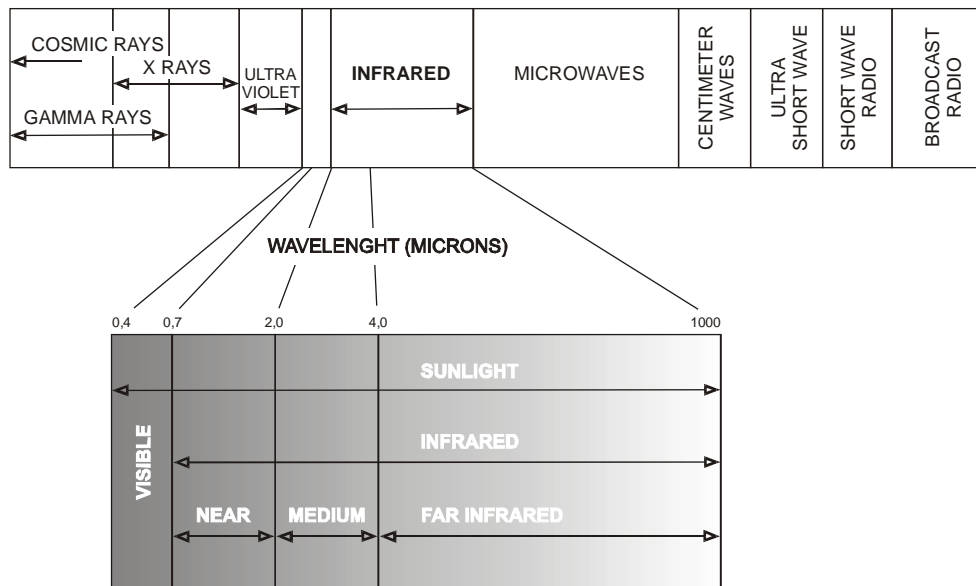

In a traditional sauna steam is generated by water being poured on a heated object, the ensuing steam heating the skin and the respiratory system. More recently, scientists discovered the healing benefits of far infrared light (electromagnetic radiation of a

wavelength longer than that of visible light, but shorter than that of radio waves) and infrared saunas were designed to use the infrared light to heat the body as opposed to steam.

One of the main differences between an infrared sauna and a traditional steam sauna is the temperature of the sauna. A steam sauna operates between 82°C and 104°C whereas the infrared sauna operates between 43°C and 65°C. This difference in temperature of up to 43°C has proven to be favorable to the infrared sauna as it drastically reduces the dangers of overheating. The greatest reward of the lower temperature is that a person can remain in the sauna longer and receive more of the healing benefits. The reduction in heat does not make the infrared sauna any less effective. In fact, it has been found that a person will sweat more toxins in a lower

temperature infrared sauna than a higher temperate steam sauna.

NeoQi® energy cocoon **operates at safe comfortable temperatures.** Infrared light penetrates the skin up to 10 times deeper than steam, which simply condenses on the skin and transfers the heat to its outer layers, whereas infrared light penetrates the body up to 2 inches where the light converts to radiant heat and exhibits far greater detoxification attributes. The deep penetration has many positive effects including: melting fatty acids, cholesterol and saturated fats which increases the elasticity of arteries and thus takes considerable stress off the heart.

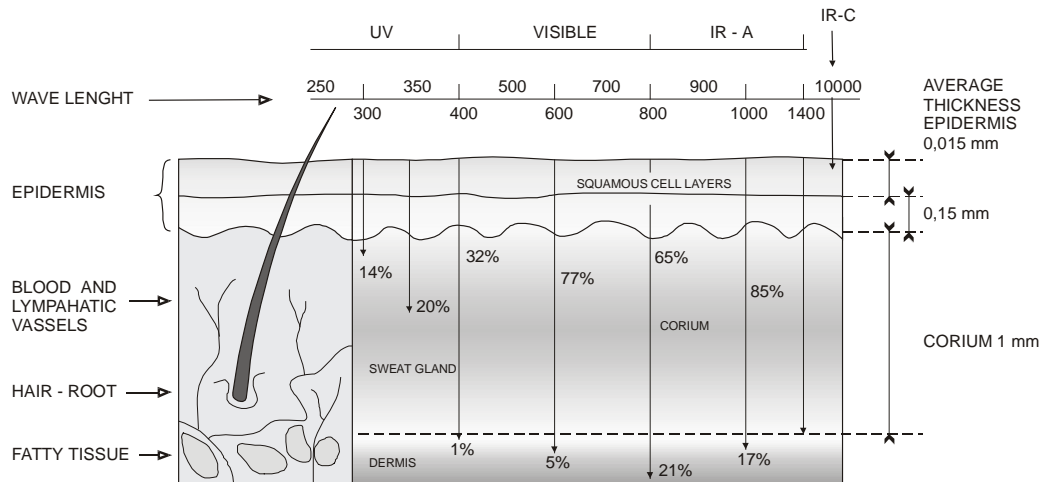

Infrared sauna has the ability to reduce inflammation in joints, help regenerate damaged tissues, stimulate the metabolism, and increase the core temperature which is beneficial to the immune system by weakening and killing cancer cells, bacteria, and viruses that are all susceptible to heat.

It is very important that one keeps thoroughly hydrated before and during the use of the Infrared Sauna. As the body heat increases and the body begins to sweat, the loss of water can change the electrolyte concentration and can have harmful effects. Furthermore, as the toxins are released through sweat, they are, to a lesser extent,

released into the body, so hydrating helps the body flush them out.

We currently live in a relatively toxic environment and have toxins stored in our fat cells. Many of the toxins include mercury, aluminum, formaldehyde, sulfuric acid, and more. When the infrared light penetrates the body and converts to heat, it has the ability to melt the fats holding the toxins and also activate the detoxification mechanisms which then purge the toxins through the skin. Sick or diseased cells and bacteria have a lowered resistance to heat. A fever is a natural way for the body to increase its temperature to kill off these cells. While in the Infrared Sauna, the body's temperature increases several degrees and further weakens these cells and bacteria. The heat also triggers the production of white blood cells and NK cells (Natural Killer) which then seek out these weakened cells and bacteria and kill them. The result is a strengthened immune system.

It has been shown in research that a 30 minute session in an Infrared Sauna will cause a person to burn 500-800 calories. This is equivalent to running 3-5 miles. Much of the weight that is lost directly in the sauna is water weight, which needs to be replenished with fresh water, but the calories that are burned will not be replenished with water and serve to increase the body's metabolism. This increase in metabolism has many effects that help weight loss, including increasing digestion function which efficiently converts the food you eat into energy.

Research has shown that the cardiovascular system is strengthened through repeated Infrared Sauna use. When the light penetrates the body and converts to heat,

the hypothalamus responds and increases the heart rate and volume. This is an effective means for cardio training and conditioning. The infrared light produces another effect which increases the cardiovascular function. When the body increases heat, the fatty acids and cholesterols melt. Many of these fatty acids and cholesterols are hardening the arteries and keeping them from expanding and contracting as required for proper circulation. This hardening of the arteries causes the heart to work harder at circulating the blood and when the fatty acids and cholesterols melt, it increases the elasticity of the hardened arteries which takes much of the burden off the heart and, therefore, decreasing the chance for heart failure.

The Infrared Sauna has many researched effects on the skin. Sebum is a waxy substance produced in the skin which can block pores and cause acne. Infrared light melts the sebum and unblocks the pores. Another effect the Infrared Sauna has is that it increases blood circulation to the skin which means that the body has the ability to deliver the necessary nutrients to the skin as well as remove the metabolic byproducts. The heat from the Infrared Sauna also has a detoxifying effect which purges the toxins from the skin as well as melts the cellulite trapped in pockets below the skin producing clean, smooth-looking skin. Finally, it helps healing damaged tissues which causes scars and keloids to be reduced. Some of the other effects on the skin are improvements of rashes, burns, eczema, and psoriasis.

There are some conditions that may be adversely affected by the use of an Infrared Sauna. If you have any of the following conditions, please consult with your

physician before use: Adrenal suppression, SLE (Systemic Lupus Erythematosus), Multiple Sclerosis, Hyperthyroidism, Hemophilia, acute joint injuries, enclosed infections (dental, joints, tissue), artificial joints, metal pins, or any other implants, or during menstrual cycle. Also, check with your physician or pharmacist for any

possible effects that infrared radiation may have on how the medication that you may be currently using interacts with the body. If, at any point during your session in the Infrared Sauna you stop sweating, your skin becomes clammy, you feel weak, tired or nauseous, LEAVE THE SAUNA IMMEDIATELY.

Hydrofusion

Hydrofusion is the blended energy of infrared heat and steam. This technology allows you to use both of these natural energies individually or simultaneously.

Together, these elements join forces to optimize body and skin cleansing, help rebalance skin moisture levels and promote the penetration of nutrients producing advanced skin care.

Steam and heat combined effectively (as in the NeoQi® cocoon) allow for the better absorption of nutrients in cosmetic products.

Hydrofusion is especially well compatible with thalassotherapy.

It is fact that the active interaction of steam and heat improves absorption and assimilation of active ingredients contained in clay, algae, mud and essential oils.

Thus, it is recommended to combine steam and infrared sauna in a single treatment for boosting the effect of treatment programs in the spa cocoon: for nourishing, hydrating, remineralizing and softening the skin, shaping body contours and treating cellulite, relaxation, anti-stress.

Advisable combinations....

Infrared+ steam/aroma sauna + vibromassage

It is possible to use the vibromassage function simultaneously with different sauna functions (see the "Instructions for using NeoQi® cocoon's vibromassage").

So-called "Vibrating sauna" is excellent for relaxation and performing an anti-stress treatment.

Infrared sauna and/or steam sauna + head massage

Adding the head massage to the sauna is very relaxing and is suitable for stress management. We also advise to perform

acupuncture if the therapist has gone through special training.

Body treatment in the sauna + face treatment and massage

NeoQi® energy cocoon has ergonomic design and easily opened see-through plastic face screen, which, even in closed position, allows a comfortable access to the client's head, neck and shoulders (upper part of the body). It allows carrying out

facial and body treatments simultaneously. You can combine all different sauna functions with the face treatment and the massage. It is reasonable to offer this combination as a treatment package or spa-treatment.

Vichy Shower

Vichy shower, resembling a heavy rain, provides gentle massage of reflex zones, improves blood circulation and lymph drainage, and has a positive effect on the nervous system.

Filiform Vichy shower (from the Latin filiformis - thread) – is a shower, in which a variety of warm and fine filamentary streams fall on your body in the form of rain.

The main results of the application of the Vichy shower are the detoxifying, sedative and tonifying effects. This is one of the best hydro-therapeutic massage treatments with a relaxing, anti-stress effect.

Vichy shower can be used for various purposes:

- body shaping,
- cellulite treatment

- normalization of metabolism,
- detoxification
- rejuvenation;
- relieving chronic diseases of the digestive system of the musculoskeletal system;
- improving thyroid dysfunction and other hormonal disorders;
- relieving constant stress, seasonal depression, fatigue and chronic fatigue syndrome;

With several water jets from 16 showerheads, varying temperatures, water pressure, spray pattern and spray angle the NeoQi® energy cocoon provides an invigorating hydrotherapy experience.

Vichy shower is perfectly combined with different types of body wraps, and body masks, especially with thalassotherapy products.

Vibromassage

Vibromassage uses mechanical vibration to prevent, treat, and promote recovery from a variety of physical ailments, including pain, sports injuries and bone density loss.

Increased blood circulation is a notable benefit of vibration, even at low intensity. As a result, cells receive more oxygen and nourishment. The body also develops better lymphatic drainage to improve overall health and immunity. It does this by taking away waste products and moving white blood cells to where they are needed. White blood cells are like the 'cavalry' of the body, removing debris from the broken down cells and attacking invading agents, such as poisons and bacteria.

Whole body vibration massage can help with the rehabilitation process of many injuries and procedures such as knee and hip replacements. Physiotherapists and chiropractors have found vibromassage to be an invaluable tool – having the ability to strengthen muscles without the usual strain on joints and ligaments. The process of rehabilitation involves an increase in blood flow, causing a dramatic spike in Human Growth Hormone – the key to regeneration and repair of soft tissue.

While improved circulation also helps to drain fluid build-up from injured tissue, vibration may stimulate a combined release

of hormones and natural chemicals to suppress pain.

The vibromassage feature of NeoQi® energy cocoon makes you experience

- immediate relaxation,
- relief from stress,
- soothing of aches and pains.

NeoQi® energy cocoon has a special vibrating table for performing vibromassage and to be used as a body treatment table.

NB! Vibromassage is absolutely contraindicated if the client has epilepsy, heart arrhythmia and heart stimulator.

You can regulate the low-frequency vibromassage waves from long, deep waveforms 10Hz level to rapid superficial 40 Hz level with +/- buttons.

Start every time at the lowest frequency.

Always take into consideration that the vibromassage frequencies need to be adjusted to the client's health condition, sensitivity and weight. Vibromassage doesn't have to inhibit speaking or to cause discomfort in the abdomen. Check the suitable level while having a conversation with the client. Clients with greater weight can use higher frequencies. Use lower frequencies if the client lies on the abdomen, compared to being on the back.

Advisable combinations....

Relaxing, recovering vibromassage

Vibromassage at 10-15Hz is relaxing, induces faster recovery and has a positive effect on different body systems.

This frequency level reduces pain, promotes lower muscle tones, a higher stable state, lower arterial pressure, more rapid oxidative processes, lowers emotional tension and ensures general calmness and anti-stress effect.

Vibromassage at 10-15 Hz is used before exercise therapy for reducing joint stiffness,

muscle tone and pain. The relaxing vibromassage helps to diminish complaints connected with workout after the exercise therapy.

Average length of relaxing vibromassage treatment is 20 minutes.

It is possible to combine vibromassage and sauna functions and active programs simultaneously as well as to perform a body wrapping treatment.

Tonic-type vibromassage

Higher frequency vibromassage, starting from 15 Hz, induces cell and tissue stimulation and vibration. It improves and stimulates the transfer of vital nutrients and waste products between the cells.

Frequencies at 15 – 35Hz are in use briefly from 5 to maximum 10 minutes for getting a toning effect. Client will be refreshed and vitalized.

Vibromassage acts as circulatory therapy. By improving circulation through the release of tissue activators and activation of zones, the vibromassage accelerates metabolic processes, functional and energetic performance potential of the skin, the muscles as well as the internal organs.

Tonic-type vibromassage is advisable to athletes as it increases readiness for the forthcoming activity and optimizes pre-competition condition. Every client needs a personal approach offering the relaxing or tonic-type vibromassage. It is necessary to repeatedly control frequency level and to regulate according to the condition of the client.

Generally the relaxing vibromassage is used to achieve the anti-stress and recovering effect. It is a part of SPA treatments.

When using the tonic-type vibromassage the therapist has to be all the time with the client to adjust frequencies adequately.

Hydrotherapy

The history of hydro therapy goes centuries back, as far as ancient Greece, but it was truly made popular by Romans, who introduced the benefits of bathing and massage to the countries they conquered. Roman public baths were always recognized as a great source of relaxation where members of high society and all free people alike could enjoy the benefits of hot and cold water as well as massage.

Hydro massage creates awareness of the body, reduces anxiety levels, gives a sense of well-being, improves the ability to monitor stress signals, gives a feeling of peace of mind, it also helps to alleviate discomfort caused by pregnancy, provides with a relaxed state of mental alertness, helps treat athletic or job related injuries, tension related headaches and post-operative rehabilitation.

The stimulating action of water and its absorption into the skin offers many benefits for:

- wellness,
- rehabilitation,
- stress reduction
- pampering

It's ideal for:

- muscular relaxation
- encouragement of circulation

- reduction of the increased release of stress hormones,
- creating an element of psychological and physical comfort.

The hydrotherapy bath is carefully and ergonomically contoured, it comfortably fits the body so that the pressure points are eliminated.

The bathtub is made of reinforced acrylics, especially tempered to provide heat and shock resistance. All surfaces are smooth and free of pores making the tub hygienic and easy to clean.

While performing the hydrotherapy it is important to take into consideration the client's health condition, age and the preceding procedures. The water temperature for regular whole body hydrotherapy procedure is 34-38°C, the length of one treatment is maximum 20 minutes.

Use the right program according to each client. The pressure of the water massage is softer if using water and air combined.

Hydrotherapy is ideal for:

- muscular relaxation, loosening and warming,
- encouraging circulation,
- easing pain by positioning the body in warm water and simultaneously using underwater massage,
- enhancing formation of endogenous hormones, reduction of the increased release of stress hormones,
- creating an element of psychological and physical comfort.

Chromotherapy

Chromotherapy is also known as color therapy. Color and light have been used for healing since the beginning of recorded history. Ancient Egyptians built solarium-type rooms with colored panes of glass. The sun would shine through the glass and flood the patient with color.

Some people use colored silk cloths, which are placed on the body and then flooded with sunlight. Early color and light healers in the modern world used colored gels and sheets of glass to apply light to the body. Others used color infused water and color meditations to send healing rays to the person.

Today, there are many practitioners who use color and light in interesting ways. Some therapists have a box with a mechanism that flickers light into the eyes. They report success in speeding the recovery of stroke victims and those persons who experience chronic depression.

Some healers recommend the wearing of eyeglasses with colored lenses. Practitioners of Feng Shui bring color into our homes and workplaces for optimum balance of energy.

The earth, the oceans, in fact every living thing, is dependent upon light for its very existence. A recent scientific study disclosed that each cell in the body emits light. We live in a sea of energy and our bodies are composed of energy. Color works through and in us, in every nerve, cell, gland and muscle. It shines in our auras and radiates upon us from the sun. Color is an active

power, exerting a tremendous influence on our consciousness, soul and spirit. Within our body, our organs, muscles, cells and nerves all have a level of vibration. When our body becomes out of balance, disease occurs. Each color has its own frequency and vibration. Through extensive research, we know that color and light will help bring our physical and emotional systems into balance.

High incidence diseases that can be treated with help of the chromotherapy:

- Emotional imbalances
- Stress
- Confusion
- Depression
- Low vitality
- Anxiety
- Insomnia
- Chronic fatigue
- Eczema
- Psoriasis
- Side effects of chemotherapy
- Menopausal problems

Chromotherapy uses six basic colors:

- **Red** – Known to escalate the body's metabolism with vibrancy and passion, overcome depression. Red color provides the power from the earth and gives energy on all levels. It connects us to our physical body.
- **Orange** – Has a gentle warming effect, increases immunity, potency. Best emotional stimulant!

- **Yellow** – Helps mental stimulation. Gives us clarity of thought, increases awareness, stimulates interest and curiosity.
- **Green** – Good for tired nerves, will balance emotions, refreshes the spirit, encourages us to feel compassion.
- **Blue** – Mentally-relaxing color, has pacifying effect on the nervous system and brings great relaxation.

Ideal for sleep problems and hyper-active children.

- **White** - White contains an equal balance of all the colors of the spectrum, representing both the positive and negative aspects of all colors. It offers an inner cleansing and purifying of your thoughts, emotions and, ultimately, your spirit, refreshing and strengthening your entire energy system.

Music therapy

Music therapy, one of the oldest and natural forms of correction of emotional states, is defined broadly as the use of music in the treatment of people who have problems of a mental, physical, and/or emotional nature. Music therapy was officially recognized in Europe in 19th century by leading doctors and nowadays it is still a vastly growing field of health care.

Music affects the body and mind in many powerful ways. It has a profound effect on our body and psyche, nevertheless, this therapy suits everyone regardless of age, health condition or musical abilities. It helps people with mental or physical disabilities, neurological problems, helps elderly to cope with acute and chronic diseases. In addition it relieves pain and reduces nervous tension.

Several studies have shown analgesic and relaxing properties of music therapy that has been used in treating chronic pain syndromes of different etiologies. There has been improvement in the process of rehabilitation: improved functional status and reduced pathological symptoms. Music has influence on the neuroendocrine function, in particular the level of hormones in the blood that play a crucial role in all emotional reactions.

Nowadays life tends to be very busy and therefore full of stress, against which music

therapy is a good preventive means as well as a supporting feature of everyday actions. Music has emotional and creative organizing qualities, which are used in medical communication, to facilitate contact, interaction, self-expression and self-development.

There are two forms of music therapy - passive and active. During passive music therapy patient is listening to various music according to the state of their mental health and the course of the treatment. While during active music sessions patients are involved in creating and performing music.

Four music pieces were composed specifically for treatments carried out in NeoQi equipment, by the Estonian music therapist Dali Kask, one of the most recognized experts in the field. This music accompaniment has a positive and magnifying impact on the perception of the treatment and can be combined with aromatherapy or breathing exercises.

Rhythmic components of music help to increase vitality. During music therapy a constant flow of energy passes within our body until the harmony is achieved. Music therapy leads a person to understanding and usage of the power of this harmony that seamlessly guides the process of achieving it.