

NEOQI®

Saltarium

ENG

Thank you for choosing NeoQi®

Main features in NeoQi® Saltarium

Privacy

A small slat cabin gives you a possibility to enjoy halotherapy beneficial effects undressed.



Buttons

You have only a few buttons to engender a salt mine surrounding effect for your body.



Ergonomic design

Every part of cocoon is made to suit with your special needs to relax.

The main functional possibilities of the NeoQi® Saltarium



Heating system

Is a simple to use function to have a comfortably warm base to lie on.



Music system

specially composed music accompaniment that has a positive impact the perception of the treatment.



Salt system

Is used to simulate the atmosphere of hydrochloric salt caves in your private salt cocoon.

Table of content

PRECONDITIONS. SET UP.

QUALITY REPORT	11
PRECONDITIONS FOR INSTALLATION	17
ELECTRIC CONNECTION	19
MAINTENANCE	20
OTHER TECHNICAL DETAILS	20
CLEANING THE SALT GENERATOR	21
TERMS OF WARRANTY	24
MARKINGS ON EQUIPMENT	26

INTRODUCTION. CAUTIONS.

INTRODUCTION	29
PHILOSOPHY OF NEOQi®	29
IMPORTANT CAUTIONS AND USER SAFETY INFORMATION	31
HEALTH PRECAUTIONS	32

GETTING STARTED. USING YOUR COCOON.

BASIC COMPONENTS OF YOUR COCOON	35
WARM-UP SESSION	36
USING SALT IN SALT GENERATOR	37
CONTROL PANEL OF HALOTHERAPY	38
1. SWITCH ON SALT GENERATOR	38
2. SET TREATMENT TIME	39
3. VENTILATION TIME AFTER THE END OF TREATMENT	39
4. START BUTTON	40
5. SALT FEEDER	41
6. BLOWING THE SALT AEROSOL	42
7. SPEED OF SALT MILL	43
8. STOP BUTTON	44
9. Bluetooth Stereo Headset	44

TREATMENTS. THERAPIES. AFFECTS.

HALOTHERAPY	49
MUSIC THERAPY	50

1

Preconditions.

Set up.

QUALITY REPORT

NeoQi Energy Cocoon

Serial Number:

—

Pre shipment inspection

Pre usage inspection

Date:

Physical aspects

body surfaces

components

technical condition

Functional test

control panels

Bluetooth Headphones

Heating system

Salt system

Checked by:

Before starting to use the unit, please fill out this form and mail it back to NeoQi AS.

Ph:+372 688 9100 Fax:+372 688 9101 Add: Piirimäe 15, Tännasilma, Saku vald 76406, Estonia

NeoQi AS
Piirimäe 15, Tännassilma
76406 Saku vald
Estonia
Ph. +372 688 9100

SERVICE REQUEST
DATE:
NUMBER:

DISTRIBUTOR'S NAME:

CUSTOMER'S NAME:

Equipent's Serial Number: **Saltarium:**

Date Equipment Received:

Date Equipment Delivered:

Date Equipment Started operating:

Date Problem Occurred:

Problem Report:

Person Reporting.....

NeoQi AS
Piirimäe 15, Tännassilma
76406 Saku vald
Estonia
Ph. +372 688 9100

SERVICE REQUEST
DATE:
NUMBER:

DISTRIBUTOR'S NAME:

CUSTOMER'S NAME:

Equipent's Serial Number:	Saltarium:
---------------------------	-------------------

Date Equipment Received:

Date Equipment Delivered:

Date Equipment Started operating:

Date Problem Occurred:

Problem Report:

Person Reporting.....



Preconditions for Installation

Room

Equipment is designed for use in indoor conditions.

Ventilation is recommended, as in the working regime the machine creates salt aerosol.

Doors must be wide at least 80 cm.

Power

Power cord material at least **3 x 2,5 mm²** copper crosscut.

Power cord should be connected into the moisture proof junction box which is located on the equipment frame.

Otherwise connect the plug to a socket, if the plug was already included in the equipment in the factory.

Maximum power consumption for equipment at a time is **0,3 kW**.

Protective device current in front of equipment feeder not less than **10mA**.

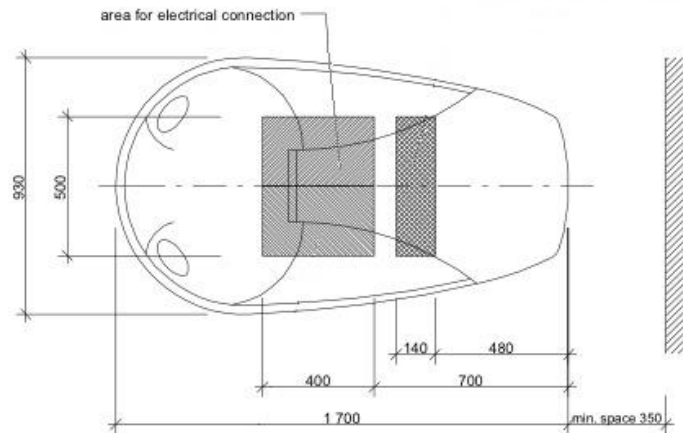

Legend for picture 1

Area for the main cable 3x2,5 mm² with free cable-end of minimum 2,0 m and the earth-connection cable 4mm² with free cable-end of minimum 2,0 m

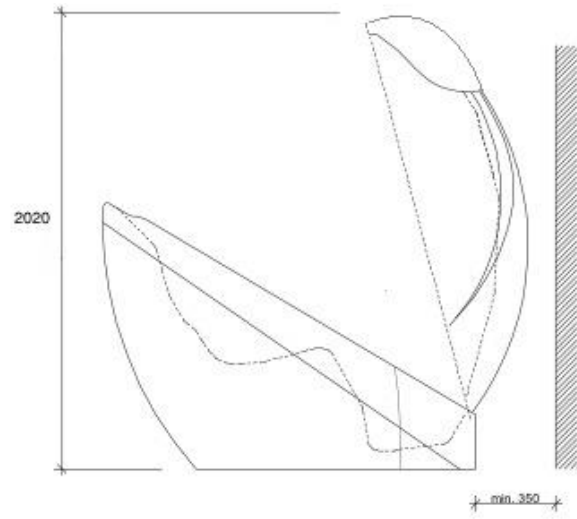
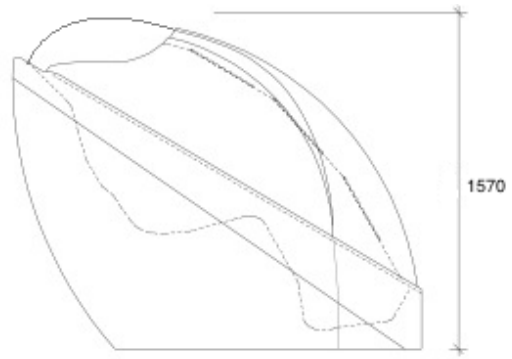

Electric Connection

Electric installations of NeoQi® equipment should be carried out by qualified specialists or official representative of NeoQi® AS.

NeoQi® Saltarium is CLASS 1 EQUIPMENT in which protection against electric shock does not rely on BASIC INSULATION only, but which includes an additional safety precaution, which implies that the EQUIPMENT must be connected to a protective earth conductor in a fixed wiring, in such a way that accessible metal parts cannot become live in the event of a failure of the basic insulation.

NeoQi® Saltarium belongs to the group of TYPE B EQUIPMENT, which provides a degree of protection against electric shock, which implies:

- allowable leakage current (10 mA);
- reliability of the protective earth connection.

NeoQi® Saltarium cannot be used if the air contains FLAMMABLE ANAESTHETIC MIXTURE WITH AIR or WITH OXYGEN OR NITROUS OXIDE.

Maintenance

Regular maintenance for certain parts is essential for long life and faultless functioning of the equipment. Routine maintenance ensuring safe operation includes cleaning, disinfection and visual control of general condition of the equipment.

Routine maintenance consists of cleaning the water system of the bath and the steam generator of the cocoon.

NB! Before using the equipment and composing the maintenance plan, the general quality and hardness of the water must be assessed.

In case of low quality water (high contents of limestone, iron, abrasive particles etc.), the installation of an appropriate water filter is required. The frequency of cleaning the steam generator is directly dependent on the hardness of water.

The warranty will be voided if maintenance is carried out non-systematically and only upon necessity.

Try to avoid scratching the acrylic surface with hard elements (sand, jewelry, accessories, etc.). Do not drop heavy and hard objects on the surface of the device.

Other Technical Details

The fuse rating utilized in the main external power supply circuit of stationary installed equipment:

Circuit breakers 20A

Used equipment cannot be transported or stored below 0 degrees C.

Cleaning the salt generator

You have to clean salt generator at the end of a day, if you have had a halotherapy session. Cleaned salt generator gives the best quality for salt aerosol. At the same time it is important for the salt generator lifetime.

Disconnect cable connection and take the whole salt generator out of the cocoon.

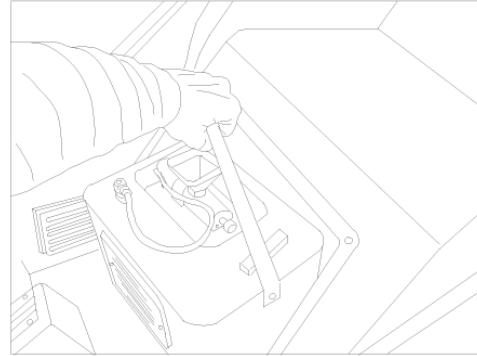

Disconnect cable connection and take a smaller part of salt generator into your hand. Pour out all the salt what is left into the bin of salt generator. You can use that salt on the next day as well. Just keep that salt at cool and dry place.

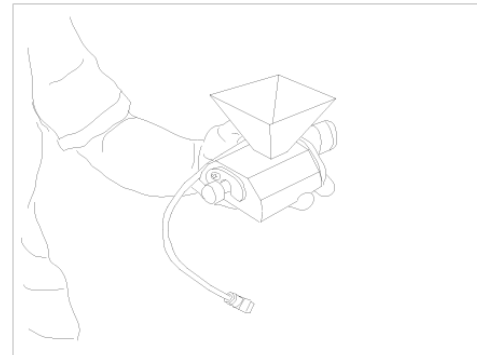

Pull up fixator of shaft. Now you can pull out the main part of salt feeder. Be careful, there are left some salt inside and do not let it fall on the floor.

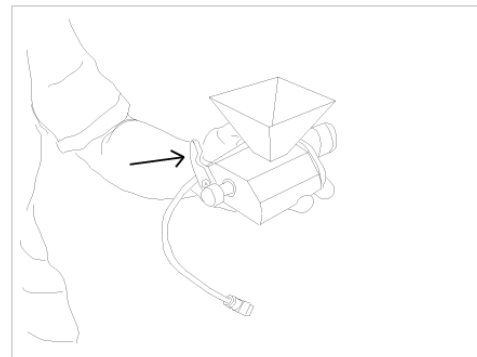

Pull out the shaft. Clean it with small brush from the salt remains. Look into the hole, where was shaft and remove salt from there too.

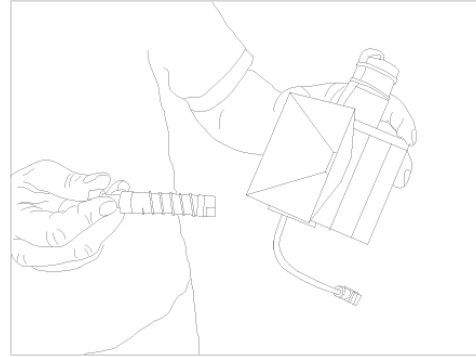

Be sure that all parts are cleaned and put smaller part of salt generator back together.

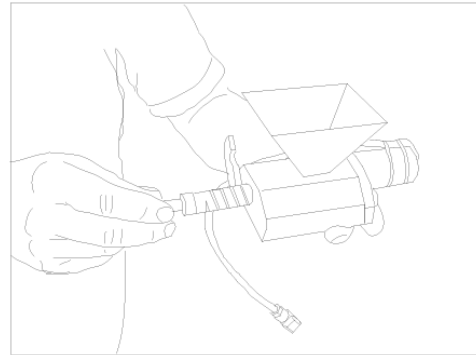

Once a week you should clean mill and its surrounding areas. At the same time be sure that the small vertical pipe is in the correct position. There is a hole on the shell of vertical pipe. This hole should be directed into the salt generator, it means that you cannot see that hole in vertical pipe if you look it from the outside.

Turn the bigger cover of the mill to the left. Now pull out the thin vertical pipe and remove lower part too, which one you just turned.

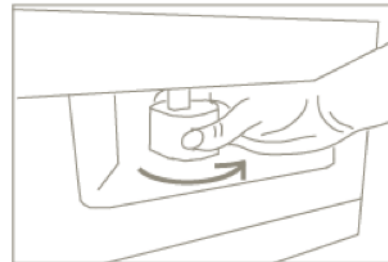

Now you can clean mill and its surrounding areas with soft pencil. Do that gently, otherwise you can harm paddles of mill.

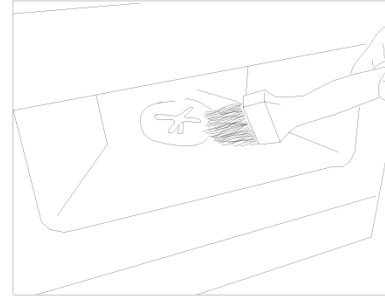

After cleaning put mill two plastic details back together and be sure that the hole in vertical pipe is directed into salt generator. Put smaller metal part back on the salt generator, connect cables and put whole salt generator into cocoon.

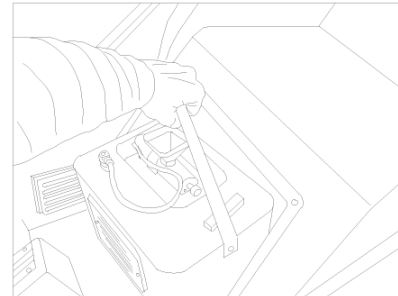

Cleaning the pipes

There will be eventual salt built-up at the base of the air circulation pipes in the cocoon behind the salt generator. To clean them, disconnect cable connection and take the whole salt generator out of the cocoon. Clean the pipe openings with a bottle brush cleaner and collect the salt with a vacuum cleaner. Put the generator back in place and connect the cable.

Terms of Warranty

NeoQi® energy cocoon is warranted to be free from defects in material or workmanship for parts and labor. The equipment warranty period is calculated from the date of issue of the commercial

invoice, for a period of 1 (one) year. The warranty for the spare parts, replaced during repairs under warranty, is valid until the end of the warranty period of the equipment itself.

- The basis for the warranty is a correctly filled warranty blank or a commercial invoice.
- The warranty applies only to the repair and replacement of defective components and does not apply to any other direct or indirect expenses or damage, caused by a defect or malfunction of the equipment.
- The warranty is valid if the equipment was regularly serviced (see service chapter in the user manual) and used according to the manufacturer's instructions as given in the user manual
- In the event of an unjustified service call, the transport charges are paid by the client.

The warranty does not apply in the following cases:

- In case the purchase documents are missing.
- Improper or negligent use of the equipment (see the service manual of the specific model); normal wear and tear; damage and defects, inflicted during an inappropriate connection of the equipment to the water and power supply, drainage and ventilation, as well as the installation of the equipment into the room
- Damage/malfunction, caused by the low quality of the water being used (for example limestone, abrasive particles, iron etc.)
- Mechanical damage (for example, infrared lamps), caused by improper handling while transporting and/or using the equipment
- Direct and/or indirect damages and/or expenses caused by voluntary/involuntary actions or inactions of the client (for example, not installing a water filter to achieve an adequate quality of water).
- A repair, disassembly and/or modification attempt carried out by unqualified personnel, other than qualified NeoQi® or its distributor representative.
- Causes independent of the manufacturer (vandalism, lightning, flood, fire, voltage surges and spikes, short circuit, freezing etc.)
- In case abrasive heavy-duty cleaning agents have been used, as well as substances that can chemically damage acrylic and polycarbonate parts.

The warranty does not apply to the following components and works

- Warranty works exclude:
 - o The cost of transport to the equipment/site.
 - o Elimination of damage to the equipment that has suffered from drainage, power and water supply breakdowns.
 - o Works related to clearing the space for a working area (0.5 meters around the equipment).
 - o Connecting necessary service lines to the equipment.
- Repairs of minor damage (for example, scratches), which do not influence the functionality of the equipment.
- Expendable materials (such as the steam generator, the quartz infrared tubes, filters, showerheads, pressure hoses etc.)
- Repairing damage inflicted by means of transportation not belonging to the manufacturer.
- Repairing damage caused by improper handling and/or storing by the customer.
- The cost of works and components related to the ordinary use and normal wear of the equipment:
 - o Regular cleaning of the steam generator, replacement of heating elements.
 - o Everyday maintenance, cleaning of the device.
 - o Replacement or cleaning of the drainage pipe.
- Eliminating defects and malfunctions caused by ignoring the installation requirements and user manual instructions.
- Equipment maintenance (cleaning, setting, servicing etc.) that are listed in the user manual.

Any other claims, in particular, claims for compensation for any damage not applicable to the appliance itself or that have arisen as a consequence of an excessively delayed repair work or replacement parts delivery, are not accepted.

Markings on Equipment

All products of NeoQi® comply with the requirements of the European Union.

1. CLASS

EQUIPMENT in which protection against electric shock does not rely on BASIC INSULATION only, but which includes an additional safety precaution. EQUIPMENT must be connected to the protective earth conductor in the fixed wiring of the installation in such a way that accessible metal parts cannot become live in the event of a failure of the basic insulation.

2. Type B

NeoQi® Harmony Mediq belongs to the group of TYPE B EQUIPMENT, which provides a degree of protection against electric shock, which implies:
allowable leakage current (10 mA);
reliability of the protective earth connection.

3. IPX5

According to the degree of protection against harmful ingress in the water the equipment provides protection against WATER JETS.
Marking is located on the bearing aluminum frame on the underside of the equipment.

4. Certificate of Conformity

The CE Marking indicates conformity of the equipment with Directive 2006/95/CE and 2004/108/CE



5. ATTENTION: Examine the attached documentation!

Marking located on the cover of the equipment

2

Introduction.

Cautions.

Introduction

Congratulations! You are now the owner of the newest addition and innovation of NeoQi® SPA equipment - the NeoQi Saltarium.

NeoQi® methods are inspired by ancient philosophy and life science, thanks to which NeoQi® energy cocoons allow you to restore the balance of your body.

NeoQi® energy cocoons offer a wide variety of therapeutic treatments that are suitable for different personal needs and are tailored to resolve specific problem encountered by each client. NeoQi® energy cocoons respond to new demands on the market by combining treatments with a total wellness approach.

NeoQi® treatments are aimed at providing all around holistic treatment. This method does not only address beauty, but also well-being and complete body relaxation. It is inspired by energy treatments that eliminate muscular and vascular tension and release vital energies (circulatory, drainage, nutritive).

Beneficial effects:

...for airways disorders

- Prevention and treatment of common cold
- Clean airways from pollutant and tobacco smoke particles
- Allergies with an effect on ear, nose, throat, sinuses (e.g. hay fever)
- Asthma, chronic obstructive pulmonary diseases, pneumonia, bronchitis, cystic fibrosis
- ENT-diseases (rhinitis, sinusitis, pharyngitis, laryngitis)

...for skin disorders

- Acne
- Neurodermatitis
- Psoriasis
- Cellulite

...for mental condition

- Chronic fatigue
- Overstrain and exhaustion
- Depression
- Stress
- Quit tobacco smoking

NeoQi® cocoon features in one piece of equipment the following unique combination of functions:

- Halotherapy
- Back heating system
- Music System

NeoQi® energy cocoons promote rejuvenation, longevity and all around wellbeing. The therapies are suitable for men and women, of all ages and fitness levels.

NeoQi® energy cocoons have been developed with the highest criteria concerning quality and safety. Use this product only for its intended use as described in the current manual. NeoQi® Harmony Mediq equipment must be used in accordance with the operating instructions.

In order for us to provide better service, please record the model and serial number in the space provided below. The number can be found on the backside of the equipment cover. Kindly provide these numbers whenever you call to the customer service or contact your dealer.

Philosophy of NeoQi®

The invisible life energy - **Qi** flows through everything in life. It is the vitality, breath, and essential animating life force of the universe.

The free energy flow will make you feel vibrant, stay fit and healthy - both mentally and physically. You feel invigorated in every moment of your life.

However, if the energy becomes stagnant or blocked, erratic and undisciplined (due to an unhealthy lifestyle or weakness in an interior organ) you will most likely fall ill. Blocked or inhibited Qi causes dysfunction in the body's internal organ systems.

We humans are able to detect imbalances in ourselves and take steps to redress them - without the need to seek professional help. This will become the ultimate form of preventative medicine, gently healing emotional trauma. We will be able to uncover the psycho-spiritual traumas, which underlie much of modern illnesses, before they become a physiological problem.

NeoQi® therapies help you to replenish and free the circulation of Qi, restore health and to find new life energy. Each session produces sensations and feelings of well-being, relaxation and calmness. Mental fitness is improved through reduction of stress.

NeoQi® energy cocoons also benefit healthy people, being a powerful tool for preventative medicine, allowing to maintain health, as well as improve it.

NeoQi® energy cocoons - the unique sensation you can experience in your own privacy, in a safe, comfortable, calming environment.

NeoQi® helps you maintain your inner balance.

Understanding and accepting the energy will become natural part of our everyday life. Once you can sense vital energy, you can begin to work with it - helping to move it in the most beneficial way.

The energy secret lies in exploring and enhancing your physical, emotional and spiritual energy.

As our lives become ever more demanding, we all have to make the choice. We can turn our backs on the energy equation and just get by, or we can tap into the infinite possibilities of the energy and start to live our lives on a whole new dimension.

NeoQi® treatments offer a step towards the understanding of the energy concept.

Choosing to live with the knowledge of energy concept is to tap into an endless source of personal power and joy.

It is a lifestyle choice of the new millennium - affecting every area of daily life in the deepest possible way.

Important Cautions and User Safety Information

When operating this system, the following procedures must always be followed:

IMPORTANT: Read carefully the Section 2 of this manual - "General Instructions and Health Precautions" - to avoid any health risk or adverse effects of using the cocoon!



WARNING:

Do not stay in a high temperature sauna or in a very hot bath for too long. First time users should get accustomed to the system, prior to experiencing longer sessions.

For hygienic reasons, all bathers should shower and thoroughly wash their body prior to use of the system.

To reduce the risk of injury, do not allow children, the elderly or mentally/physically challenged persons to use this system without close supervision by qualified personnel at all times.

Safety, reliability and performance of the NeoQi® equipment can be guaranteed only if:

The installation and other actions, including modifications and repairs are performed by qualified specialists or official representatives of NeoQi® AS.

The installation is carried out in accordance with the applicable rules and regulations listed in the part "Preconditions for installation" of the current manual.

Do not use the equipment if the power cord is damaged, if it is not functioning properly, if it has been dropped or damaged. Contact NeoQi® AS service center for inspection and repair.

Avoid the contact of the power cord with hot surfaces.

Use only clean tap water.

Do not insert any objects into the openings of the equipment.

Prolonged immersion in a hot sauna or bath might induce hyperthermia.

Individuals in a state of alcohol or drug intoxication are forbidden from using the system, as it significantly increases the risk of fatal hypothermia.

People with an adverse medical history or using medication should consult their physician before using this system.

Pregnant or possibly pregnant women should consult their physician before using this system.

Health Precautions

Treatments in NeoQi® energy cocoon are contraindicated in the below mentioned cases:

- Acute stage of respiratory diseases
- Chronic obstructive lung diseases with the 3rd stage of chronic lung insufficiency
- Intoxication
- Cardiac insufficiency
- Bleeding
- Spitting of blood
- Hypertension in IIB stage
- All internal diseases in decompensation

Also, there are the following contraindications:

- tuberculosis in an active stage
- malignancies
- bleeding tendency
- All blood diseases
- broncho-pulmonary diseases (acute period, high fever, intoxication)
- claustrophobia
- sexually transmitted diseases in the acute form
- mental illness

- pregnancy at all stages;
- the period of exacerbation of chronic diseases
- chronic alcoholism and drug addiction

Please consult with your physician whenever uncertain about any condition or response.

!! Should any condition get worse, stop using the NeoQi® cocoon immediately.

Cancer: Treatments for clients with cancer should be carried out with caution. It is strongly recommended that you work with a client only with the consent of his physician.

Weakness: Heat therapy may be contraindicated for a client who is feeling weakness as a treatment may worsen the condition.

!! Do not attempt to treat any disease independently with the NeoQi® energy cocoon infrared sauna without supervision or without the help of a certified physician.

3

**Getting Started.
Using Your Cocoon.**

Basic Components of Your Cocoon

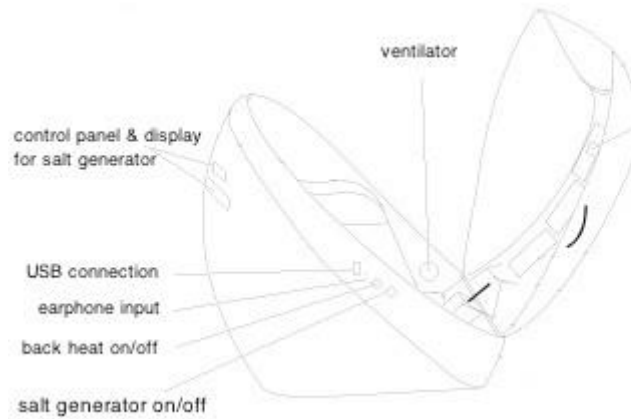

NeoQi® cocoon sounds are operated by Bluetooth stereo headset.

NeoQi cocoon salt generator is operated by control panel what is located on the backside of the cocoon.

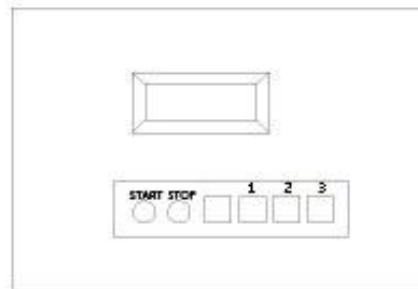

Warm-up Session

Before the treatment:

First switch ON the back heating system, 15 minutes before the treatment. ON/OFF button is located on the side of cocoon. When heating system starts to work, small light indicator will start to shine.

By warming up the sitting area, you ensure extreme comfort at the maximum level for the client from the beginning of the treatment.

IMPORTANT: All functions of the device can be switched off by pressing the ON/OFF button.

Client must be informed of the location and operation of the ON/OFF button prior to activating any functions!!

Consider specific needs of your client and confirm the plan of the treatment session with the client.

For hygienic reasons do clean all acrylic surfaces should be cleaned with appropriate cleaning product before and after each client.

During the treatment:

Following warm-up cycle the cocoon hood can be opened and the client can sit in to

cocoon. The cocoon cover should be closed slowly and carefully.

IMPORTANT: Safety precautions must be followed when sitting inside the cocoon, especially when opening and closing cocoon hood:

Energy cocoon should be operated at all times either in fully opened (hood is resting fully back against the hinge stops) or fully closed position.

Once the client is comfortably positioned in the cocoon, cocoon hood can be slowly and carefully lowered, making sure that the head, arms and legs of the client completely fit within the energy cocoon. Never leave the cocoon hood in a partially open or closed position!

Please make sure that your client is comfortable during the treatment, if necessary, adjust the temperature.

We strongly recommend that you start with smaller salt concentration and after the body gets used to the treatment, salt concentration can be increased.

After the treatment:

After the treatment, offer your customers refreshments 2clean water or herbal tea.
IMPORTANT: All functions should be turned off after the treatment!

Using Salt In Salt Generator

You have to use a salt, which is 100% dry. If you are not sure about it, then heat your salt up to 50 degrees of Celsius for 30 minutes.

Use 75 to 100 g of salt for the one session. Salt what is left in bin, can be used on the

next time as well. Now, pour salt into bin, what is located at the top of salt generator. Put generator into cocoon and connect power supply cables. Now is all ready to change settings for the halotherapy.

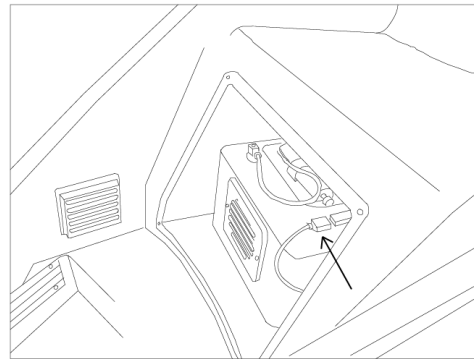
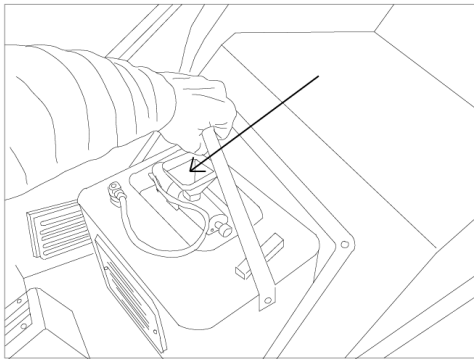

Control Panel of Halotherapy

NB! Halotherapy should only be taken while sitting inside the cocoon with closed hood!

A quick overview of operation:

1. Switch on salt generator from the side of cocoon.
2. Hold your finger on the button **MENU**. Set treatment time.
3. Hold your finger on the button **1**. Set ventilation time after the end of treatment.
4. Press on button **START**.
5. Hold your finger on button **MENU**. Set speed of salt feeder.
6. Hold your finger on button **1**. Set speed of blowing the salt aerosol.
7. Hold your finger on buttons **MENU** and **1**. Set speed of salt mill.
8. Press on button **STOP**. Parameters are saved.

Now you can start to use halotherapy. Pour salt into the bin and press on button **START**.

1. Switch on Salt Generator

Press on the main button on the side of cocoon. Now you can see display on the backside is starting to show numbers. It means salt generator is ready to work and you have to set parameters for halotherapy. If you wish to use the same settings as previous session had, then just press on button **START** and halotherapy is starting to work as the previous session.

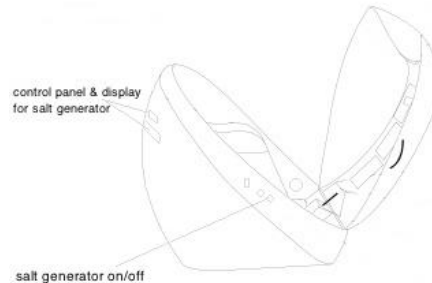

2. Set Treatment Time

If you have switched on the salt generator from main on/off button on the side of cocoon, then you can set treatment time. Hold your finger on the button **MENU**. On the screen you will see **P**. That means you can start to change treatment session time.

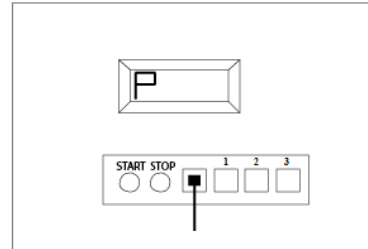

If you wish to reduce treatment time, then press on button **2**. You will see how numbers are decreasing. All timers are operating in minutes. If you are changing time, do not forget to hold your finger at the same time on button **MENU**.

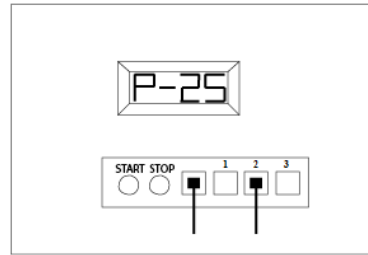

If you wish to increase treatment time, then press on button **3**. You will see how numbers are accruing. All timers are operating in minutes. If you are changing time, do not forget to hold your finger at the same time on button **MENU**.

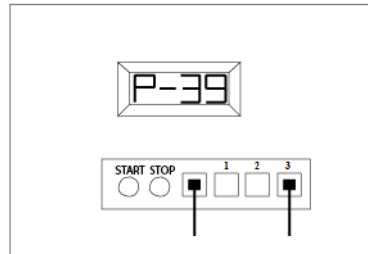

3. Ventilation Time After the End of Treatment

Ventilation after the treatment is important to reduce salt concentration in cocoon. If client comes out from the cocoon after ventilation session then there is a less salt in

the air, what can be spread into the environment of room.

Hold your finger on button **1**. On the screen you will see **A**. That means you can start to change ventilation timer. It activates after the end of treatment session.

If you wish to reduce ventilation time, then press on button **2**. You will see how numbers are decreasing. All timers are operating in minutes. If you are changing time, do not forget to hold your finger at the same time on button **1**.

If you wish to increase ventilation time, then press on button **3**. You will see how numbers are accruing. All timers are operating in minutes. If you are changing time, do not forget to hold your finger at the same time on button **1**.

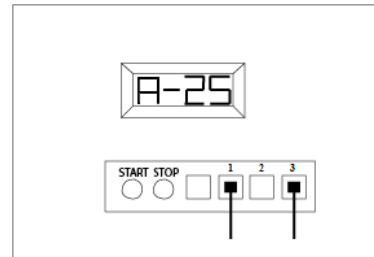
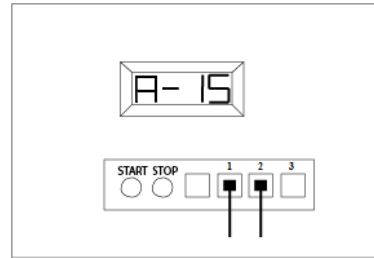
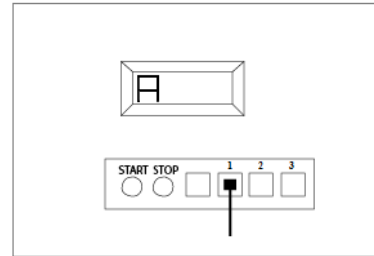

4. Start Button

START activates salt generator feeder, ventilator to blow salt aerosol and salt mill. If START is activated, then you can see on the screen how minutes are decreasing to the end.

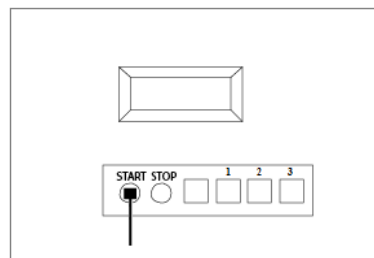

5. Salt Feeder

Salt feeder gives salt to mill. From the salt feeder option you can set how big dose of salt will be made into salt aerosol.

If you have pressed on button **START**, then you can change doses. Hold your finger on button **MENU**. On the screen you will see **d**. That means you can start to change feeder doses.

If you wish to reduce doses, then press on button **2**. You will see how numbers are decreasing. Doses are between levels 1 - 5. If you are changing doses, do not forget to hold your finger at the same time on button **MENU**.

If you wish to increase doses, then press on button **3**. You will see how numbers are accruing. Doses are between levels 1 - 5. If you are changing doses, do not forget to hold your finger at the same time on button **1**.

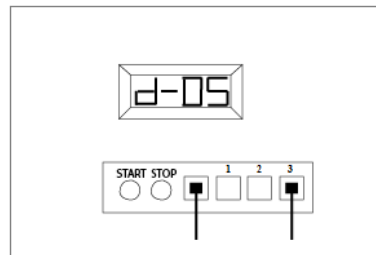
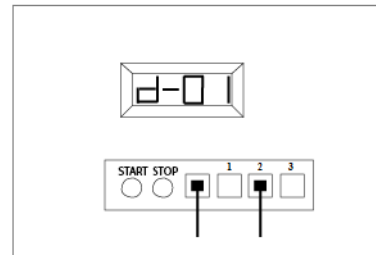
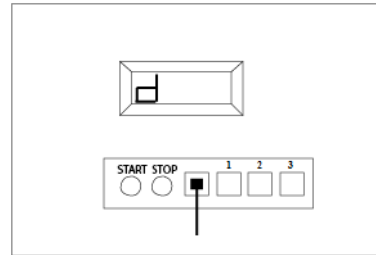

6. Blowing the Salt Aerosol

Blower for salt aerosol is circulating salt aerosol in cocoon atmosphere. From the blower option you can set how fast aerosol concentrate is growing and how quickly aerosol is circulating.

If you have pressed on button **START**, then you can change blower settings. Hold your finger on button **1**. On the screen you will see **F**. That means you can start to change blower speed.

If you wish to reduce blower speed, then press on button **2**. You will see how numbers are decreasing. Speeds are between levels 1 - 5. If you are changing speed, do not forget to hold your finger at the same time on button **MENU**.

If you wish to increase blower speed, then press on button **3**. You will see how numbers are accruing. Speeds are between levels 1 - 5. If you are changing speed, do not forget to hold your finger at the same time on button **1**.

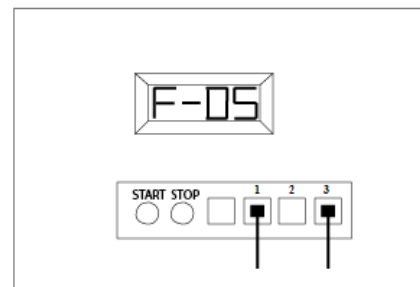
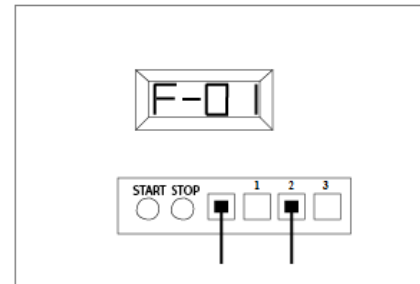
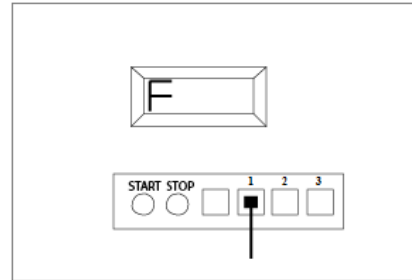

7. Speed of Salt Mill

Speed for salt mill controls size of salt particles. From the mill option you can set how big particles are circulating in atmosphere of cocoon. Higher speed of mill burst salt particles to smaller pieces.

If you have pressed on button **START**, then you can change blower settings. Hold your finger on buttons **MENU & 1**. On the screen you will see **E**. That means you can start to change mill speed.

If you wish to reduce mill speed, then press on button **2**. You will see how numbers are decreasing. Speeds are between levels 1 - 5. If you are changing speed, do not forget to hold your finger at the same time on buttons **MENU & 1**.

If you wish to increase mill speed, then press on button **3**. You will see how numbers are accruing. Speeds are between levels 1 - 5. If you are changing speed, do not forget to hold your finger at the same time on button **MENU & 1**.

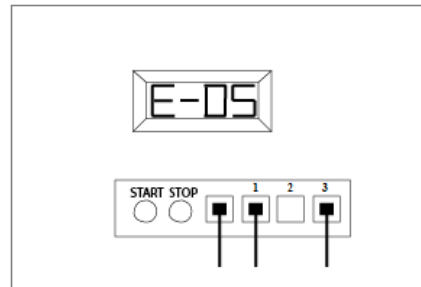
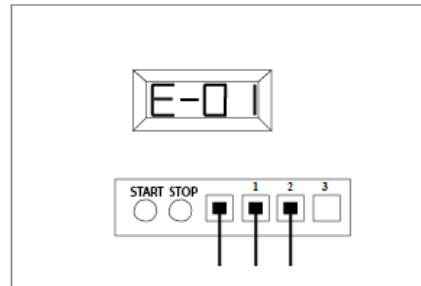
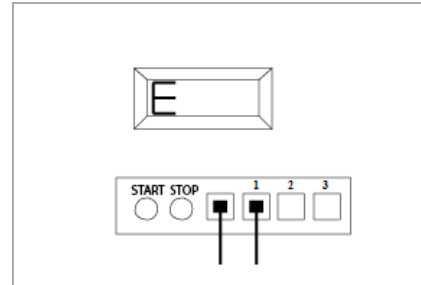

8. Stop Button

If you press on button STOP then whole salt generator stops working. But it still has a power supply and is switched ON.

If you press on button STOP, then halotherapy session is back in the beginning, where you can start to set session timing and so on.

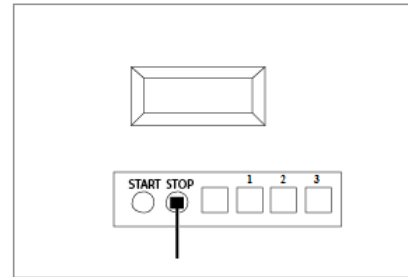

Bluetooth Stereo Headset NX-8252

BUTTON, INTERFACE, SWITCH

ON/OFF	Power on / off	Stop or start the system
M	Connect / Hang Up	Control calls action
▶ 	Pause / Play	Control music action
+	Skip track / Volume+	Short press: skip track forward / Long press: increase volume
—	Previous track / Volume-	Short press: rewind to previous track / Long press: decrease volume
I/O	Audio I/O Interface	External device audio input earphone speaker, headphone audio output to external speakers
USB	Charging	Connect the charger USB charge

Charging the battery with a USB cable

Before charging, power off the headset. Using the charging cable connect the headset to the computer USB. The Indicator Light will then turn bright red. This shows the headset is charging.

The headset has a built-in battery capacity detection system with overload protection, so over-charging will not have an impact on the battery. When the light goes off, charging is complete.

- Low battery - When power is low, the multi-coloured lights flash. Charge as soon as possible.
- Note: Do not remove cable from headset until charging is complete to avoid damage to the headset hardware and battery life.

Usage steps:

- Push On/Off switch. The headset will automatically search for a Bluetooth connection. This is shown with an indicator light, which flashes blue and red alternately.
- Make sure your Bluetooth device is switched on.
- Open your device's Bluetooth options and select NX-8252. Once paired successfully, the headset indicator light will flash green. Note: it may ask the password (0000)
- If the pairing is unsuccessful, please switch off headset, and try the previous step again.
- After successfully pairing the devices, the connection will be remembered, unless a new pairing has been made.
- The Headset has Multilink technology, which allows simultaneous connection between two different devices, simply repeat the pairing process on both devices.

>Re-connecting to a Bluetooth device

Automatic connecting:- Every time the headset is switched on, it will connect to the nearest and most recent connected device automatically.

>Manual connection to last connected device:- If the headset doesn't connect to any device and remains on standby, press MFB button once and it will connect to last connected device automatically.

Music on the USB stick:

Song nr 1

This music will take you on a little journey into the wild and is built upon sounds of nature. The half an hour long promenade begins by the sea, continues through the forest and then returns you to the seaside again. The walk is accompanied by the sounds of the sea, birdsong and the humming of the bees.

The sounds of nature allow you to break away from the daily bustle of the city, providing a complete rest.

Song nr 2

This song is based on the sounds of Estonian nature, accompanied by different musical sounds. The promenade begins by the sea, continues through the forest and then returns you to the seaside again. The melody, combined with natural sounds has an exhilarating influence. The predetermined pace of the music allows you to dissolve in time and fully relax.

Song nr 3

This New Age style music with a calm pace is based on various musical shapes. The music's tempo - 60 beats per minute, corresponds to the human heartbeat at rest. The soft and soothing sound of the music will allow the listener to free himself from physical tension, stress, slow down thoughts his and relax.

Song nr 4

This dynamic music program is in the style of New Age. An interesting-sounding musical shapes and changing harmony affects the listener in exhilarating ways, filling with new energy.

4

Treatments.

Therapies.

Affects.

Halotherapy

The term “Halotherapy” comes from “halo”, the Greek word for salt. Simply put, Halotherapy is the use of salt vapor to treat respiratory ailments, skin irritations, and combat mental lethargy.

For centuries, monks used naturally-occurring salt caverns to treat respiratory ailments. Today, manmade Saltrooms recreate salt caverns, with one huge improvement over nature: in a Halotherapy room, a salt vaporizer pumps dry aerosol salt vapor into the air, so you can breathe it deep into your lungs.

Salt is known to be:

- anti-bacterial
- mucolytic (loosens mucus & phlegm)
- anti-inflammatory

Breathing salt vapor takes the healing properties of salt deep into the respiratory system, which explains why salt miners have always been so healthy!

More than 40 years of research, conducted around the world, shows that treatment with Halotherapy has beneficial effects for patients with:

- Asthma
- Chronic Bronchitis
- Sinusitis

- COPD (Chronic Obstructive Pulmonary Disease)
- Cystic Fibrosis
- Allergic Rhinopathy or Hay Fever
- Ear Infections
- Various acute or chronic respiratory diseases
- Smoker’s cough
- Viral infections
- Coughs and colds
- Chronic ear-nose-throat illnesses

Salt is also extremely beneficial to your skin in treating:

- Acne
- Psoriasis
- Neurodermatitis
- Eczema

In addition, salt naturally produces negative ions, which produce the “clarity effect” that people love from Halotherapy treatments. Negative ions have been shown to reduce:

- Stress
- Headaches
- Lethargy
- Depression

And negative ions can dramatically increase your:

- Energy
- Mental alertness
- Overall sense of well-being

Music therapy

Music therapy, one of the oldest and natural forms of correction of emotional states, is defined broadly as the use of music in the treatment of people who have problems of a mental, physical, and/or emotional nature. Music therapy was officially recognized in Europe in 19th century by leading doctors and nowadays it is still a vastly growing field of health care.

Music affects the body and mind in many powerful ways. It has a profound effect on our body and psyche, nevertheless, this therapy suites everyone regardless of age, health condition or musical abilities. It helps people with mental or physical disabilities, neurological problems, helps elderly to cope with acute and chronic diseases. In addition it relieves pain and reduces nervous tension.

Several studies have shown analgesic and relaxing properties of music therapy that has been used in treating chronic pain syndromes of different etiologies. There has been improvement in the process of rehabilitation: improved functional status and reduced pathological symptoms. Music has influence on the neuroendocrine function, in particular the level of hormones in the blood that play a crucial role in all emotional reactions.

Nowadays life tends to be very busy and therefore full of stress, against which music therapy is a good preventive means as well

as a supporting feature of everyday actions. Music has emotional and creative organizing qualities, which are used in medical communication, to facilitate contact, interaction, self-expression and self-development.

There are two forms of music therapy - passive and active. During passive music therapy patient is listening to various music according to the state of their mental health and the course of the treatment. While during active music sessions patients are involved in creating and performing music.

Four music pieces were composed specifically for treatments carried out in NeoQi equipment, by the Estonian music therapist Dali Kask, one of the most recognized experts in the field. This music accompaniment has a positive and magnifying impact on the perception of the treatment and can be combined with aromatherapy or breathing exercises.

Rhythmic components of music help to increase vitality. During music therapy a constant flow of energy passes within our body until the harmony is achieved. Music therapy leads a person to understanding and usage of the power of this harmony that seamlessly guides the process of achieving it.