

**DAIKIN**

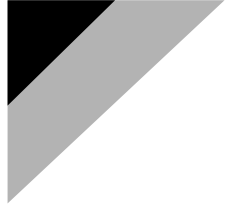

# OPERATION MANUAL

## **VRV III** Outdoor - Air Processing Unit

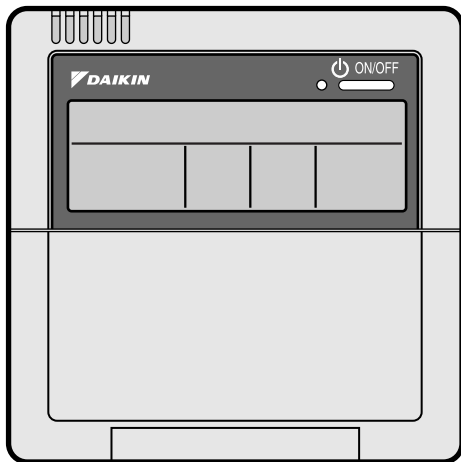

**FXMQ48MFVJU**  
**FXMQ72MFVJU**  
**FXMQ96MFVJU**

**Operation manual**  
**VRVIII Outdoor-air processing unit**

English

**Manuel d'utilisation**  
**Unité de renouvellement d'air VRVIII**

Français

**Manual de operación**  
**Unidad de renovación del aire VRVIII**

Español

Thank you for purchasing Daikin products. Carefully read this operation manual before using the unit. It will tell you how to use the unit properly and help you if any trouble occurs. After reading the manual, file it away for future reference.

Nous vous remercions pour avoir choisi les produits Daikin. Lisez attentivement ce manuel d'utilisation avant d'utiliser l'unité. Il vous enseignera à utiliser correctement l'unité et vous aidera en cas de panne. Après avoir lu le manuel, rangez-le en vue d'une utilisation ultérieure.

Muchas gracias por comprar productos Daikin. Lea este manual de uso atentamente antes de utilizar la unidad. El manual explica cómo usar la unidad correctamente y lo ayuda en caso de que surjan problemas. Después de leerlo, guárdelo para referencia futura.

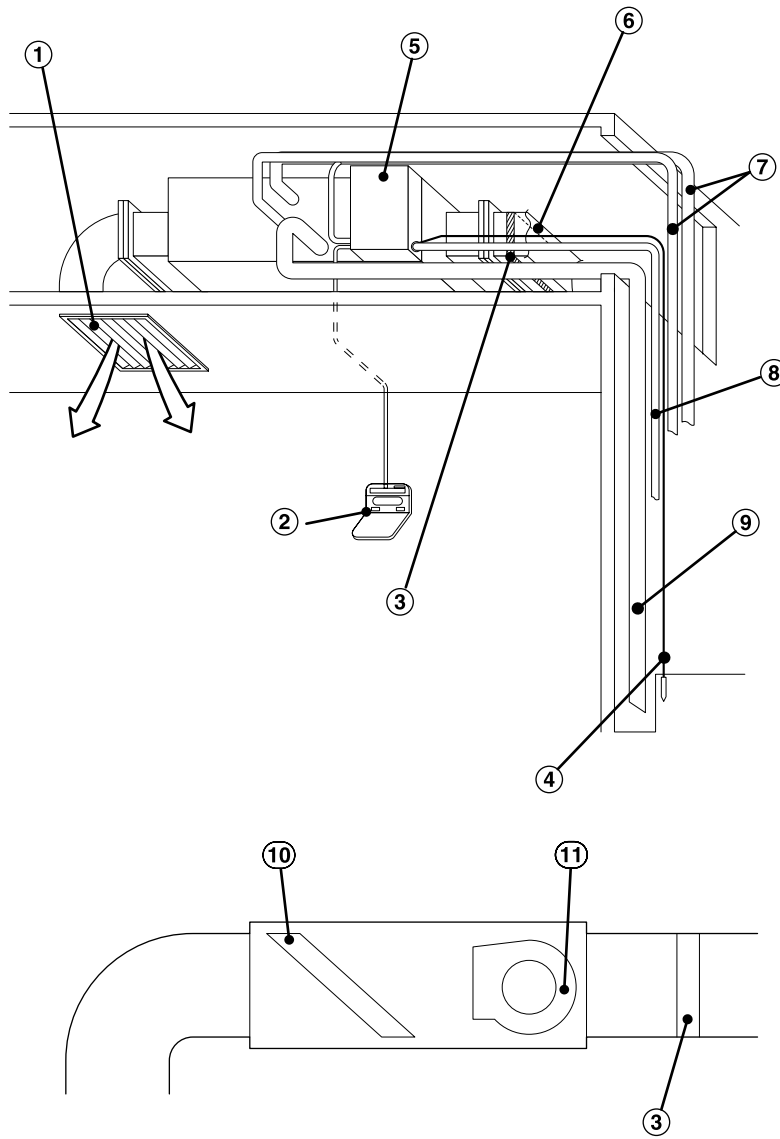

1

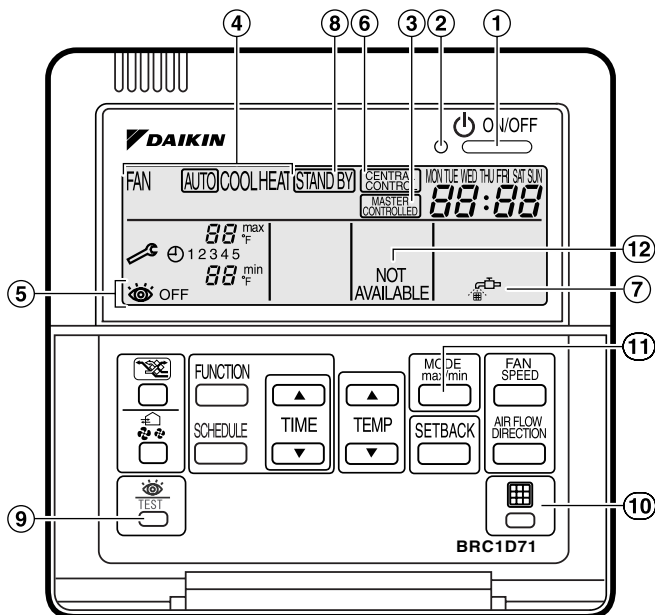

2

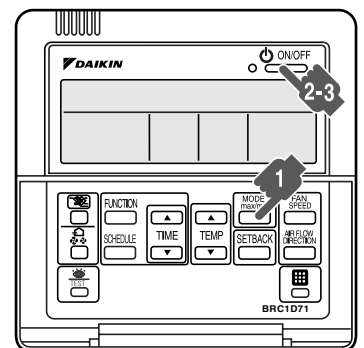

3

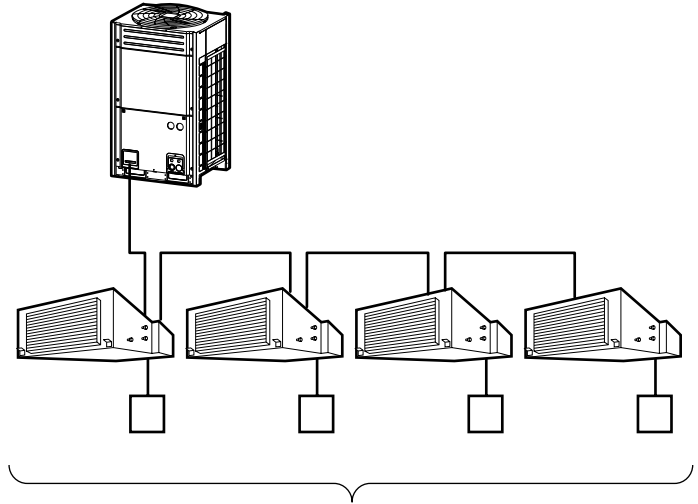
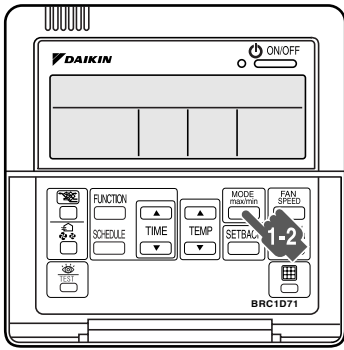

Outdoor-Air processing unit

4

5

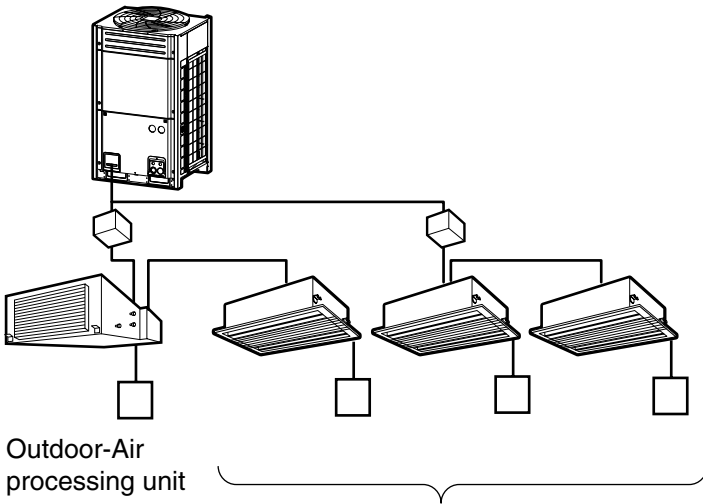

Outdoor-Air processing unit

Indoor unit for room air conditioning

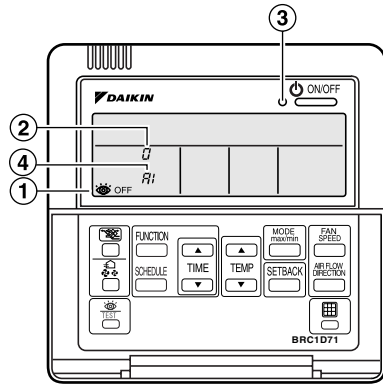

6

7

# CONTENTS





1. SAFETY CONSIDERATIONS.....	1
2. OUTDOOR-AIR PROCESSING UNIT : NAME OF EACH PART (Refer to figure 1) .....	3
3. REMOTE CONTROLLER : NAME AND FUNCTION OF EACH SWITCH AND DISPLAY (Refer to figure 2) .....	4
4. OPERATION RANGE .....	4
5. OPERATION PROCEDURE .....	5
6. OPTIMUM OPERATION.....	6
7. MAINTENANCE .....	7
8. FOLLOWING SYMPTOMS ARE NOT SYSTEM TROUBLES .....	7
9. TROUBLE SHOOTING.....	9

## 1. SAFETY CONSIDERATIONS

Read these *Safety Considerations for Operations* carefully before installing air conditioning equipment. After completing the installation, make sure that the unit operates properly during the start-up operation. Instruct the customer on how to operate and maintain the unit.

Inform customers that they should store this Operation Manual with the Installation Manual for future reference.

Meanings of **DANGER**, **WARNING**, **CAUTION**, and **NOTE** Symbols:

-  **DANGER** ..... Indicates an imminently hazardous situation which, if not avoided, will result in death or serious injury.
-  **WARNING** ..... Indicates a potentially hazardous situation which, if not avoided, could result in death or serious injury.
-  **CAUTION** ..... Indicates a potentially hazardous situation which, if not avoided, may result in minor or moderate injury. It may also be used to alert against unsafe practices.
-  **NOTE**..... Indicates situations that may result in equipment or property-damage accidents only.

---

### **DANGER**

---

- Do not install the unit in an area where flammable materials are present due to risk of explosion resulting in serious injury or death.
- Any abnormalities in the operation of the air conditioner such as smoke or fire could result in severe injury or death. Turn off the power and contact your dealer immediately.
- Refrigerant gas may produce toxic gas if it come in contact with fire, such as from a fan, heater, stove, or cooking device. Exposure to this gas could cause severe injury or death.
- For refrigerant leakage, consult your dealer. Refrigerant gas is heavier than air and replaces oxygen. A massive leak could lead to oxygen depletion, especially in basements, and an asphyxiation hazard could occur leading to serious injury or death.
- If equipment utilizing a burner is used in the same room as the air conditioner, there is the danger of oxygen deficiency which could lead to an asphyxiation hazard resulting in serious injury or death. Be sure to ventilate the room sufficiently to avoid this hazard.
- Safely dispose of the packing materials. Packing materials, such as nails and other metal or wooden parts, may cause stabs or other injuries.
- Tear apart and throw away plastic packaging bags so that children will not play with them. Children playing with plastic bags face the danger of death by suffocation.

---

### **WARNING**

---

- Contact your dealer for repair and maintenance. Improper repair and maintenance may result in water leakage, electric shock, and fire. Only use accessories made by Daikin that are specifically designed for use with the equipment and have them installed by a professional.
- Contact your dealer to move and reinstall the air conditioner. Incomplete installation may result in water leakage, electric shock, and fire.
- Never let the indoor unit or the remote controller get wet. Water can cause an electric shock or a fire.
- Never use flammable spray such as hair spray, lacquer, or paint near the unit. Flammable spray may cause a fire.

- When a fuse blows out, never replace it with one of incorrect ampere ratings or different wires. Always replace any blown fuse with a fuse of the same specification.
- Never remove the fan guard of the unit. A fan rotating at high speed without the fan guard is very dangerous.
- Never inspect or service the unit by yourself. Contact a qualified service person to perform this work.
- Turn off all electrical power before doing any maintenance to avoid the risk of serious electric shock; never sprinkle or spill water or liquids on the unit.
- Do not touch the switch with wet fingers. Touching a switch with wet fingers can cause electric shock.
- Do not allow children to play on or around the unit to prevent injury.
- The heat exchanger fins are sharp enough to cut. To avoid injury wear gloves or cover the fins while working around them.
- Do not put a finger or other objects into the air inlet or air outlet. The fan is rotating at high speed and will cause injury.
- Check the unit foundation for damage on a continuous basis, especially if it has been in use for a long time. If left in a damaged condition the unit may fall and cause injury.
- Placing a flower vase or other containers with water or other liquids on the unit could cause a shock or fire if a spill occurs.
- Do not touch the air outlet or horizontal blades while the swing flap is in operation because fingers could get caught and injured.
- Never touch the internal parts of the controller. Do not remove the front panel because some parts inside are dangerous to touch. To check and adjust internal parts, contact your dealer.
- Be sure to establish an earth. Do not earth the unit to a utility pipe, arrester, or telephone earth. Incomplete earth may cause electrical shock, or fire. A high surge current from lightning or other sources may cause damage to the air conditioner.
- Be sure to install an earth leakage breaker. Failure to install an earth leakage breaker may result in electric shocks, or fire.

---

 **CAUTION**

- Do not use the air conditioner for any other purposes other than comfort cooling or heating. Do not use the unit for cooling precision instruments, food, plants, animals or works of art.
  - Do not place items under the indoor unit as they may be damaged by condensates that may form if the humidity is above 80% or if the drain outlet gets blocked.
  - Before cleaning, stop the operation of the unit by turning the power off or by pulling the supply cord out from its receptacle. Otherwise, an electric shock and injury may result.
  - Do not wash the air conditioner with excessive water. An electric shock or fire may result.
  - Avoid placing the controller in a spot splashed with water. Water entering the controller may cause an electric shock or damage the internal electronic parts.
  - Do not operate the air conditioner when using a roomfumigation type of insecticide. Failure to observe this could cause the chemicals to be deposited in the unit and can endanger the health of those who are hypersensitive to chemicals.
  - Do not turn off the power immediately after stopping operation. Always wait for at least five minutes before turning off the power. Otherwise, water leakage may occur.
  - The appliance is not intended for use by young children or infirm persons without supervision.
  - The remote controller should be kept away from children so they cannot play with it.
  - Consult with the installation contractor for cleaning.
  - Incorrect cleaning of the inside of the air conditioner could make the plastics parts break and cause water leakage or electric shock.
  - Do not touch the air inlet or aluminum fin of the air conditioner as they can cut and cause injury.
  - Do not place objects in direct proximity of the outside unit. Do not let leaves and other debris accumulate around the unit. Leaves are a hotbed for small animals which can enter the unit. Once inside the unit, animals can cause the unit to malfunction, and cause smoke or fire when they make contact with electrical parts.
-

—  NOTE —

- Never press the button of the remote controller with a hard, pointed object. The remote controller may be damaged.
- Never pull or twist the electric wire of the remote controller. It may cause the unit to malfunction.
- Do not place appliances that produce open flames in places that are exposed to the air flow of the unit or under the indoor unit. It may cause incomplete combustion or deformation of the unit due to the heat.
- Do not expose the controller to direct sunlight. The LCD display can become discolored and may fail to display the data.
- Do not wipe the controller operation panel with benzene, thinner, chemical dust cloth, etc. The panel may get discolored or the coating can peel off. If it is heavily dirty, soak a cloth in water-diluted neutral detergent, squeeze it well and wipe the panel clean. Then wipe it with another dry cloth.
- Dismantling of the unit, disposal of the refrigerant, oil, and additional parts, should be done in accordance with the relevant local, state, and national regulations.
- Operate the air conditioner in a sufficiently ventilated area and not surrounded by obstacles. Do not use the air conditioner in the following places.
  - a. Places with a mist of mineral oil, such as cutting oil.
  - b. Locations such as coastal areas where there is a lot of salt in the air.
  - c. Locations such as hot springs where there is a lot of sulfur in the air.
  - d. Locations such as factories where the power voltage varies a lot.
  - e. In cars, boats, and other vehicles.
  - f. Locations such as kitchens where oil may splatter or where there is steam in the air.
  - g. Locations where equipment produces electromagnetic waves.
  - h. Places with an acid or alkaline mist.
  - i. Places where fallen leaves can accumulate or where weeds can grow.
- Take snow protection measures. Contact your dealer for the details of snow protection measures, such as the use of a snow protection hood.

- Do not attempt to do electrical work or grounding work unless you are licensed to do so. Consult with your dealer for electrical work and grounding work.
- Pay Attention to Operating Sound. Be sure to use the following places:
  - a. Places that can sufficiently withstand the weight of the air conditioner yet can suppress the operating sound and vibration of the air conditioner.
  - b. Places where warm air from the air outlet of the outside unit or the operating sound of the outside unit does not annoy neighbors.
- Make sure that there are no obstacles close to the outside unit. Obstacles close to the outside unit may drop the performance of the outside unit or increase the operating sound of the outside unit.
- Consult your dealer if the air conditioner in operation generates unusual noise.
- Make sure that the drainpipe is installed properly to drain water. If no water is discharged from the drainpipe while the air conditioner is in the cooling mode, the drainpipe may be clogged with dust or dirt and water leakage from the indoor unit may occur. Stop operating the air conditioner and contact your dealer.

---

## 2. OUTDOOR-AIR PROCESSING UNIT : NAME OF EACH PART (Refer to figure 1)

1. Air outlet
2. Remote controller
3. Air filter (Optional accessory)
4. Ground wire
5. Electrical components box
6. Outdoor air inlet
7. Refrigerant pipe and interconnecting wire
8. Power wire
9. Drain pipe
10. Heat exchanger
11. Fan

### 3. REMOTE CONTROLLER : NAME AND FUNCTION OF EACH SWITCH AND DISPLAY (Refer to figure 2)

#### 1. On/off button

Press the button and the system will start. Press the button again and the system will stop.

#### 2. Operation lamp (red)

The lamp lights up during operation.

#### 3. Display “”

##### (changeover under control)

It is impossible to change heat/cool with the remote controller when this icon is displayed.

#### 4. Display “FAN” “” “COOL” “HEAT” (operation mode)

This display shows the current operation mode.

#### 5. Display “ OFF” (inspection/test operation)

When the inspection/test operation button is pressed, the display shows the mode in which the system actually is.

#### 6. Display “” (under centralized control)

When this display shows, the system is under centralized control.

(This is not a standard specification.)

#### 7. Display “” (time to clean air filter)

When this display shows, it is the time to clean air filter.

(The air filter is an optional accessory.)

#### 8. Display “” (defrost/hot start)

Refer to the chapter “OPERATION PROCEDURE - EXPLANATION OF HEATING OPERATION.”

#### 9. Inspection/test operation button

This button is only used by qualified service persons for maintenance purposes.

#### 10. Filter sign reset button

Refer to the chapter “MAINTENANCE”.

#### 11. Operation mode selector button

Press this button to select the operation mode of your preference.

#### 12. Display NOT AVAILABLE “”

“” is displayed whenever a non-installed option is addressed or a function is not available.

### NOTE

- In contradistinction to actual operating situations, the display on figure 2 shows all possible indications.
- If the display “” (time to clean air filter) shows, clean the air filter as explained in the chapter “MAINTENANCE”. After cleaning and reinstalling the air filter, press the filter sign reset button on the remote controller. The filter sign lamp on the display will go out.
- This operation manual is for the Outdoor-Air Processing Unit.  
See the outdoor unit’s operation manual for details on the indoor unit for room air conditioning.
- See the remote controller's operation manual for details on the schedule timer.

### 4. OPERATION RANGE

Use the system in the following temperature and humidity ranges for safe and effective operation.

#### COOLING [°F]

OUTDOOR TEMPERATURE		
TEMPERATURE		HUMIDITY
D B	66 to 109 (Note)	30% to 90% (Long time operation in a humidity over 90% may cause condensation on the unit and dripping.)
W B	89 or below	

DB: Dry bulb temperature

WB: Wet bulb temperature

### NOTE

- The FAN OPERATION mode is set automatically for DB temperature of 66°F and below.
- Do not use the COOLING OPERATION or FAN OPERATION modes when outdoor temperature is 41°F or lower. The unit will stop running to protect itself against cold damage. In such case, set the AUTOMATIC OPERATION or HEATING OPERATION mode.

#### HEATING [°F]

OUTDOOR TEMPERATURE	
D B	23 to 59 (Note)

DB: Dry bulb temperature

### NOTE

- The FAN OPERATION mode is set automatically for DB temperature of 59°F and above.

If the temperature or the humidity is beyond these conditions, safety devices may work and the unit may not operate.



## 5. OPERATION PROCEDURE

- To protect the unit, turn on the power supply 6 hours before operation.
- If the power supply is turned off during operation, operation will restart automatically after the power turns back on again.
- This unit cannot control room temperature. If room temperature control is needed, install it together with the indoor unit for room air conditioning.
- This unit is designed to operate so that the temperature of the outlet air is as close as possible to the set temperature. This may not be possible, however, due to the outdoor air temperature. When shipped from the factory, the set temperature is set at 64°F for cooling and 77°F for heating. The set temperature can be changed between 55 and 77°F for cooling / 64 and 86°F for heating by local setting from remote controller. About set temperature or how to change it, ask your dealer. The set temperature will not be displayed on the remote controller.

### 5-1 COOLING, HEATING, AUTOMATIC, AND FAN ONLY OPERATION (Refer to figure 3)

- Changeover cannot be made with a remote controller whose display shows “CENTRAL CONTROL” (changeover under control).
- When the display “CENTRAL CONTROL” (changeover under control) flashes, refer to the chapter “5-2 SETTING THE MASTER REMOTE CONTROLLER”.
- The fan may keep on running for about 1 minute after the heating operation stops.
- The fan may stop immediately. This is not a malfunction.

#### Starting the system

- 1 Press the operation mode selector button several times and select the operation mode of your choice;

“COOL” Cooling operation

“HEAT” Heating operation

“AUTO” Automatic operation

“FAN” Fan only operation

#### NOTE

- Cooling / Heating operation  
Outdoor air is cooled or warmed and brought indoors.
- Automatic operation  
In this operation mode, cool/heat changeover is automatically conducted.
- Fan only operation  
Outdoor air is brought indoors as is.

- 2 Press the on/off button.  
The operation lamp lights up and the system starts operation.

#### Stopping the system

- 3 Press the on/off button once again.  
The operation lamp goes off and the system stops operation.

#### NOTE

- Do not turn off the power supply immediately after the unit stops, but wait for at least 5 minutes.

### EXPLANATION OF HEATING OPERATION

#### Defrost operation

- In heating operation, freezing of the outdoor unit coil increases. Heating capability decreases and the system goes into defrost operation.
- The indoor unit fan stops and the remote controller displays “STANDBY”.
- After maximum 12 minutes of defrost operation, the system returns to heating operation again.

#### Hot start

- In order to prevent cold air from blowing out of an indoor unit at the start of heating operation, the indoor fan is automatically stopped. The display of the remote controller shows “STANDBY”.

### 5-2 SETTING THE MASTER REMOTE CONTROLLER (Refer to figure 4)

- When the system is installed as shown in figure 5 and 6, it is necessary to designate one of the remote controllers as the master remote controller.
- When one outdoor unit is connected with several outdoor-air processing units, designate one of the remote controllers as the master remote controller. (Refer to figure 5)

- When one outdoor unit is connected with outdoor-air processing units and indoor units for room air conditioning, designate one of the remote controllers of the indoor units as the master remote controller. **(Refer to figure 6)**

Otherwise, operation of system will be changed by outdoor air condition during automatic operation.

- Only the master remote controller can select heating, cooling or automatic (Only if the remote controller of outdoor air processing unit is designated as the master remote controller.) operation.
- The displays of slave remote controllers show “” (changeover under control) and they automatically follow the operation mode directed by the master remote controller.
- However, it is possible to change to fan only operation with slave remote controllers.

#### How to designate the master remote controller (Refer to figure 4)

- 1 Press the operation mode selector button of the current master remote controller for 4 seconds.

The display showing “” (changeover under control) of all slave remote controllers connected to the same outdoor unit flashes.

- 2 Press the operation mode selector button of the controller that you wish to designate as the master remote controller. Then designation is completed. This remote controller is designated as the master remote controller and the display showing “” (changeover under control) vanishes.

The displays of other remote controllers show “” (changeover under control).

### 5-3 PRECAUTIONS FOR GROUP CONTROL SYSTEM OR TWO REMOTE CONTROLLERS CONTROL SYSTEM

This system provides two other control systems beside individual control (one remote controller controls one indoor unit) system. Confirm the following if your unit is of the following control system type.

#### • Group control system

One remote controller controls up to 16 indoor units. All indoor units are equally set.

#### • Two remote controllers control system

Two remote controllers control one indoor unit (in case of group control system, one group of indoor units). The unit is individually operated.

#### NOTE

- Contact your Daikin dealer in case of changing the combination or setting of group control and two remote controllers control systems.

## 6. OPTIMUM OPERATION

Observe the following precautions to ensure the system operates properly.

- Adjust the air outlet properly and avoid direct air flow to room inhabitants.
- Adjust the room temperature properly for a comfortable environment. Avoid excessive heating or cooling.
- Prevent direct sunlight from entering a room during cooling operation by using curtains or blinds.
- Ventilate often.  
Extended use requires special attention to ventilation.
- Keep doors and windows closed. If the doors and windows remain open, air will flow out of your room causing a decrease in the cooling or heating effect.
- Never place objects near the air inlet or the air outlet of the unit. It may cause deterioration in the effect or stop the operation.
- Turn off the power supply to the unit when the unit is not used for longer periods of time. If the switch is on, it uses electricity. Before restarting the unit, turn on the power supply 6 hours before operation to ensure smooth running. (Refer to the chapter “OPERATION PROCEDURE”.)
- When the display shows “” (time to clean the air filter), ask a qualified service person to clean the filters. (Refer to the chapter “MAINTENANCE”.)
- Keep the indoor unit and remote controller at least 3.3 ft away from televisions, radios, stereos, and other similar equipment.  
Failing to do so may cause static or distorted pictures.
- It takes time for the room temperature to reach the set temperature.  
We recommend starting the operation in advance using timer operation.

## 7. MAINTENANCE

### ⚠ WARNING

- ONLY A QUALIFIED SERVICE PERSON IS ALLOWED TO PERFORM MAINTENANCE.
- BEFORE OBTAINING ACCESS TO TERMINAL DEVICES, ALL POWER SUPPLY CIRCUITS MUST BE INTERRUPTED.
- DO NOT USE WATER OR AIR OF 122°F OR HIGHER FOR CLEANING AIR FILTERS.

### 7-1 HOW TO CLEAN THE AIR FILTER

(The air filter is an optional accessory.)

#### About DAIKIN long life replacement filter

Clean the air filter when the display shows “” (time to clean air filter).

Increase the frequency of cleaning if the unit is installed in a room where the air is extremely contaminated.

(As a yardstick for regulating yourself, consider cleaning the filter.)

#### 1. Remove the air filters.

#### 2. Clean the air filter.

Use vacuum cleaner **A)** or wash the air filter with water **B)**.

**A)** Using a vacuum cleaner.



**B)** Washing with water.

To clean the air filter, use soft brush and neutral detergent.

Remove water and dry in the shade after cleaning.



#### 3. Fix the air filter.

#### 4. Press the FILTER SIGN RESET BUTTON on the remote controller.

The display “” (time to clean air filter) vanishes.

#### About other air filter.

Clean the air filter by suitable method in the filter.

#### NOTE

- Do not remove the air filter except when cleaning. Unnecessary handling may damage the filter.

## HOW TO CLEAN AIR OUTLET

### 1. Clean with soft cloth.

### 2. When it is difficult to remove stains, use water or neutral detergent.

#### NOTE

- Do not use gasoline, benzene, thinner, polishing powder, liquid insecticide. It may cause discolouring or warping.
- Do not let the unit get wet. It may cause an electric shock or a fire.

## 8. FOLLOWING SYMPTOMS ARE NOT SYSTEM TROUBLES

### 8-1 THE SYSTEM DOES NOT OPERATE

- **The system does not start immediately after the ON/OFF button on the remote controller is pushed.**

If the operation lamp lights, the system is in normal condition.

To prevent overloading of the compressor motor, the system starts 5 minutes after it is turned ON again in case it was turned OFF just before. The same starting delay occurs after the operation mode selector button was used.

- **If the display shows “” (under centralized control) and pressing the operation button causes the display to blink for a few seconds.**

This indicates that the central device is controlling the unit.

The blinking display indicates that the remote controller cannot be used.

- **The system does not start immediately after the power supply is turned on.**

Wait one minute until the micro computer is prepared for operation.

### 8-2 COOL/HEAT CANNOT BE CHANGED OVER

- **When the display shows “” (changeover under control), it shows that this is a slave remote controller.**

- **When the cool/heat changeover remote control switch is installed and the display shows “” (changeover under control).**

This is because cool/heat changeover is controlled by the cool/heat changeover remote control switch. Ask your Daikin dealer where the remote control switch is installed.

### **8-3 FAN OPERATION IS POSSIBLE, BUT COOLING AND HEATING DO NOT WORK**

- **When the outdoor temperature exceeds the range of use conditions, the unit automatically changes into fan mode from cooling or heating modes.**

### **8-4 NO AIR COMES OUT**

- **The outdoor temperature has dropped to 32°F or lower while in “cooling” or “fan” modes.**  
The fan automatically stops due to the outdoor air temperature.

### **8-5 WHITE MIST COMES OUT OF A UNIT**

#### **Outdoor-air processing unit**

- **When humidity is high during cooling operation.**

If the interior of the unit is extremely contaminated, the temperature distribution inside the unit becomes uneven. It is necessary to clean the interior of the unit. Ask your Daikin dealer for details on cleaning the unit. This operation requires a qualified service person.

- **Immediately after the cooling operation stops and if the outdoor temperature and humidity are low.**

This is because warm refrigerant gas flows back into the unit and generates steam.

#### **Outdoor-air processing unit, outdoor unit**

- **When the system is changed over to heating operation after defrost operation.**

Moisture generated by defrost becomes steam and is exhausted.

### **8-6 NOISE OF SYSTEM**

#### **Outdoor-air processing unit**

- **A “zeen” sound is heard immediately after the power supply is turned on.**

The electronic expansion valve inside the unit starts working and makes the noise. Its volume will reduce in about one minute.

- **A “pishi-pishi” squeaking sound is heard when the system stops after heating operation.**

Expansion and contraction of plastic parts caused by temperature change make this noise.

- **A low “sah”, “choro-choro” sound is heard while the unit is stopped.**

When the other unit is in operation, this noise is heard. In order to prevent oil and refrigerant from remaining in the system, a small amount of refrigerant is kept flowing.

#### **Outdoor-air processing unit, outdoor unit**

- **A continuous low hissing sound is heard when the system is in cooling or defrost operation.**

This is the sound of refrigerant gas flowing through the system.

- **A hissing sound which is heard at the start or immediately after stopping operation or defrost operation.**

This is the noise of refrigerant caused by flow stop or flow change.

#### **Outdoor unit**

- **When the tone of operating noise changes.**

This noise is caused by the change of frequency.

### **8-7 DUST COMES OUT OF THE UNIT**

- **When the unit is used after having stopped operating for a long time.**

This is because dust has gotten into the unit.

### **8-8 THE UNITS MAY GIVE OFF ODOURS**

- **The unit may absorb the smell of outdoor air.**

### **8-9 THE OUTDOOR UNIT FAN DOES NOT SPIN**

- **During operation.**

The speed of the fan is controlled in order to optimize product operation.

### **8-10 THE DISPLAY SHOWS “88”**

- **This is the case immediately after the power supply is turned on and means that the remote controller is in normal condition. This continues for one minute.**

### **8-11 THE COMPRESSOR IN THE OUTDOOR UNIT DOES NOT STOP AFTER A SHORT HEATING OPERATION**

- **This is to prevent oil and refrigerant from remaining in the compressor. The unit will stop after 5 to 10 minutes.**

### **8-12 THE INSIDE OF AN OUTDOOR UNIT IS WARM EVEN WHEN THE UNIT HAS STOPPED**

- **This is because the crankcase heater is warming the compressor so that the compressor can start smoothly.**

## 9. TROUBLE SHOOTING

**If one of the following malfunctions occur, take the measures shown below and contact your Daikin dealer.**

**The system must be repaired by a qualified service person.**

- If a safety device such as a fuse, a breaker or ground fault circuit interrupter frequently actuates, or the ON/OFF switch does not properly work;  
Measure: Turn off the power supply.
- If water leaks from unit;  
Measure: Stop the operation.
- If the display “ OFF”, the unit number and the operation lamp flash and the malfunction code appears; **(Refer to figure 7)**
  1. Inspection display
  2. Unit number in which a malfunction occurs
  3. Operation lamp
  4. Malfunction codeMeasure: Notify your Daikin dealer and report the malfunction code.

**If the system does not properly operate except for the above mentioned cases and none of the above mentioned malfunctions is evident, investigate the system according to the following procedures.**

1. If the system does not operate at all;
  - Check if there is no power failure.  
Wait until power is restored. If power failure occurs during operation, the system automatically restarts immediately after the power supply is recovered.
  - Check if no fuse has blown or breaker has worked.  
Change the fuse or reset the breaker if necessary.
2. If the system goes into fan only operation, but as soon as it goes into heating or cooling operation, the system stops;
  - Check if air inlet or outlet of outdoor unit or outdoor-air processing unit is not blocked by obstacles.  
Remove any obstacle and make it well-ventilated.
  - Check if the remote controller display shows “ ” (time to clean the air filter). (Refer to the chapter “MAINTENANCE”.)
3. The system operates but cooling or heating is insufficient;
  - Check if air inlet or outlet of outdoor or outdoor-air processing unit is not blocked by obstacles.  
Remove any obstacle and make it well-ventilated.
  - Check if the air filter is not clogged. (Refer to the chapter “MAINTENANCE”.)

**DAIKIN AC (AMERICAS), INC.**

1645 Wallace Drive, Suite 110  
Carrollton, TX 75006

info@daikinac.com  
www.daikinac.com

**DAIKIN INDUSTRIES, LTD.**

Head office:

Umeda Center Bldg., 2-4-12, Nakazaki-Nishi,  
Kita-ku, Osaka, 530-8323 Japan

Tokyo office:

JR Shinagawa East Bldg., 2-18-1, Konan,  
Minato-ku, Tokyo, 108-0075 Japan

