



Installation, Operation, and Maintenance Manual

IOM 1242-10

Group: Chiller

Part Number: IOM1242-10

Date: October 2023

Pathfinder® Air-cooled Screw Chillers

Model AWV
100 to 565 Tons (350 to 1985 kW)
R-134a or R-513A Refrigerant
60/50 Hz

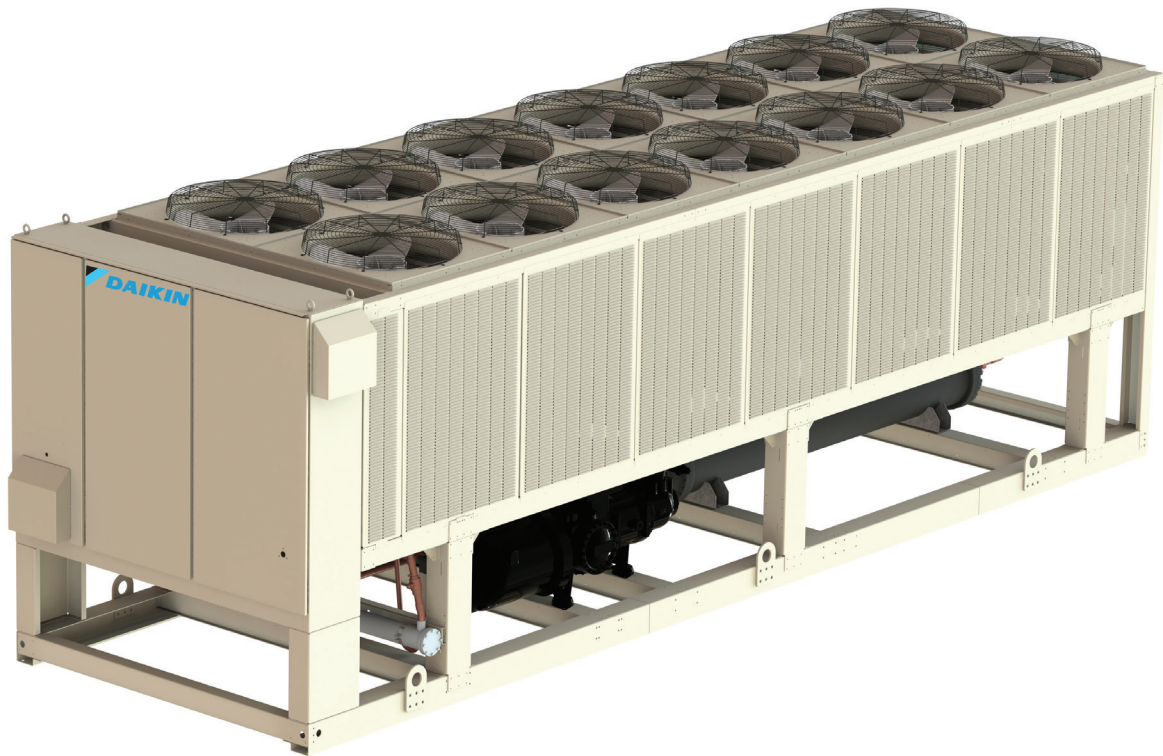

Table of Contents

Introduction	5
Installation and Application Considerations	7
Remote Evaporators	33
Pump Packages	40
Dimensional Drawings	42
Isolator Information	45
Pressure Drop Data	46
Controller Operation	49
Set Points	54
Unit Functions	59
Circuit Functions	67
Circuit Status	69
Alarms and Events	79
Unit Controller Operation	94
Startup and Shutdown	96
System Maintenance	101

Manufactured in an ISO 9001 & ISO 14001 certified facility



©2023 Daikin Applied, Minneapolis, MN. All rights reserved throughout the world. This document contains the most current product information as of this printing. Daikin Applied Americas Inc. has the right to change the information, design, and construction of the product represented within the document without prior notice. For the most up-to-date product information, please go to www.DaikinApplied.com.

™® Pathfinder, MicroTech, and Daikin Applied are trademarks or registered trademarks of Daikin Applied Americas Inc. The following are trademarks or registered trademarks of their respective companies: BACnet from American Society of Heating, Refrigerating and Air-Conditioning Engineers, Inc.; Echelon, LonWorks, LonMark, and LonTalk from Echelon Corporation; Modbus from Schneider Electric; and Windows from Microsoft Corporation.



Pre-Start Checklist – Screw Chillers

Must be completed, signed and provided to Daikin Applied at least 2 weeks prior to requested start date.

Job Name				
Installation Location				
Customer Order Number				
Model Number(s)				
G.O. Number(s)				
Chilled Water and Condenser Water for Water-cooled Chiller	Yes	No	N/A	Initials
Piping complete				
Water strainer(s) installed in piping per manual requirements				
Water System – flushed, filled, and vented; Water treatment in place				
Cooling tower flushed, filled, vented; Water treatment in place (if applicable)				
Pumps installed and operational (rotation checked, strainers installed and cleaned)				
Controls operational (3-way valves, face/bypass dampers, bypass valves, etc.)				
Water system operated and tested; flow meets unit design requirements				
Flow switch(es) - installed, wired, and calibrated				
Vent installed on evaporator				
Glycol at design % (if applicable)				
Electrical	Yes	No	N/A	Initials
Building controls operational				
*Power leads connected to power block or optional disconnect				
Power leads have been checked for proper phasing and voltage				
All interlock wiring complete and compliant with Daikin Applied specifications				
Power applied at least 24 hours before startup				
Oil heaters energized at least 24 hours before startup (not applicable for WWV models)				
Chiller components (EXV Sensors Transducers) installed and wired properly				
*Wiring complies with National Electrical Code and local codes (see notes)				
Remote EXV wired with shielded cable (if applicable)				
Miscellaneous	Yes	No	N/A	Initials
Unit control switches all off				
Remote Evaporator Piping factory reviewed and approved (if applicable)				
All refrigerant components/piping leak tested, evacuated and charged				
Thermometers, wells, gauges, control, etc., installed				
Minimum system load of 80% capacity available for testing/adjusting controls				
SiteLine™ cloud-connected controls included and needs to be commissioned				
Document Attached: Technical Data Sheet from Selection Software				
Document Attached: Final Order Acknowledgement				
Document Attached: Remote evaporator piping approval (if applicable)				
Notes: The most common problems delaying start-up and affecting unit reliability are:				
1. Field installed compressor motor power supply leads too small. Questions: Contact the local Daikin Applied sales representative*. State size, number and type of conductors and conduits installed:				
a. From Power supply to chiller _____				
2. Refer to NEC Article 430-22 (a)				
2. Remote Evaporator piping incomplete or incorrect. Provide approved piping diagrams.				
3. Items on this list incorrectly acknowledged may result in delayed start and extra expenses incurred for return trips.				

Cut Here ✂

Contractor Representative

Signed: _____
 Name: _____
 Company: _____
 Date: _____
 Phone/Email: _____

Daikin Applied Sales Representative

Signed: _____
 Name: _____
 Company: _____
 Date: _____
 Phone/Email: _____

THIS PAGE INTENTIONALLY LEFT BLANK

Introduction

This manual provides installation, operation, and maintenance information for Daikin Applied Pathfinder® model AWW screw chillers with a MicroTech® Unit controller.

NOTE: Installation and maintenance are to be performed only by licensed, if required by local codes and regulations, or qualified personnel who are familiar with local codes and regulations and are experienced with this type of equipment.

 **DANGER**

LOCKOUT/TAGOUT all power sources prior to starting, pressurizing, de-pressurizing, or powering down the Chiller. Failure to follow this warning exactly can result in serious injury or death. Be sure to read and understand the installation, operation, and service instructions within this manual.

 **WARNING**

Electric shock hazard. Improper handling of this equipment can cause personal injury or equipment damage. This equipment must be properly grounded. Connections to and service of the MicroTech unit control panel must be performed only by personnel that are knowledgeable in the operation of the equipment being controlled.

 **CAUTION**

Static sensitive components. A static discharge while handling electronic circuit boards can cause damage to the components. Use a static strap before performing any service work. Never unplug any cables, circuit board terminal blocks, or power plugs while power is applied to the panel.

 **CAUTION**

When moving refrigerant to/from the chiller using an auxiliary tank, a grounding strap must be used. An electrical charge builds when halo-carbon refrigerant travels in a rubber hose. A grounding strap must be used between the auxiliary refrigerant tank and the chiller's end sheet (earth ground), which will safely take the charge to the ground. Damage to sensitive electronic components could occur if this procedure is not followed.

 **CAUTION**

This equipment generates, uses, and can radiate radio frequency energy. If not installed and used in accordance with this instruction manual, it may cause interference with radio communications. Operation of this equipment in a residential area may cause harmful interference in which case the owner will be required to correct the interference at the owner's own expense.

Daikin Applied disclaims any liability resulting from any interference or for the correction thereof.

 **WARNING**

Polyolester Oil, commonly known as POE oil, is a synthetic oil used in many refrigeration systems and may be present in this Daikin Applied product. POE oil, if ever in contact with PVC/CPVC, will coat the inside wall of PVC/CPVC pipe causing environmental stress fractures. Although there is no PVC/CPVC piping in this product, please keep this in mind when selecting piping materials for your application, as system failure and property damage could result. Refer to the pipe manufacturer's recommendations to determine suitable applications of the pipe.

Hazard Identification Information

 **DANGER**

Danger indicates a hazardous situation, which will result in death or serious injury if not avoided.

 **WARNING**

Warning indicates a potentially hazardous situations, which can result in property damage, personal injury, or death if not avoided.

 **CAUTION**

Caution indicates a potentially hazardous situations, which can result in minor injury or equipment damage if not avoided.

NOTICE

Notice indicates practices not related to physical injury.

NOTE: Indicates important details or clarifying statements for information presented.

General Description

Daikin Applied Pathfinder model AWV chillers are complete, self-contained, automatically controlled, liquid-chilling units featuring variable speed screw compressors. All model AWV chillers are equipped with a single evaporator and microchannel condenser coils along with two compressors.

NOTICE

Pathfinder chillers are designed for outdoor installation only. The chillers use refrigerant HFC-134a or optional R-513A that has no ozone depletion level.

Only normal field connections such as water piping, electric power, and control interlocks are required, thereby simplifying installation and increasing reliability. Necessary equipment protection and operating controls are included.

All Daikin Applied screw chillers must be commissioned by a Daikin Applied service technician or an authorized service provider. Failure to follow this startup procedure can affect the equipment warranty.

The standard limited warranty on this equipment covers parts that prove defective in material or workmanship. Specific details of this warranty can be found in the warranty statement furnished with the equipment.

Nomenclature

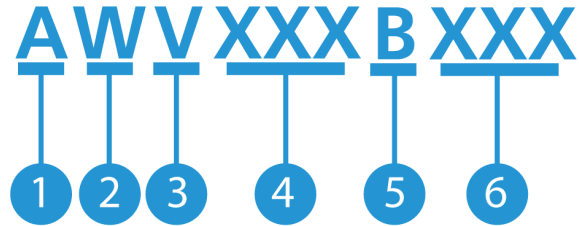

No.	Description
1	A = Aircooled
2	W = World
3	V = Variable Speed Chiller
4	Number of Fans
5	Design Vintage
6	Compressor Code

Operating Limits

Table 1: Operating/Standby Limits

Ambient		
Maximum standby temperature	130°F (54.4°C)	
NOTE: Maximum operating ambient temperature is determined by unit configuration		
Minimum ambient temperature	Starting	Operating
Standard ambient control	32°F (0°C)	32°F (0°C)
Low ambient control with variable speed fan option	-10°F (-23.3°C)	-20°F (-28.9°C)
Low ambient control, variable speed fan option, and IWSE (full IWSE mode only)	-20°F (-28.9°C)	-20°F (-28.9°C)
Low ambient control, higher speed/static ECM/DCM fan motors, and IWSE (full IWSE mode only and requires field provided heat trace on control valves)	-30°F (-34.4°C)	-30°F (-34.4°C)
Water		
Leaving chilled water temperature (water only)	40°F to 70°F (4.4°C to 21.1°C)	
Leaving chilled fluid temperatures (with anti-freeze)	17°F to 70°F (-8.3°C to 21.1°C)	
NOTE: Unloading is not permitted with fluid leaving temperatures below 25°F (-3.9°C).		
Operating chilled water delta-T range	6°F to 20°F (3.3°C to 11.1°C)	
Maximum evaporator operating inlet fluid temperature	88°F (31.1°C)	
Maximum evaporator non-operating inlet fluid temperature	100°F (38°C)	

Installation and Application Considerations

Nameplates

Identification nameplates on the chiller:

- The unit nameplate is located on the exterior of the Unit Power Panel. Both the Model No. and Serial No. are located on the unit nameplate; the Serial No. is unique to the unit. These numbers should be used to identify the unit for service, parts, or warranty questions. This plate also has the unit refrigerant charge and electrical ratings.
- Vessel nameplate is located on the evaporator. They have a National Board Number (NB) and a serial number, either of which identify the vessel (but not the entire unit).
- Compressor nameplate is located on each compressor and gives pertinent electrical information.

Lifting Guidance

Daikin Applied equipment is designed to withstand the loads of the lifting and rigging process resulting from ASME Standard P30.1 - Planning for Load Handling Activities or equivalent. Lifting guidance is intended for installations of newly delivered equipment. If moving previously installed equipment for re-location or disposal, consideration should be given to unit condition. Equipment should also be drained as unit weight and center of gravity values do not reflect the addition of water for lifting.

⚠ DANGER

Improper rigging, lifting, or moving of a unit can result in unit damage, property damage, severe personal injury or death. See the as-designed, certified dimensioned drawings included in the job submittal for the weights and center of gravity of the unit. If the drawings are not available, consult the local Daikin Applied sales office for assistance.

Installation is to be performed only by qualified personnel who are familiar with local codes and regulations, and experienced with this type of equipment. Lifting equipment and mechanisms must be determined by the Lifting Director per the current version of ASME Standard P30.1 or equivalent and must be suited for the load capacity. Daikin Applied is not a licensed nor certified rigging specialist. Therefore it is the customer's responsibility to consult a certified rigging contractor to rig, lift, and move components and subcomponents properly and safely as needed.

⚠ CAUTION

Forklifts may not be used to lift or move AWW units as the method may result in unit damage.

⚠ CAUTION

When around sharp edges, wear appropriate Personal Protective Equipment (PPE), such as gloves, protective clothing, foot wear, eye protection, etc. to prevent personal injury.

Lifting Brackets

Lifting bracket designs vary from product to product. Rules of engagement with the lifting brackets are the same regardless of the bracket type. For Pathfinder units, a typical lifting bracket with 2" (51 mm) diameter holes found on the sides of the unit base are illustrated in Figure 1. See the as-designed certified drawings for specific lifting points on this product model.

Engagement with each bracket is to be as close to vertical as possible. The maximum allowable lift angle from the vertical is 30 degrees as shown in Figure 2. If the lift angle shifts beyond 30° from vertical on any of the lift points, the lift shall not proceed until a plan and rigging can be secured that will correct the angle of lift.

⚠ WARNING

The lifting angle must not go beyond 30 degrees from vertical or the unit can become unstable which may result in unit damage, property damage, severe personal injury, or death.

Figure 1: Illustration of Lifting Bracket and Allowed Angle for Lifting

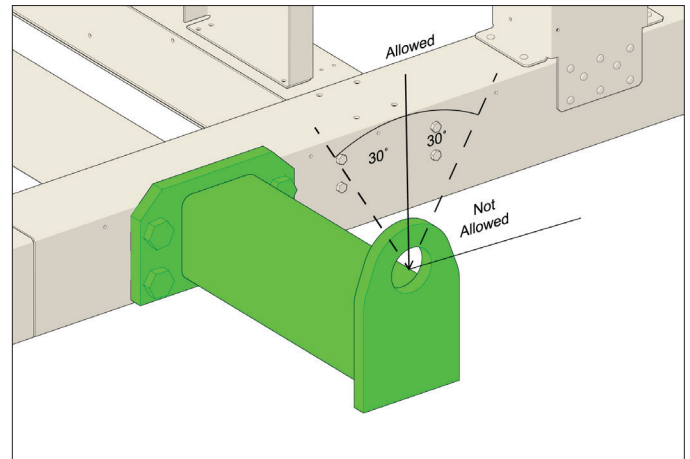

Figure 2: Illustration of Allowed Angle Label

⚠ WARNING

All factory provided lifting points must be used. Unit must remain level during lift and transit!

The lifting and tie-down angle must not go beyond 30 degrees from vertical or the unit can become unstable which may result in unit damage, property damage or severe personal injury or death.

Lifting Equipment

Lifting equipment is supplied by the user or their designate. This is typically selected around the unit certified information of the equipment to be lifted and the available lifting equipment planned to be at the site where the lift is to take place. It is the responsibility of the Lifting Director to follow a standard practice of lift planning and equipment selection, like that found in the ASME P30 series of standards. Lifting plan and equipment must ensure that the only contact with the unit is at the lifting brackets. Straps, chains or spreader bars that are likely to be used shall not come in contact with the unit.

⚠ CAUTION

Lifting mechanisms must not make contact with the unit beyond the lifting bracket. Extreme care must be used when rigging the unit to prevent damage to the control panels, unit handles, unit piping, and unit frame.

Lifting Points

Lifting points are predetermined by design. Figure 3 illustrates a typical 10-point lifting configuration, with five lifting points on each side of the unit. When lifting, all factory installed lifting brackets must be used. The unit must remain level throughout the entire lifting event. Level is defined as one end being no more than 0.25" per foot of unit length to the opposite end.

⚠ WARNING

Be aware that the center of gravity may not necessarily be in the geometric center of the unit. No additional items can be added to a lift with the unit as it may affect the center of gravity and cause unit damage, property damage, severe personal injury, or death. Refer to as-designed, certified drawings for weight, center of gravity location and details specific to unit configuration.

Figure 3: Typical Lifting Points Locations

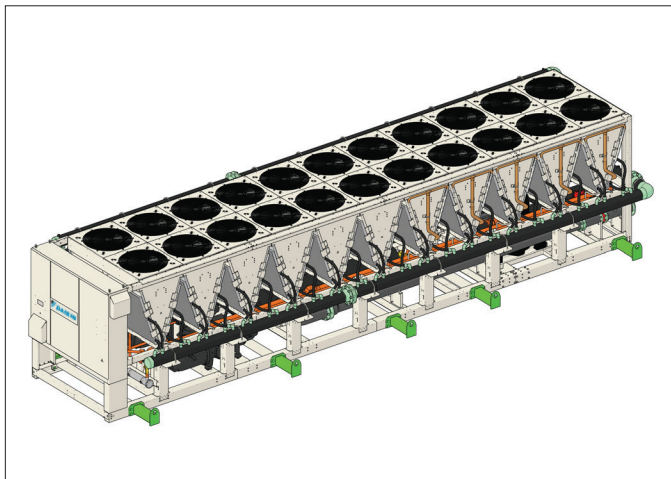

Transit and Temporary Storage

If the unit is stored for an intermediate period before installation or moved to a different location, take these additional precautions:

1. Support the unit well along the length of the base rail.
2. Level the unit (no twists or uneven ground surface).
3. Provide proper drainage around the unit to prevent flooding of the equipment.
4. Provide adequate protection from vandalism, mechanical contact, etc.
5. Securely close the doors and lock the handles.
6. If there are isolation dampers, make sure they are properly installed and fully closed to prevent the entry of animals and debris through the supply and return air openings.
7. Cover the supply and return air openings on units without isolation dampers.
8. Long term storage in humid environments may cause condensate corrosion on steel surfaces. Consider adding a desiccant material to alleviate corrosion concerns.

When the unit is being tied down for transit, the maximum allowable attachment angle from the vertical is 30 degrees in the opposite direction of lifting in Figure 2. Shimming of the unit under the lifting brackets or tie-down points must be used to ensure even contact along the length of the base rail.

Long Term Storage

This information applies to new units being stored waiting for startup or existing units that may be inoperative or in storage for **four** months or more.

The chiller must be stored in a secure location and protected from any damage or sources of corrosion while in storage. A Daikin Applied service representative must perform a leak test and visual inspection for any damage or unusual conditions affecting the unit on a minimum quarterly schedule, to be paid by the owner or contractor. Daikin Applied will not be responsible for any refrigerant loss during the storage time, for repairs to the unit during the storage period, or while moving the unit from the original location to a storage facility and back to any new installation location. If there is concern about the possibilities of damage and loss of charge during storage, the customer can have the charge removed and stored in recovery cylinders.

⚠ CAUTION

If the temperature of where the chiller is located is expected to exceed 130°F (54.4°C), then the refrigerant must be removed.

It is necessary to observe additional precautions during long term storage.

- Do not keep the machine near a heat source and/or open flame
- Humid environments may cause condensate corrosion on steel surfaces. Consider adding a desiccant material to alleviate corrosion concerns.
- For units previously installed, ensure water has been drained from the unit or sufficient glycol has been added if ambient temperature may be lower than 40°F (4.4°C).

For additional tasks required, contact a Daikin Applied service representative.

Unit Placement

Locate the unit outdoors and provide proper airflow to the condenser, see [Figure 4](#). Using less clearance than shown for required clearances can cause discharge air recirculation to the condenser and could significantly reduce unit performance.

Pathfinder units are for outdoor applications and can be mounted either on a roof or at ground level. For roof mounted applications, install the unit on a steel channel or I-beam frame to support the unit above the roof. Spring isolators are recommended for all roof-mounted installations due to vibration transmission considerations.

For ground level applications, the unit must be installed on a substantial base that will not settle. Use a one-piece concrete slab with footings extended below the frost line. The foundation must be level within 13 mm (1/2 inch) over its length and width and strong enough to support the unit operating weight as listed on the unit submittal documents. The addition of neoprene waffle pads (supplied by customer) under the unit may allow water to drain from inside the frame, which can act as a dam. Installation of optional spring or rubber-in-shear isolators can also assist with drainage, see [page 45](#) for information.

On ground level applications, protection against vandalism is recommended; either by the optional factory-installed lower wire mesh guards or louvers, or by a field installed screening fence. Note that the fence must allow free flow of air to the condenser coil for proper unit operation. Upper wire mesh coil guards are standard.

Mounting Hole Access

The inside of the base rail is open to allow access for securing mounting bolts, etc. Mounting location dimensions are given in Dimensional Drawings beginning on [page 42](#).

Service Access

The control panels are located on the end of the chiller and require a minimum of four feet of clearance in front of the panels. Compressors, filter-driers, and manual liquid line shutoff valves are accessible on each side or end of the unit. The evaporator heater is located on the barrel. Do not block access to the sides or ends of the unit with piping or conduit. These areas must be open for service access. Minimum service clearance spacing on one side of the unit should be increased to 8 feet to allow for coil removal, see [Figure 5](#). The condenser fans and motors can be removed from the top of the unit. The complete fan/motor assembly can be removed for service. The fan blade must be removed for access to wiring terminals at the top of the motor.

⚠ DANGER

Disconnect, lockout and tag all power to the unit before servicing condenser fan motors or compressors. Failure to do so can cause bodily injury or death.

Figure 4: Air Flow

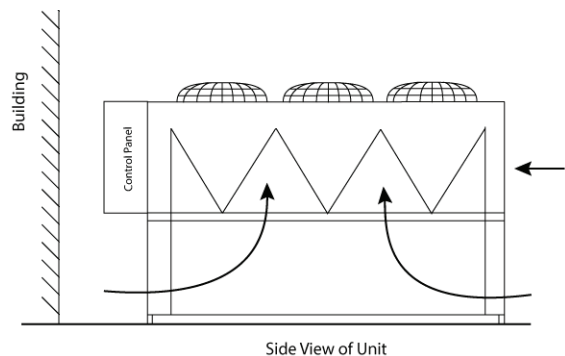

Clearance Requirements

Sufficient clearance must be maintained between the unit and adjacent walls or other units to allow the required unit air flow to reach the coils, see [Figure 4](#) and [Figure 5](#). Failure to do so will result in a capacity reduction and an increase in power consumption. Graphs on the following pages give the minimum clearance for different types of installations and also capacity reduction and power increase if closer spacing is used. The graphs are based on individual cases and should not be combined with other scenarios.

The clearance requirements shown are a general guideline, based on individual cases, and cannot account for all scenarios. Such factors as prevailing winds, additional equipment within the space, design outdoor air temperature, and numerous other factors may require more clearance than what is shown. Additional clearances may be required under certain circumstances. No solid obstructions are allowed above the unit at any height, see [Case 5](#) on [page 15](#). If low ambient temperature operation is expected, optional louvers should be installed if the unit has no protection against prevailing winds.

Figure 5: Spacing Guidelines for Sufficient Airflow

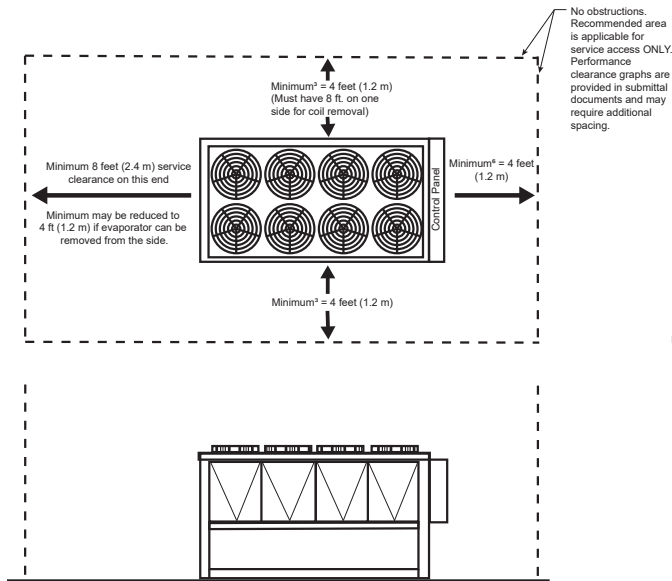

- NOTE:**
1. There should be no obstruction above the fan deck to interfere with fan discharge.
 2. Electrical conduit and field installed electrical devices should not block service access to any chiller components.
 3. Integrated Waterside Economizer (IWSE) units need a minimum side clearance of 5 ft (1.5 m) as measured from the outer base rail of the unit.
 4. For installations of 2 or more units, refer to Case 2 and Case 3.
 5. Stated spacing guidelines are for achieving sufficient airflow without incurring performance losses. See Cases 1 of 5 for capacity reduction and power increases when sufficient airflow cannot be achieved.
 6. Ensure all local and national building code requirements are met.

Case 1: Building or Wall on One Side of Unit

For most models, maintain a 4 foot minimum from a wall of any height; however, performance may be affected at this distance due to air recirculation and elevated condenser pressure. Assuming all service clearance requirements are met, Figure 7 to Figure 11 depict Case 1 performance adjustments as the wall height and distance increases. For AWV models with IWSE option, the minimum distance from a wall of any height is 5 feet as measured from the outer base rail of the unit and performance adjustments are represented in Figure 12 to Figure 15.

Figure 6: Building or Wall on One Side of Unit

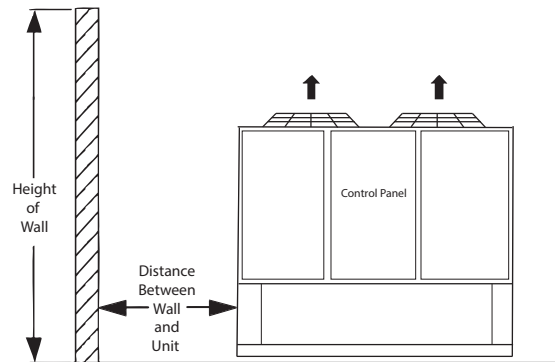

Figure 7: Case 1 for AWV 008-010 Models

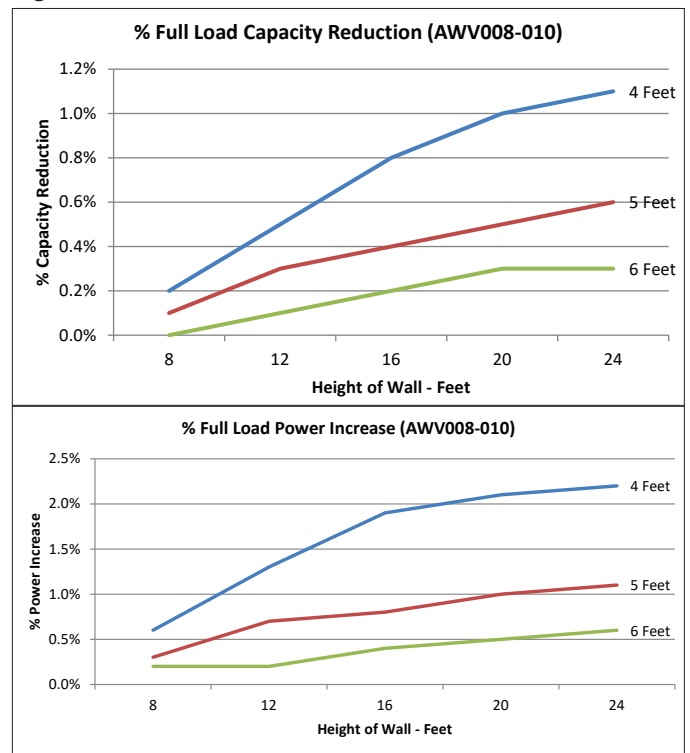

Figure 8: Case 1 for AWW012-014 Models

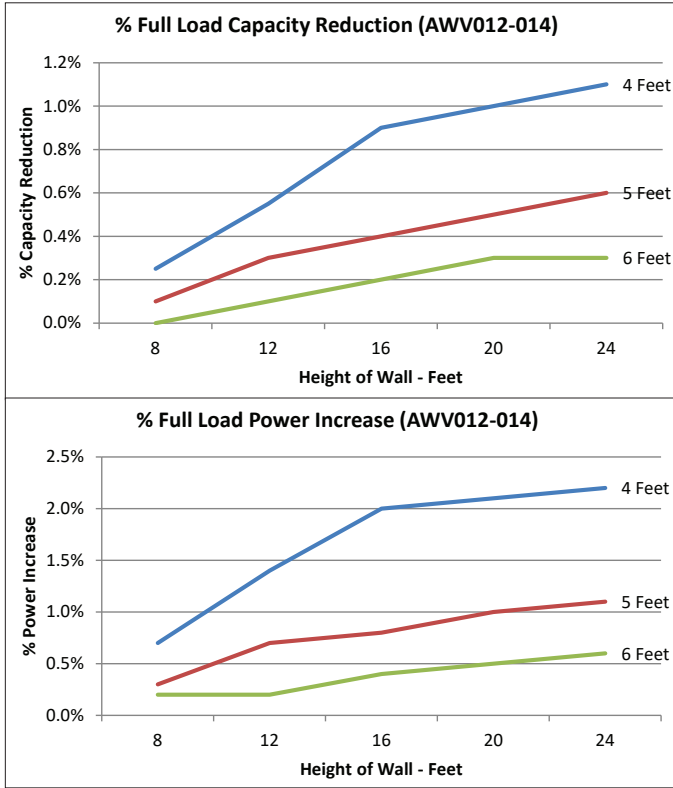

Figure 10: Case 1 for AWW020-024 Models

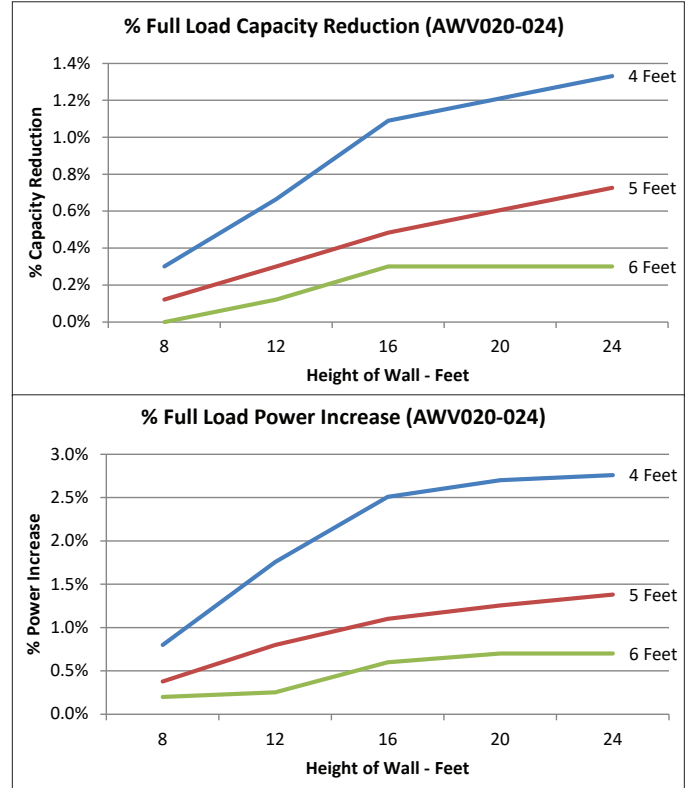

Figure 9: Case 1 for AWW016-018 Models

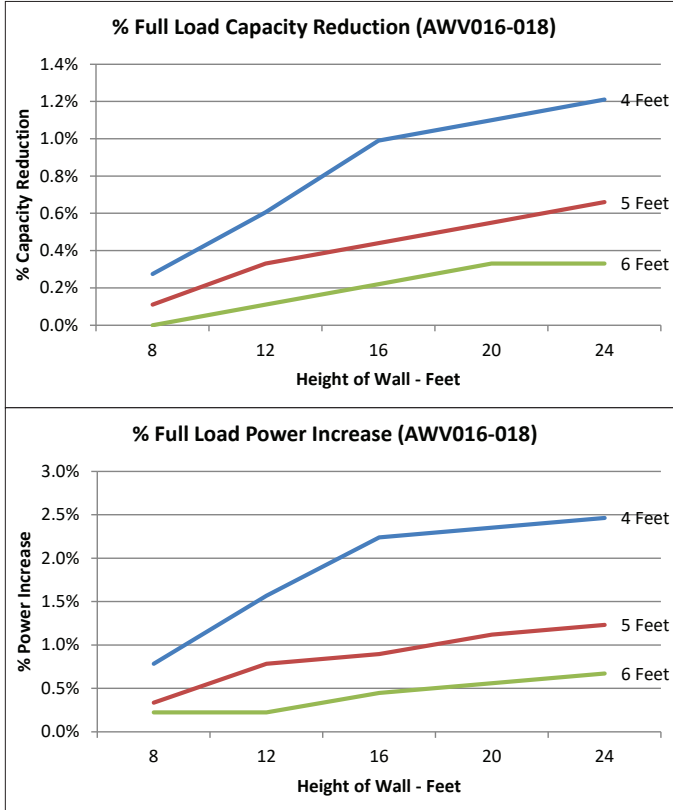

Figure 11: Case 1 for AWW026-030 Models

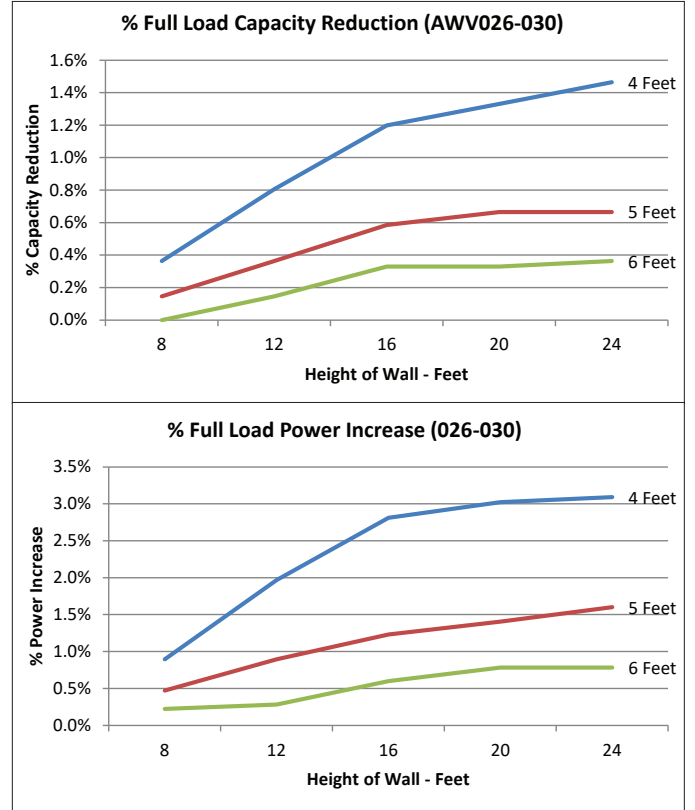

Figure 12: Case 1 for AWW 012-014 Models - IWSE Option

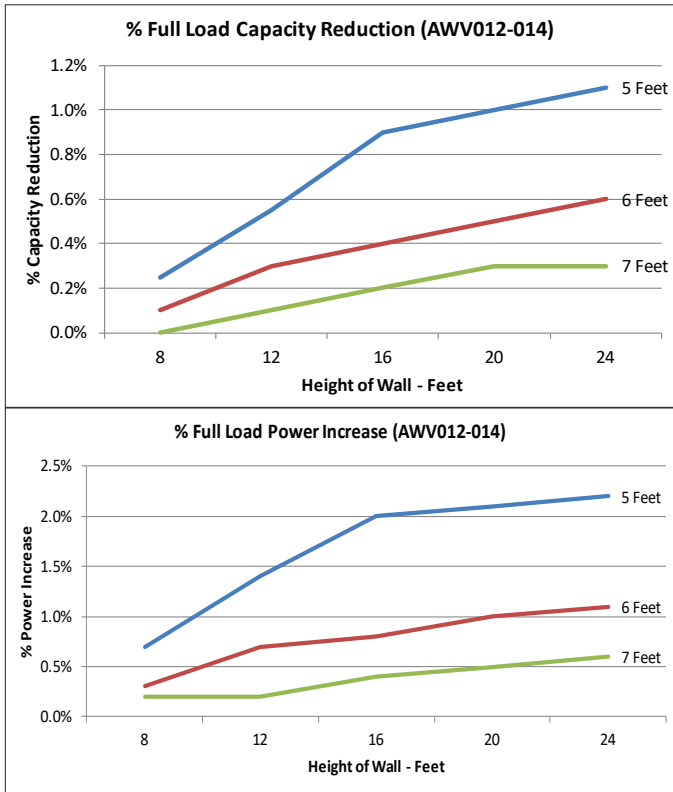

Figure 14: Case 1 for AWW 020-024 Models - IWSE Option

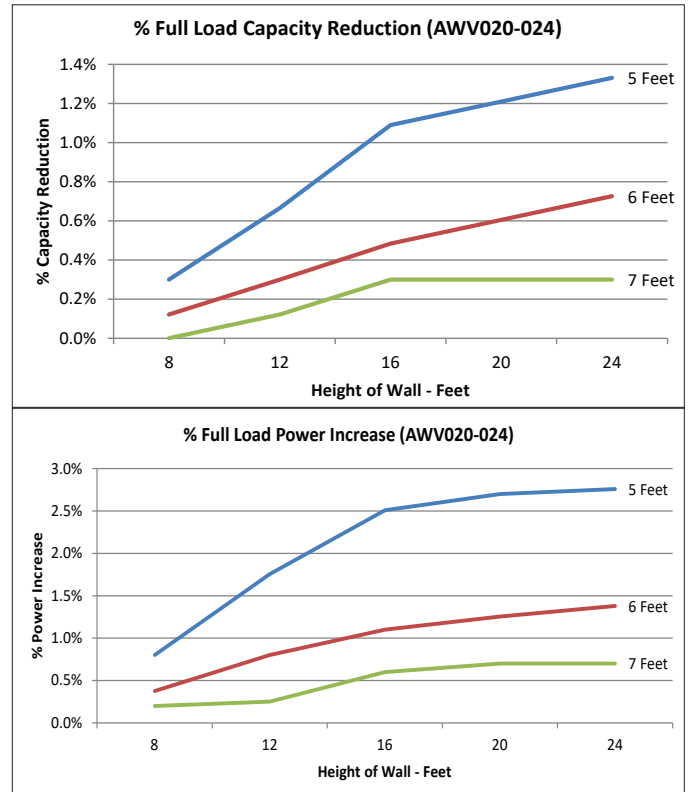

Figure 13: Case 1 for AWW 016-018 Models - IWSE Option

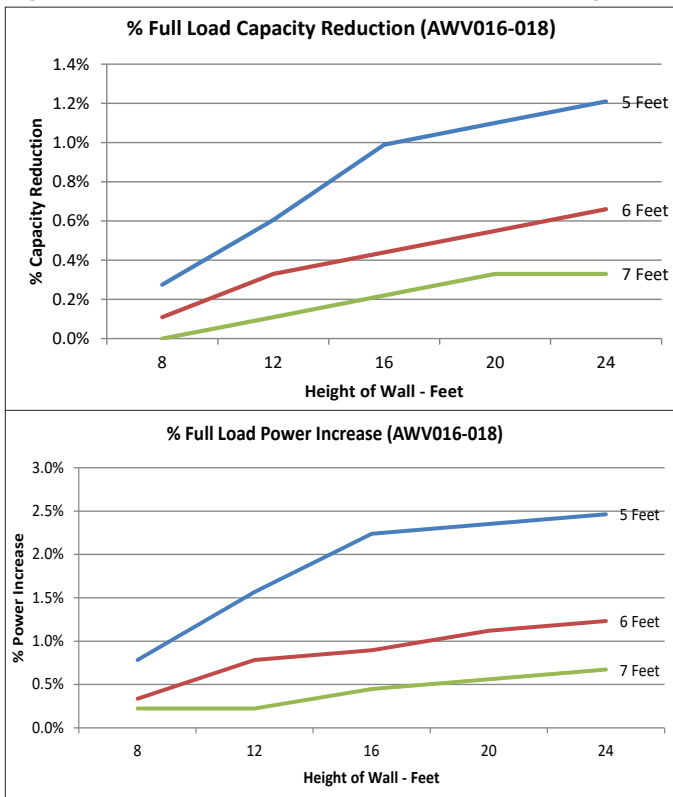
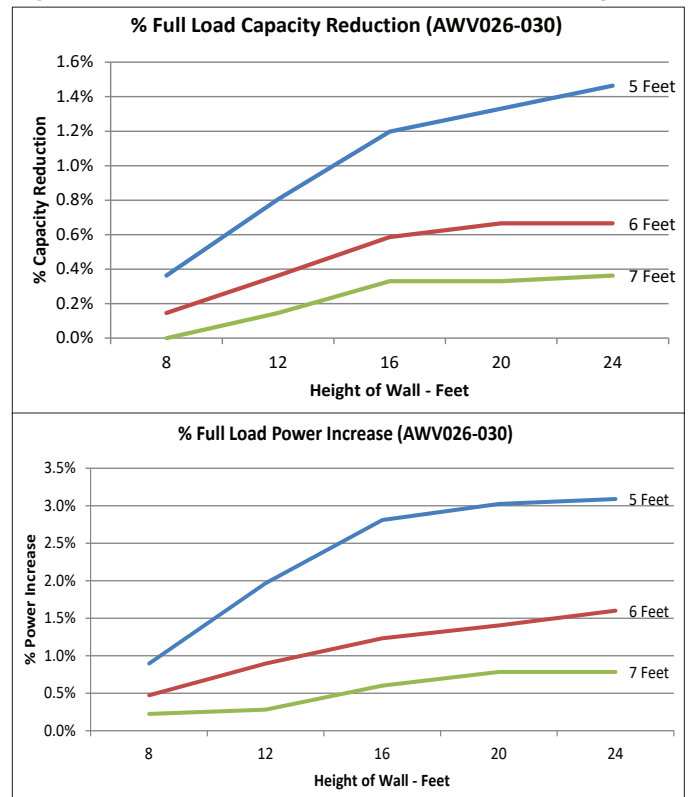

Figure 15: Case 1 for AWW 026-030 Models - IWSE Option



Case 2: Two Units Side-by-Side

For most models, there must be a minimum of 6 feet between two units placed side-by-side; however, performance may be affected at this distance due to air recirculation and elevated condenser pressure. Assuming all service clearance requirements are met, Figure 16 and Figure 17 depict Case 2 performance adjustments as the distance between two units increases. For AWW models with IWSE option, the minimum distance between two units side-by-side is 8 feet as measured from the outer base rail of the unit and performance adjustments are represented in Figure 19 and Figure 20.

Figure 18: Two Units, Side-by-Side

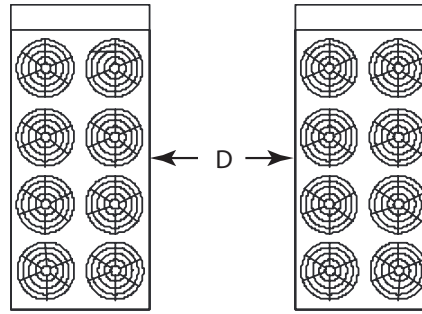

Figure 16: Case 2 - Full Load Capacity Reduction

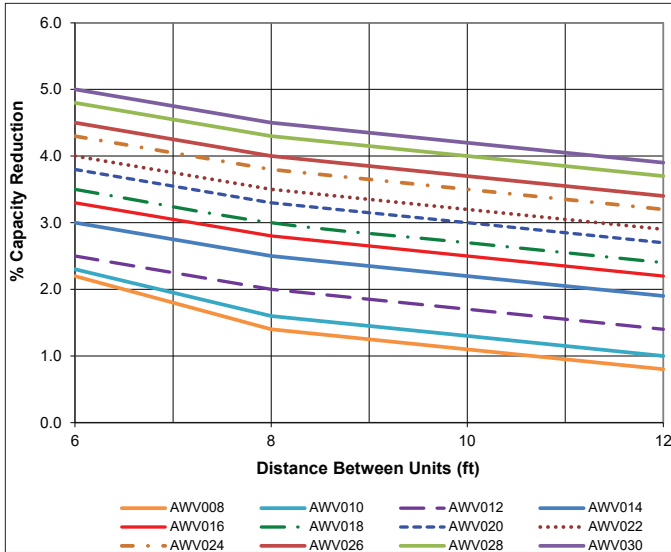

Figure 19: Case 2 - Full Load Capacity Reduction - IWSE Option

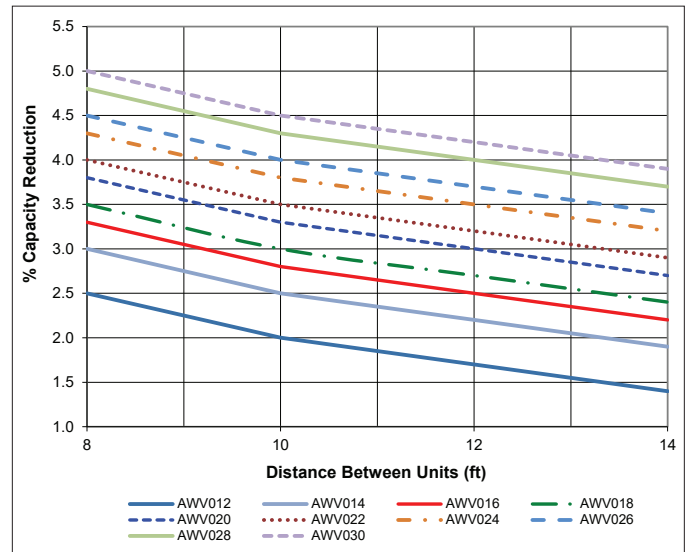

Figure 17: Case 2 - Power Increase

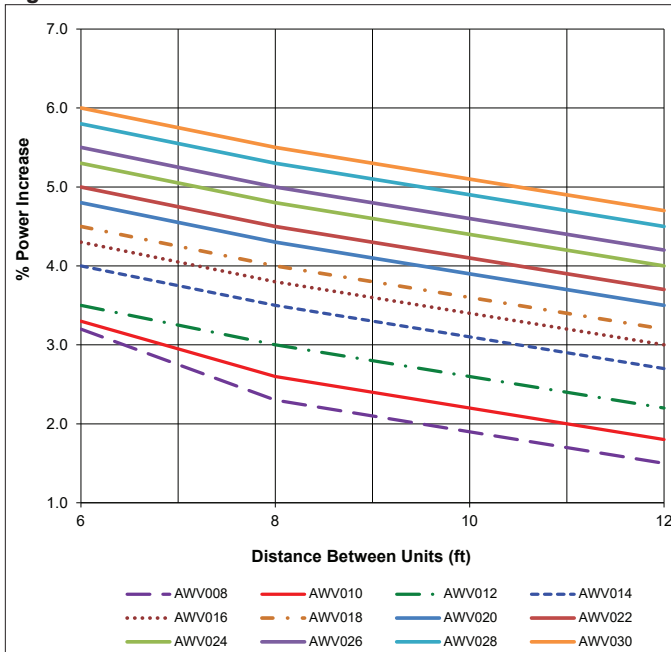
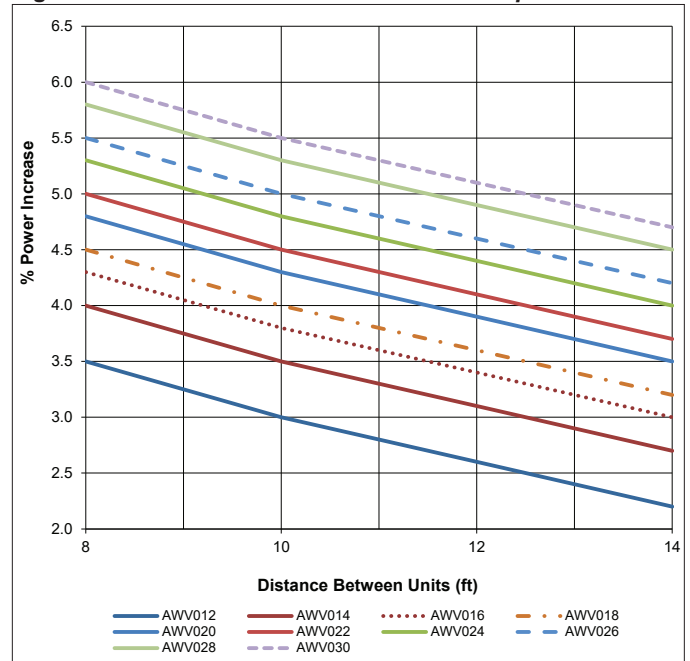

Figure 20: Case 2 - Power Increase - IWSE Option



Case 3: Three or More Units, Side-by-Side

For most models, there must be a minimum of 8 feet between any units placed side-by-side; however, performance may be affected at this distance. Figure 22 and Figure 23 depict Case 3 performance adjustments as the distance between units increases. For AWW models with IWSE option, the minimum distance between multiple units is 10 feet as measured from the outer base rail of the unit and performance adjustments are represented in Figure 24 and Figure 25.

NOTE: Data in Figure 22 to Figure 25 is for the middle unit with a unit on each side. See Case 2 adjustment factors for the two outside units.

Figure 21: Three or More Units, Side-by-Side

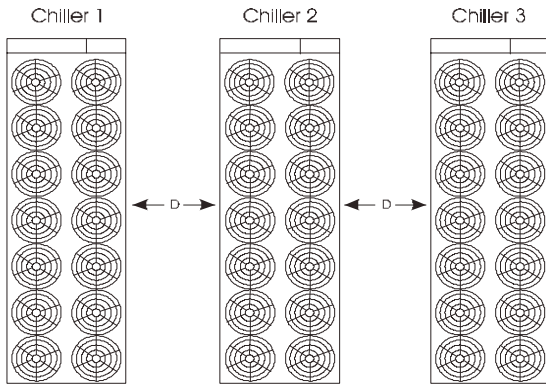

Figure 22: Case 3 - Full Load Capacity Reduction

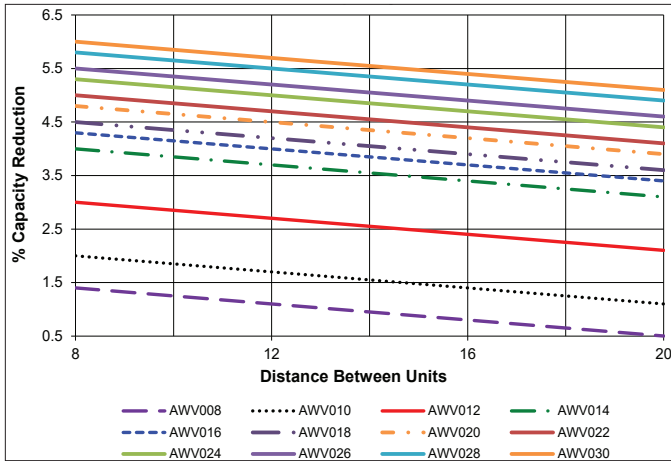

Figure 23: Case 3 - Power Increase

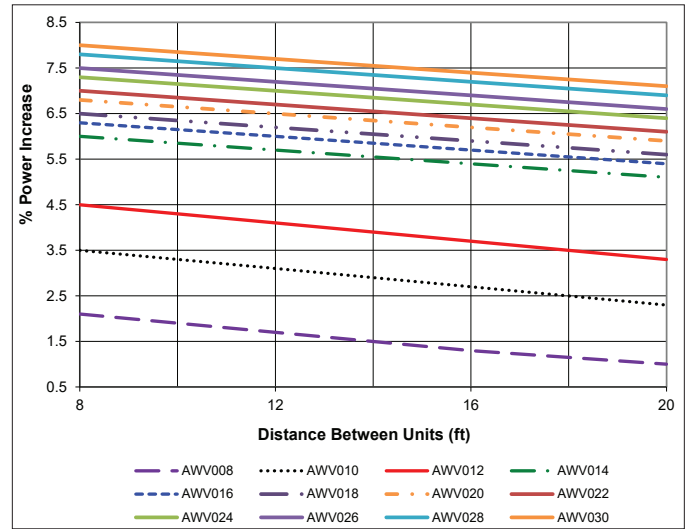

Figure 24: Case 3 - Full Load Capacity Reduction - IWSE Option

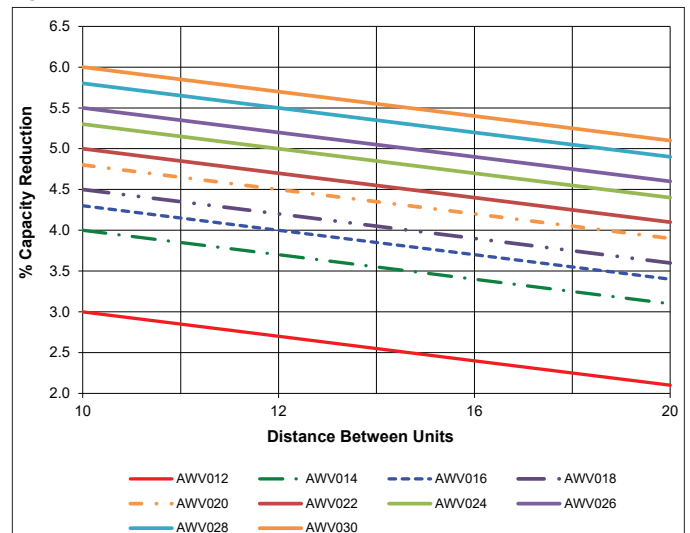
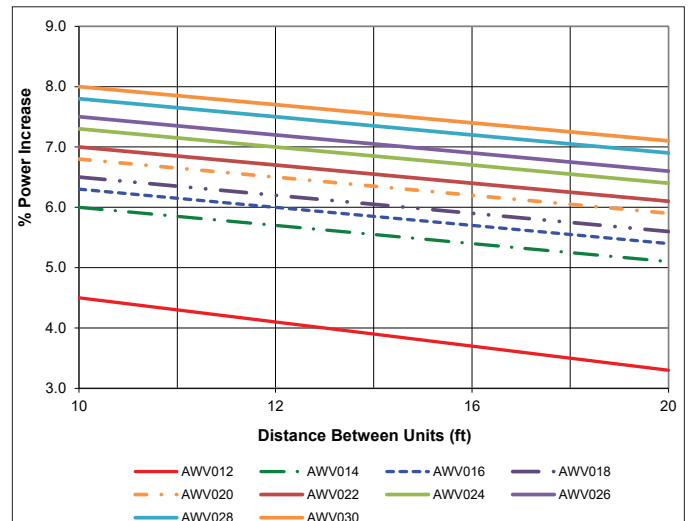

Figure 25: Case 3 - Power Increase - IWSE Option



Case 4: Open Screening Walls

Decorative screening walls are often used to help conceal a unit either on grade or on a rooftop. When possible, design these walls such that the combination of their open area and distance from the unit (see Figure 26) do not require performance adjustment. If the wall opening percentage is less than recommended for the distance to the unit, it should be considered as a solid wall. It is assumed that the wall height is equal to or less than the unit height when mounted on its base support. If the wall height is greater than the unit height, see Case 5: Pit/Solid Wall Installation. The distance from the sides of the unit to the side walls must be sufficient for service, such as opening control panel doors. For uneven wall spacing, the distance from the unit to each wall can be averaged providing no distance is less than 4 feet for most models and 5 feet as measured from the outer base rail of the unit for IWSE models. Values are based on walls on all four sides.

Figure 26: Allowable Wall Open Area

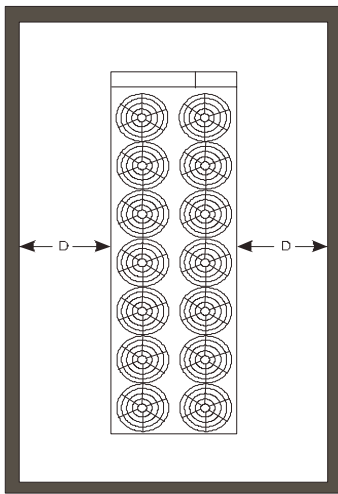

Figure 27: Case 4 - Adjustment Factor

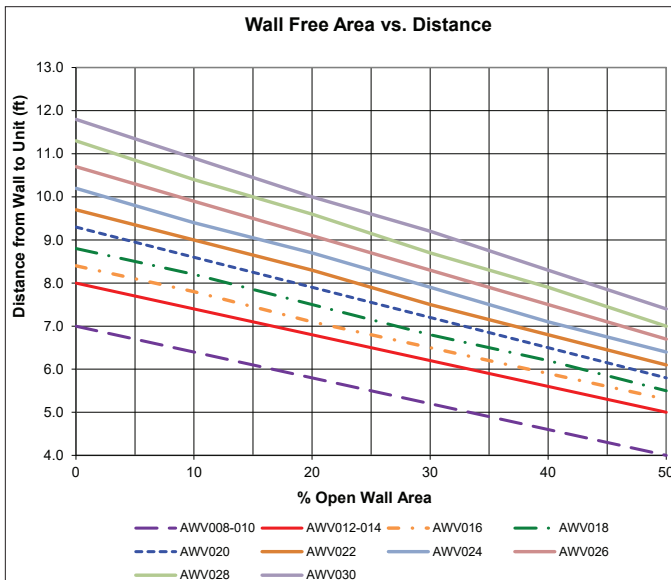
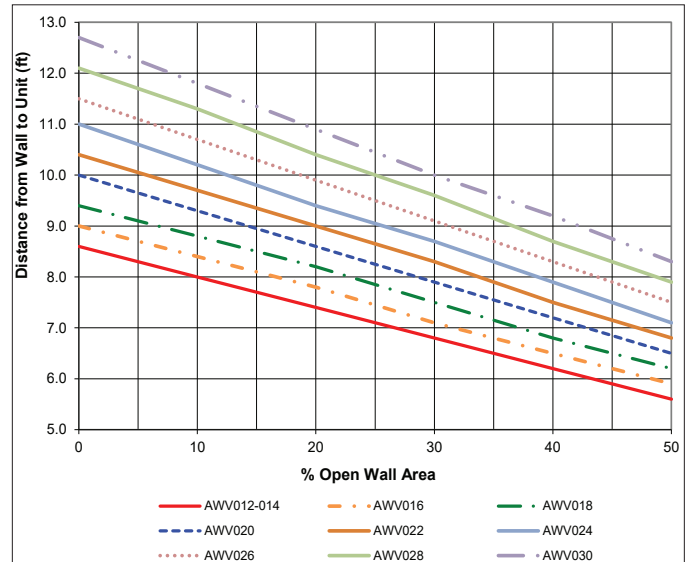

Figure 28: Case 4 - Adjustment Factor - IWSE Option



Case 5: Pit/Solid Wall Installation

Pit installations can cause operating problems resulting from air recirculation and restriction and require care that sufficient air clearance is provided, safety requirements are met and service access is provided. A solid wall surrounding a unit is substantially a pit and this data should be used. Derates are based on single chiller installation only. For IWSE chillers, distances are measured from the outer base rail of the unit.

Steel grating is sometimes used to cover a pit to prevent accidental falls or trips into the pit. The grating material and installation design must be strong enough to prevent such accidents, yet provide abundant open area to avoid recirculation problems. Have any pit installation reviewed by the Daikin Applied sales representative prior to installation to ensure it has sufficient air-flow characteristics and approved by the installation design engineer to avoid risk of accident.

Figure 29: Pit Installation

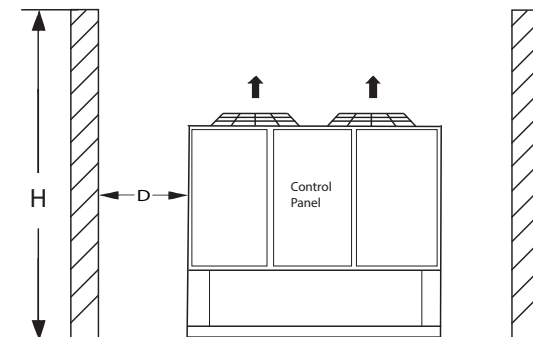

Figure 30: Case 5 for AWW008-010

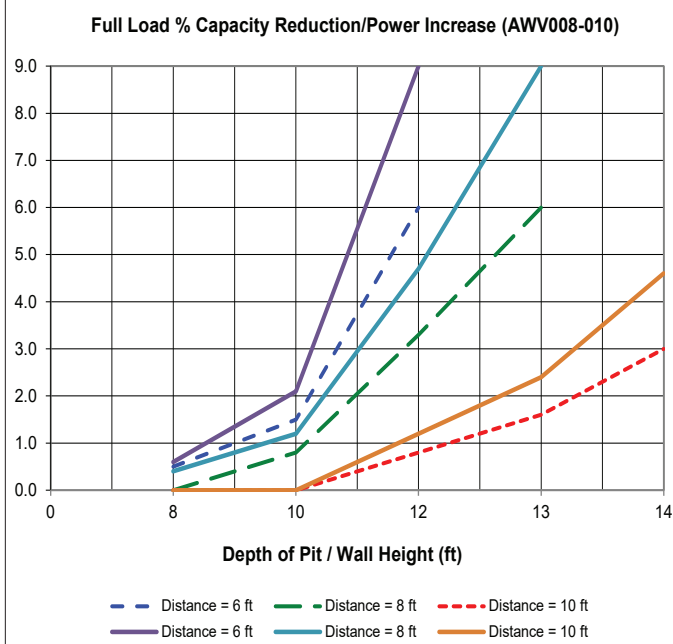

Figure 32: Case 5 for AWW016-018

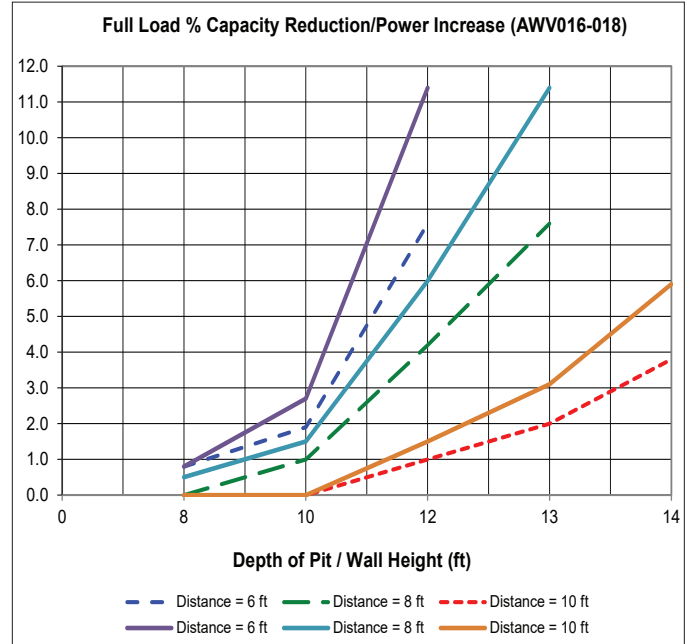

Figure 31: Case 5 for AWW012-014

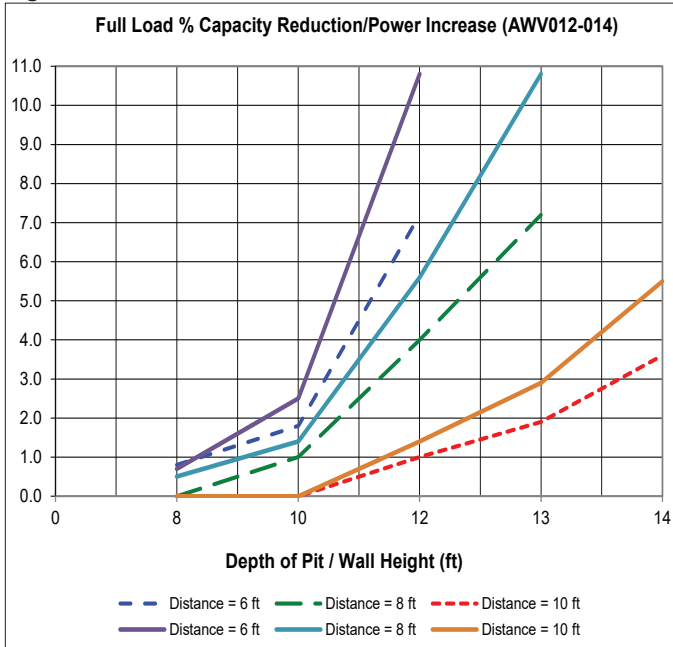

Figure 33: Case 5 for AWW020-024

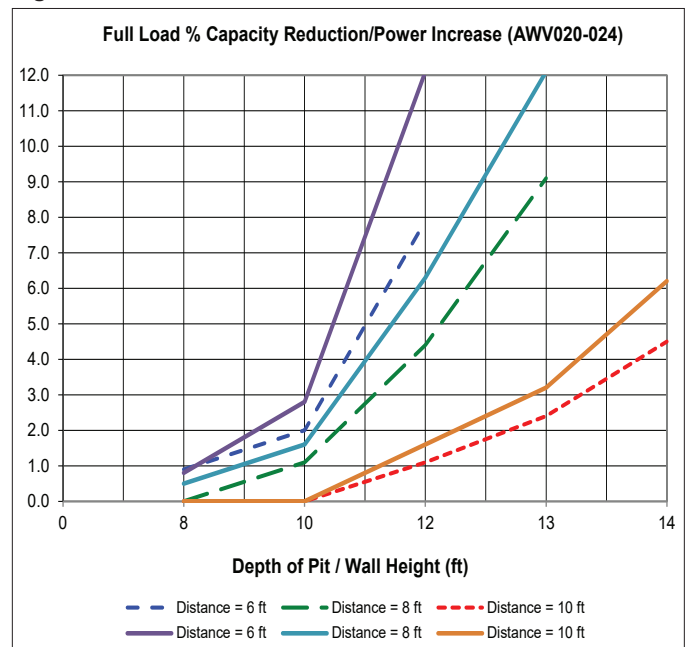

Figure 34: Case 5 for AWW026-030

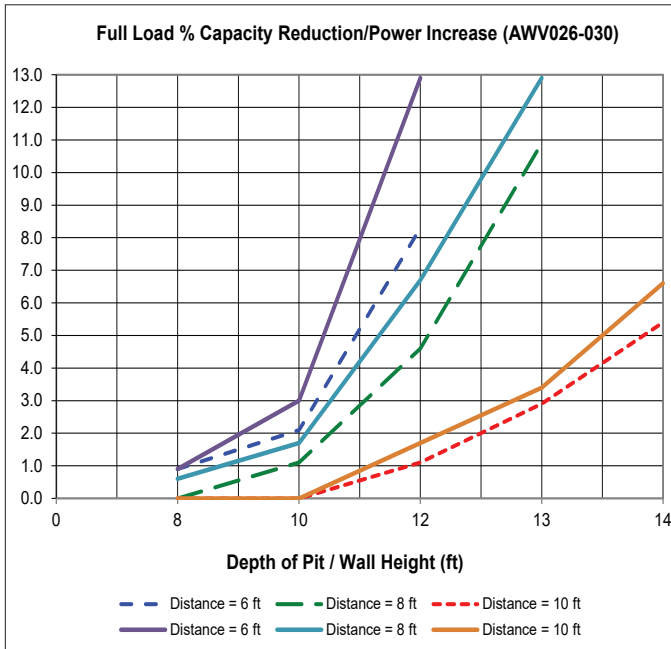

Figure 36: Case 5 for AWW016-018 - IWSE Option

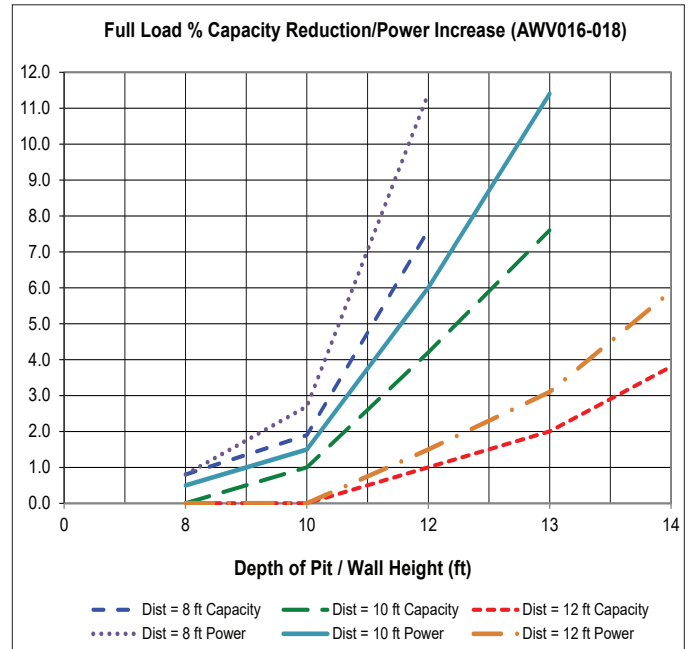

Figure 35: Case 5 for AWW012-014 - IWSE Option

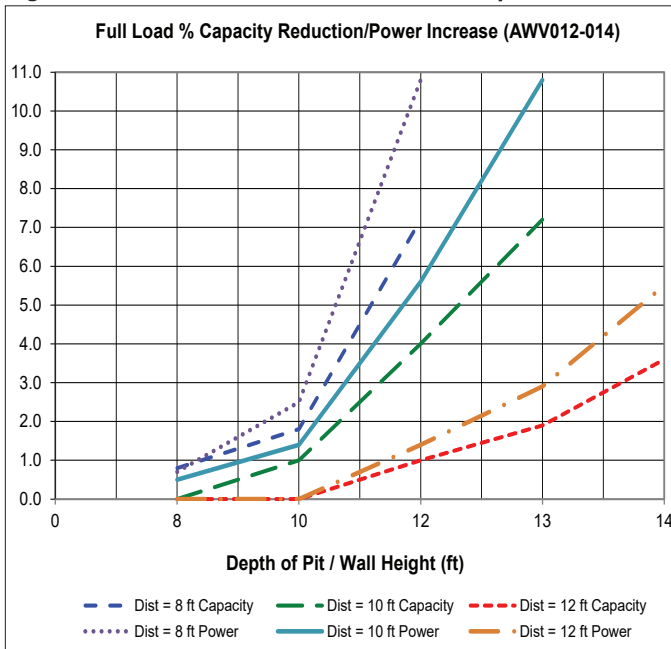

Figure 37: Case 5 for AWW020-024 - IWSE Option

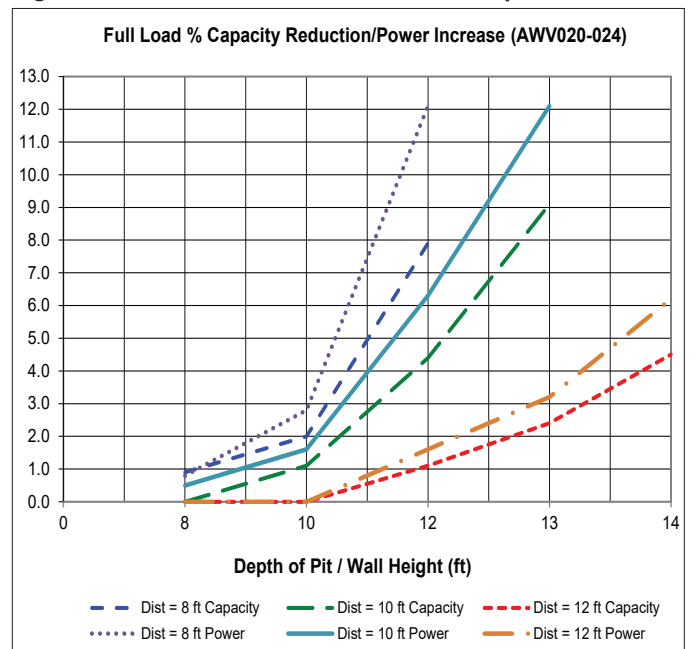
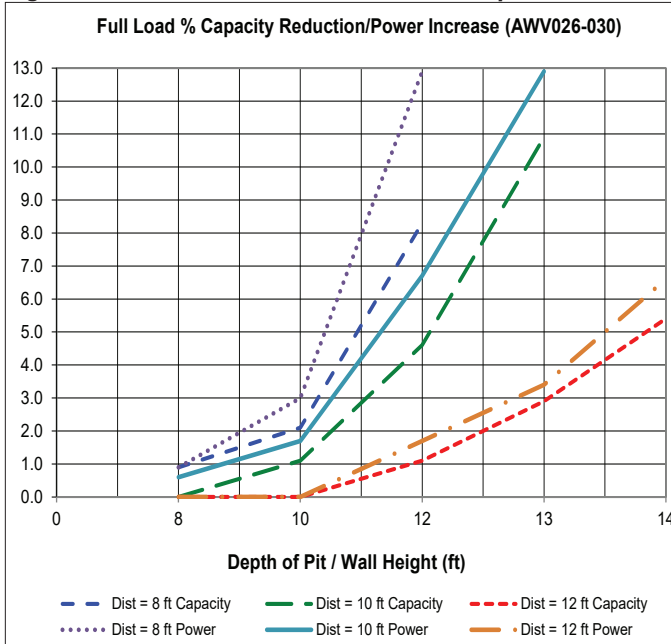

Figure 38: Case 5 for AWW026-030 - IWSE Option



Chilled Water Piping

Startup procedures should confirm that the chilled water piping system had been properly flushed out before being connected to the chiller vessel.

All evaporators have OGS-type grooved water connections (adhering to Standard AWWA C606) or optional flange connections. The installing contractor must provide matching mechanical connections. Be sure water inlet and outlet connections match certified drawings and nozzle markings. PVC and CPVC piping should not be used.

WARNING

Polyolester Oil, commonly known as POE oil is a synthetic oil used in many refrigeration systems, and is present in this Daikin Applied product. POE oil, if ever in contact with PVC/CPVC, will coat the inside wall of PVC/CPVC pipe causing environmental stress fractures. Although there is no PVC/CPVC piping in this product, please keep this in mind when selecting piping materials for your application, as system failure and property damage could result. Refer to the pipe manufacturer's recommendations to determine suitable applications of the pipe.

CAUTION

To prevent damage to the evaporator and potential chiller failure, a supply strainer is required in the inlet water piping which connects to the evaporator. This strainer must be installed prior to operation of the chilled liquid pumps.

Field installed water piping to the chiller must include:

- A cleanable strainer installed at the water inlet to the evaporator or IWSE connection to remove debris and impurities before they reach the evaporator. Install

cleanable strainer within 5 feet (1500 mm) of pipe length from the evaporator inlet connection and downstream of any welded connections (no welded connections between strainer and evaporator). AWW models require a strainer as specified in Inlet Strainer Guidelines on page 18.

- A water flow switch must be installed in the horizontal piping of the supply (evaporator outlet) water line to avoid evaporator freeze-up under low or no flow conditions. See page 21 for more information.

NOTE: Units with the optional pump package include the strainer and flow switch. See page 42 for pump package components.

- Purge air from the water system before unit startup to provide adequate flow through the evaporator.
- Piping for units with brazed plate evaporators must have a drain and vent connection provided in the bottom of the lower connection pipe and to the top of the upper connection pipe. These evaporators do not have drain or vent connections due to their construction.
- Adequate piping support, independent from the unit, to eliminate weight and strain on the fittings and connections.

It is **recommended** that the field installed water piping to the chiller include:

- Thermometers at the inlet and outlet connections of the evaporator.
- Water pressure gauge connection taps and gauges at the inlet and outlet connections of the evaporator for measuring water pressure drop.
- Shutoff valves to isolate the unit from the piping during unit servicing.
- Minimum bends and changes in elevation to minimize pressure drop.
- An expansion tank and regulating valve to maintain adequate water pressure. Tank becomes required for closed loop systems based on water volume and temperature ranges.
- Vibration eliminators in both the supply and return water lines to reduce transmissions to the building.
- Flushing the system water piping thoroughly **before** making connections to the unit evaporator.
- Piping insulation, including a vapor barrier, helps prevent condensation and reduces heat loss.
- Regular water analysis and chemical water treatment for the evaporator loop is recommended immediately at equipment startup.

Inlet Strainer Guidelines

An inlet water strainer kit must be installed in the chilled water piping within 5 feet of the evaporator inlet or IWSE connection. Two paths are available to meet this requirement:

1. A field-installed kit shipped loose with the unit is available for all unit sizes and consists of:
 - Y-type area strainer with 304 stainless steel perforated

- basket, Grooved pipe connections and strainer cap
- a strainer with perforations no larger than 0.031" (1/32", 0.8 mm) diameter for AWV models with the IWSE option along with a gasket and bolts...see [Figure 39](#) for installation
 - a strainer with perforations no larger than 0.063" (1/16", 1.6 mm) diameter for AWV models with a braze plate evaporator
 - a strainer with perforations no larger than 0.125" (1/8", 3.2 mm) diameter for AWV models with a direct expansion evaporator
- Extension pipe with two couplings that may be used for gauges and sensors. The pipe provides sufficient clearance from the evaporator for strainer basket removal (non-IWSE configurations)
 - ½-inch blowdown valve (non-IWSE configurations)
 - Two grooved clamps (non-IWSE configurations)

The strainer is sized per [Table 2](#). Connection sizes are given in the Pressure Drop Data section on [page 46](#).

2. All units with the pump package option include a strainer shipped loose for field mounting.
3. A field-supplied strainer to same specifications as factory installed option.

Table 2: Strainer Sizing Data

Application	Strainer Size (in.)	Maximum Perforation Size in. (mm)	Strainer Weight (lbs)
IWSE	6	0.031" (1/32", 0.8 mm)	154
	8		273
	10		464
Braze Plate Evap	6	0.063" (1/16", 1.6 mm)	120
Shell and Tube Evap	6	0.125" (1/8", 3.2 mm)	120
	8		220
	10		514

Installing Inlet Strainer (Field-installed Kit)

The strainer must be mounted per manufacturer’s instruction with the arrows in the direction of flow; inlet and outlet are noted along with the arrows. The piping and strainer must be supported to prevent any stress on the evaporator nozzle.

Non-IWSE units - The extension pipe is only for non-IWSE units and is located adjacent to the evaporator with the strainer then mounted to it. Use one grooved clamp to mount the extension pipe to the evaporator and the second to mount the strainer to the pipe. The clamps to mount the field piping to the strainer are field supplied.

IWSE Units - Place the supplied gasket between the gasket seating surface of the inlet IWSE pipe and the strainer flange as shown in [Figure 39](#). Secure with provided bolts and nuts.

Figure 39: IWSE Gasket Connection to Strainer

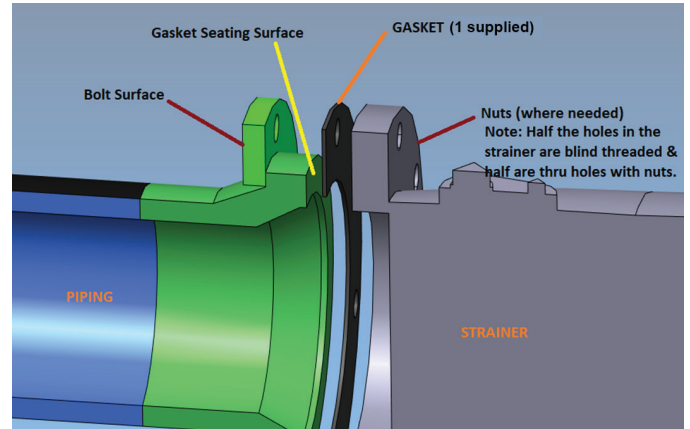

System Water Volume

All chilled water systems need adequate time to recognize a load change, respond to that load change and stabilize, without undesirable short cycling of the compressors or loss of control. In air conditioning systems, the potential for short cycling usually exists when the building load falls below the minimum chiller plant capacity or on close-coupled systems with very small water volumes. Some of the things the designer should consider when looking at water volume are the minimum cooling load, the minimum chiller plant capacity during the low load period and the desired cycle time for the compressors.

Figure 40: Typical Chilled Water Piping, Braze Plate

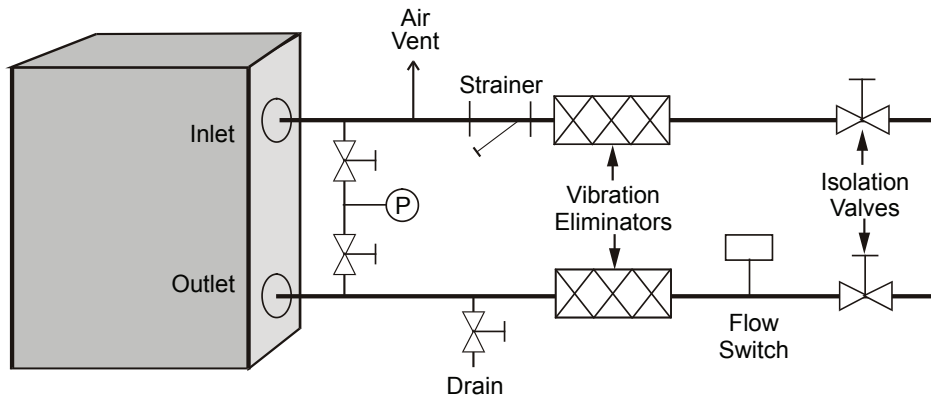

WELDED PIPE CONNECTIONS ARE NOT ALLOWED BETWEEN THE STRAINER AND EVAPORATOR DUE TO THE CHANCE OF SLAG ENTERING THE EVAPORATOR

Figure 41: Typical Chilled Water Piping, Shell and Tube Evaporator

NOTE: WATER INLET CONNECTION IS CLOSEST TO THE COMPRESSOR SUCTION LINE

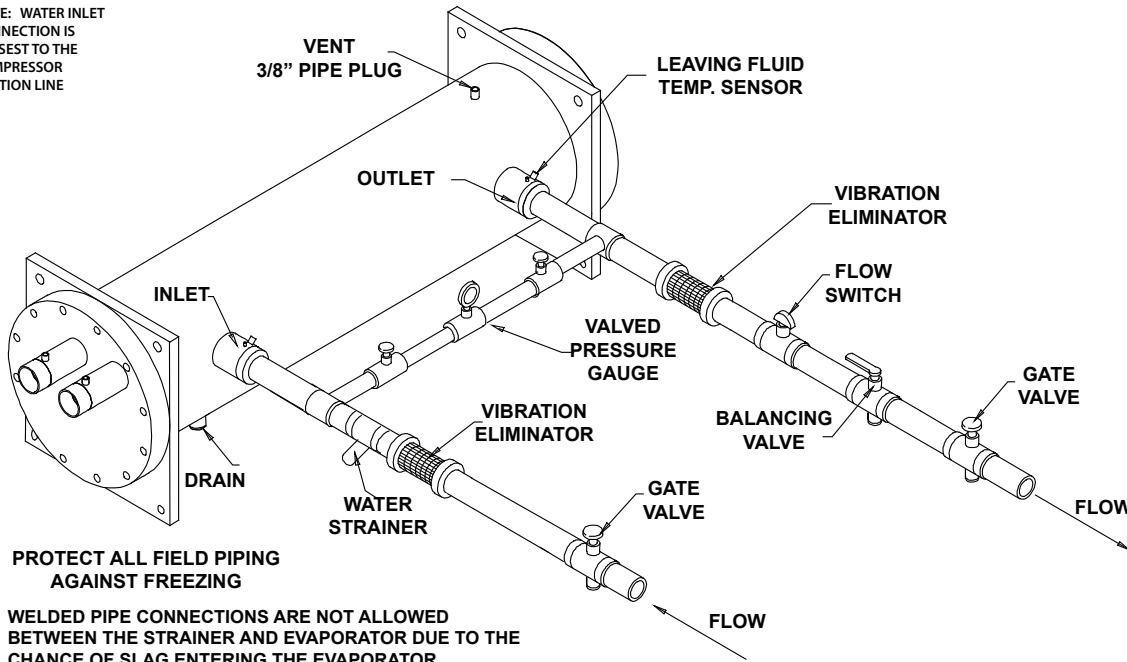

PROTECT ALL FIELD PIPING AGAINST FREEZING

WELDED PIPE CONNECTIONS ARE NOT ALLOWED BETWEEN THE STRAINER AND EVAPORATOR DUE TO THE CHANCE OF SLAG ENTERING THE EVAPORATOR

Assuming there are no sudden load changes and the chiller plant has reasonable turndown, a rule of thumb of “gallons of water volume equal to two to three times the chilled water gpm flow rate” is often used. A storage tank may have to be added to the system to reach the recommended system volume. Refer to Daikin Applied Chiller Application Guide, AG 31-003, for method of calculating “Minimum Chilled Water Volume”.

The water quality provided by the owner/occupant/operator/user to a chiller system should minimize corrosion, scale buildup, erosion, and biological growth for optimum efficiency of HVAC equipment without creating a hazard to operating personnel or the environment.

Strainers must be used to protect the chiller systems from water-borne debris. Daikin Applied will not be responsible for any water-borne debris damage or water side damage to the

chiller heat exchangers due to improperly treated water.

Water systems should be cleaned and flushed **prior** to chiller installation. Water testing and treatment should be verified during initial chiller installation/commissioning and maintained on a continuous basis by water treatment professionals (see Limited Product Warranty).

<p>⚠ CAUTION</p>
<p>The improper use of detergents, chemicals, and additives in the chiller system water may adversely affect chiller performance and potentially lead to repair costs not covered by warranty. Any decision to use these products is at the discretion of the owner/occupant/operator/user as such they assume full liability/responsibility for any damage that may occur due to their use.</p>

Flow Switch

A flow switch must be included in the chilled water system to prove that there is adequate water flow to the evaporator before the unit can start, or to shut down the unit if water flow is interrupted. A factory-included thermal dispersion flow switch will be installed on packaged models. On remote evaporator models, the flow switch may be separately field-provided, or optionally shipped loose for field installation.

Installation should be per manufacturer's instructions included with the switch. Flow switches should be calibrated to shut off the unit when operated below the minimum flow rate for the unit. Flow switch installation and calibration is further discussed on [page 97](#).

NOTE: All units with a pump package option include a flow switch.

Evaporator Freeze Protection

Evaporator freeze-up can be a concern in the application of air-cooled water chillers in areas experiencing below freezing temperatures. To protect against freeze-up, insulation and an electric immersion heater are furnished with the evaporator. This helps protect the evaporator down to -20°F (-29°C) ambient air temperature. Although the evaporator is equipped with freeze protection, it does not protect water piping external to the unit or the evaporator itself if there is a power failure or heater burnout, or if the chiller is unable to control the chilled water pumps. Use one of the following recommendations for additional protection:

- If the unit will not be operated during the winter, drain evaporator and chilled water piping and flush with glycol. Drain and vent connections are provided on the evaporator for this purpose.
- Add a year-round glycol solution to the chilled water system to provide freeze protection. Freeze point should be approximately 10°F (5.6°C) below minimum design ambient temperature or 10°F (5.6°C) below the lowest design leaving water temperature, whichever is lower. The use of glycol antifreeze is generally considered the safest protection against freeze-up; however, it will reduce the performance of the unit, depending on the concentration. Take this into consideration during initial system design and selection. On glycol applications, a minimum fluid concentration should be based on Burst Protection limits.
- The field addition of thermostatically controlled heat tracing and insulation to exposed piping, dependent on power availability.
- Continuous circulation of water through the chilled water piping and evaporator, with ability to control temperature within chiller safety limits. (Dependent on power availability).
- The evaporator immersion heater is factory-wired to the 115-volt circuit in the control box. This power can be supplied from a separate source, or it can be supplied from the control circuit. Operation of the heater cable

is automatic through the fluid sensing thermostat that energizes the evaporator heater cable for protection against freeze-up. Unless the evaporator is drained in the winter, the disconnect switch to the evaporator heater must be closed. Conversely, do not apply heat to the evaporator if it is drained.

Chilled Water Pump

It is important that the chilled water pumps be wired to, and controlled by, the chiller's microprocessor. The chiller controller has the capability to selectively send the signal to a pump relay (by others) to start pump A or B or automatically alternate pump selection and also has standby operation capability. The controller will energize the pump whenever at least one circuit on the chiller is enabled to run, whether there is a call for cooling or not. This helps ensure proper unit startup sequence. To help prevent evaporator freeze-up, the pump will also be turned on when the water temperature is equal to or goes below the Freeze Set Point for at least three seconds. Connection points are shown in the Field Wiring Diagrams.

CAUTION

Adding glycol or draining the system is the recommended method of freeze protection. If the chiller does not have the ability to control the pumps and the water system is not drained in temperatures below freezing, catastrophic evaporator failure may occur.

Failure to allow pump control by the chiller may cause the following problems:

1. If any device other than the chiller attempts to start the chiller without first starting the pump, the chiller will lock out on the No Flow alarm and require manual reset.
2. If the evaporator water temperature drops below the "Freeze Set Point" the chiller will attempt to start the water pumps to avoid evaporator freeze. If the chiller does not have the ability to start the pumps, the chiller will alarm due to lack of water flow.
3. If the chiller does not have the ability to control the pumps and the water system is not to be drained in temperatures below freezing, the chiller may be subject to catastrophic evaporator failure due to freezing. The freeze rating of the evaporator is based on the immersion heater and pump operation. The immersion heater itself may not be able to properly protect the evaporator from freezing without circulation of water.

Variable Speed Pumping

Reducing evaporator flow in proportion to load can reduce system power consumption. Daikin Applied chillers are designed for variable water flow duty provided that the rate of change is less than ten percent of the design flow per minute, and the minimum and maximum flow rates for the evaporator, beginning on [page 46](#), are not exceeded. If flow drops below the minimum allowable, large reductions in heat transfer can occur. If the flow exceeds the maximum rate, excessive

pressure drop and tube erosion can occur. For example, if the maximum design flow is 200 gpm and it will be reduced to a flow of 140 gpm, the change in flow is 60 gpm. Ten percent of 200 gpm equals 20 gpm change per minute, or a minimum of three minutes to go from maximum to desired flow.

Ice Mode

Optional double evaporator insulation is recommended for ice mode operation. The standard controller software will require “ice” set point changes and a digital signal into the controller is required to change to the ice mode and back to standard cooling. See the Field Wiring Diagrams for the connection location. In ice mode, the unit will operate at full load until the shutoff temperature set point is reached.

Glycol Solutions

The installed glycol level must align with the rated glycol percentage indicated on the submitted chiller technical data sheet. Failure to adhere to the rated glycol percentage may result in unit damage and loss of unit warranty

Test fluid with a clean, accurate glycol solution hydrometer (similar to that found in service stations) or refractometer to determine the freezing point. On glycol applications, the supplier normally recommends that a minimum of 25% solution by weight be used for protection against corrosion or that additional inhibitors should be employed.

 CAUTION
Do not use automotive grade antifreeze. Industrial grade glycols must be used. Automotive antifreeze contains inhibitors that will cause plating on the copper tubes within the chiller evaporator. The type and handling of glycol used must be consistent with local codes.

Performance Adjustment Factors

AWV chillers are designed to operate with leaving antifreeze solution temperatures per software range limits. Consult the local Daikin Applied sales office for performance outside these temperatures. Leaving chilled fluid temperatures below 40°F (4.4°C) result in evaporating temperatures at or below the freezing point of water and a glycol solution is required. MicroTech unit control inhibits compressor unloading at leaving fluid temperatures below 25°F (-3.9°C).

Low fluid temperatures or high equipment room humidity for remote evaporators may require optional double evaporator insulation. The system designer should determine its necessity. The use of glycol will reduce unit performance depending on its concentration and should be considered during initial system design.

Figure 42: Integrated Waterside Economizer Option - Representative Model



Integrated Waterside Economizer

Pathfinder Model AWV chillers with an integrated system of waterside economizer coils may be able to satisfy 100% of cooling load without starting a compressor or may run in full mechanical operating mode. Figure 46 illustrates mechanical cooling only mode which would be necessary for high ambient temperatures. Cooling from the integrated waterside economizer (IWSE) coils, Figure 45, is possible when the outdoor air temperature is colder than the fluid temperature requirements. The minimum operating ambient is -20°F (-28.9°C).

The unit controller automatically adjusts two 2-way control valves to bring the IWSE coils in or out of the loop. Bypassing the IWSE coils during mechanical operation only mode avoids the additional pressure drop from the economizer coils.

Hybrid cooling mode operation further maximizes the efficiency of the system by rejecting some heat to the IWSE coils before sending the fluid to the evaporator. The mechanical cooling loop will further cool the fluid to the required setpoint but will use much less energy. Figure 43 shows how the two loops work together in hybrid cooling mode.

Figure 43: Hybrid Cooling Mode Operation

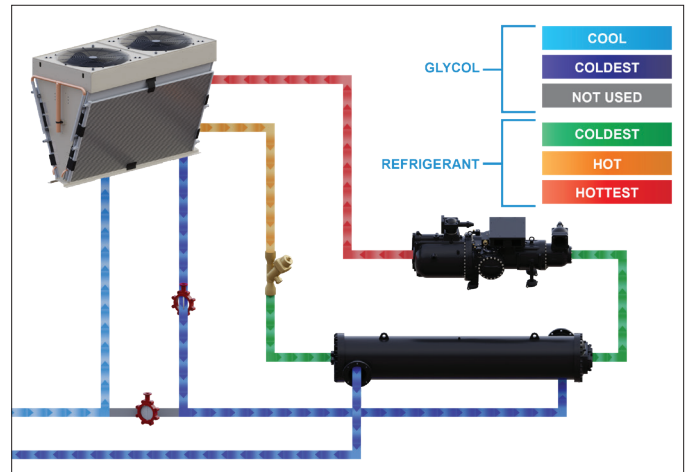

Waterside Economizer Operating Guidelines

1. **Fluid used in IWSE systems must contain glycol.**
The system glycol percentage must be high enough to avoid **burst** conditions at the lowest possible ambient temperature of the installed location, regardless of whether the unit is operating or turned off at that minimum temperature. The chiller fluid loop is required to be protected against **burst** conditions at least 5°F below minimum operating and non-operating ambient temperatures. It is recommended to protect the system against **freeze** conditions 5°F below minimum operating and non-operating ambient temperatures. Failure to ensure adequate glycol freeze protection may result in damage of the water-side economizer coils and coolant leakage from the system.
2. If the chiller is hydraulically isolated, some method of pressure relief must be added to the chiller side fluid loop such as a relief valve or expansion tank. Daikin Applied supplied relief valve kit provides relief valve with ½” female NPT connection and allows for customer to pipe to blowdown tank or other receptacle as may be required by local building codes. The system must not have quick-acting valves or other sources of surge pressure in the fluid loop.
3. Maximum flow rates must be observed to protect IWSE coils and piping; see “Pressure Drop Data” on page 46.
4. A strainer for the glycol system must meet the requirements of [See Inlet Strainer Guidelines on page 18](#).
5. Inhibitors for steel, copper, brass, and aluminum must be included for all closed water loop systems. Some glycols include inhibitors and should be considered when commissioning the water system. As water chemistry can vary, Daikin Applied recommends that a water treatment professional determine the appropriate chemical treatment and maintenance plan for the water/glycol loop to ensure the fluid is clean and non-corrosive to the materials present in the system, including but not limited to the steel, copper, and aluminum alloys in contact with the fluid.
 - The glycol system should include a biocide to protect the system against biological growth. The biocide should be non-ionic, non-foaming, and non-oxidizing.
 - Water system maximum allowable chlorides content is 25 ppm to prevent corrosion of aluminum IWSE coils.

Figure 44: Connection Ports on IWSE Piping

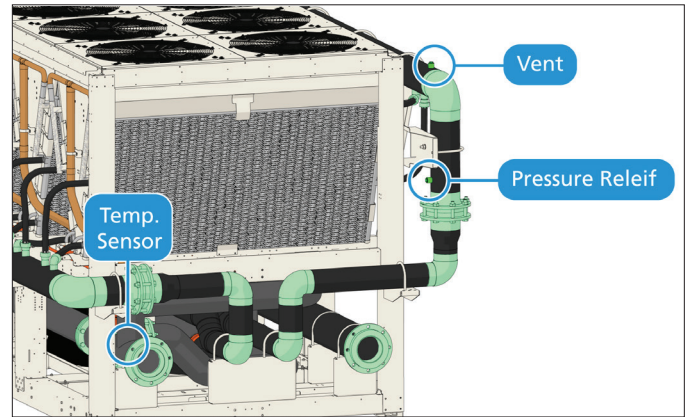

NOTE: The Temp sensor is located behind the flange and not visible in the above image.

Figure 45: Integrated Waterside Economizer Operation

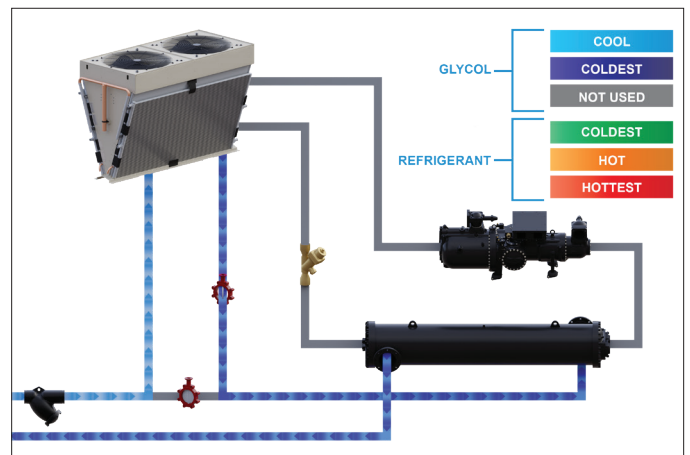
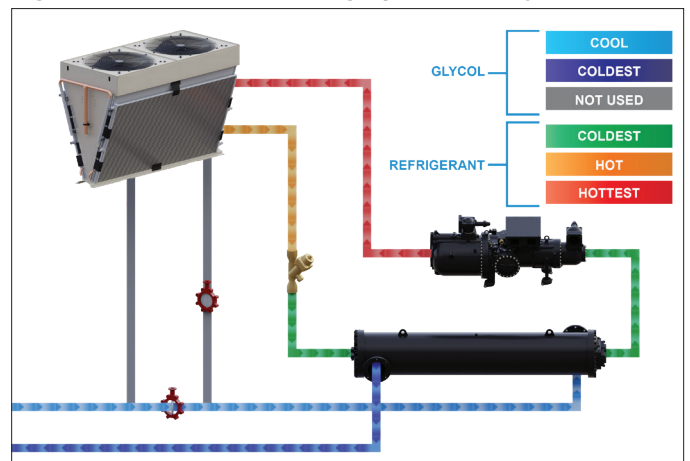

Figure 46: Mechanical Cooling Operation Only



Closed Loop Economizer

For applications which are suitable for free-cooling but prohibit glycol in the chilled-water loop, the Pathfinder AWW Free-Cooling offers an optional Closed Loop which allows the chilled water to be free of glycol. Figure 47 highlights how the closed loop design provides a water-side economizer which is independent of the evaporator by providing additional components such as an intermediate heat exchanger, circulating pump, and actuating valves. The waterside economizer operating guidelines 1 through 5 as stated above are still applicable for the waterside economizer side. However, with the closed loop option the chilled water can be free of glycol.

Figure 47: Closed Loop Economizer

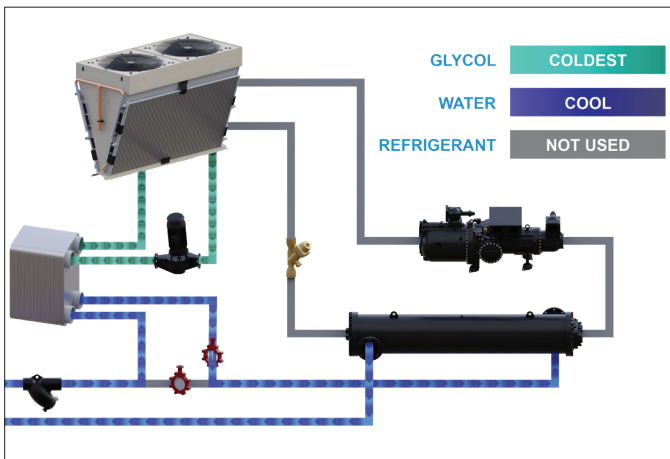

Electrical Connections

Pathfinder units can be ordered with either standard multi-point power or optional single point power connections and with various disconnect and circuit breaker options. Power wiring connections to the chiller may be done with either copper or aluminum selected conductors, provided they fit the chiller lugs. All wiring must be done in accordance with applicable local and national codes, including NECA/AA 10402012, Standard for Installing Aluminum Building Wire and Cable (ANSI). Wiring within the unit is sized in accordance with the NEC®. Refer to the unit nameplate and the unit selection report for the correct electrical ratings.

⚠ DANGER

Qualified and licensed electricians must perform wiring. Disconnect, lockout, and tag all electrical power sources to the unit before servicing the compressor and/or removing refrigerant. An electrical shock hazard exists that can cause severe injury or death.

The field power wiring required varies depending on unit model. See for wiring information. These wiring diagrams are also provided with the chiller.

NOTE: Wiring, fuse, and wire size must be in accordance with the NEC®. The voltage to these units must be within ±10% of nameplate voltage (415V units must have voltage within -13% and +6% of nameplate voltage) and the voltage unbalance between phases must not exceed 2%. Since a 2% voltage unbalance will cause a current unbalance of 6 to 10 times the voltage unbalance per the NEMA MG-1 Standard, it is most important that the unbalance between phases be kept at a minimum.

⚠ CAUTION

Do not use power factor correction capacitors with AWW chillers. Doing so can cause harmful electrical resonance in the system. Correction capacitors are not necessary since VFDs inherently maintain high power factors.

Table 3: SCCR Ratings (kAmps)

Voltage/Hz	Standard Short Circuit Panel Rating	High Short Circuit Panel Rating
380/60	10kA	65kA
460/60	10kA	65kA
575/60	5kA	25kA
400/50	10kA	65kA

Field-supplied disconnect switches are required if not factory-supplied with the unit. Disconnecting means are addressed by Article 440 of the NEC®, which requires “disconnecting means capable of disconnecting air conditioning and refrigerating equipment including motor-compressors, and controllers from the circuit feeder.” Select and locate the disconnect switch per the NEC® guidelines.

Terminals are provided in a unit control panel for optional field hookup of the control circuit to a separate fused 115-volt power supply in lieu of the standard factory installed control transformer.

Use with On-Site Generators

Switching from site grid power to generator power and vice versa requires that the chiller must either be powered down or the power must be off for more than five seconds to avoid sending out of phase voltage to the chiller. A properly installed, fully synchronized Automatic Transfer Switch must be used to transfer power if the chiller is running under load.

Generator Sizing

⚠ DANGER

Generator must be sized by an electrical engineer familiar with generator applications.

Transfer Back to Grid Power

Proper transfer from stand-by generator power back to grid power is essential to avoid chiller damage and must be used to ensure proper function of the unit.



WARNING

Stop the chiller before transferring supply power from the generator back to the utility power grid. Transferring power while the chiller is running can cause severe chiller damage.

The necessary procedure for reconnecting power from the generator back to the utility grid is as follows:

1. Set the generator to always run five minutes longer than the unit start-to-start timer, which can be set from two to sixty minutes, while keeping the chiller powered by the generator until the fully synchronized Automatic Transfer Switch properly hands over chiller power from the site.
2. Configure the transfer switch provided with the generator to automatically shut down the chiller before transfer is made. The automatic shut-off function can be accomplished through a BAS interface or with the "remote on/off" wiring connection shown in the field wiring diagrams.

A start signal can be given anytime after the stop signal since the start-to-start timer will be in effect. The default timer setting is 5 minutes but adjustable as low as 3 minutes.

Figure 48: Field Wiring Diagram - Single Point Power

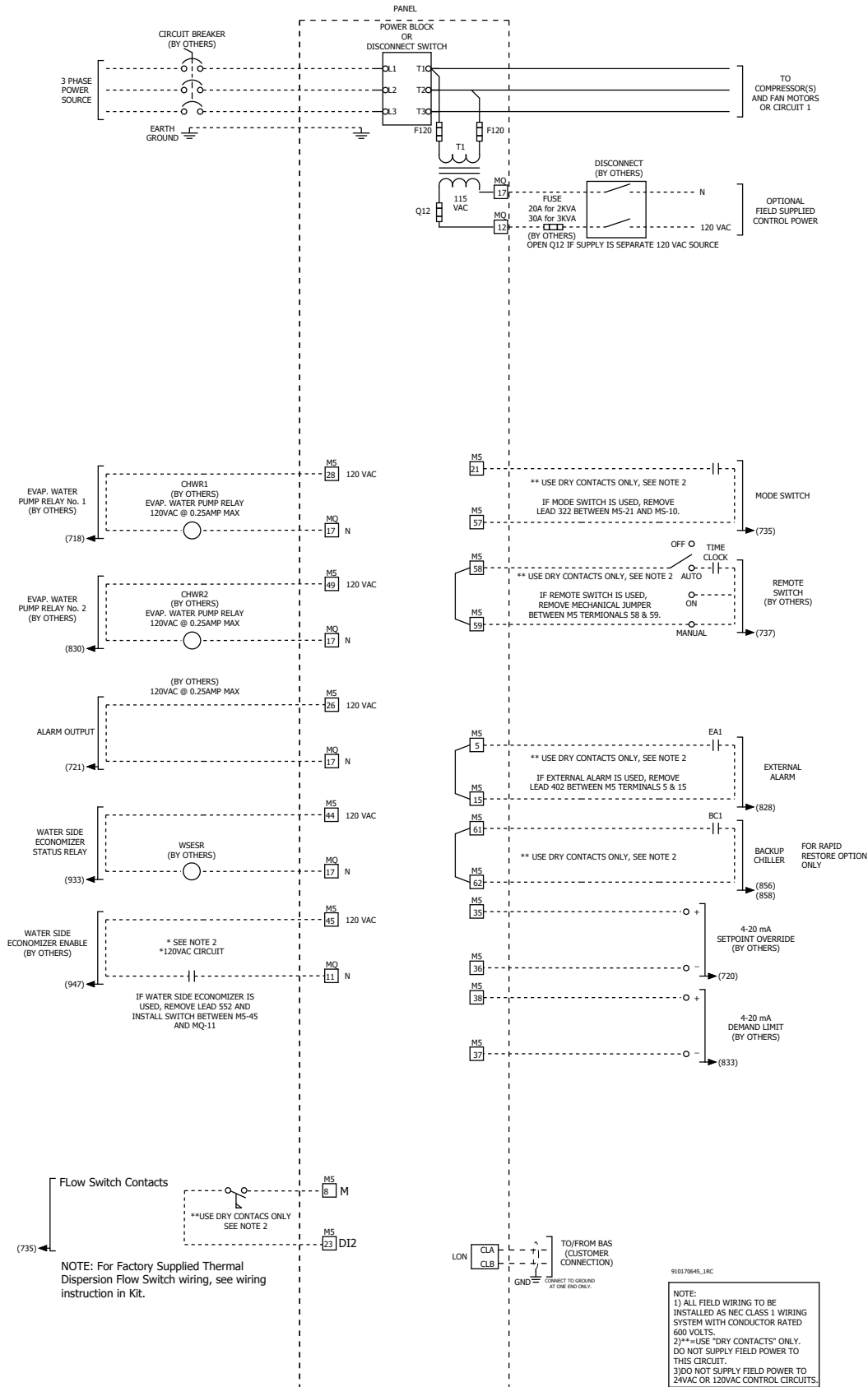

Figure 49: Field Wiring Diagram - Multiple Point Power

Note: Separate grounding is required if fed from different transformers. Otherwise a single ground is acceptable.

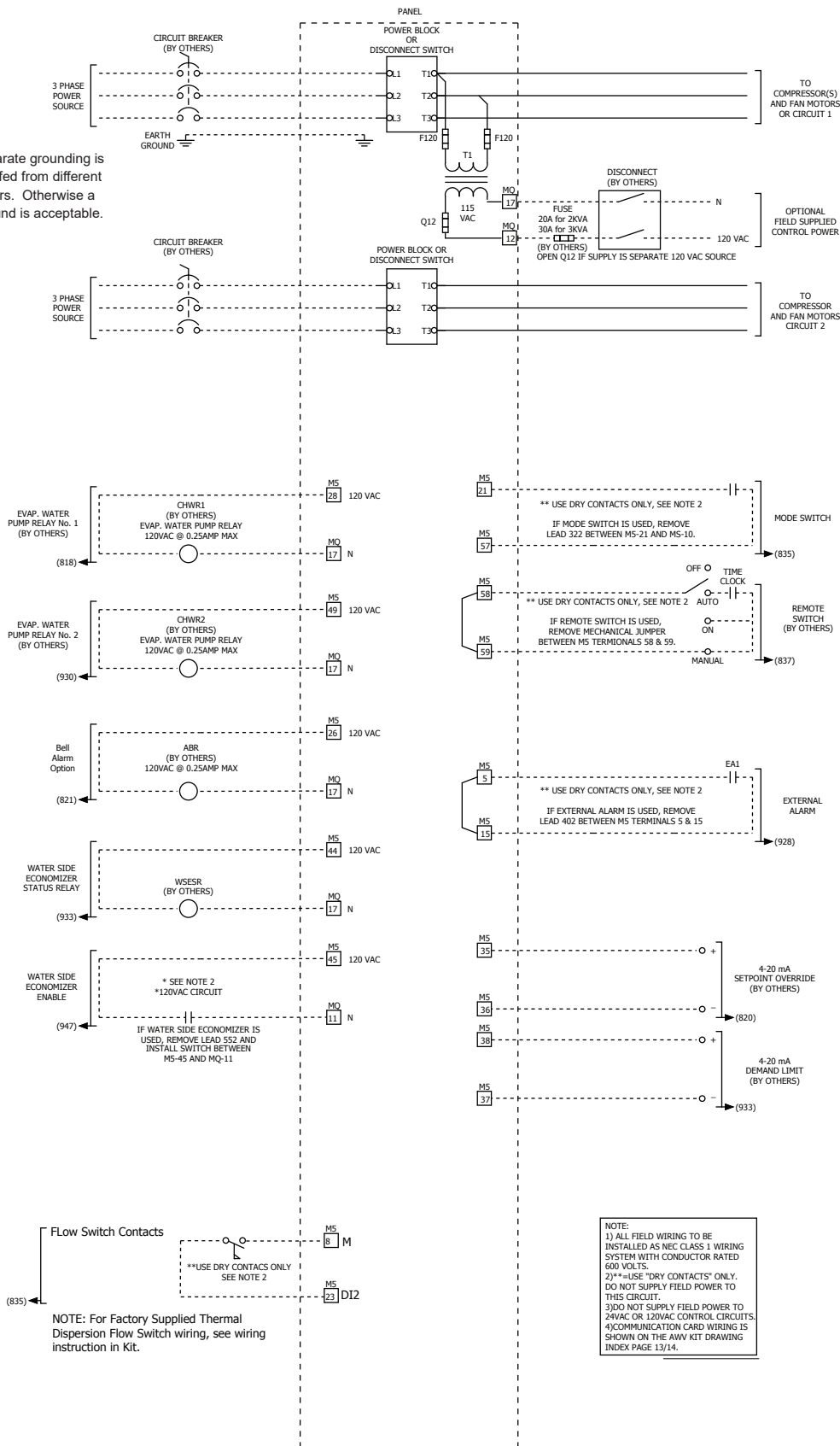

Figure 50: Representative Refrigerant Diagram - Packaged Unit With Shell & Tube Evaporator Without Optional Economizer

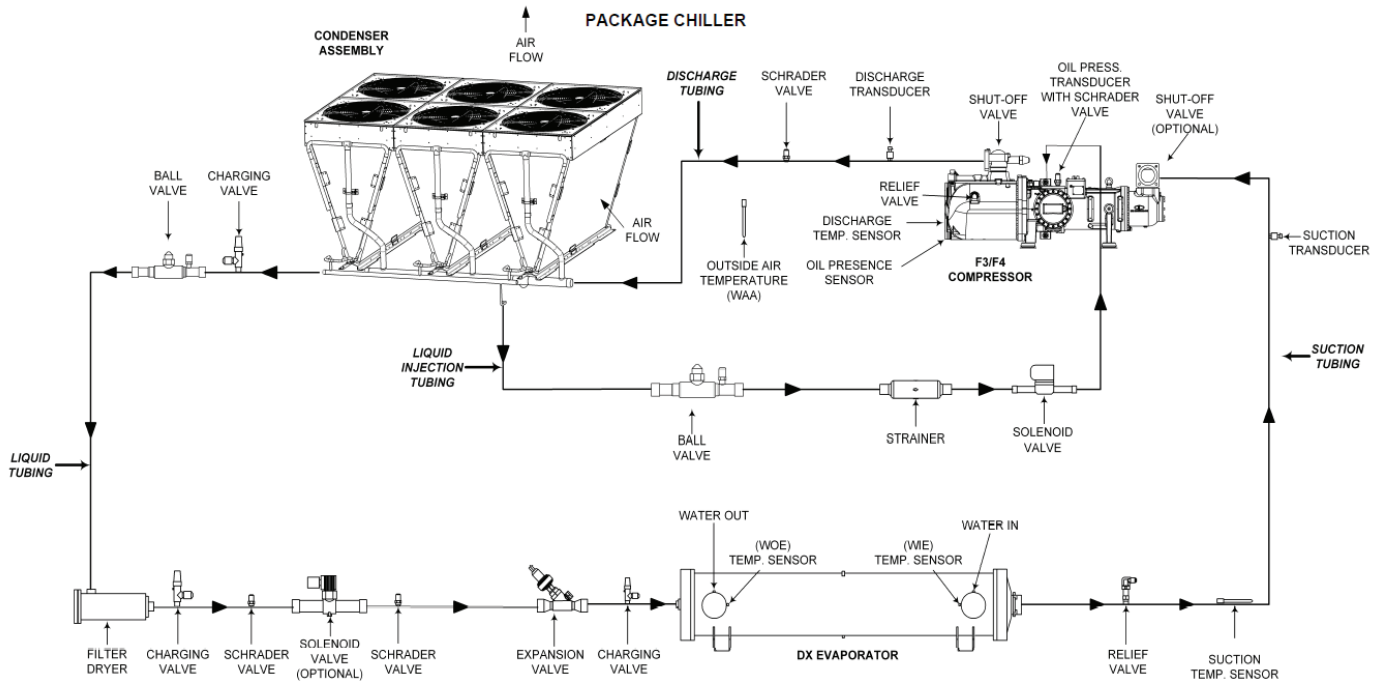
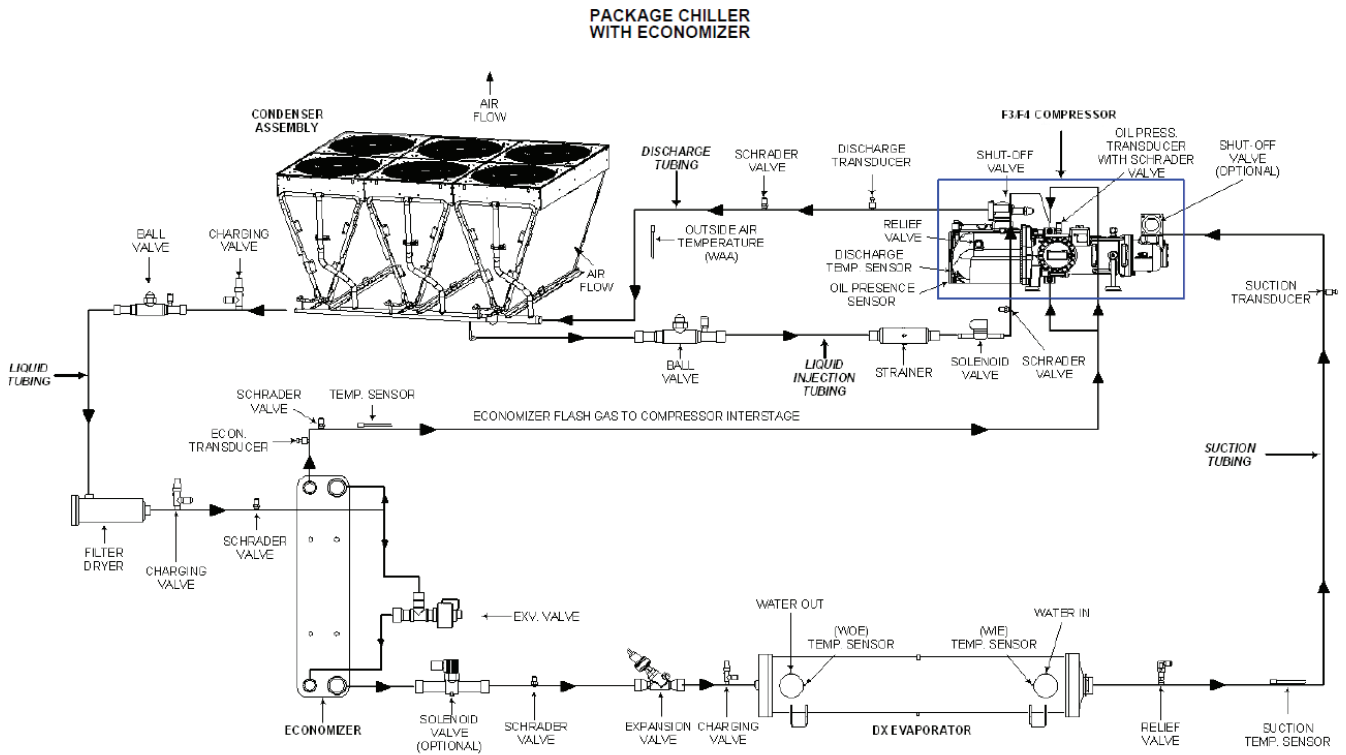

Figure 51: Representative Refrigerant Diagram - Packaged Unit With Shell & Tube Evaporator With Optional Economizer



NOTE: See Figure 52 and Figure 53 for compressor details.

Figure 52: Compressor Hose Configuration with Liquid Injection (Chiller with Economizer)

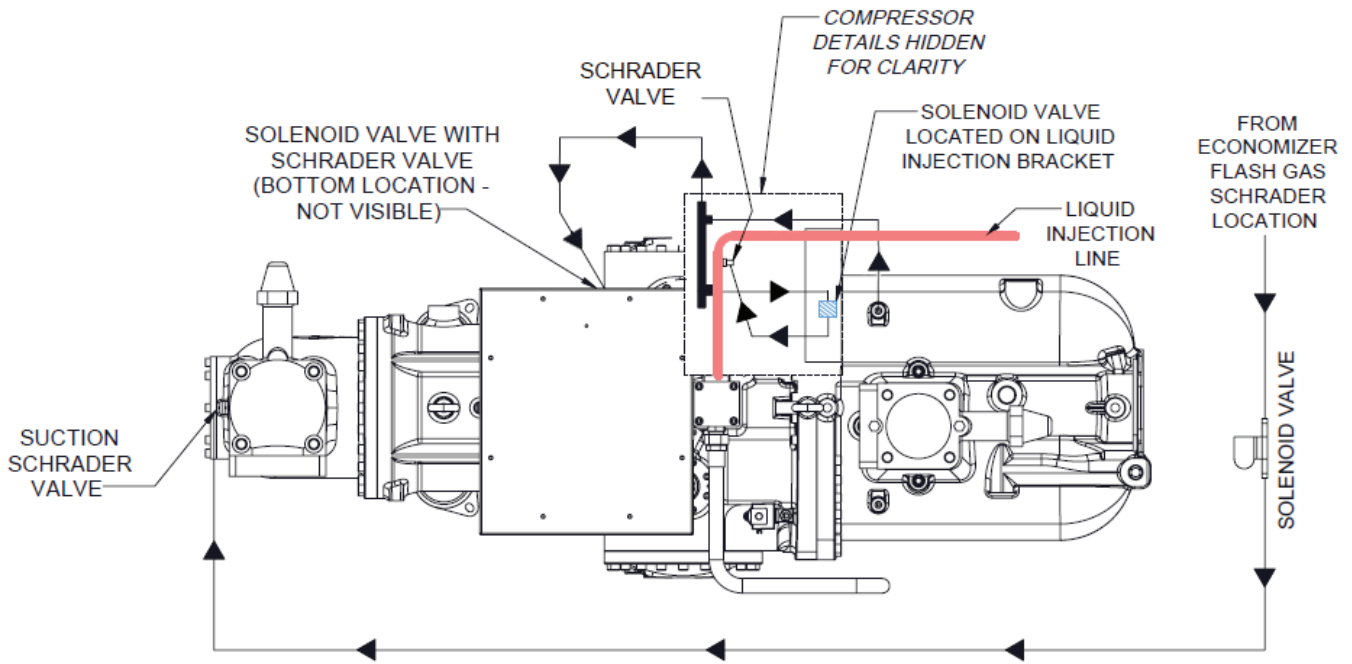

Figure 53: Compressor Hose Configuration without Liquid Injection (Chiller with Economizer)

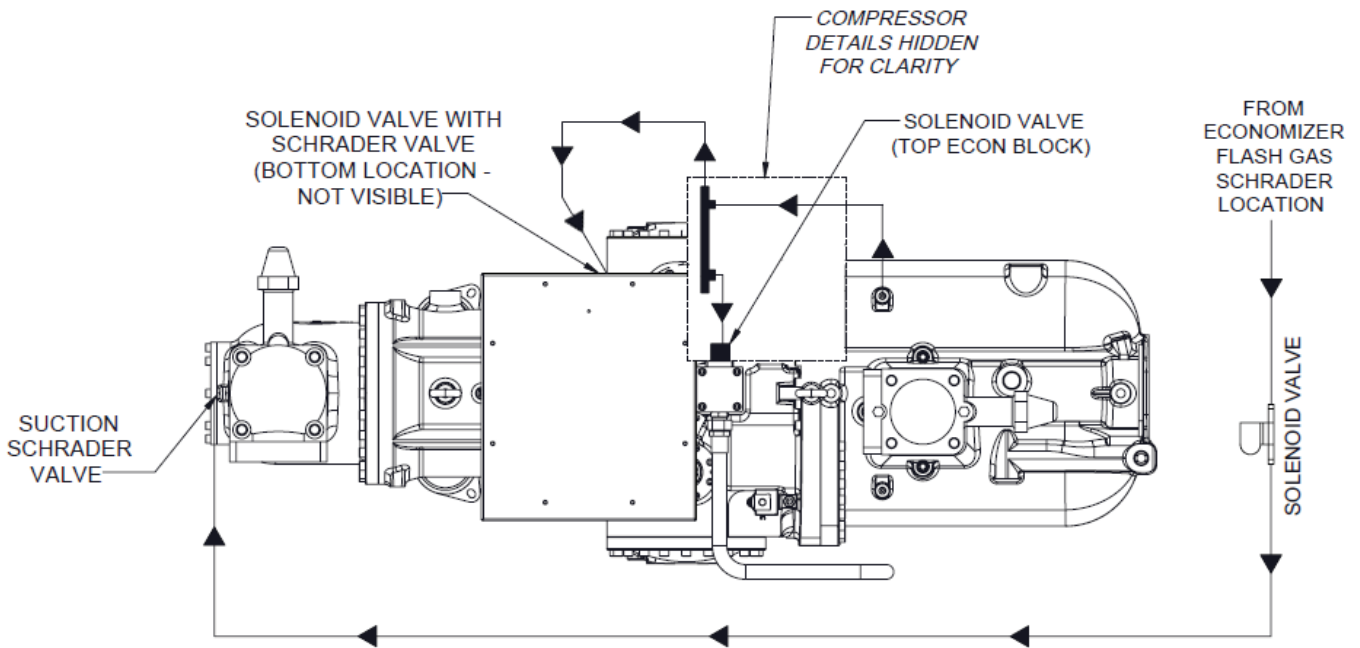

Figure 54: Representative Refrigerant Diagram - Packaged Unit With Braze Plate Evaporator Without Optional Economizer

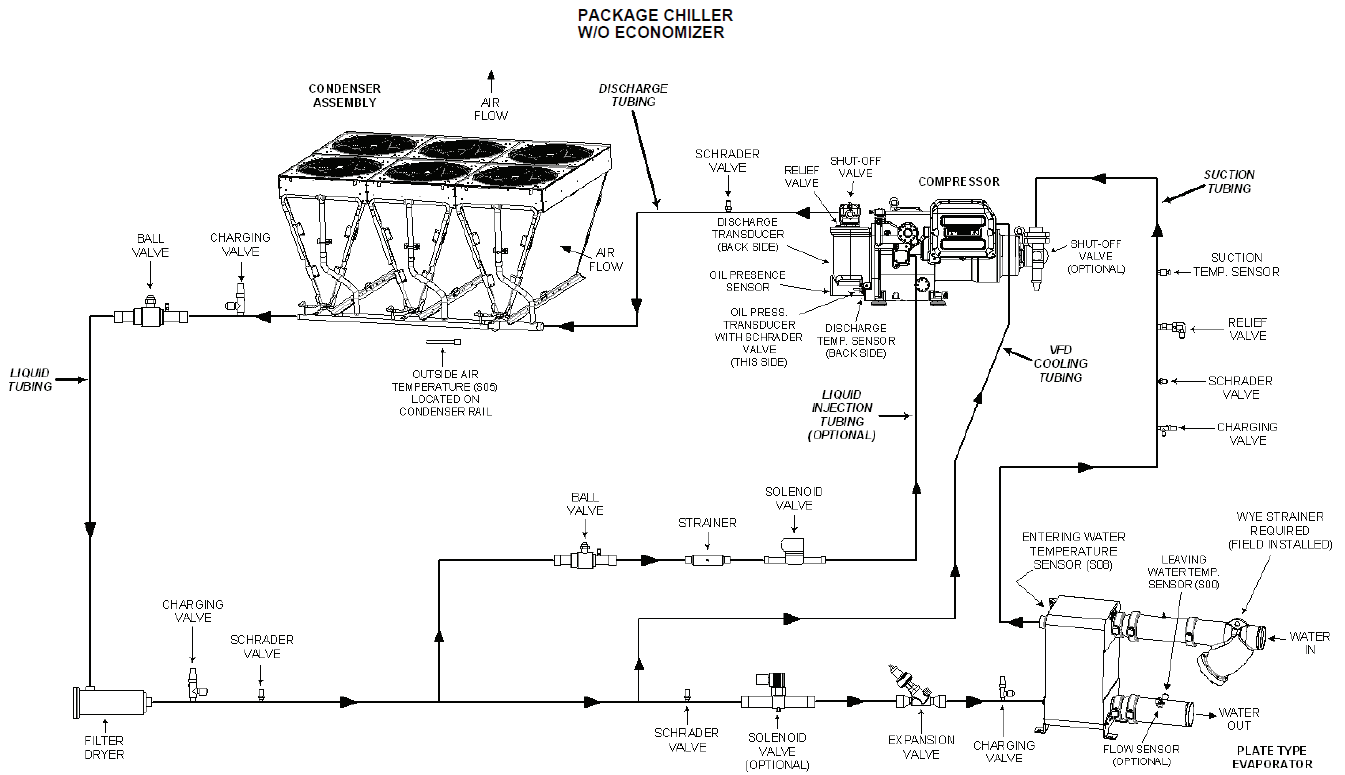
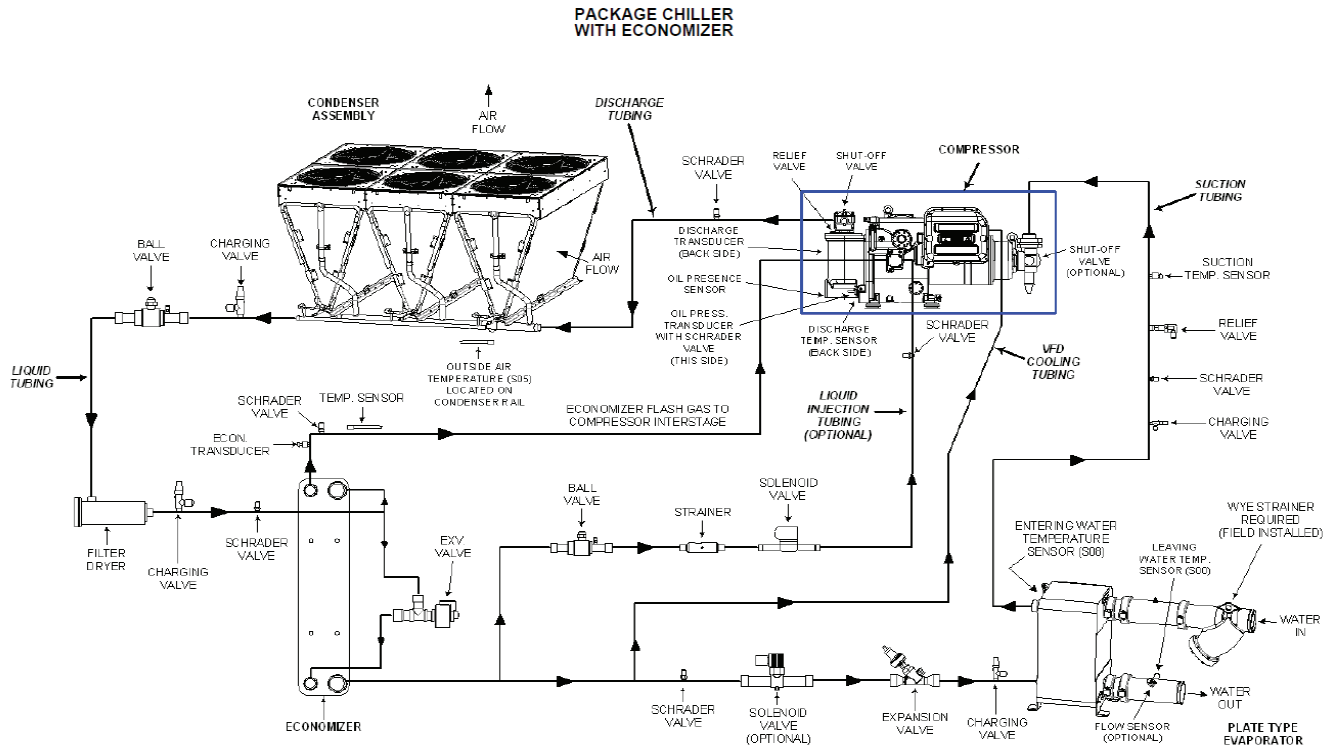

Figure 55: Representative Refrigerant Diagram - Packaged Unit With Braze Plate Evaporator With Optional Economizer



NOTE: See [Figure 56](#) for compressor details

Figure 56: Turboscrew Hose Configuration with or without Liquid Injection (Chiller with Economizer)

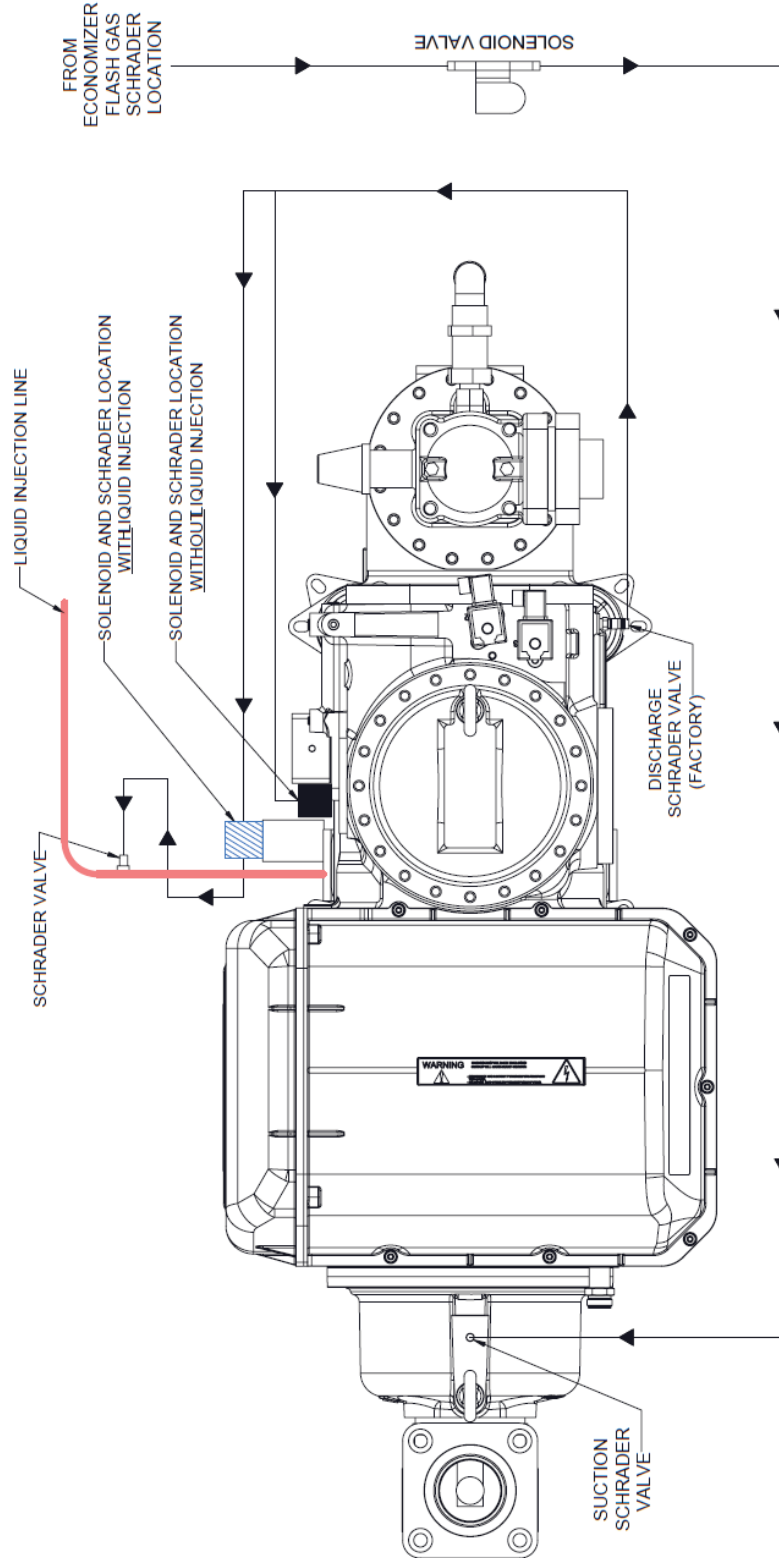
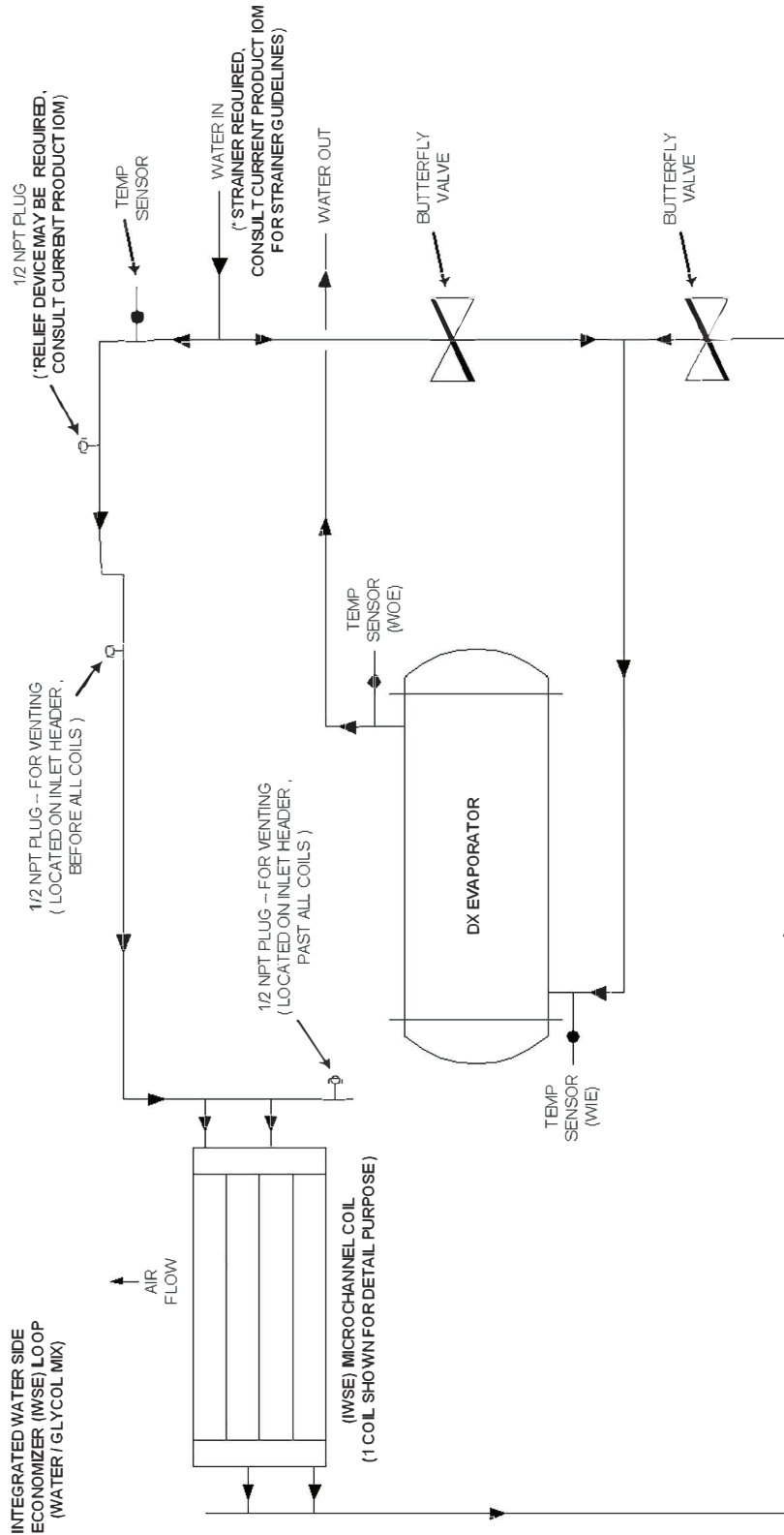

Figure 57: Representative Refrigerant Diagram - Packaged Unit With Optional Integrated Waterside Economizer



Remote Evaporators

Application Considerations

Shipment Method

AWV chillers with remote evaporators ship in three pieces.

- Outdoor condensing unit
- Remote evaporator
- Refrigerant specialties kit with the unit has the following components for field installation:
 - Filter-drier housing and cores for field piping
 - Sight glass
 - Electronic expansion valve
 - Solenoid valve
 - Evaporator vent and drain shutoff valves - waterside
 - Charging valve (on non-economizer models)
 - Suction coupling and flange to attachment evaporator
 - Schrader valve
 - Liquid/saturated coupling and flange to evaporator

Table 4: Data for AWV Remote Evaporator Models Performance Data

Evaporator Model	Water Volume	
	(gal)	(L)
EV40271010/9	67	255
EV40271111/7	66	250
EV40271212/7	63	240
EV50271414/7	106	403
EV50271717/5	99	374
EV50391212/11	154	582
EV66331515/7	225	851
EV66391414/11	271	1027
EV66391616/9	263	995
EV66391717/7	259	979

AWV performance data is available from the current version of Daikin Sales Tools or the local sales office. There is a derate to the performance of an AWV with remote evaporator due to field installed refrigerant line losses, exceeding those found on the packaged arrangement. Use the recommended pipe sizes from [Table 6](#) through [Table 8](#) for design purposes.

Derate Procedure

1. Sketch the liquid and suction piping, including the actual pipe lengths and all fittings.
2. From [Table 5](#), add up the equivalent pressure drop for the fittings in the suction line. Add this value to the actual linear feet of tubing to determine the total equivalent length (TEL) for the piping run.

3. Using Daikin Sales Tools, enter TEL values to determine adjusted unit performance. Consult the Daikin Applied Technical Response Center for all remote evaporator piping installations for review and approval.

Remote Evaporator Refrigerant Piping

Careful design of refrigerant piping is necessary for proper system operation. Refer to the latest version of the ASHRAE Handbook and the Daikin Applied Refrigerant Piping Design Guide, AG31-011, for recommended refrigerant piping practices. Size piping per [Table 6](#). Design the refrigerant piping to accomplish the following:

1. Assure proper refrigerant feed to the evaporator.
2. Provide practical and economical refrigerant line sizes without excess pressure drop.
3. Maintain uniform oil return to the compressor under all load conditions.
4. Keep the refrigerant suction line pressure drop to a maximum of 2°F in saturated temperature equivalent.
5. The velocity of each suction line must be sufficient to return oil at 25% of the circuit rating for the application.
6. When facing the unit control box, the left-hand compressor is circuit #1, and the right-hand is circuit #2.

NOTICE
Service Form SF99006 (current version available from the local sales office) must be submitted to Daikin Applied Technical Response Center and reviewed at least two weeks prior to beginning piping installation

The following applies to all size units:

- New refrigerant piping must be used for all equipment installations. Refrigerant piping must be properly sized for the circuit capacity and unit refrigerant.
- Piping system must be brazed if copper or welded if steel and have the proper lay out with all required components.

Copper (Type L) piping is recommended; carbon steel piping is allowed (see [Table 7](#)). Piping must be installed per industry standards and local codes. Any welded pipe requires a replaceable suction line filter at chiller connect point.

- Measured actual pipe length cannot exceed 200 feet.
- Maximum total equivalent length (TEL) cannot exceed 300 feet (75 feet for vertical suction lines). The evaporator cannot be located more than 20 feet above or 30 feet below the outdoor unit.
- Suction line connection at unit = 4 1/8-inch OD each.
- Underground refrigerant piping is not permitted.
- Field piping must include adequate service taps for checking filter-drier, subcooling, and superheat.
- Insulate complete suction lines. Liquid lines may be insulated to prevent collection of condensation or loss of subcooling if required.
- Ensure the braze rod used is appropriate for the materials being joined.

Table 5: Fitting Losses Equivalent Feet of Pipe

Line Size In. OD	Angle Valve	Globe Valve	90-Degree Std. Radius Elbow	90-Degree Long Radius Elbow
2 5/8	29.0	69.0	6.0	4.1
3 1/8	35.0	84.0	7.5	5.0
3 5/8	41.0	100.0	9.0	5.9
4 1/8	47.0	120.0	10.0	6.7
5 1/8	58.0	140.0	13.0	8.2
6 1/8	70.0	170.0	16.0	10.0
6 Steel	70.0	170.0	16.0	10.0

SOURCE: ASHRAE 2014 Handbook Refrigeration

NOTE: TEL values for the filter-drier and solenoid valve are already included and should not be added to the liquid line drop.

Remote Evaporator Field Wiring Notes:

Installations requiring longer lengths of wire than provided with the chiller will need to field supply the materials and make a splice connection. For all field wiring connections, use watertight boxes at splice locations that may be exposed to weather. Individual connections must be soldered and shrink wrapped. An outer shrink wrap is also required and should be wrapped with electrical tape to make it more water resistant. Wire should be routed in conduit per national and local codes. If code allows wiring to be run outside of conduit, the wiring needs to be suitable for outdoor use in direct sunlight. If running wiring through plenums, it will also need to be plenum rated. Additional considerations should be made to:

- keep power and signal wiring separate to avoid induced voltages or exposure to EMI sources. Never run power cables and signal wires in same conduit.
- avoid any sharp edges or other sources of potential physical damage.
- route and secure cables away from hot surfaces, high voltage lines, and moving components.
- do not reduce the wire lengths of factory wiring, except as specifically noted in item #5.

Specific Wiring Guidance per Component

1. The 120-V liquid line solenoid valves (LSV) come with a din connector and have to be wired directly back to the outdoor unit. Minimum wire gauge to be 14 AWG. Field to wire:
 - **Compressor #1:** (LSV-1) wire 741-1A (red) wires into the unit control box terminal block at MQ74. Wire 741-1B (white) wires to MQ17.
 - **Compressor #2:** (LSV-2) wire 741-2A (red) wires into the unit control box terminal block at MQ84. Wire 741-2B (white) wires to MQ17.
- 2.

3. Two evaporator water temperature sensors with 100 feet of cable coiled up and attached to the unit base for extension to the evaporator and insertion in fittings located on the side of the inlet and outlet nozzles. If additional length of cable is required, the cable needs to be a 2 conductor, twisted pair, shielded cable, with drain wire. This wire within this cable needs to be a minimum of 22 AWG gauge wire for both conductors. Preferably the conductors are colored white and black but not necessary provided notation is made on schematic to aid field servicing of equipment. When sourcing cable, consideration should be made towards Alpha Wire H1 p/n 5481C or equivalent as suitable.
4. One suction line refrigerant temperature sensor per circuit with 100 feet of cable coiled up and attached to the unit base for extension to the evaporator. If additional length of cable is required, the cable needs to be a 2 conductor, twisted pair, shielded cable, with drain wire. This wire within this cable needs to be a minimum of 22 AWG gauge wire for both conductors and drain wire. Preferably the conductors are colored white and black but not necessary provided notation is made on schematic to aid field servicing of equipment. When sourcing cable, consideration should be made towards Alpha Wire H1 p/n 5481C or equivalent as suitable.
5. One suction line pressure transducer per circuit with 100 feet of cable coiled up and attached to the unit base for extension to the evaporator. If additional length of cable is required, the cable needs a 3 conductor, twisted triad, shielded cable, with drain wire. This cable needs a minimum of 22 AWG gauge wire for both conductors. Preferably the conductors are colored red, white, and black but not necessary provided notation is made on schematic to aid field servicing of equipment. When sourcing cable, consideration should be made towards Belden 9363 or equivalent as suitable.

Figure 58: Remote EXV Field Wiring

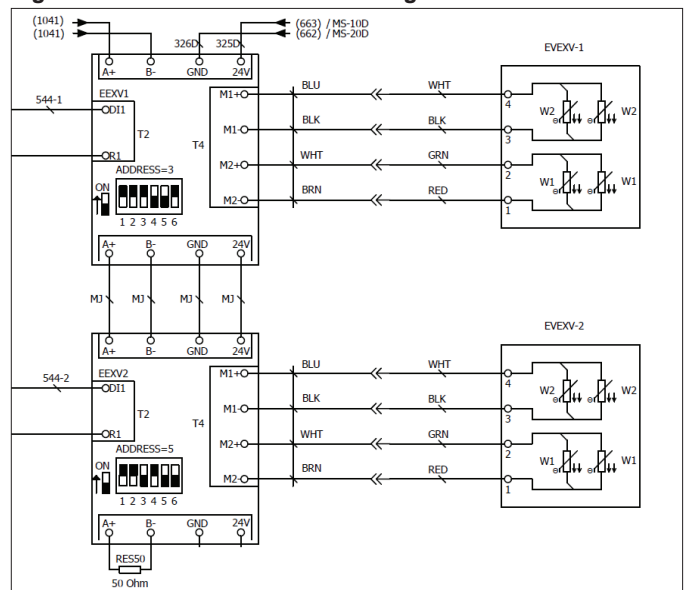

- The electronic expansion valve has a 30 foot long cable attached and can be used when the outdoor unit is less than 30 feet away. For lengths greater than 30 feet but no more than 200 feet, cut the factory supplied 22 AWG cable/wire as close to the M12 connector (connects to the EXV Stepper Motor) as possible to make a splice. The extension cable needs a 4 conductor, shielded cable, with drain wire and a minimum of 14 AWG to total distances up to 200 ft. Preferably the conductors are colored white, black, green, and red but not necessary provided notation is made on schematic to aid field servicing of equipment. When sourcing extension cable, consideration should be given towards Belden 83754 for 14 AWG or equivalent as suitable. The inner foil shield and the outer braid shield should be grounded as close

as possible to the EXV module in the control cabinet. The expansion valve wiring cannot run in conduit with other wiring that is over 24 Volts AC.

- A flow switch must be installed in the leaving chilled water line per manufacturer's instructions and wired to terminals 8 and 23 on terminal block M5 in the chiller control panel. If additional length of cable is required, splice a 4 conductor, shielded cable, with drain wire. This cable needs to be a minimum of 22 AWG. Preferably the conductors are colored white, black, blue, and brown but not necessary provided notation is made on schematic for field servicing of equipment. When sourcing cable, consideration should be made towards Belden 8729, 8723, 9940, or equivalent as suitable.

Figure 59: Piping Schematic, Remote Evaporator (One of Two Circuits)

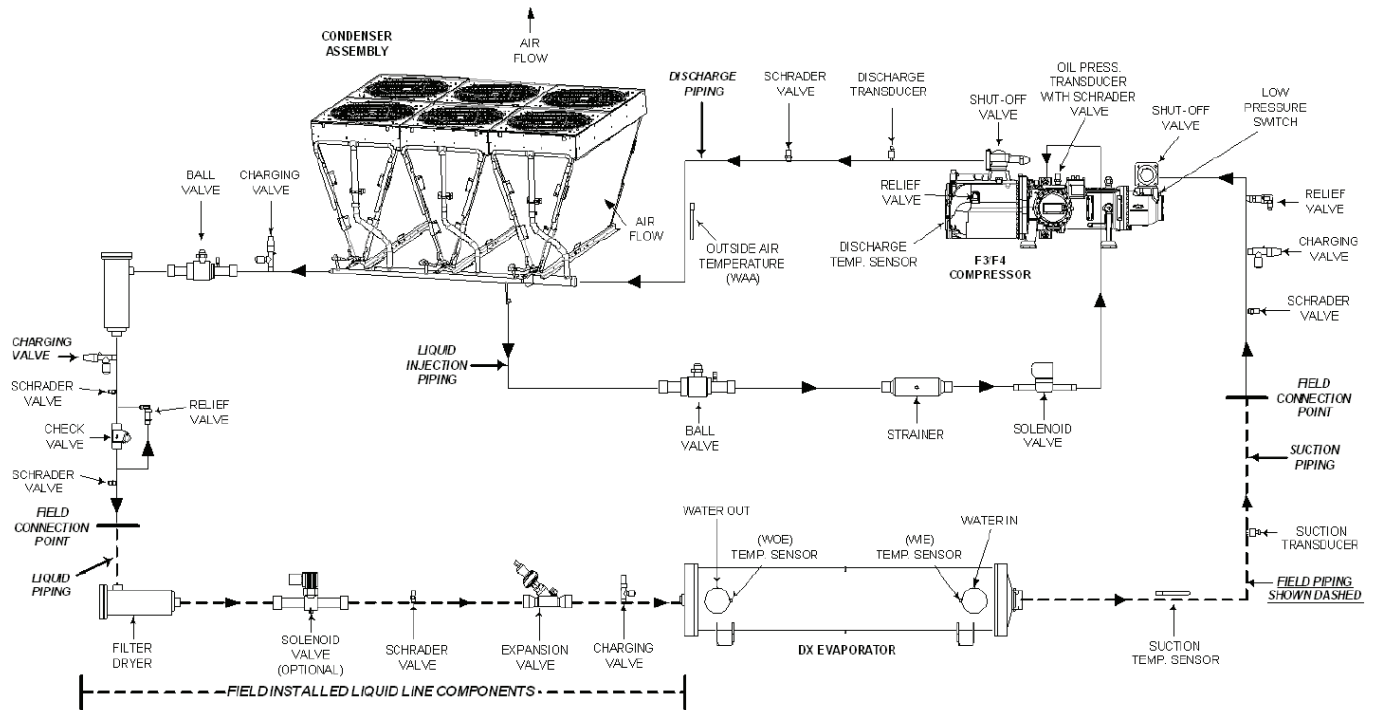

Figure 60: Piping Schematic, Remote Evaporator with Economizer

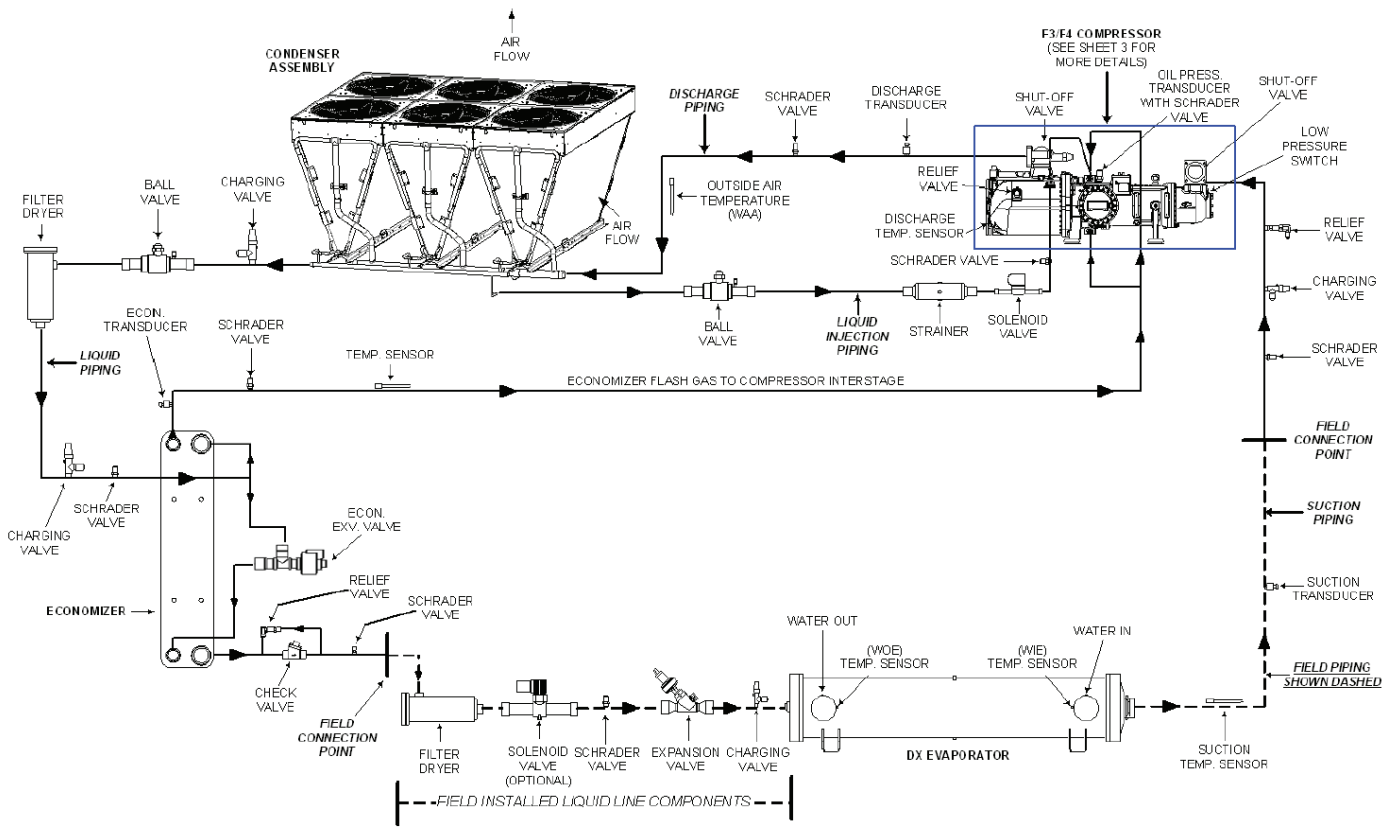

Figure 61: Compressor Hose Configuration with Liquid Injection (Chiller with Economizer)

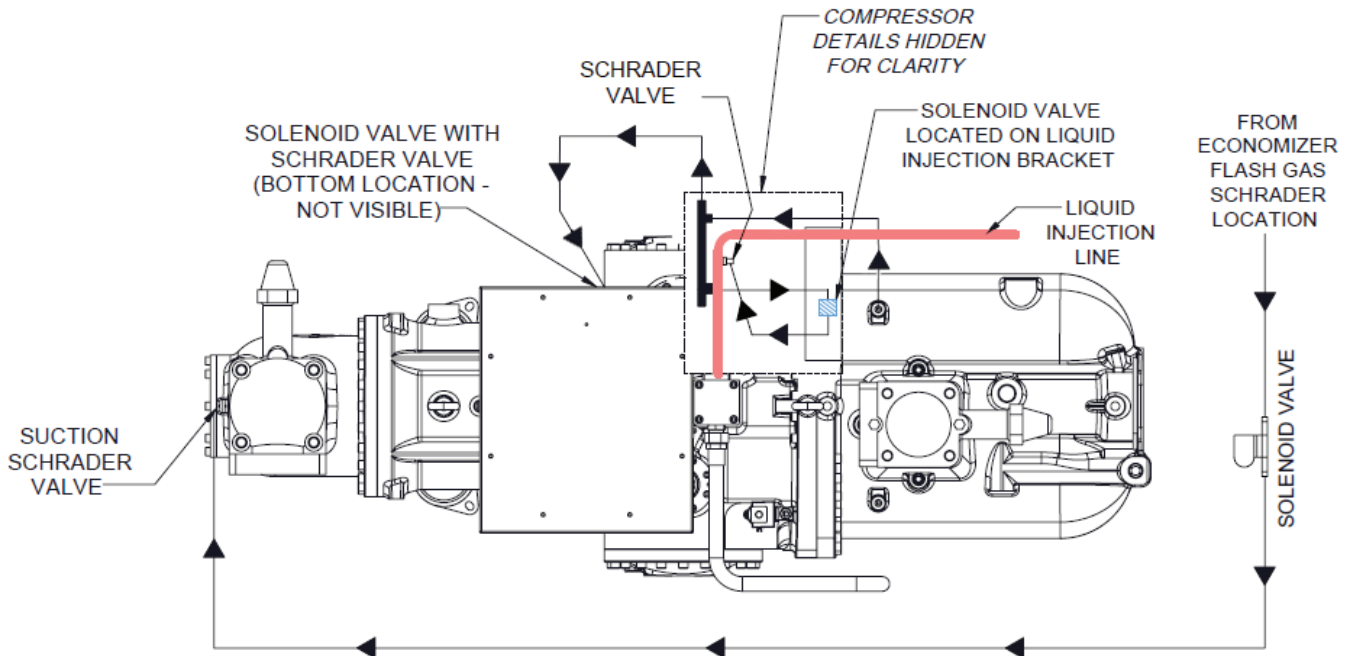
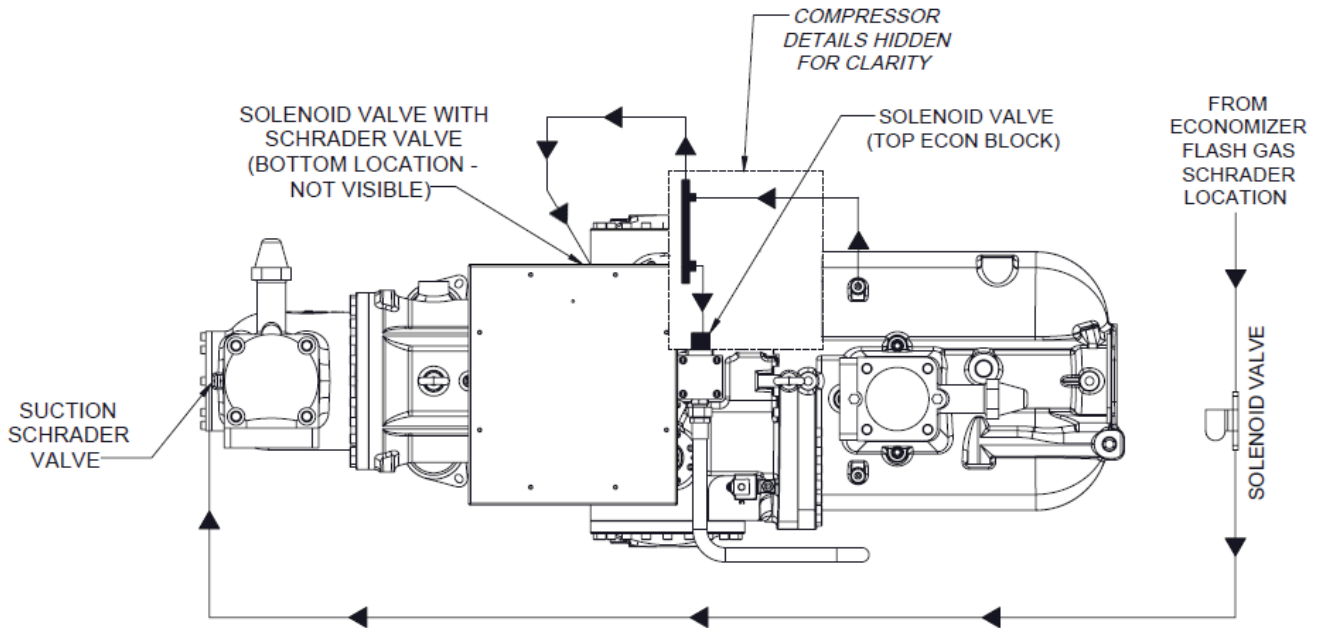

Figure 62: Compressor Hose Configuration without Liquid Injection (Chiller with Economizer)



Piping Layout

Figure 59 shows the piping layout for one of the two refrigerant circuits for AWW units with a remote evaporator with and without the optional economizer circuit. The outdoor unit, the evaporator, and a kit of refrigerant components are shipped as separate pieces for field mounting, wiring, and piping. The suction shutoff valve is standard on remote evaporator units. All components between the “Field Connection Points” should be located as close to the evaporator as possible.

NOTE: Field insulation of the suction lines and the liquid line on circuits with economizers is required. The outdoor unit will have a refrigerant charge equal to that of a packaged unit pumped down into the condenser. Any additional charge of refrigerant and oil required by the field piping is supplied by the customer. The location and size of the refrigerant connections are shown on dimensional drawings available from a Daikin Applied sales representative.

Table 6: Sizing Guidelines for Horizontal or Downflow Suction Lines and Liquid Lines - Copper

Normal Circuit Capacity	Estimated Line TEL (ft)	Recommended Horizontal or Downflow Suction Line Size (inches)		Recommended Liquid Line Size (inches)	
		R-134A	R-513A	R-134A	R-513A
65	50	3 5/8	3 5/8	1 5/8	1 5/8
90	50	3 5/8	3 5/8	1 5/8	1 5/8
115	50	3 5/8	3 5/8	1 5/8	1 5/8
140	50	4 1/8	4 1/8	1 5/8	2 1/8
165	50	4 1/8	4 1/8	2 1/8	2 1/8
190	50	4 1/8	4 1/8	2 1/8	2 1/8
215	50	5 1/8	5 1/8	2 1/8	2 1/8
240	50	5 1/8	5 1/8	2 1/8	2 1/8
265	50	5 1/8	5 1/8	2 1/8	2 1/8
65	75	3 5/8	3 5/8	1 5/8	1 5/8
90	75	3 5/8	3 5/8	1 5/8	1 5/8
115	75	4 1/8	4 1/8	2 1/8	2 1/8
140	75	4 1/8	4 1/8	2 1/8	2 1/8
165	75	5 1/8	5 1/8	2 1/8	2 1/8
190	75	5 1/8	5 1/8	2 1/8	2 1/8
215	75	5 1/8	5 1/8	2 1/8	2 1/8
240	75	5 1/8	5 1/8	2 1/8	2 5/8
265	75	5 1/8	5 1/8	2 5/8	2 5/8
65	100	3 5/8	3 5/8	1 5/8	1 5/8

Recommended Horizontal or Downflow Suction Line Size (inches)				Recommended Liquid Line Size (inches)	
Normal Circuit Capacity	Estimated Line TEL (ft)	R-134A	R-513A	R-134A	R-513A
90	100	3 5/8	3 5/8	1 5/8	1 5/8
115	100	4 1/8	4 1/8	2 1/8	2 1/8
140	100	5 1/8	5 1/8	2 1/8	2 1/8
165	100	5 1/8	5 1/8	2 1/8	2 1/8
190	100	5 1/8	5 1/8	2 1/8	2 5/8
215	100	5 1/8	5 1/8	2 5/8	2 5/8
240	100	6 1/8	6 1/8	2 5/8	2 5/8
265	100	6 1/8	6 1/8	2 5/8	2 5/8
65	125	3 5/8	3 5/8	1 5/8	1 5/8
90	125	4 1/8	4 1/8	1 5/8	2 1/8
115	125	4 1/8	4 1/8	2 1/8	2 1/8
140	125	5 1/8	5 1/8	2 1/8	2 1/8
165	125	5 1/8	5 1/8	2 1/8	2 1/8
190	125	5 1/8	5 1/8	2 5/8	2 5/8
215	125	6 1/8	6 1/8	2 5/8	2 5/8
240	125	6 1/8	6 1/8	2 5/8	2 5/8
265	125	6 1/8	6 1/8	2 5/8	2 5/8
65	150	3 5/8	3 5/8	1 5/8	1 5/8
90	150	4 1/8	4 1/8	2 1/8	2 1/8
115	150	4 1/8	4 1/8	2 1/8	2 1/8
140	150	5 1/8	5 1/8	2 1/8	2 1/8
165	150	5 1/8	5 1/8	2 1/8	2 5/8
190	150	6 1/8	6 1/8	2 5/8	2 5/8
215	150	6 1/8	6 1/8	2 5/8	2 5/8
240	150	6 1/8	6 1/8	2 5/8	2 5/8
265	150	6 1/8	6 1/8	2 5/8	2 5/8
65	175	4 1/8	4 1/8	1 5/8	1 5/8
90	175	4 1/8	4 1/8	2 1/8	2 1/8
115	175	4 1/8	4 1/8	2 1/8	2 1/8
140	175	5 1/8	5 1/8	2 1/8	2 1/8
165	175	5 1/8	5 1/8	2 5/8	2 5/8
190	175	6 1/8	6 1/8	2 5/8	2 5/8
215	175	6 1/8	6 1/8	2 5/8	2 5/8
240	175	6 1/8	6 1/8	2 5/8	3 1/8
265	175	6 1/8	6 1/8	2 5/8	3 1/8
65	200	4 1/8	4 1/8	1 5/8	2 1/8
90	200	4 1/8	4 1/8	2 1/8	2 1/8
115	200	4 1/8	4 1/8	2 1/8	2 1/8
140	200	5 1/8	5 1/8	2 1/8	2 1/8
165	200	5 1/8	5 1/8	2 5/8	2 5/8
190	200	6 1/8	6 1/8	2 5/8	2 5/8
215	200	6 1/8	6 1/8	2 5/8	2 5/8

Recommended Horizontal or Downflow Suction Line Size (inches)				Recommended Liquid Line Size (inches)	
Normal Circuit Capacity	Estimated Line TEL (ft)	R-134A	R-513A	R-134A	R-513A
240	200	6 1/8	6 1/8	2 5/8	3 1/8
265	200	6 1/8	6 1/8	3 1/8	3 1/8
65	225	4 1/8	4 1/8	2 1/8	2 1/8
90	225	4 1/8	4 1/8	2 1/8	2 1/8
115	225	4 1/8	4 1/8	2 1/8	2 1/8
140	225	5 1/8	5 1/8	2 5/8	2 5/8
165	225	5 1/8	5 1/8	2 5/8	2 5/8
190	225	6 1/8	6 1/8	2 5/8	2 5/8
215	225	6 1/8	6 1/8	2 5/8	3 1/8
240	225	6 1/8	6 1/8	3 1/8	3 1/8
265	225	6 1/8	6 1/8	3 1/8	3 1/8
65	250	4 1/8	4 1/8	2 1/8	2 1/8
90	250	4 1/8	4 1/8	2 1/8	2 1/8
115	250	4 1/8	4 1/8	2 1/8	2 1/8
140	250	5 1/8	5 1/8	2 5/8	2 5/8
165	250	5 1/8	5 1/8	2 5/8	2 5/8
190	250	6 1/8	6 1/8	2 5/8	2 5/8
215	250	6 1/8	6 1/8	2 5/8	3 1/8
240	250	6 1/8	6 1/8	3 1/8	3 1/8
265	250	6 1/8	6 1/8	3 1/8	3 1/8
65	275	4 1/8	4 1/8	2 1/8	2 1/8
90	275	4 1/8	4 1/8	2 1/8	2 1/8
115	275	4 1/8	4 1/8	2 1/8	2 5/8
140	275	5 1/8	5 1/8	2 5/8	2 5/8
165	275	5 1/8	5 1/8	2 5/8	2 5/8
190	275	6 1/8	6 1/8	2 5/8	2 5/8
215	275	6 1/8	6 1/8	3 1/8	3 1/8
240	275	6 1/8	6 1/8	3 1/8	3 1/8
265	275	6 1/8	6 1/8	3 1/8	3 1/8
65	300	4 1/8	4 1/8	2 1/8	2 1/8
90	300	4 1/8	4 1/8	2 1/8	2 1/8
115	300	4 1/8	4 1/8	2 1/8	2 5/8
140	300	5 1/8	5 1/8	2 5/8	2 5/8
165	300	5 1/8	5 1/8	2 5/8	2 5/8
190	300	6 1/8	6 1/8	2 5/8	3 1/8
215	300	6 1/8	6 1/8	3 1/8	3 1/8
240	300	6 1/8	6 1/8	3 1/8	3 1/8
265	300	6 1/8	6 1/8	3 1/8	3 1/8

Table 7: Horizontal or Downflow Suction Lines - Steel

Recommended Horizontal or Downflow Suction Line Size			
Nominal Circuit Capacity	Estimated Line TEL (ft)	Line Material	Suction Line Size (Inches)
240	100	Steel	6
265	100	Steel	6
215	125	Steel	6
240	125	Steel	6
265	125	Steel	6
190	150	Steel	6
215	150	Steel	6
240	150	Steel	6
265	150	Steel	6
190	175	Steel	6
215	175	Steel	6
240	175	Steel	6
265	175	Steel	6
190	200	Steel	6
215	200	Steel	6
240	200	Steel	6
265	200	Steel	6
190	225	Steel	6
215	225	Steel	6
240	225	Steel	6
265	225	Steel	6
190	250	Steel	6
215	250	Steel	6
240	250	Steel	6
265	250	Steel	6
190	275	Steel	6
215	275	Steel	6
240	275	Steel	6
265	275	Steel	6
190	300	Steel	6
215	300	Steel	6
240	300	Steel	6
265	300	Steel	6

NOTE: FOR STEEL LINES ONLY

For use in horizontal and down flow applications only where the evaporator is at or below the chiller elevation.

Recommend schedule 40 steel pipe.

Carbon steel pipe shall be ASTM Standard A 53 Grade B, Type E (electric resistance welded) or Type S (seamless); or ASTM Standard A 106 Grade B (seamless). Standard A 53 Type F is not permitted.

Refrigeration piping design and fabrication should be in accordance with the applicable sections of ASME B31.5 - Refrigeration Piping and Heat Transfer Components for the steel piping.

Table 8: Sizing Guidelines for Upflow Lines

Recommended Upflow Suction Line Size			
Nominal Circuit Capacity	Line Material	Suction Line Size (Inches)	Estimated Line TEL (ft)
65	Copper	3 5/8	50
90	Copper	3 5/8	50
115	Copper	3 5/8	50
140	Copper	4 1/8	50
165	Copper	4 1/8	50
190	Copper	5 1/8	50
215	Copper	5 1/8	50
240	Copper	5 1/8	50
265	Copper	5 1/8	50
65	Copper	3 5/8	75
90	Copper	3 5/8	75
115	Copper	3 5/8	75
140	Copper	4 1/8	75
165	Copper	4 1/8	75
190	Copper	5 1/8	75
215	Copper	5 1/8	75
240	Copper	5 1/8	75
265	Copper	5 1/8	75

Pump Packages

Factory-installed pump packages provide important benefits:

- Simplify the chilled water system design and installation
- Provide installation savings by reducing field piping, wiring, and control costs
- Save valuable floor space inside the building
- Reduces project engineering content

Standard Components

Single Pump

Single Pump: variable speed horizontal endsuction pump, available in many different casing and impeller size combinations to meet jobsite flow and head requirements.

Dual Pumps

Dual Pump: two variable speed horizontal end-suction pumps (duty/standby), available in many different casing and impeller size combinations to meet jobsite flow and head requirements

Additional factory provided components:

The optional pump package is also equipped with:

- discharge and suction shutoff valves
- check valve (on dual pump configurations)
- water pressure gauges on pump suction and discharge
- factory power and control wiring from the chiller to the pump package control panel
- interconnecting piping and insulation of all cold surfaces

Optional components that may be factory or field supplied:

- Expansion tank with size increments from 15 to 80 gallons, field installed.

Pumps

Pump Design Features

Pump packages may be single or dual pump arrangement. Each pump is a vertical, in-line, radially split-case pump with a single spring inside mechanical seal with carbon against silicon carbide faces. Each case is cast iron. Impellers are bronze, trimmed to design conditions and then balanced. The shaft sleeve is bronze, extending the full length of the seal area.

Dual pumps are mounted in a common casing with a common inlet connection and outlet connection. The pumps are designed for duty/standby, not parallel operation, and is capable of having one side running at one time. A flapper valve on the discharge side of the casing is flipped over to the side by the moving water to prevent recirculation when only one pump is operating. The servicing of one side of the pump will require the following:

- to stop running the pump
- remove the one rotating head

- install a gasket and blanking plate on one side of the pump casing
- start the pump back up with the one rotating head and the defective one can be serviced.

For all pump arrangements, each pump is serviceable without breaking pipe connections. The motor and pump rotating assembly can be serviced without removing the pump casing from the line.

Pump performance curves are generated by Daikin Tools for the specific criteria of the installation. Contact a Daikin Applied representative for this information.

Pumps and pump package components are not heat traced and may require additional freeze protection measures.

Pump Operating Control

Constant Flow

The pumps will run at constant speed and will start and stop automatically with the chiller unit. When the chiller is enabled to run by having its MicroTech unit controller in the Auto state or by a signal from a BAS (not necessarily with compressors running based on availability of a cooling load), the pump panel will receive a signal to start from the chiller controller when either the chilled water leaving or entering temperature reaches the chiller freeze point setting to help prevent freeze up. When there is sufficient flow to close the flow switch within a timed period (recirc timer), a proof-of-flow signal is sent to the chiller and the pump is in the Run state. If there is a call for cooling based on the chilled water temperature, the chiller will commence its compressor startup procedure. If there is no call for cooling, the chiller will be on stand-by waiting for load.

If the flow switch does not see flow, the pump remains in the Start state until flow is established, at which time the pump will be in the Run state. Flow is recognized when the flow switch indicates flow for longer than the recirc timer setpoint.

The Run state is a control condition established by satisfying certain conditions. The Start state means that a digital signal has been sent to the pump for it to start running.

When starting the chiller, it is prudent to be sure there is flow so the chiller compressors will be able to start based on a call for cooling due to high chilled water temperature. Observing water pressure gauges can confirm flow.

Flow interruption will open the flow switch, sending a signal to the chiller to shut down and also de-energize the pump. If the chiller is turned off, the pump will shut off after a timed period to allow water circulation during refrigerant pumpdown.

Variable Flow with Pump VFD

The operating cost savings resulting from using variable chilled water flow via a pump VFD is well known. Daikin Applied offers flow control through the pump VFD without the need for external pressure sensors. In addition to the sensorless operation, there are three other selectable operating modes:

- **BAS Input:** The pump speed and system flow will be

controlled from a customer-supplied BAS input signal

- **Remote Sensor Control:** The VFD is wired to a pressure sensor mounted in the chilled water piping system. This is the standard VFD control when a sensorless VFD is not used.
- **Locally Selected Constant Speed Control:** Provides manual control of the pump speed, overriding any current automatic speed control.

Consult the current version of the installation manual for additional detailed information, which is available from your local Daikin Applied sales office or on www.DaikinApplied.com.

Sensorless Pressure Control

Onboard measurements allow control of the pump speed to optimize chilled water flow with respect to water system pressure. External pressure sensors are not required, eliminating design and installation effort. The unit is factory-configured for this mode.

NOTE: Sensorless operation is only allowed for single chiller systems. Systems with parallel chiller operation must use one of the other control methods.

The default control mode for Sensorless pumps is 'Quadratic Pressure Control' where the controller is set to control the speed according to a 'control curve' between max and min flow (see Figure 63). The control curve is designed to replicate sensor positions at varying distances from the pump based on power, frequency, pressure, and flow across the flow range of the pump. Speed and pressure are adjusted to match the system load without the need for a sensor located at the most remote load point.

The quadratic measurements enable the pump to continuously identify the head and flow at any point in time which gives accurate pressure control without the need for external feedback signals such as a remote sensor. Incorporating the pump's hydraulic data into the controller and removing sensors results in true integration of all components and removes the risk of remote sensor failure.

Figure 63: Pump Control Curve

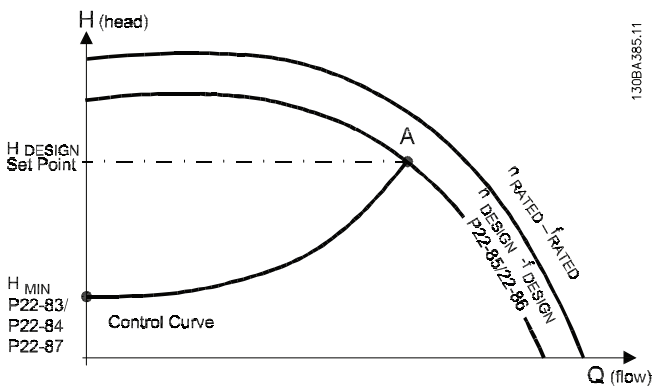

Previously, a differential pressure sensor was placed at the most remote load, across the supply piping and return piping encompassing the valve and coil set, as common practice for system energy efficiency. Sensorless control can replicate this control without the need for that remote sensor. As the flow required by the system is reduced, the pump automatically reduces the head developed according to the pre-set control curve.

In systems with a remote sensor, it is often found that using a differential pressure sensor to sense the pressure across a remote load could theoretically result in loads close to the pump being under-pumped. The situation would be where the load at a loop extremity is satisfied and the control valve closes while a load close to the pump needs full flow. The probability of this occurring is remote but it is possible. One answer to this is to move the sensor closer to the pump (two-thirds of the way out into the system is a popular recommendation) although physically re-positioning the sensor at commissioning stage can be a costly exercise. With Sensorless pump control it is possible to replicate the moving of a sensor by adjusting the head setting 'Hmin'.

BAS Control

The pump speed will be controlled according to the voltage level from a BAS input signal. The pump control protocol is the same as ordered from the chiller unit. BAS inputs may be: BACnet® MS/TP, LONWORKS® or Modbus.

NOTE: BACnet® Ethernet/IP is currently unavailable.

Remote Sensor Control

The VFD is wired to pressure differential switch(s) mounted in the chilled water piping system. This is the standard VFD control when a sensorless VFD is not used.

Locally Selected Constant Speed Control

This mode is selected by pressing the Hand On key. Operation of the pump at a constant speed as selected on the VFD control panel. This mode allows selecting a pump speed to match the system curve.

Dimensional Drawings

Drawings, dimensional values, and other information may change depending on options or configurations selected. Refer to the as-built submittal drawings provided by a Daikin Applied sales representative for configuration-specific details.

Figure 64: Reference Dimensional Drawing - 08 Fan to 14 Fan Configurations With Brazed Plate Evaporator

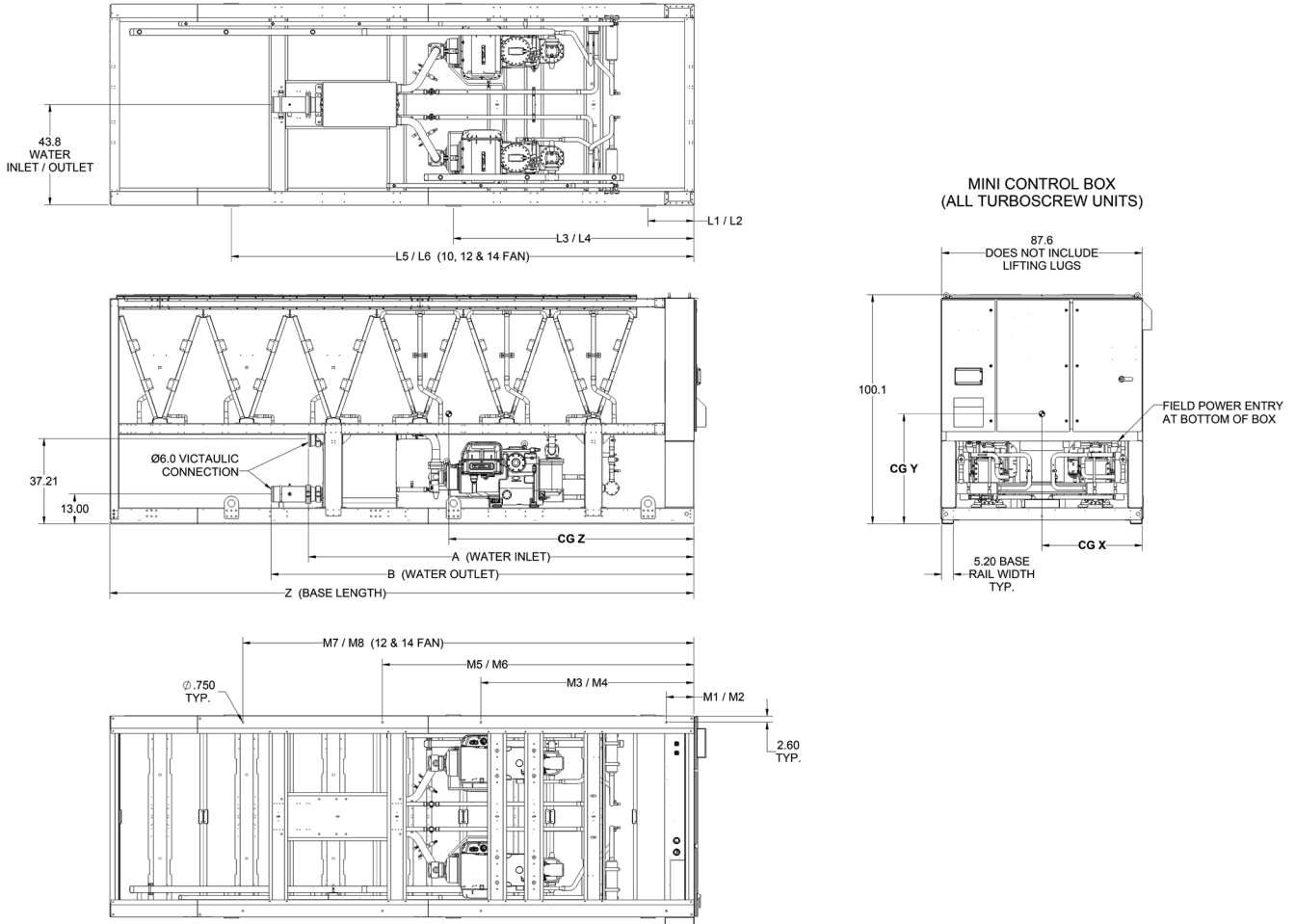

Table 9: Unit Dimensions by Configuration with Brazed Plate Evaporator

# OF FANS	EVAP	A	B	Z	CG X	CG Y	CG Z	L1 / L2	L3 / L4	L5 / L6	M1 / M2	M3 / M4	M5 / M6	M7 / M8	
8	ACH1000DQ-166	152.8	169.1	179.3	Refer to Submitted As-Built Drawings	20	12	93	148	N/A	160	N/A	190	250.0	
	ACH1000DQ-206	156.5	172.8							160					
10	ACH1000DQ-206	156.5	172.8	217.2					105	169	190				
	ACH1000DQ-250	160.7	177												
	ACH1000DQ-330	168.3	184.6												
12	ACH1000DQ-206	156.5	172.8	255.1					105	202	136				197
	ACH1000DQ-250	160.7	177												
	ACH1000DQ-330	168.3	184.6												
14	ACH1000DQ-250	160.7	177.0	293.0					139.0	228.0	136.0				
	ACH1000DQ-330	168.3	184.6												

Figure 65: Reference Dimensional Drawing - 12 Fan and 14 Fan Configurations with Shell and Tube Evaporator

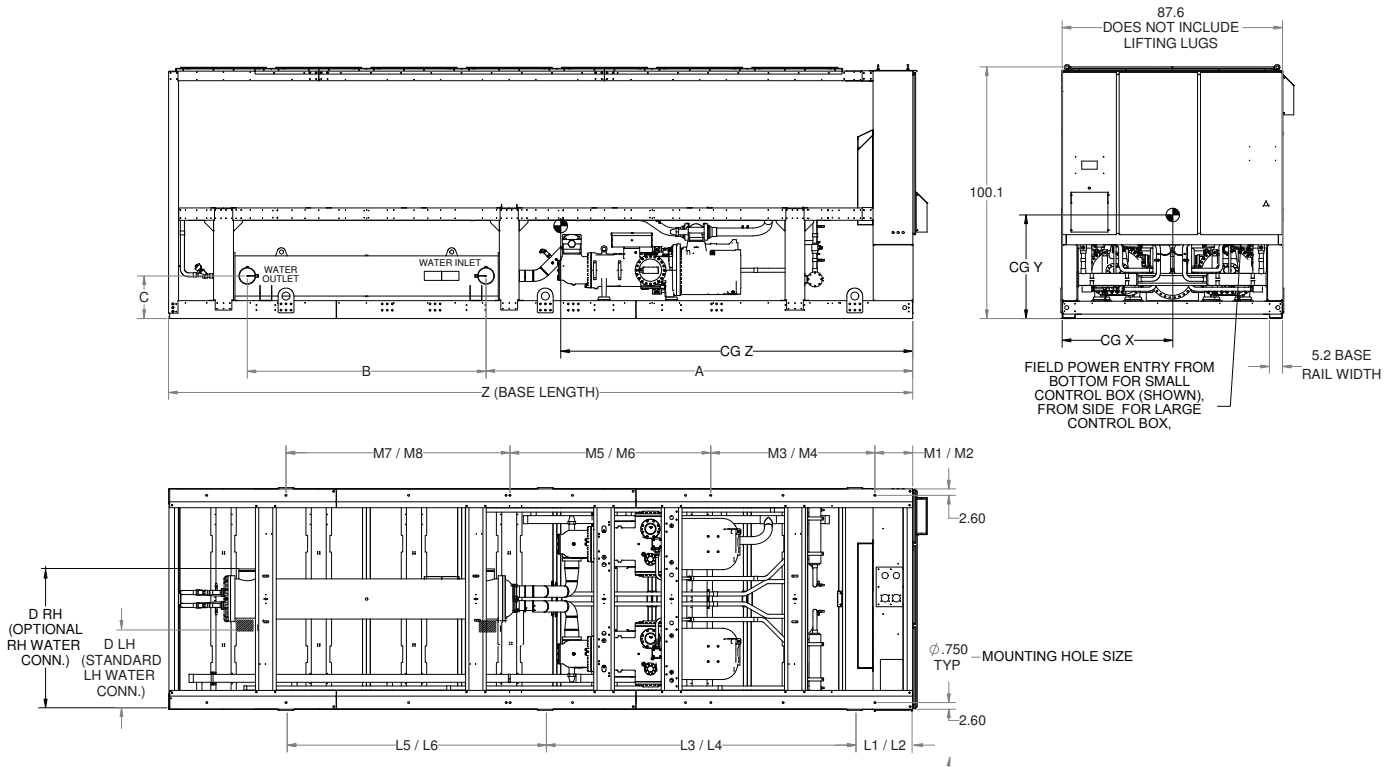
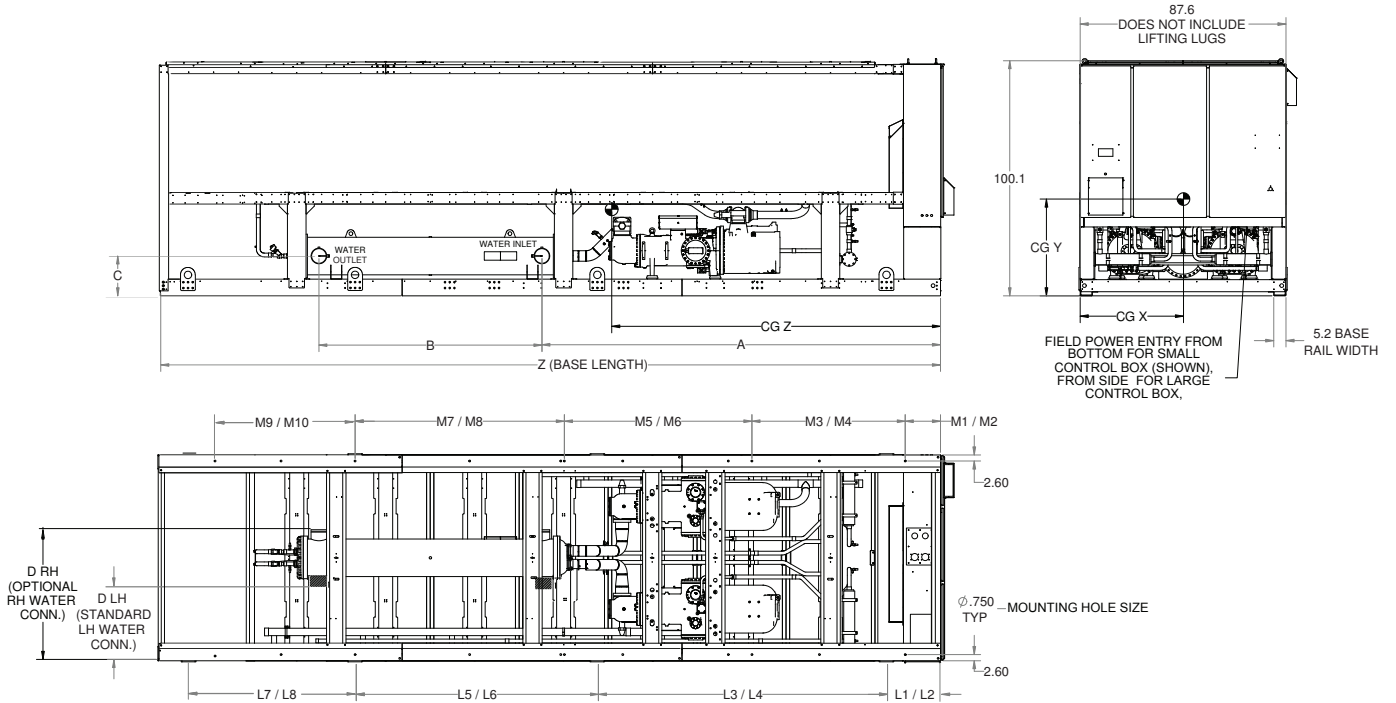

Figure 66: Reference Dimensional Drawing - 16 Fan - 30 Fan Configurations with Shell and Tube Evaporator



NOTE: Water connection sizes are given in Pressure Drop Data starting on [page 46](#).

"L" refers to Lifting Eye Point locations. "M" refers to Mounting Point locations.

IWSE option changes the operational dimensions of the unit; however, added piping is removable, if needed, for installation/service. Consult as-built submittal drawings for dimensional information of units configured with IWSE option.

Table 10: Unit Dimensions by Configuration with Shell and Tube Evaporator

# OF FANS	EVAP	A	B	C	D LH	D RH	Z	CG X	CG Y	CG Z	L1 / L2	L3 / L4	L5 / L6	L7 / L8	M1 / M2	M3 / M4	M5 / M6	M7 / M8	M9 / M10			
12	EV 4027	148.4	95.0	17.0	31.9	55.7	258.1	Refer to Submitted As-Built Drawings			23	121.3	199.6	N/A	15	80.3	135.3	200.5	N/A			
14	EV 4027	169.7	95.0	17.0	31.9	55.7	296				23	146.1	249.3		15	80.3	160.2	249.3				
	EV 5027	171.1	92.9	21.2	29.9	57.8	296															
16	EV 4027	169.7	95.0	17.0	31.9	55.7	334							23	78	190	319.3	15	80.3	135.3	200.5	290.5
	EV 5027	171.1	92.9	21.2	29.9	57.8	334															
	EV 5039	171.1	138.2	21.2	29.9	57.8	334															
18	EV 4027	169.7	95.0	17.0	31.9	55.7	371.7							23	78	190	313	15	80.3	135.3	200.5	310
	EV 5027	171.1	92.9	21.2	29.9	57.8	371.7															
	EV 5039	171.1	138.2	21.2	29.9	57.8	371.7															
20	EV 5027	171.1	92.9	21.2	29.9	57.8	409.6							23	135	209	320	15	80.3	160.2	238	363
	EV 5039	171.1	138.2	21.2	29.9	57.8	409.6															
	EV 6633	175.5	111.4	21.2	26.9	60.1	409.6															
22	EV 5027	171.1	92.9	21.2	29.9	57.8	447.5							23	135	209	365	12	80.3	160.2	280	380
	EV 5039	171.1	138.2	21.2	29.9	57.8	447.5															
	EV 6633	175.5	111.4	21.2	26.9	60.1	447.5															
	EV 6639	173.7	135.0	21.2	26.9	60.1	447.5															
24	EV 5027	171.1	92.9	21.2	29.9	57.8	485.4							23	135	250	400	15	80.3	160.2	280	400
	EV 5039	171.1	138.2	21.2	29.9	57.8	485.4															
	EV 6633	175.5	111.4	21.2	26.9	60.1	485.4															
	EV 6639	173.7	135.0	21.2	26.9	60.1	485.4															
26	EV 6633	175.5	111.4	21.2	26.9	60.1	523.2				23	135	250	400	15	80.3	160.2	280	450			
	EV 6639	173.7	135.0	21.2	26.9	60.1	523.2															
28	EV 6633	175.5	111.4	21.2	26.9	60.1	561.0				23	135	250	447	15	80.3	160.2	280	450			
	EV 6639	173.7	135.0	21.2	26.9	60.1	561.0															
30	EV 6633	175.5	111.4	21.2	26.9	60.1	598.9				23	135	321	488	15	80.3	200	280	490			
	EV 6639	173.7	135.0	21.2	26.9	60.1	598.9															

Isolator Information

Transfer and place the unit as indicated in the Installation section beginning on page 7. In all cases, set the unit in place and level. If anti-skid pads are used, do not use hold down bolts. If hold down bolts are used, do not use anti-skid pads.

Mounting locations for each model configuration can be found in the Dimensional Drawings section beginning on page 42 or in the Submittal As-Built Drawings, available from a Daikin Applied sales representative. Submittal As-Built Drawings also specify the correct isolator color for each mounting location, if ordered.

When spring isolators are required, install springs under the main unit supports. Then unit should be set initially on shims or blocks at the listed spring free height. Isolator springs should not be loaded until all unit installation tasks are complete, then the springs should be adjusted to the vendor listed compression for the load point. When securing the isolator, do not overtighten the mounting bolts. Overtightening may result in cracking of the cast isolator housing and will have a negative impact on the isolation effect.

Installation of spring isolators requires flexible piping connections and at least three feet of flexible electrical conduit to avoid straining the piping and transmitting vibration and noise.

Neoprene waffle pads, supplied by customers, should be mounted at the defined mounting point locations along the full rail width.

Figure 67: Rubber-in-Shear Isolator Schematic

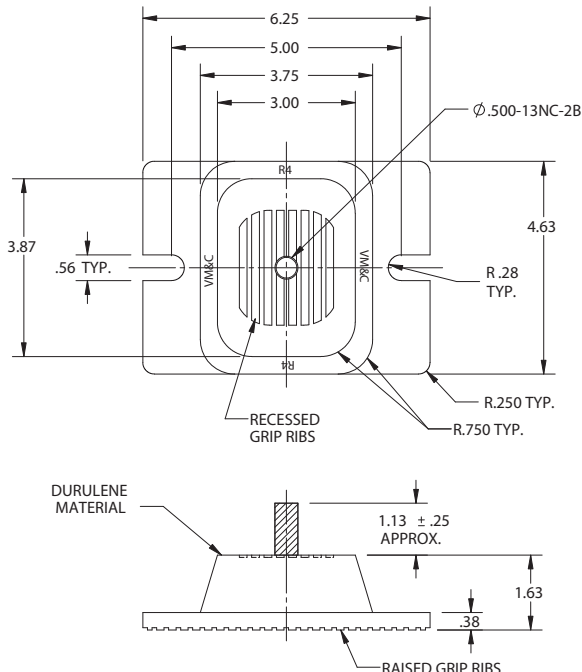

Figure 68: Spring Isolator - 2 Spring Schematic

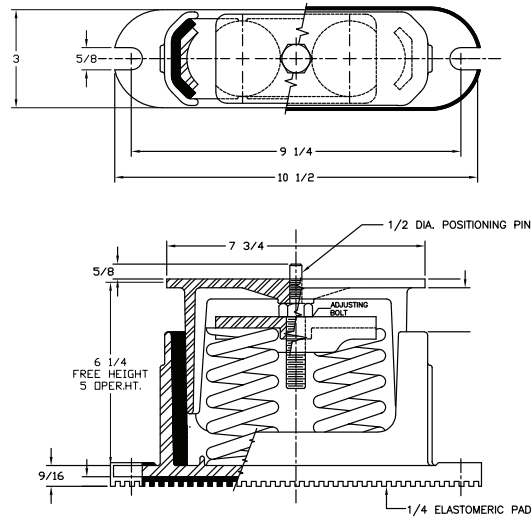

Figure 69: Spring Isolator - 4 Spring Schematic

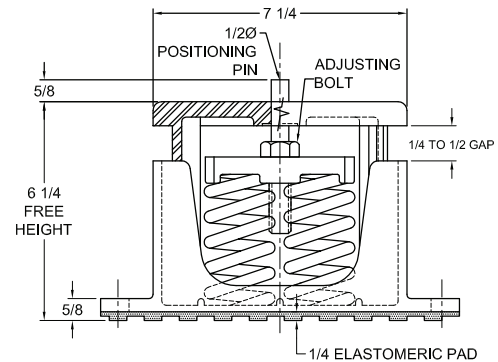
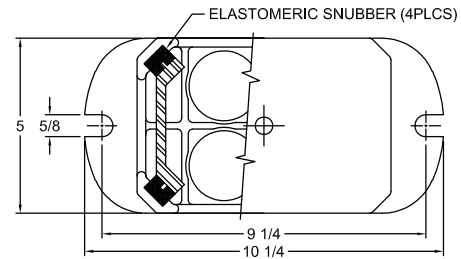

Figure 70: Mounting Location Reference Drawing

AWV - Approximate Mounting Locations
See Dimensional Drawing for exact location



Pressure Drop Data

Table 11: Evaporator Flow Limits

EVAP	Minimum		Maximum	
	gpm	ft H	gpm	ft H
ACH1000DQ-166AH	157.0	1.7	528.0	17.1
ACH1000DQ-206AH	197.0	2.0	660.0	16.9
ACH1000DQ-250AH	239.0	2.0	766.0	16.8
ACH1000DQ-330AH	315.0	2.3	925.0	16.9
EV4027A10/09	148.8	2.1	595.7	26.7
EV4027F10/10	120.5	2.2	585.0	34.5
EV4027A11/07	188.0	2.0	748.0	26.0
EV4027F11/08	152.3	2.2	585.0	21.7
EV4027A12/07	188.0	2.3	748.0	28.1
EV4027F12/08	152.3	2.5	585.0	22.8
EV5027A14/07	219.3	2.4	876.6	28.4
EV5027F14/08	189.8	2.8	774.6	29.6
EV5027A17/05	290.6	2.6	1171.2	30.4
EV5027F17/06	245.5	3.2	1060.0	38.3
EV5039A12/11	207.8	3.0	834.8	35.7
EV5039F12/12	186.5	3.6	766.1	39.7
EV6633A15/07	336.4	2.7	1329.7	30.4
EV6633F15/08	249.9	2.5	1450.0	43.1
EV6633F16/06	301.2	1.5	1395.0	22.2
EV6639A14/11	260.6	3.7	1042.6	40.6
EV6639F14/12	204.6	3.1	958.2	40.6
EV6639A16/09	317.4	3.7	1261.9	41.6
EV6639F16/10	277.6	3.9	1140.2	41.2
EV6639A17/07	398.5	2.7	1586.8	32.3
EV6639F17/08	341.7	3.5	1403.9	37.5

NOTE: Flow rates and pressure drops reflect water only and do not apply to glycol solutions.

Figure 72: Model ACH1000DQ

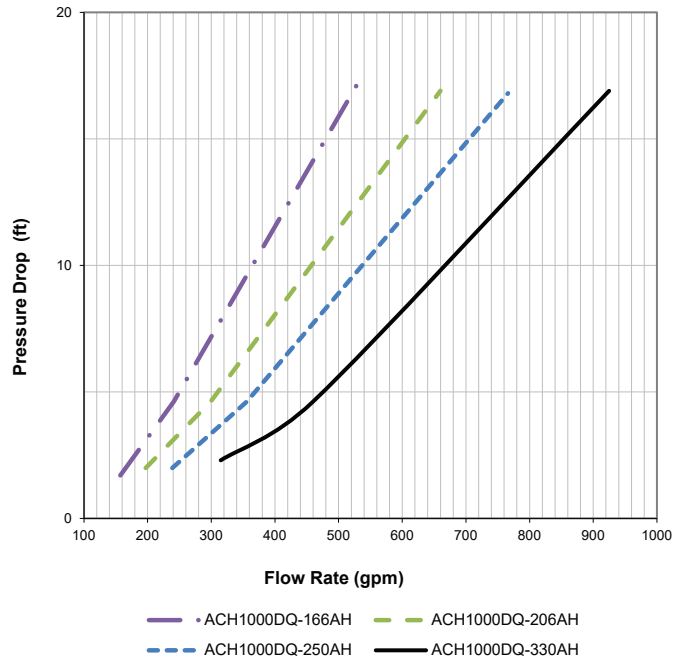

Figure 71: Model EV4027

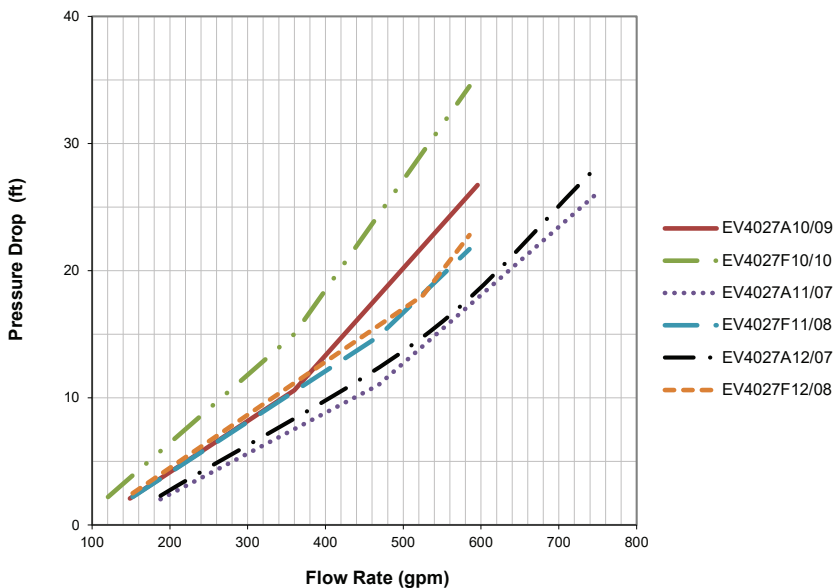

Figure 73: Model EV5027

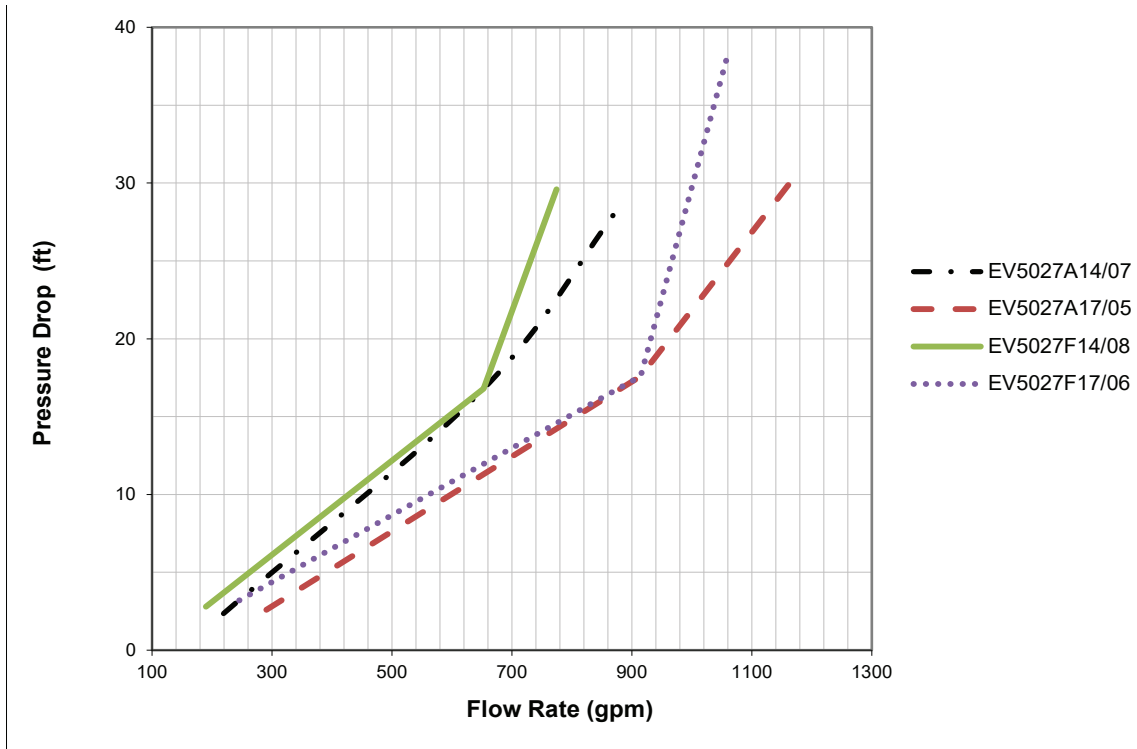

Figure 74: Model EV5039

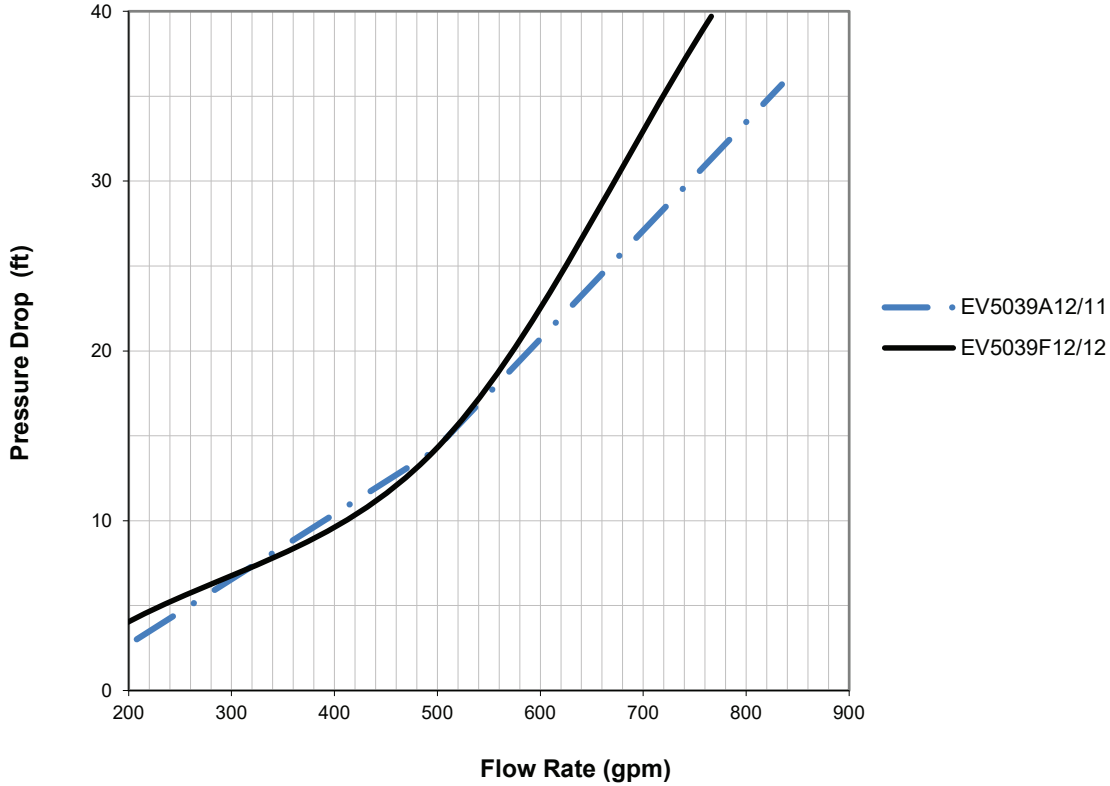

Figure 75: Model EV6633

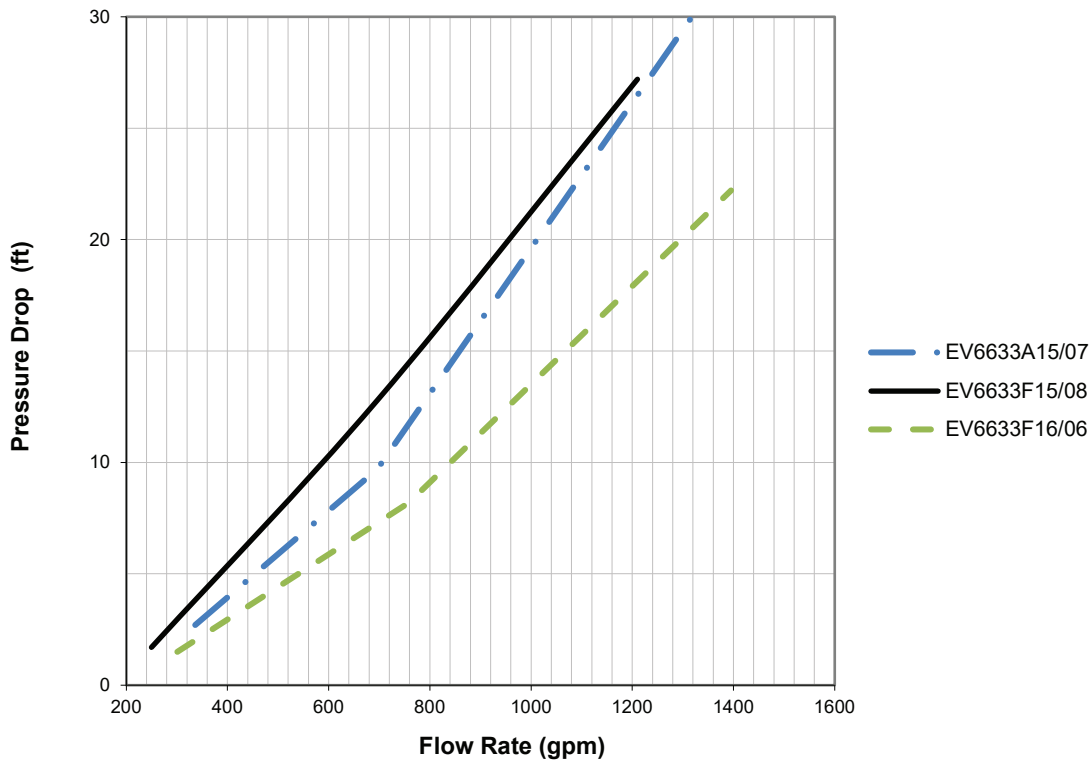
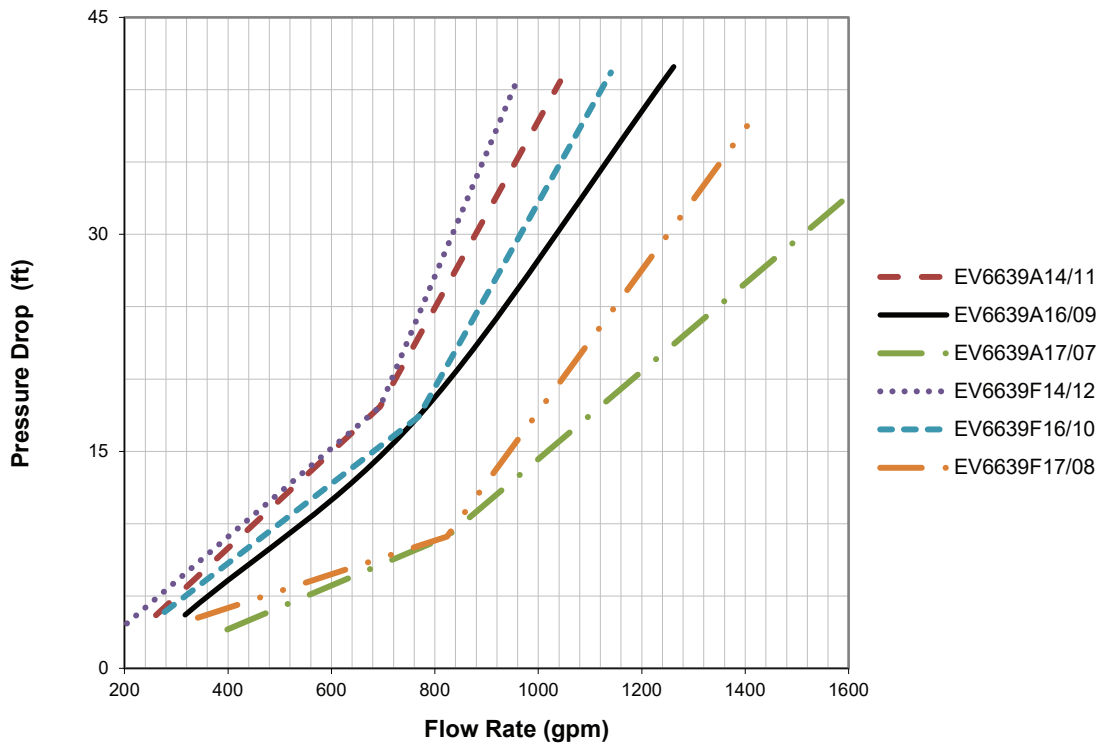

Figure 76: Model EV6639



Controller Operation

Operator Responsibilities

It is important that the operator become familiar with the equipment and the system before attempting operation. During the initial startup of the chiller, the Daikin Applied service technician will be available to answer any questions and instruct the proper operating procedures. It is recommended that the operator maintain an operating log for each individual chiller unit. In addition, a separate maintenance log should be kept of the periodic maintenance and servicing activities.

Operator Schools

Training courses for Pathfinder Air-Cooled Screw Maintenance and Operation are held throughout the year at the Daikin Learning Institute in Verona, Virginia. The class includes instruction on basic refrigeration, MicroTech unit controllers, enhancing chiller efficiency and reliability, MicroTech troubleshooting, system components, and other related subjects. For more information, refer to the back cover of this document for Training contact information.

Software Version

The unit software and BSP (Board Support Package) versions can be viewed using the keypad/display. From the Main Menu, turn the knob to the right to reach the About Chiller menu and press Enter (the knob). The software version is displayed as "App Version =". Scroll down in this menu (turn knob to the right), the BSP version will also be displayed ("BSP Version=").

 WARNING
<p>Electric shock hazard can cause personal injury or equipment damage. This equipment must be properly grounded. Connections to, and service of, the MicroTech unit control panel must be performed only by personnel who are knowledgeable in the operation of this equipment.</p>

 CAUTION
<p>Static sensitive components. A static discharge while handling electronic circuit boards can cause damage to the components. Use a static strap before performing any service work. Never unplug any cables, circuit board terminal blocks, or power plugs while power is applied to the panel.</p>

NOTICE
<p>This equipment generates, uses, and can radiate radio frequency energy and, if not installed and used in accordance with this instruction manual, can cause interference to radio communications. Operation of this equipment in a residential area can cause harmful interference, in which case the user will be required to correct the interference at the user's own expense. Daikin Applied disclaims any liability resulting from any interference or for the correction thereof.</p>

General Description

The MicroTech unit control system consists of a controller and a number of extension input/output (I/O) modules, which vary depending on the unit size and configuration. The control system provides the monitoring and functions required for the controlled, efficient operation of the chiller. The MicroTech unit controllers used on Pathfinder chillers are not interchangeable with previous MicroTech unit controllers.

The operator can see all critical operating conditions by using the screen located on the main controller. In addition to providing all normal operating controls, the MicroTech unit control system will take corrective action if the chiller is operating outside of its normal design conditions.

The control panel is located on the front of the unit at the compressor end. There are three doors. The control panel is behind the left-hand door. The power panels are behind the middle and right-hand doors. The control power transformer is located in the power panel adjacent to the control panel.

Controller Features

- Readout of the following temperature and pressure readings:
 - Entering and leaving chilled water temperature
 - Saturated temperatures and pressures for evaporator and condenser
 - Outside air temperature
 - Suction and discharge temperatures with calculated superheat for discharge and suction lines
 - Oil pressure and temperature
 - Suction and discharge pressure
- Automatic control of primary and standby chilled water pumps. The control will start one of the pumps (based on lowest run-hours) when the unit is enabled to run (not necessarily running on a call for cooling) and when the water temperature reaches a point of freeze possibility.
- Three levels of security protection against unauthorized changing of set points and other control parameters.
- Warning and fault diagnostics to inform operators of conditions in plain language. All events and alarms are time and date-stamped for identification of when the fault condition occurred.
- Twenty-five previous alarms are available.
- Remote input signals for chilled water reset, demand limiting, and unit enable.
- Test mode allows the service technician to manually control the outputs and can be used for a system check.
- Building Automation System (BAS) communication capability via LonTalk®, Modbus®, or BACnet® standard protocols for all BAS manufacturers.
- Pressure transducers for direct reading of system pressures.

NOTICE

The Emergency Switch Relay, located on the front of the control panel door when ordered, de-energizes the control power of all circuits when activated, causing an immediate compressor and fan shutdown.

Modbus Communication - Unit

The unit controller (UC) communicates to the compressor VFD's and the EXV modules via the Modbus RTU connection on the controller itself. Communication to the VFD's and EVAP EXV MODULE is required for operation in all configurations. Communication to ECON EXV MODULE is required only if the chiller is configured with economizers.

System Architecture

The overall controls architecture uses the following:

- One MicroTech unit controller
- I/O extension modules (sometimes referred to as "controllers") as needed depending on the configuration of the unit
- Up to three BAS interface modules as needed based on installed options

Figure 77: System Architecture Schematic

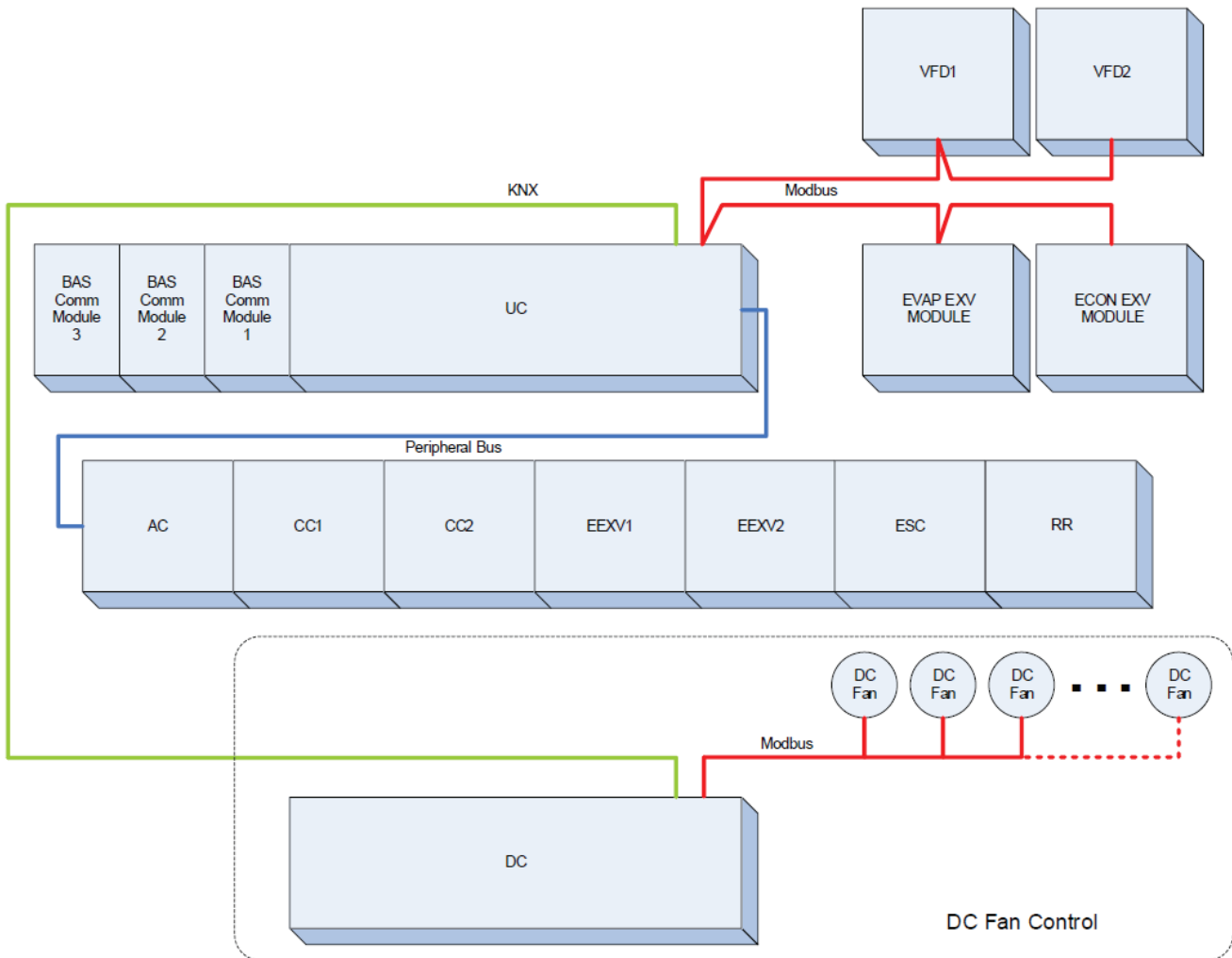

NOTE: Graphic shows typical chiller controller arrangement; individual chiller configurations will be as ordered.

MicroTech Inputs/Outputs

Unit Controller - UC Module

Table 12: Analog Inputs

#	Description	Signal Source
AI1	Evap Entering Water Temp	NTC Thermister (10K@25°C)
AI2	Evap Leaving Water Temp	NTC Thermister (10K@25°C)
AI3	Outside Ambient Temperature	NTC Thermister (10K@25°C)
X1	Waterside Economizer EWT	NTC Thermister (10K@25°C)
X4	LWT Reset	4-20 mA Current

Table 13: Analog Outputs

#	Description	Output Signal
X5	Fan VFD #1	0-10 Vdc
X6	Fan VFD #2	0-10 Vdc

Table 14: Digital Inputs

#	Description	Signal Off	Signal On
DI1	GFP Relay 1	Fault	No Fault
DI2	Evaporator Flow Switch	No Flow	Flow
DI3	Mode Switch	Cool mode	Ice mode
DI4	Remote Switch	Unit disable	Unit enable
DI5	Unit Switch	Unit disable	Unit enable
DI6	Emergency Stop	Unit off	Unit enable
X8	GFP Relay 2	Fault	No Fault

Table 15: Digital Outputs

#	Description	Output OFF	Output ON
DO1	Evaporator Water Pump 1	Pump Off	Pump On
DO2	Alarm Relay	Alarm not Active	Alarm Active
DO3	Circuit #1 Fan Output #1	Fan(s) Off	Fan(s) On
DO4	Circuit #1 Fan Output #2	Fan(s) Off	Fan(s) On
DO5	Circuit #1 Fan Output #3	Fan(s) Off	Fan(s) On
DO6	Circuit #1 Fan Output #4	Fan(s) Off	Fan(s) On
DO7	Circuit #2 Fan Output #1	Fan(s) Off	Fan(s) On
DO8	Circuit #2 Fan Output #2	Fan(s) Off	Fan(s) On
DO9	Circuit #2 Fan Output #3	Fan(s) Off	Fan(s) On
DO10	Circuit #2 Fan Output #4	Fan(s) Off	Fan(s) On

CC Modules - Circuit #1 and #2

Table 16: Analog Inputs

#	Description	Signal Source
X1	Discharge Temperature	NTC Thermister (10K@25°C)
X2	Suction Temperature	NTC Thermister (10K@25°C)
X5	Evaporator Pressure	Ratiometric 0.5-4.5 Vdc
X6	Oil Pressure	Ratiometric 0.5-4.5 Vdc
X7	Condenser Pressure	Ratiometric 0.5-4.5 Vdc

Table 17: Digital Inputs

#	Description	Signal Off	Signal On
X3	Oil Presence Sensor	Oil Not Present	Oil Present

Table 18: Digital Outputs

#	Description	Output Off	Output On
DO1	Compressor Run Command	Compressor Off	Compressor On
DO2	Liquid Line SV	Solenoid Closed	Solenoid Open
DO3	Liquid Injection SV	Solenoid Closed	Solenoid Open
DO4	100% VR SV	Solenoid Closed	Solenoid Open
DO5	75% VR SV	Solenoid Closed	Solenoid Open
DO6	50% VR SV	Solenoid Closed	Solenoid Open
X8	Economizer SV	Solenoid Closed	Solenoid Open

EEXV Modules - Circuit #1 and #2

Table 19: Digital Inputs

#	Description	Signal Off	Signal On
DI1	Mechanical Low Pressure Switch	Fault	No Fault

Table 20: Digital Outputs

#	Description	Output OFF	Output ON
DO1	Economizer SV	Solenoid Closed	Solenoid Open

Table 21: EEXV Stepper Motor Output

#	Description
M1+	Circuit # Evaporator EXV Stepper Coil 1
M1-	
M2+	Circuit # Evaporator EXV Stepper Coil 2
M2-	

Evaporator EXV Module

Table 22: EXV Stepper Outputs

Driver	Description
A	Evaporator EXV Circuit #1
B	Evaporator EXV Circuit #2

Economizer EXV Module

Table 23: Analog Inputs

#	Description	Signal Source
S1	Economizer Pressure Circuit #1	Ratiometric 0.5-4.5 Vdc
S2	Economizer Temperature Circuit #1	NTC 10K Thermister
S3	Economizer Pressure Circuit #2	Ratiometric 0.5-4.5 Vdc
S4	Economizer Temperature Circuit #2	NTC 10K Thermister

Table 24: EXV Stepper Outputs

Driver	Description
A	Economizer EXV Circuit #1
B	Economizer EXV Circuit #2

Economizer 2 Single Module

Table 25: Analog Inputs

#	Description	Signal Source
S1	Economizer Pressure Circuit 1	Ratiometric 0.5-4.5 Vdv
S2	Economizer Temperature Circuit 1	NTC 10k Thermister

Table 26: EXV Stepper Outputs

Driver	Description
A	Economizer EXV Circuit #1

Econ Single Module C2

Table 27: Analog Inputs

#	Description	Signal Source
S1	Economizer Pressure Circuit 2	Ratiometric 0.5-4.5 Vdv
S2	Economizer Temperature Circuit 2	NTC 10k Thermister

Table 28: EXV Stepper Outputs

Driver	Description
A	Economizer EXV Circuit #2

Alarm/Limit Module

Table 29: Analog Inputs

#	Description	Signal Source
X3	Demand Limit	4 to 20 mA
AC X7	Waterside Economizer Valve 1 Position	4 to 20 mA
AC X8	Waterside Economizer Valve 2 Position	4 to 20 mA

Table 30: Analog Outputs

#	Description	Signal Source
AC X2	Waterside Economizer Valve 1 Position Command	4 to 20 mA
AC X4	Waterside Economizer Valve 2 Position Command	4 to 20 mA

Table 31: Digital Inputs

#	Description	Signal Off	Signal On
X1	External Alarm	External Device Failure	External Device OK
X5	Circuit #1 Switch	Circuit Off	Circuit On
X6	Circuit #2 Switch	Circuit Off	Circuit On
DI1	Waterside Econ Enable	Disable	Enable

Table 32: Digital Outputs

#	Description	Output Off	Output On
DO1	Evaporator Water Pump 2	Pump Off	Pump On
DO2	Waterside Economizer Status	Inactive	Active
DO3	Circuit #1 Fan Output #5	Fan(s) Off	Fan(s) On
DO4	Circuit #1 Fan Output #6	Fan(s) Off	Fan(s) On
DO5	Circuit #2 Fan Output #5	Fan(s) Off	Fan(s) On
DO6	Circuit #2 Fan Output #6	Fan(s) Off	Fan(s) On

ESC Module

Table 33: Digital Outputs

#	Description	Output Off	Output On
DO1	Economizer Suction SV Circuit 1	Solenoid Closed	Solenoid Open
DO2	Economizer Discharge SV Circuit 1	Solenoid Closed	Solenoid Open
DO3	Economizer Suction SV Circuit 2	Solenoid Closed	Solenoid Open
DO4	Economizer Discharge SV Circuit 2	Solenoid Closed	Solenoid Open

RapidRestore® Module

Table 34: Digital Inputs

#	Description	Signal Off	Signal On
DI1	RapidRestore Unlock	Lock Out Option	Unlock Option
DI2	Backup Chiller	Normal Chiller	Backup Chiller

Compressor VFDs

Table 35: Digital Inputs

#	Description	Signal Off	Signal On
H1-S6	Circuit # Mechanical High Pressure Switch	Alarm	No Alarm
CN13-1			

NOTE: Signal name is compressor model dependent.

Waterside Economizer Module

Table 36: Analog Inputs

#	Description	Signal Source
UC X1	Waterside Economizer EWT	NTC 10k Thermistor

Table 37: Digital Inputs

#	Description	Signal Off	Signal On
AC DI1	Waterside Economizer Enable	Disable	Enable

Table 38: Digital Outputs

#	Description	Signal Off	Signal On
AC DO2	Waterside Economizer Status	Inactive	Active

Set Points

The following parameters are remembered during power off (permanent memory), are factory set to the Default value, and can be adjusted to any value in the Range column.

Unit Level Set Points

All of these settings require the unit switch to be off in order to make a change and require rebooting the controller in order to apply a change. Unit modes Cool/Ice and Ice will both require Evaporator Glycol set point to have Yes selected.

Table 39: Set Point Default and Range

Description	Default	Range
Basic Unit Configuration		
Refrigerant	Not Set	Not Set, R134a, R513A
Input Voltage	Not Set	Not Set, 380, 400, 460, 575
Evaporator Configuration	Not Set	Not Set, Packaged, Remote
Ground Fault Protection Option	No	No, Single Point, Multi Point
Refrigerant Economizers	Twin	None, Twin, 2 Singles
Refrigerant Economizer Piping	Not Set	Not Set, Steel, Copper
Economizer Check Valves	Not Set	Not Set, No, Yes
Water Side Economizer	No	No, Yes
Liquid Line Solenoid Valves	No	No, Yes
Liquid Injection	No	No, Yes
Condenser Fan Configuration	Not Set	Not Set, No VFD, 1st Fan VFD, All Fan VFD
RapidRestore	No	No, Yes
Evaporator Glycol	No	No, Yes Note: Modes Cool/Ice and Ice will require Evaporator Glycol to be Yes.
Available Modes	Cool	Cool, Cool/Ice, Ice Note: This setting cannot be changed to Cool/Ice or Ice unless the Evaporator Glycol set point is set to Yes. If Available Modes is changed to Cool/Ice or Ice when Evaporator Glycol is set to No, the Available Modes set point should revert back to Cool.
Oil Presence Sensors	Yes	No, Yes
Compressor VFD Type	Not Set	Not Set, Yaskawa, Danfoss
Compressor VFD Parameter Set	No	No, Yes
Circuit #1 Compressor Type	Not Set	Not Set, F3ALVVR60, F3ALVVR86, F3BLVVR86, F4ALVVR80, 3120, 3122
Circuit #2 Compressor Type	Not Set	Not Set, F3ALVVR60, F3ALVVR86, F3BLVVR86, F4ALVVR80, 3120, 3122
Circuit #1 Compressor Max Speed	45 Hz	45 to 60, 45 to 70, 45 to 80, 45 to 86, 45 to 90 - Dependent on type
Circuit #2 Compressor Max Speed	45 Hz	45 to 60, 45 to 70, 45 to 80, 45 to 86, 45 to 90 - Dependent on type
Circuit 1 Compressor VFD Input RLA	100	1 to 1000 amps
Circuit 2 Compressor VFD Input RLA	100	1 to 1000 amps
Circuit #1 Number of Fans	Not Set	Not Set, 4, 6, 8, 10, 12, 14, 16
Circuit #2 Number of Fans	Not Set	Not Set, 4, 6, 8, 10, 12, 14, 16
Circuit #1 Evaporator EXV Type	Not Set	Not Set, E6V, ETS50, ETS100, ETS250, ETS250L, ETS400, ETS400L
Circuit #2 Evaporator EXV Type	Not Set	Not Set, E6V, ETS50, ETS100, ETS250, ETS250L, ETS400, ETS400L
Unit Mode and Enabling		
Unit Enable	Enable	Disable, Enable
Unit Enable Initial Value	Enable	Disable, Enable
Control source	Local	Local, Network
Unit Test Mode	Off	Off, On
Staging and Capacity Control		
Cool LWT	6.67°C (44°F)	See Dynamic Set Point Ranges section
Ice LWT	-3.89°C (25°F)	-8.33°C to -2.22°C (17°F to 28°F)

Description	Default	Range
Startup Delta T	2.7°C (4.9°F)	1.67 to 5.0°C (3 to 9.0°F)
Shut Down Delta T	1.5°C (2.7°F)	0 to 2°C (0 to 3.6°F)
Stage Up Delta T	1.0°C (1.8°F)	0 to 2°C (0 to 3.6°F)
Stage Down Delta T	1.0°C (1.8°F)	0 to 1.7°C (0 to 3.1°F)
Stage Up Delay	3 minutes	0 to 60 minutes
Stage Delay Clear	No	No, Yes
EWT Pulldown Limit Max	3°C/min (5.4°F/min)	2 to 6°C/min (3.6 to 10.8°F/min)
Light Load Stage Down	40%	20 to 50%
High Load Stage Up	80%	50 to 90%
Max Number of Circuits Running	2	1-2
Sequence Number Circuit #1 - #2	1	1-2
Ice Cycle Delay	12	1-23 hours
Clear Ice Delay	No	No, Yes
RapidRestore Max Power Off Time	15 seconds	15 to 180 seconds
Evaporator Pump Control		
Evap Pump Control Configuration	#1 Only	#1 Only, #2 Only, Auto, #1 Primary, #2 Primary
Evap Recirc Timer	90 seconds	0 to 300 seconds
Evap Pump 1 Run Hours	0	0 to 999999 hours
Evap Pump 2 Run Hours	0	0 to 999999 hours
Evap Pump 1 Starts	0	0 to 999999 starts
Evap Pump 2 Starts	0	0 to 999999 starts
Power Conservation and Limits		
LWT Reset Enable	Disable	Disable, Enable
Max Reset	5.0°C (9.0°F)	0 to 10.0°C (0 to 18.0°F)
Demand Limit Enable	Off	Off, On
Water Side Economizer Enable	Yes	No, Yes
Unit Sensor Offsets		
Evap LWT Sensor Offset	0°C (0°F)	-5.0 to 5.0°C (-9.0 to 9.0°F)
Evap EWT Sensor Offset	0°C (0°F)	-5.0 to 5.0°C (-9.0 to 9.0°F)
OAT Sensor Offset	0°C (0°F)	-5.0 to 5.0°C (-9.0 to 9.0°F)
Waterside Economizer EWT Sensor Offset	0°C (0°F)	-5.0 to 5.0°C (-9.0 to 9.0°F)
Circuit Configuration - Applied to All Circuits		
Pumpdown Pressure Max	160 kPa (23.2 psi)	70 to 280 kPa (10.2 to 40.6 psi) Note: The default value for the Pumpdown Pressure Max set point will vary based on the Refrigerant set point: R134A = 160 kPa, R513A = 190 kPa
Pumpdown Time Limit	120 seconds	0 to 180 seconds
Liquid Injection Activation	85.0°C (185.0°F)	50.0°C to 110.0°C (122.0°F to 230.0°F)
Start-Start Time Delay	20 minutes	15-60 minutes
Stop-Start Time Delay	5 minutes	3-20 minutes
Alarm and Limit Settings - Unit		
Evaporator Fluid Freeze	2.2°C (36.0°F)	See Dynamic Set Point Ranges section
Evaporator Flow Loss Delay	15 seconds	5 to 15 seconds
Evaporator Recirculate Timeout	3 minutes	1 to 10 minutes
Low OAT Lockout	See Dynamic Set Point Ranges	See Dynamic Set Point Ranges section
Low OAT Lockout Configuration	Lockout & Stop	Lockout & Stop, Lockout Only, Disabled - not available unless Fan VFD Configuration is 1st Fan VFD or All Fan VFD.
Low OAT Lockout BAS Alert	Off	Off, On
Alarm and Limit Settings - Circuits		
Low Evap Pressure-Unload	160 kPa (23.2 psi)	See Dynamic Set Point Ranges section
Low Evap Pressure-Hold Offset	15 kPa (2.2 psi)	10 to 50 kPa (1.5 to 7.3 psi)
High Oil Press Drop Delay	60 seconds	10-600 seconds
High Discharge Temperature	110.0°C (230.0°F)	65.0 to 110.0°C (149.0 to 230.0°F)
High Cond Pressure Delay	5 seconds	0 to 5 seconds

Description	Default	Range
High Cond Pressure Hold Offset	2.8°C (5°F)	2.8 to 11.1°C (5 to 20°F) - forced to be at least 1.1°C (2°F) greater than High Condenser Pressure Unload Offset.
High Cond Pressure Unload Offset	1.7°C (3°F)	1.7 to 9.4°C (3 to 17°F)
Low Pressure Differential/Ratio Delay	120 seconds	120 to 300 seconds
Low DSH Limit	2.0°C (3.6°F)	1.0°C to 15.0°C (1.8 to 27°F)
Pumpdown Time Limit	120 seconds	0 to 180 seconds
BAS Control Inputs		
Network Unit Enable	Disable	Disable, Enable
Network Mode Command	Cool	Cool, Ice
Network Cool Set Point	6.67°C (44°F)	See Dynamic Set Point Ranges section
Network Ice Set Point	-3.89°C (25°F)	-8.33°C to -2.22°C (17°F to 28°F)
Network Capacity Limit	100%	0% to 100%
Network Alarm Clear Command	Normal	Normal, ClearAlarm
Network Waterside Econ Command	Disable	Disable, Enable

Table 40: Set Points

Description	Default	Range
Unit Test Mode	Off	Off, On
Test Unit Alarm Output	Off	Off, On
Test Evaporator Pump Output 1	Off	Off, On
Test Evaporator Pump Output 2	Off	Off, On

NOTE: Unit test mode set points can be changed only when the unit mode is Test. When the unit mode is no longer Test, all unit test mode set points will be changed back to the 'off' values.

Table 41: Administration and Service Support

Description	Default	Range
Unit G.O. Number	"Enter Data"	Alphanumeric string of up to 16 characters
Unit Serial Number	"Enter Data"	Alphanumeric string of up to 20 characters
Next Maintenance Month	January	January through December
Next Maintenance Year	2009	2009 - 2100
Service Support Reference	999-999-9999	Any 10 digit phone number
Controller Time	From Controller Time clock	00:00:00 to 23:59:59
Controller Date	From Controller Time clock	1/1/2000 to 12/31/2050
UTC Difference	-60 minutes	-3276 to 32767 minutes
Daylight Savings Time Enable	Yes	No, Yes
Daylight Savings Time Start Month	March	January through December
Daylight Savings Time Start Week	2nd Week	1st through 5th Week
Daylight Savings Time End Month	November	January through December
Daylight Savings Time End Week	1st Week	1st through 5th Week
Operator Password Disable	Off	Off, On
Apply Changes	No	No, Yes - Controller should automatically reboot when "Yes"
Active Alarm Clear	Off	Off, On
Alarm Log Clear	No	No, Yes
Alarm Log Export to SD Card	No	No, Yes
Power Restore Event Log - Day Selection	Current	Current, 2nd Day, 3rd Day, 4th Day, 5th Day, 6th Day, 7th Day
Save Settings To SD Card	No	No, Yes
Restore Settings From SD Card	No	No, Yes
Restore Default Settings	No	No, Yes
Display Units	English	English, Metric
I/O Module Address (for reading telegram errors)	0	0 to 255
Reset Telegram Error Counter	Passive	Passive, Active

Dynamic Set Point Ranges

The following settings have different ranges of adjustment based on other settings.

Table 42: Cool LWT Set Point Ranges

Evaporator Glycol	Range
No	4.44 to 21.12°C (40 to 70°F)
Yes	-3.89 to 21.12°C (25 to 70°F)

Table 43: Evaporator Fluid Freeze

Evaporator Glycol	Range
No	1.1 to 6°C (34 to 42.8°F)
Yes	-28.89 to 6°C (-20 to 42.8°F)

Table 44: Low Ambient Lockout Default

Waterside Economizer Option	Default
No	0 °C (32 °F)
Yes	-28.89 °C (-20 °F)

Table 45: Low Ambient Lockout Range

Condenser Fan VFD	Range
None	0 to 15°C (32 to 59°F)
1st Fan VFD, All Fan VFD	-28.89 to 15°C (-20 to 59°F)

NOTE: Unless Low Ambient Lockout is disabled.

Table 46: Low Evaporator Pressure Unload

Evaporator Glycol	Refrigerant	Range
No	R134A	150 to 510 kPa (21.8 to 74 psi)
	R513A	179.7 to 510 kPa (26.1 to 74 psi)
Yes	R34A or R513A	0 to 510 kPa (0 to 74 psi)

Circuit Level Set Point

The settings in this section all exist for each individual circuit.

Description	Default	Range
Mode, Enabling, Configuration		
Circuit Mode	Enable	Disable, Enable, Test
Capacity Control	Auto	Auto, Manual
Manual Speed	See Note 1	
Condenser Control		
Condenser Temp Target Min	23.6°C (74.5°F)	23.6°C to 29.1°C (74.5°F to 84.4°F)
Condenser Temp Target Max	50.0°C (122°F)	30.0°C to 55.0°C (86°F to 131°F)
Fan Staging Deadbands	See Table 47 and Table 48	1 to 10°C (1.8 to 18°F)
Sensor Offsets		
Evap Pressure Offset	0 kPa (0 psi)	-100 to 100 kPa (-14.5 to 14.5 psi)
Cond Pressure Offset	0 kPa (0 psi)	-100 to 100 kPa (-14.5 to 14.5 psi)

Description	Default	Range
Oil Pressure Offset	0 kPa (0 psi)	-100 to 100 kPa (-14.5 to 14.5 psi)
Economizer Pressure Offset	0 kPa (0 psi)	-100 to 100 kPa (-14.5 to 14.5 psi)
Suction Temp Offset	0°C (0°F)	-5.0 to 5.0°C (-9.0 to 9.0°F)
Discharge Temp Offset	0°C (0°F)	-5.0 to 5.0°C (-9.0 to 9.0°F)
Economizer Temp Offset	0°C (0°F)	-5.0 to 5.0°C (-9.0 to 9.0°F)
Administrative and Service Support		
Service Pumpdown	Off	Off, On
Clear Cycle Timers	No	No, Yes
Compressor Run Hours	0	0 to 999999 hours
Compressor Starts	0	0 to 65535
Event Log - Event Selection	Low Pressure Hold	Low Press Hold, Low Press Unload, High Press Hold, Hi Press Unload, Low Pr Diff/ Ratio, VFD Curr Out Hold, VFD Curr Out Unload, VFD Curr In Hold, VFD Curr In Unload, Hi VFD Temp Hold, Hi VFD Temp Unld, Comp Start Fail, VFD Cap Curr Hold, VFD Cap Curr Unload
Event Log - Day Selection	Current	Current, 2nd Day, 3rd Day, 4th Day, 5th Day, 6th Day, 7th Day
Alarm Settings		
High Oil Pressure Drop Minimum	Compressor Dependent	Compressor Dependent

NOTE: 1. Manual Speed value will follow the compressor speed command while Speed Control = Auto. When Speed Control = Manual, the Manual Speed set point can be adjusted. Manual Speed set point should have a maximum value equal to the Maximum Compressor Speed set point for that circuit. Speed Control will return to Auto after 4 hours in Manual.

Fan Staging Deadbands

Fan Stage Deadband settings will only be visible if Fan VFD Configuration is set to None or 1st Fan VFD. The condenser fan staging deadbands have different default values based on the Fan VFD Configuration set point. When that set point is changed, a set of default values for the fan staging deadbands is loaded as shown.

Table 47: Fan VFD Configuration = None

Set Point	Default Value Loaded
Fan Stage Up Deadband 0	4°C (7.2°F)
Fan Stage Up Deadband 1	5°C (9°F)
Fan Stage Up Deadband 2	5.5°C (9.9°F)
Fan Stage Up Deadband 3	6°C (10.8°F)
Fan Stage Up Deadband 4	6.5°C (11.7°F)

Set Point	Default Value Loaded
Fan Stage Up Deadband 5	6.5°C (11.7°F)
Fan Stage Down Deadband 1	10°C (18°F)
Fan Stage Down Deadband 2	8°C (14.4°F)
Fan Stage Down Deadband 3	5.5°C (9.9°F)
Fan Stage Down Deadband 4	4°C (7.2°F)
Fan Stage Down Deadband 5	4°C (7.2°F)

Table 48: Fan VFD Configuration = 1st Fan VFD

Set Point	Default Value Loaded
Fan Stage Up Deadband 0	2.5°C (4.5°F)
Fan Stage Up Deadband 1	2.5°C (4.5°F)
Fan Stage Up Deadband 2	4°C (7.2°F)
Fan Stage Up Deadband 3	5°C (9°F)
Fan Stage Up Deadband 4	4°C (7.2°F)
Fan Stage Up Deadband 5	4°C (7.2°F)
Fan Stage Down Deadband 1	4°C (7.2°F)
Fan Stage Down Deadband 2	3.5°C (6.3°F)
Fan Stage Down Deadband 3	3°C (5.4°F)
Fan Stage Down Deadband 4	2.5°C (4.5°F)
Fan Stage Down Deadband 5	2.5°C (4.5°F)

Circuit Test Mode Set Points

Circuit test mode set points can be changed when either the unit mode is Test, or the circuit mode is Test. When neither the unit nor the circuit are in Test mode, all the circuit test mode set points for the circuit are automatically changed back to their 'off' values.

Description	Default	Range
Test 100% VR Solenoid Output	Off	Off, On
Test 75% VR Solenoid Output	Off	Off, On
Test 50% VR Solenoid Output	Off	Off, On
Test Liquid Line Solenoid Output	Off	Off, On
Test Liquid Injection Solenoid Output	Off	Off, On
Test Evaporator EXV Position	0%	0 to 100%
Test Economizer EXV Position	0%	0 to 100%
Test Condenser Fan Output 1	Off	Off, On
Test Condenser Fan Output 2	Off	Off, On
Test Condenser Fan Output 3	Off	Off, On
Test Condenser Fan Output 4	Off	Off, On
Test Condenser Fan Output 5	Off	Off, On
Test Condenser Fan Output 6	Off	Off, On
Test Condenser Fan VFD Speed	0%	0 to 100%

NOTE: Settings for outputs should be available based on the selected unit configuration settings.

Save and Restore Settings

The ability to save all setting values and restore those values are available to the operator along with the capability to restore the default values.

Saving To SD Card

When the 'Save Settings To SD Card' setting is set to 'Yes', all the setting values should be saved into a file on the SD card. This operation requires that there is an SD Card in the slot on the controller and it is not write protected. When the operation completes, the setting should change back to 'No'.

The settings will be saved on the SD Card in two files: PARAM.BIN and PARAM.UCF. Both files are standalone and contain all the setting values.

Restoring From SD Card

When the 'Restore Settings From SD Card' setting is set to 'Yes', the setting values should be changed to those found in the PARAM.BIN or PARAM.UCF file on the SD card. If both files are on the SD card, the controller will use the PARAM.BIN file. After the setting values are loaded from the SD card, the controller should automatically reboot in order to apply all the setting changes.

Restoring Default Values

When the 'Restore Defaults' setting is set to 'Yes', the setting values should all change back to the original values in the software. After the default values are loaded, the controller should automatically reboot in order to apply all the setting changes.

Unit Functions

Calculations

Evaporator

Error

LWT Error = Evaporator LWT - Active LWT Set Point

Slope

The slope represents the change or trend in either EWT or LWT over a time frame of one minute. It is calculated by taking readings of the temperature every 10 seconds and subtracting them from the previous value, over a rolling one minute interval.

Pulldown Rate

A pulldown rate is calculated by inverting the slope value and limiting to a minimum value of 0°C/min.

Unit

Capacity

The unit capacity is the total of the circuit target capacities divided by the number of circuits. This value represents mechanical cooling capacity of the unit and waterside economizer capacity is not included.

Total Power

An estimate of the total unit power is calculated by adding the power estimate for each circuit. All values are in units of kW.

Unit Enable

Enabling and disabling the chiller is accomplished using set points and inputs to the chiller. The Unit Switch, Remote Switch Input, Unit Enable Set Point, and Siteline Enable input all are required to be On/Enable for the unit to be enabled when the control source is set to 'Local'. The same is true if the control source is set to 'Network', with the additional requirement that the BAS Enable set point must be 'Enable'.

Table 49: Enable Combinations

Unit Switch	Control Source Set Point	Remote Switch Input	Unit Enable Set Point	BAS Enable Set Point	SiteLine Enable Set Point	Unit State
Off	-	-	-	-	-	Disable
-	-	-	Disable	-	-	Disable
-	-	Disable	-	-	-	Disable
-	-	-	-	-	Disable	Disable
On	Local	Enable	Enable	-	Enable	Enable
-	Network	-	-	Disable	-	Disable
On	Network	Enable	Enable	Enable	Enable	Enable

NOTE: A "-" indicates that the value is ignored.

All of the methods for disabling the chiller, discussed in this section, will cause a normal shutdown of any running circuits.

When the controller is powered up, the Unit Enable Set Point will be initialized to Disable if the Unit Enable Initial Set Point is set to Disable. The chiller will remain disabled after powering up until the Unit Enable Set Point is set to Enable.

Unit Mode Selection

The operating mode of the unit is determined by set points and inputs to the chiller. The Available Modes set point determines what modes of operation can be used. This set point also determines whether the unit is configured for glycol use. The Control Source set point determines where a command to change modes will come from. The Mode Switch digital input switches between cool mode and ice mode if they are available and the control source is set to Local. The BAS mode request switches between cool mode and ice mode if they are both available and the control source is set to Network.

The Available Modes Set Point should only be changed when the unit switch is off. This is to avoid changing modes of operation inadvertently while the chiller is running.

Unit Mode is set according to the following table.

Table 50: Unit Mode Combinations

Available Modes Set Point	Control Source Set Point	Mode Switch	BAS Request	Unit Mode
Cool	-	-	-	Cool
Cool/Ice	Local	Off	-	Cool
Cool/Ice	Local	On	-	Ice
Cool/Ice	Network	-	Cool	Cool
Cool/Ice	Network	-	Ice	Ice
Ice	-	-	-	Ice

NOTE: A "-" Indicates that the value is ignored.

Glycol Configuration

If the Available Modes set point is set to an option "w/Glycol," then Evaporator Glycol set point must be selected as Yes. Glycol operation opens up the ranges for several set points to allow lower values.

Unit Control States

The unit will always be in one of three states:

1. Off – Unit is not enabled to run.
2. Auto – Unit is enabled to run.
3. Pumpdown – Unit is doing a normal shutdown.

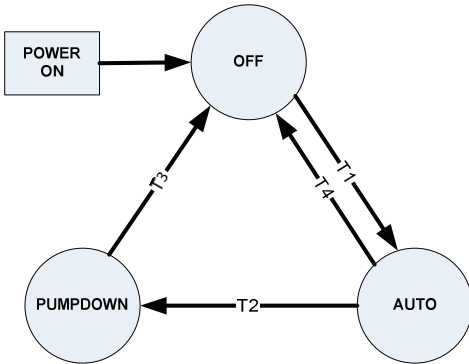

T1 - Off to Auto. All of the following are required:

- Unit is enabled
- No unit alarm requiring shutdown is active
- At least one circuit is enabled to start
- If unit mode = Ice, Ice Delay is not active
- Low Ambient Lockout is not active
- Basic unit configuration is complete
- Control system has rebooted since configuration changed
- If Cond Fan Config = All Fan VFD, DC controller = Auto
- Unit Test Mode is not On
- Controller is not sending compressor VFD configuration

T2 - Auto to Pumpdown. Any of the following are required:

- Unit is disabled
- Unit Mode = Ice and LWT target is reached
- Unit alarm requiring normal shutdown is active
- Low Ambient Lockout is active

T3 - Pumpdown to Off. Any of the following are required:

- Unit alarm requiring rapid shutdown is active
- All circuits complete pumpdown
- Cond Fan Config = All Fan VFD, DC controller = Auto

T4 - Auto to Off. Any of the following are required:

- Unit alarm requiring normal shutdown is active
- No circuits enabled and all circuits in Off state

Unit Status

Unit Status is displayed to indicate the general condition of the unit. The following table lists the text displayed for each unit status and the conditions that enable each status. If more than one status is enabled at the same time, the highest numbered status overrides the others and is displayed.

Table 51: Unit Status Conditions

Enum	Status	Conditions
1	Auto	Unit State = Auto
2	Auto: Sound Reduction	Unit State = Auto and Sound Reduction is active
3	Off: Ice Mode Timer	Unit State = Off, Unit Mode = Ice, and Ice Delay = Active
4	Off: Low OAT Lockout	Unit State = Off and Low OAT Lockout is active
5	Off: DC not ready	Unit State = Off and Low OAT Lockout is active Unit State = Off, Condenser Fan Configuration = All Fan VFD, and DC controller is not in auto control
6	Off: All Cir Disabled	Unit State = Off and all circuits unavailable to start (temporary conditions are not considered)
7	Off: Unit Alarm	Unit State = Off and manual reset Unit Alarm active
8	Off: Keypad Disable	Unit State = Off and Unit Enable Set Point = Disable
9	Off: Remote Switch	Unit State = Off and Remote Switch input is off
10	Off: BAS disable	Unit State = Off, Control Source = Network, and BAS Enable = false
11	Off: Siteline Diable	Unit Status = Off, Sitline Enable input = Disable
12	Off: Unit switch	Unit State = Off and Unit Switch input is off
13	Off: Test Mode	Unit State = Off and Unit Test Mode = On
14	Auto: Wait for Load	Unit State = Auto, no cooling is being provided (either mechanical or WSE), and LWT is less than the active set point + startup delta
15	Auto: Evap Recitculate	Unit State = Auto and Evaporator State = Start
16	Auto: Wait for flow	Unit State = Auto, Evaporator State = Start, and Flow Switch input is off
17	Auto: Pumpdown	Unit State = Pumpdown

Enum	Status	Conditions
18	Auto: Max Circuit Run	Unit State = Auto, Unit Mode = Cool, number of running circuits is limited by the Max Cir Run set point
19	Auto: Unit Cap Limit	Unit State = Auto, unit capacity limit has been met or exceeded
20	Auto: RapidRestore	Unit State = Auto, unit is performing RapidRestore operation
21	Off: Invalid Config	The unit configuration is not a valid combination or not complete.
22	Off: Cfg Chg. Rst Ctr	Unit configuration set point has changed, and reboot of controller is required
23	Off: Sending VFD Config	Controller is configuring the compressor VFD's (Yaskawa only) via Modbus communication.

Ice Mode Start Delay

An adjustable start-to-start Ice Cycle Delay timer will limit the frequency with which the chiller may start in Ice Mode. The timer starts when the first compressor starts while the unit is in Ice Mode. While this timer is active, the chiller cannot restart in Ice Mode. The time delay is user adjustable. The Ice Cycle Delay timer may be manually cleared to force a restart in Ice Mode. A set point specifically for clearing the Ice Cycle Delay is available, Clear Ice Delay. Cycling controller power will also clear the timer.

Low Ambient Lockout

The operation of the chiller in response to OAT dropping below the Low OAT Lockout set point is configurable if the Fan VFD Configuration set point is set to 1st Fan VFD or All Fan VFD. In that case, there are three options:

- Lockout and Stop – chiller will shut down and lockout
- Lockout only – chiller does not shut down running circuits, will lock out circuits that are off
- Disabled – chiller does not shut down or lock out

If the Fan VFD Configuration set point is set to None, there is no configuration and the chiller will always operate according to the first option shown above. Descriptions of the operation for each option are in the following sections.

Lockout and Stop Operation

If the OAT drops below the low ambient lockout set point and the OAT sensor fault is not active, then low ambient lockout is triggered. The unit will go into the pumpdown state if any circuits are running. If no circuits are running the unit will go directly into the off state. Once all circuits complete pumpdown, the unit will remain in the off state until the lockout has cleared. This condition will clear when OAT rises to the lockout set point plus 2.5°C (4.5°F).

Lockout Only Operation

If OAT drops below the low ambient lockout set point and any circuits are running, then those circuits will be allowed to remain running and the unit will not enter the low ambient lockout condition. Circuits that are not running will enter a circuit level lockout condition when OAT drops below the lockout set point. This condition will clear at the circuit level when OAT rises to the lockout set point plus 2.5°C (4.5°F).

If the OAT is below the low ambient lockout set point, the OAT sensor fault is not active, and no circuits are running, then low ambient lockout is triggered. The unit will go directly into the off state and will remain in the off state until the lockout has cleared. This condition will clear when OAT rises to the lockout set point plus 2.5°C (4.5°F).

Disabled Operation

When low ambient lockout is disabled, the unit will not enter the low ambient lockout condition or shut down any running circuits, regardless of the OAT.

BAS Annunciation

Low Ambient Lockout is not an alarm, but it can be annunciated to the BAS as if it is one. When the Low OAT Lockout BAS Alert set point is set to On and the low ambient lockout is active, the following will occur:

- Chiller alarm status parameter will show alarm state
- Active Problem Alarm Code will be set to 16642 (assuming no higher code is active)
- Active Problem Alarm Index will be set to 65 (assuming no higher index is active)
- Digital parameter AmbTempLow will show alarm state
- Intrinsic alarming will show low ambient temperature via the LowOATemp object

Evaporator Pump Control

Only one source can be in control of the pumps at any given time. Three evaporator pump control states for control of the evaporator pumps:

1. Off - No pump on.
2. Start – Pump is on, water loop is being recirculated.
3. Run – Pump is on, water loop has been recirculated, and circuits can start if needed.

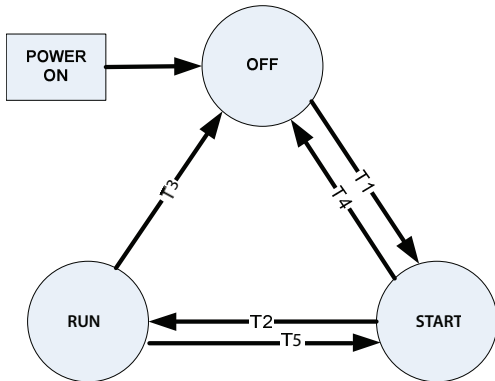

T1 - Off to Start - All of the following are required:

- Unit state = Auto
- Freeze protection started

T2 - Start to Run - Requires the following to be true:

- Flow ok for time longer than evaporator recirculate time set point

T3 - Run to Off - Requires all of the following to be true:

- Unit state = Off
- Freeze protection not active

T4 - Start to Off - Requires all of the following to be true:

- Unit state = Off
- Freeze protection not active

T5 - Run to Start - Requires the following to be true:

- Flow switch input is low for longer than the flow proof set point

Freeze Protection

To protect the evaporator from freezing, the evaporator pump will start if the manual reset flow loss alarm is not active and either of the following are true:

- LWT equal to or less than the Evap Freeze set point for at least three seconds and LWT sensor fault is not active
- EWT equal to or less than the Evap Freeze set point for at least three seconds and EWT sensor fault is not active

Freeze protection will end when manual reset flow loss alarm is active or all of the following are true:

- LWT is at least 1.11°C (2°F) above the Evap Freeze set point or LWT sensor fault is active
- EWT is at least 1.11°C (2°F) above the Evap Freeze set

point or EWT sensor fault is active

- Pump has been running for at least 15 minutes

Pump Selection

The pump output used when evaporator state is Run will be determined by Evap Pump Control set point. This setting allows the following configurations:

- #1 only – Pump 1 will always be used
- #2 only – Pump 2 will always be used
- Auto – The primary pump is the one with the least run hours, the other is used as a backup
- #1 Primary – Pump 1 is used normally, with pump 2 as a backup
- #2 Primary – Pump 2 is used normally, with pump 1 as a backup

Primary/Standby Pump Staging

The pump designated as primary will start first. If the evaporator state is Start for a time greater than the recirculate timeout set point and there is no flow, then the primary pump will shut off and the standby pump will start. When the evaporator is in the run state, if flow is lost for more than half of the Flow Loss Delay set point value, the primary pump will shut off and the standby pump will start. Once the standby pump is started, the flow loss alarm logic will apply if flow cannot be established in the evaporator start state, or if flow is lost in the evaporator run state.

Auto Control

If auto pump control is selected, the primary/standby logic above is still used. When the evaporator is not in the run state, the run hours of the pumps will be compared. The pump with the least hours will be designated as the primary at this time.

Leaving Water Temp (LWT) Reset

LWT Target

The evaporator LWT Target varies based on settings and inputs and is selected as follows:

Table 52: LWT Targets Control Source

Available Modes Set Point	Control Source Set Point	Mode Switch	BAS Mode Command	BAS LWT Target
Cool	Local	-	-	Cool LWT Set Point
Cool	Network	-	-	BAS Cool Set Point
Cool/Ice	Local	Off	-	Cool LWT Set Point
Cool/Ice	Local	On	-	Ice LWT Set Point
Cool/Ice	Network	-	Cool	BAS Cool Set Point
Cool/Ice	Network	-	Ice	BAS Ice Set Point
Ice	Local	-	-	Ice LWT Set Point
Ice	Network	-	-	BAS Ice Set Point

The base LWT target may be reset to a higher value if the unit is in Cool Mode and it is configured for a reset. The type

of reset to be used is determined by the LWT Reset Type set point.

When the active reset increases, the Active LWT Target is changed at a rate of 0.1°C (0.18°F) every 10 seconds. When the active reset decreases, the Active LWT Target is changed all at once.

After resets are applied, the LWT target can never exceed a value of 21.12°C (70°F). Since the Cool LWT set point can be set as high as 21.12°C, the amount of reset may be limited in order to meet this requirement to clamp the active LWT target to 21.12°C.

Reset Type – None

The Active LWT target is set equal to the base LWT target.

4-20 mA External Signal Reset

The Active LWT target is adjusted by the 4-20 mA reset analog input. Parameters used:

1. Max Reset set point
2. LWT Reset signal

Reset is 0 if the reset signal is less than or equal to 4 mA. Reset is equal to the Max Reset Delta T set point if the reset signal equals or exceeds 20 mA. The amount of reset will vary linearly between these extremes if the reset signal is between 4 mA and 20 mA. An example of the operation of 4-20 mA reset in Cool Mode follows.

Figure 78: 4-20 mA Reset - Cool Mode

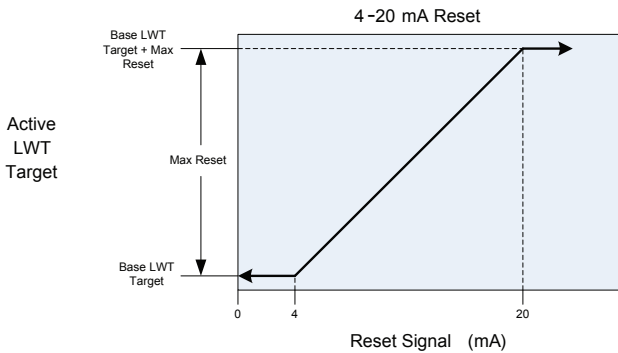

Unit Capacity Control

Unit capacity control will be performed as described in this section. A combination of starting/stopping compressors and loading/unloading compressors is used to control the overall unit capacity.

Maximum Circuits Running

If the number of compressors running is equal to the Max Circuits Running set point, no additional compressors should be started. This applies in both Cool Mode and Ice Mode operation.

When both circuits are running and the Max Circuits Running set point is changed to one, a circuit should shut down.

Cool Mode Operation

In Cool Mode, unit capacity is adjusted via circuit staging and capacity changes on each circuit. LWT error and EWT pulldown rate are the primary factors in unit capacity adjustments. This section details all the logic for unit capacity control in Cool Mode.

Staging Sequence

This section defines which circuit is the next one to start or stop if the logic does not call for simultaneous start or stop of both circuits. In general, circuits with fewer starts will normally start first, and circuits with more run hours will normally stop first. Staging sequence can also be determined by an operator defined sequence via set points.

The next circuit to start must meet the following requirements:

Lowest sequence number of those circuits available to start

- if sequence numbers are equal, it must have the least starts
- if starts are equal, it must have least run hours
- if run hours are equal, it must be the lowest numbered circuit

The next circuit to shut down must meet the following requirements:

Lowest sequence number of the circuits that are running

- if sequence numbers are equal, it must have the most run hours
- if run hours are equal, it must have the least starts
- if starts are equal, it must be the lowest numbered circuit

Load/Unload Sequence

This section defines which circuit is the next one to load or unload if the logic does not call for simultaneous load or unload of both circuits.

The next circuit to load must meet the following requirements:

Lowest capacity of the running circuits

- if capacities are equal, it must have the lowest sequence number of the circuits that are running
- if the sequence numbers are equal, it must have the least starts
- if starts are equal, it must have the least run hours
- if run hours are equal, it must be the lowest numbered circuit

The next compressor to unload must meet the following requirements:

Highest capacity of the running compressors

- if capacities are equal, it must have the lowest sequence number of the compressors that are running
- if sequence numbers are equal, it must have the most run hours
- if run hours are equal, it must have the least starts
- if starts are equal, it must be the lowest numbered compressor

Stage Up Delay

Any time the number of running circuits changes, the stage up delay will start and run for a time equivalent to the Stage Up Delay set point.

Any time there are no circuits running, the stage up delay will be cleared.

For the purpose of this section, a “running” circuit is a circuit in the Preopen, Start, or Run state.

Staging Circuits On

Unit capacity control will command at least one circuit to start if all of the following are true:

- Unit State = Auto
- Evaporator Pump State = Run
- LWT error > Startup Delta T set point
- Pulldown Hold is not active

Both circuits are able to start at the same time if the following conditions are true (in addition to the above conditions):

- Demand limit > 40% if Demand Limit = Enable
- Network limit set point > 40% if Control Source = Network

If one circuit is running, unit capacity control will command the second circuit to start if all of the following are true:

- One circuit running at full capacity (see circuit details for determination of full capacity)
- Stage Up Delay has completed
- LWT Error > Stage Up Delta T set point
- Capacity Increase command is active
- Max Number Circuits Running set point = 2

Staging Circuits Off

Unit capacity control will command a single circuit to shut down if both circuits are running and any of the following are true:

- LWT error < - (Stage Down Delta T set point)
- LWT error < Stage Up Delta T set point, both circuits speed < Light Load Stage Down set point, and neither circuit has an active capacity hold event
- A unit capacity limit is active, both circuits capacity < Light Load Stage Down set point, and neither circuit has an active capacity hold event
- Max Number Circuit Running set point changes to 1

If one circuit is running the capacity control logic will command it to shut down if the following conditions are true for 15 minutes:

- Compressor running at 14 Hz
- LWT Error < -0.4°C

Unit capacity control will command all circuits to shut down if LWT Error < - (Shut Down Delta T set point).

Circuit Capacity Change Commands

Load commands are issued when the following are true:

- LWT Error > Load Deadband
- Time > Load Delay has passed since the last unit capacity increase
- EWT Pulldown Rate Hold is not active

Unload commands are issued when:

- Either LWT Error < - (Unload Deadband), or EWT Pulldown Rate Unload is active
- Time > Load Delay has passed since the last unit capacity decrease

Load Balancing

In Cool Mode, capacity of the circuits is controlled so that when possible their capacities are balanced. Circuits will generally maintain a capacity imbalance that does not exceed 15%.

If a capacity change has not occurred for at least one minute and the difference in capacity between the two running circuits is more than 15%, then the circuit capacities will be adjusted. The circuit at the lower capacity will load and the circuit at the higher capacity will unload simultaneously.

If either circuit is running in manual capacity control or running with active capacity limiting events, then no load balancing adjustments will be made.

Ice Mode Operation

In Ice Mode, running circuits will load up simultaneously at the maximum possible rate that allows for stable operation of the individual circuits.

Staging Of Circuits

Both circuits should start when LWT error is greater than the Startup Delta T set point and the Max Circuits Running set point is set to 2. If only one circuit can start, the other circuit should start as soon as possible after the stage up delay has expired.

Both circuits should be staged off when LWT error is 0 or less.

Unit Capacity Limits

Unit capacity limits are used to limit total unit capacity in Cool Mode only. Multiple limits may be active at any time, and the lowest limit is always used in the unit capacity control.

Soft load, demand limit, and network limit use a deadband around the actual limit value, such that unit capacity increase is not allowed within this deadband. If unit capacity is above the deadband, capacity is decreased until it is back within the deadband, which is 8%.

The unit capacity will be adjusted as needed via circuit staging and capacity changes to meet the lowest active limit, but the last running compressor cannot be turned off to meet a limit lower than the minimum unit capacity.

Demand Limit

The maximum unit capacity can be limited by a 4-20 mA signal on the Demand Limit analog input at the unit controller. This function is only enabled if the Demand Limit set point is set to ON.

As the signal varies from 4 mA up to 20 mA, the maximum unit capacity changes from 100% to 0%.

Network Limit

The maximum unit capacity can be limited by a network command. This function is only enabled if the unit control source is set to Network. The signal will be received through the BAS interface on the unit controller.

This network limit command directly sets a maximum unit capacity from 0% to 100%.

RapidRestore®

The option allows the capability to restart more quickly and to load faster than normal when power is lost and restored.

Enabling

Changing the RapidRestore® set point to Enable will require the following to be true:

- RapidRestore® module is present at address 22
- DI1 on the RapidRestore® module has a signal

If any of the above are no longer true, the RapidRestore® set point will be changed to Disable.

Operation Following Cycling of Power

The chiller will enter RapidRestore® upon powering up when the following conditions are met:

- RapidRestore® is enabled
- Power failure lasts less than the value of the Max Power Failure Time set point
- Power failure lasts at least one second
- Unit is enabled
- LWT Error is at least equal to the Stage Up Delta T set point

RapidRestore® will end if any of the following conditions occur:

- LWT Error is less than the Stage Up Delta T set point
- Unit capacity = 100%
- All circuits become disabled for any reason
- Unit becomes disabled for any reason
- 10 minutes have passed since unit powered up

Unit Level Changes

During RapidRestore® operation, unit capacity control logic allows both circuits to start simultaneously.

In the event that both circuits do not start simultaneously, the requirement for the running circuit to reach maximum capacity will be ignored for staging the other circuit on.

Circuit Level Changes

When RapidRestore® is triggered, all compressor cycle timers are cleared to allow for starting more quickly. The limit of four starts per hour will remain in effect and will not be cleared by triggering RapidRestore®.

Waterside Economizer

The waterside economizer (WSE) option will be considered available if the following conditions are all true:

- Waterside Economizer Option set point = Yes
- Waterside Economizer Enable DI is on
- Waterside Economizer Enable set point = Yes
- If Control Source = Network and it is NOT configured with LON, then BAS Waterside Economizer Command = Enable
- WSE EWT sensor fault alarm, WSE Valve Problem alarm, and WSE Valve Fault alarm are not active
- Unit Mode = Cool

NOTE: WSE parameters are not available on LON, so the BAS WSE Command setting cannot be set with LON and therefore must be ignored.

When the WSE loop is active, WSE Capacity =

$$\frac{[(\text{Cir 1 Num Fans Running} - 1) + (\text{Cir 1 Fan Speed} \div 100) + (\text{Cir 2 Num Fans Running} - 1) + (\text{Cir 2 Fan Speed} \div 100)]}{\text{Total Number of Fans}}$$

WSE Cooling States

Off: No cooling is being provided

Waterside Economizer: Only cooling via waterside economizer is provided

Hybrid Cooling Pulldown: Cooling via both mechanical cooling and waterside economizer are being provided, during loop pulldown phase of run cycle

Hybrid Cooling Modulation: Cooling via both mechanical cooling and waterside economizer are being provided, after loop has been pulled down.

Mechanical Cooling: Only cooling via mechanical cooling is being provided

Operation in Off State

When cooling state is Off:

- Waterside Economizer Valve 1 should be fully open.
- Waterside Economizer Valve 2 should be fully closed.
- No condenser fans will run.
- No compressors will run.

Operation in Waterside Economizer State

When cooling state is Waterside Economizer:

- Waterside Economizer Valve 1 should be fully closed.
- Waterside Economizer Valve 2 should be fully opened.
- Condenser fans may be running for the purpose of WSE only.
- No compressors will run.

Operation in Hybrid Cooling - Pulldown State

When cooling state is Hybrid Cooling – Pulldown:

- Waterside Economizer Valve 1 should be fully closed.
- Waterside Economizer Valve 2 should be fully opened.
- Condenser fans may be running for the primary purpose of condenser pressure control on a circuit running a compressor. Any WSE effect from running fans is secondary.
- One or both compressors may be running.

Fans on a circuit running the compressor should operate the same as they normally do (based on condenser pressure control). Fans on a circuit NOT running the compressor should all remain off in this state so that the circuit is ready to start as needed.

Operation in Hybrid Cooling - Modulation State

When cooling state is Hybrid Cooling – Modulation:

- Waterside Economizer Valve 1 should be fully closed.
- Waterside Economizer Valve 2 should be fully opened.
- Condenser fans may be running for the purpose of condenser pressure control on a circuit running a compressor or for the sole purpose of WSE effect.
- One or both compressors may be running.

Operation in Mechanical Cooling State

When cooling state is Mechanical Cooling:

- Waterside Economizer Valve 1 should be fully opened.
- Waterside Economizer Valve 2 should be fully closed.
- Condenser fans may be running only for the purpose of condenser pressure control on a circuit running a compressor. No condenser fans should be running for the purpose of WSE.

Capacity Control in Waterside Economizer State

This section describes the operation of condenser fans when the cooling state is Waterside Economizer. Fan control includes fan staging and fan speed control. The general concept is to stage fans to control WSE capacity and trim the capacity with the fan variable speed drives.

During Waterside Economizer state, if a circuit is disabled then it should not run the fans for WSE.

If transition from Hybrid Cooling to Waterside Econ occurs, fans may start staging on during pumpdown of running circuit(s).

During Waterside Economizer state, the Evaporator EWT will be controlled rather than the Evaporator LWT. This is because of the lag that occurs in the Evaporator LWT when WSE capacity changes.

Calculated Values

WSE Delta T = WSEEWT – EEWT

LWT Error = EEWT – Active Set Point

Capacity Control In Hybrid Cooling Modulation State

Fans on a circuit running the compressor should operate mostly the same as they normally do (based on condenser pressure control). The exception is that reductions in the Saturated Condenser Temperature Target should be at a controlled rate of 0.1°C every 30 seconds.

Fans on a circuit NOT running the compressor should all be turned on if that circuit is enabled to run but not all at once upon entering the Hybrid Cooling Modulation state. After the cooling state is Hybrid Cooling Modulation for five minutes the fans on a circuit not running the compressor can start turning on. A minimum of 20 seconds should pass between fan stage increases and it should only increase if LWT Error is within the dead band calculated for unloading the running compressor (this is to make sure the running compressor is given a chance to unload in compensation for adding WSE capacity).

In Hybrid Cooling Modulation state, the compressor capacity control logic should operate normally except for one change. When the estimated full capacity delta t is calculated for the purpose of establishing the load and unload deadbands, that calculation should be based on the total delta t rather than just the evaporator temperature delta.

Circuit Functions

Circuit Functions

Components controlled at the circuit level include:

- Compressor VFD
- Compressor VR Solenoid Valves
- Evaporator EXV
- Economizer EXV
- Liquid Line Solenoid Valve
- Liquid Injection Solenoid Valve
- Condenser Fans

Calculations

Calculations are for each circuit.

Approach Values

Evaporator Approach = LWT – Evap Saturated Temp

Condenser Approach = Cond Saturated Temp – OAT

Superheat Values

Suction superheat = Suction Temp – Evap Saturated Temp

Discharge superheat = Discharge Temp – Cond Saturated Temp

Economizer Superheat = Econ Temp – Econ Saturated Temp

Differential Pressure Values

Oil Pressure Differential = Cond Pressure - Oil Pressure

Pressure Difference = Cond Pressure – Evap Pressure

Pressure Ratio

Pressure Ratio = (Cond Press + 101.325) ÷ (Evap Press + 101.325)

Feedback Capacity

Feedback capacity is a representation of the actual capacity as a percentage of full capacity based on feedback regarding the actual speed of the compressor.

Compressors vary capacity via changes to the speed. The actual compressor speed is read from the VFD. Feedback capacity for a compressor with a VFD is:

Actual Compressor Speed x 100 ÷ Maximum Speed

Saturated Condenser Temperature Limit

The maximum saturated condenser temperature calculation is based on the compressor operational envelope. This value is used for triggering high condenser pressure alarms and as a reference for the trigger values of the high pressure hold and unload events. Chiller software is designed to calculate a dynamic maximum saturated condenser temperature. High saturated condenser hold and unload offset values are described as follows.

Table 53: Saturated Condenser Temperature Conditions

Condition	Saturated Evap Temp or LWT	Max Cond Saturated Temp (°C)
EXV state is Start Pressure Control	LWT ≤ 0°C	1.589 X LWT + 68.3
	LWT > 0°C	68.3
EXV state is SSH or MOP Control	Te ≤ 0°C	1.589 X Te + 68.3
	Te > 0°C	68.3
All other conditions	n/a	68.3

High Saturated Condenser – Hold Value

High Cond Hold Value = Max Saturated Cond Value – High Cond Press Hold Offset set point

High Saturated Condenser – Unload Value

High Cond Unload Value = Max Saturated Cond Value – High Cond Press Unload Offset set point

Maximum Compressor VFD Output Current

Max Motor Current = Minimum of (VFD Rated Current, Motor Rated Current)

where:

- VFD Rated Current is read from the compressor VFD
- Motor Rated Current is determined by the compressor type and the voltage configuration:

Compressor Type	Motor Rated Current (Amps)			
	380V	400V	460V	575V
F3ALVVR60	222.8	222.8	183.3	167.0
F3ALVVR86	375.6	375.6	311	253.5
F3BLVVR86	527.9	527.9	434.1	N/A
F4ALVVR80	692.1	692.1	574.8	N/A
3120	175	175	175	175
3122	230	230	230	230

Pumpdown Target Value

The pressure target for pumpdown when the circuit enters the pumpdown state is selected as follows:

If Service Pumpdown set point = Disable

Then Pumpdown Target = Evaporator Pressure at pumpdown start – 20 kPa with value limited to the range from 35 kPa to the Pumpdown Pressure Max set point

If Service Pumpdown set point = Enable

Then Pumpdown Target = 35 kPa

Circuit Availability

A circuit is available to start if the following conditions are true:

- Circuit switch input is on
- No manual reset circuit fault alarms are active
- Circuit Mode set point is set to Enable
- BAS Circuit Mode set point is set to Auto
- No cycle timers are active
- Oil Sump Check = Ready

Oil Sump Check

Oil sump check is to make sure that oil in the sump is of sufficient quality prior to starting the compressor.

Oil sump check is set to Ready when
 $Discharge\ Temperature > Saturated\ Oil\ Temperature + 5^{\circ}C$

Oil sump check is set to Not Ready when
 $Discharge\ Temperature < Saturated\ Oil\ Temperature + 4.5^{\circ}C$

Circuit States

There are five distinct states of control for the circuit as shown.

Figure 79: Circuit State Transitions

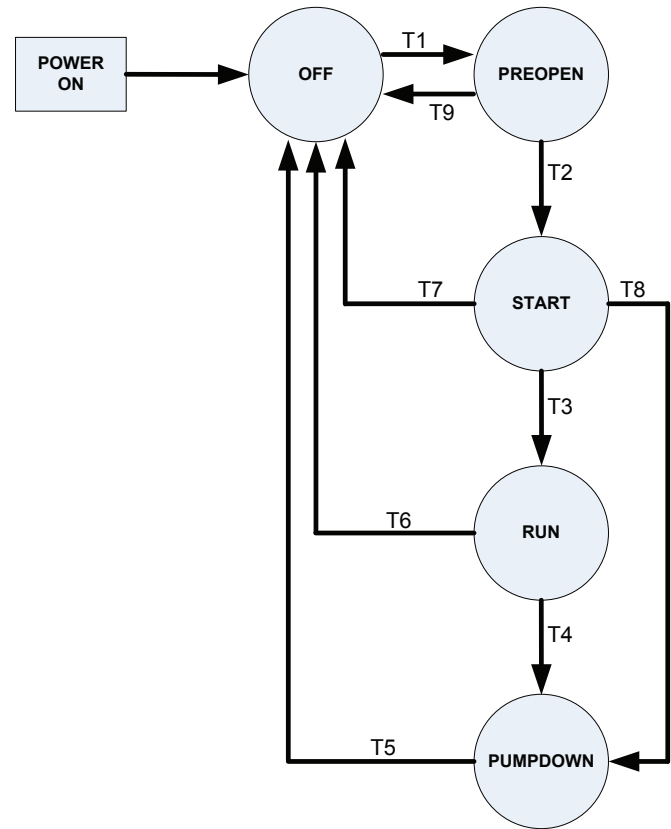

T1 – Off to Preopen - All of the following are required:

- Circuit is available to start per the previous section
- Adequate pressure in the evaporator and condenser (see No Pressure At Start Alarm)
- Unit capacity control logic requires the circuit to start

T2 – Preopen to Start

Evaporator EXV completes preopen operation.

T3 – Start to Run

Compressor speed ≥ 19 Hz for at least 30 seconds

T4 – Run to Pumpdown - Any of the following are required:

- Unit capacity control logic requires this circuit to stop
- Unit state is pumpdown
- A pumpdown alarm occurs on the circuit
- Circuit switch input is off
- Control Source = Network and BAS Circuit Mode = Off

T5 – Pumpdown to Off - Any of the following are required:

- Evaporator Pressure drops below Pumpdown Target Value
- Circuit state has been pump down for longer than the Pumpdown Time Limit set point
- Unit state is Off
- Rapid stop alarm occurs on the circuit

T6 – Run to Off - Any of the following are required:

- Unit state is Off
- Rapid stop alarm occurs on the circuit

T7 – Start to Off - Any of the following are required:

- Unit state is Off
- Rapid stop alarm occurs on the circuit

T8 – Start to Pumpdown - Any of the following are required:

- Unit capacity control logic requires this circuit to stop
- Unit state is pumpdown
- A pumpdown alarm occurs on the circuit
- Circuit switch is open
- Control Source = Network and BAS Circuit Mode = Off

T9 – Preopen to Off - Any of the following are required:

- Unit state is Off
- A rapid stop alarm occurs on the circuit
- A pumpdown alarm occurs on the circuit
- Circuit switch input is off
- Control Source = Network and BAS Circuit Mode = Off

Circuit Status

Circuit Status is displayed to indicate the general condition of the circuit. The following table lists the text displayed for each circuit status and the conditions that enable each status. If more than one status is enabled at the same time, the highest numbered status overrides the others and is displayed.

Table 54: Circuit Status

Enum	Status	Conditions
1	Off:Ready	Circuit ready to start if needed
2	Off:Cycle Timer	Circuit is off & cannot start due to active cycle timer
3	Off:OAT Low	Circuit is off & cannot start due to low ambient lockout
4	Off: Max Starts Per Hr	Circuit is off & cannot start due to exceeding 4 starts/hr
5	Off:BAS Disable	Circuit is off & cannot start due to BAS Circuit Mode input being set to Off
6	Off:Keypad Disable	Circuit is off & cannot start due to Circuit Mode set point on HMI is set to Disable
7	Off:Circuit Switch	Circuit is off & circuit switch is off
8	Off:Oil Heating	Circuit is off & Oil Sump Check = Not Ready
9	Off:Cmp VFD Heating	Circuit is off, compressor type is 3120 or 3122, and VFD Temp is too low to start.
10	Off:Alarm	Circuit is off & cannot start due to active circuit alarm
11	Off:Test Mode	Circuit is in test mode
12	EXV Preopen	Circuit is in preopen state

Enum	Status	Conditions
13	Run:Pumpdown	Circuit is in pumpdown state
14	Run:Normal	Circuit in run state & running normally
15	Run:Evap Press Low	Circuit in start or run state & cannot load due to low evap pressure
16	Run:Cond Press High	Circuit is in start or run state & cannot load due to high condenser pressure
17	Run:VFD Inp Current High	Circuit in start or run state & cannot load due to high VFD line current
18	Run:VFD Temp High	Circuit in start or run state & cannot load due to high VFD temp
19	Run:VFD Out Current High	Circuit in start or run state & cannot load due to high motor current
20	Run: VFD Cap Current Hi	Circuit is in start or run state and cannot load due to high VFD capacitor current.
21	Run:High LWT Limit	Circuit is in start or run state & cannot load due to the evaporator LWT exceeding the limit for allowing full capacity

Compressor Control

The compressor is controlled via:

- a digital output to give the run command to compressor VFD
- a modbus speed command to control compressor speed
- a Modbus command to reset alarms/faults in the compressor VFD
- digital outputs for compressor VR solenoids to control VR
- a digital output for liquid injection to the compressor
- a Modbus run command to the compressor VFD (for 3120 and 3122 compressors only)
- a digital output for the VFD heater (for 3120 and 3122 compressors only)
- a digital output for the oil sump heater (for 3120 and 3122 compressors only)

Run Command Output

The compressor run command output should be on when the circuit state is Start, Run, or Pumpdown. It should be off when the circuit state is Off or Preopen. For 3120 and 3122 compressors, the run command to the VFD via Modbus should also be on when the digital output is on.

VFD Alarm Reset Command

For all compressor types, when alarms are cleared in the unit controller and there are any active alarms or faults in the VFD, the alarm reset command should be sent to the VFD via modbus.

In addition, if the compressor type is 3120 or 3122, five seconds after the controller boots up if there are any active alarms in the VFD at all, the alarm reset command should be sent to the VFD. This is done to clear out any alarm in the VFD that might occur during a power cycle.

Cycle Timers

A minimum time must pass between starts of each compressor. When the compressor starts, a timer starts which will run for a time determined by the Start-Start Timer set point.

A minimum time must pass between the stop and start of each compressor. When the compressor stops, a timer starts which will run for a time determined by the Stop-Start Timer set point.

While either timer is running, the compressor cannot start. Both cycle timers will be enforced even through cycling of power to the chiller. These timers may be cleared via the Clear Cycle Timers set point.

Starts Per Hour Limit

In addition to the cycle timers, a limit of four starts per hour is enforced. A buffer of start times for the last four starts is maintained. If the current time is an hour or less after the first timestamp in the buffer, the next start will be delayed.

This limit is cleared if the Clear Cycle Timers set point is set to Yes.

Capacity Control

The compressor will vary capacity via changes to the motor speed (frequency).

Auto Capacity Control

The normal speed change is 1 Hz for all compressor configurations.

Circuit State = Off - Speed command is 0 Hz.

Circuit State = Preopen - Speed command is set to the minimum for the configuration.

Circuit State = Start - Immediately after starting, the compressor speed will be set to the minimum for the configuration and held there while circuit state is Start.

Circuit State = Run - After the circuit enters the Run state, changes to the speed are performed based on load and unload commands coming from the unit capacity control logic (see Unit Capacity Control section). The speed is constrained to a range from the minimum based on the configuration up to the Compressor Maximum Speed set point.

When a capacity increase occurs, a time delay starts; and when a capacity decrease occurs, a separate time delay starts. While either of these delays is active, no normal capacity

changes will occur. The load and unload delay times are calculated values.

Circuit State = Pumpdown - Speed command will drop 2 Hz every second until reaching the minimum for the configuration.

Manual Speed Control

The speed of the compressor may be controlled manually. Manual speed control is enabled via a set point with choices of Auto or Manual. Another set point allows setting the compressor speed. However, the resulting compressor speed is still limited to the range from the minimum speed based on configuration up to the Compressor Maximum Speed set point.

The compressor speed will be stepped up or down until it is equal to the speed that corresponds to the manual speed set point. Changes to the speed will be made as fast as allowed by the calculated load and unload delays. Speed control may be set to Manual only when circuit state is Start or Run.

Capacity control shall revert back to automatic control if either:

- circuit state changes from Start or Run to another state
- speed control has been set to Manual for four hours
- an unload event occurs on the circuit

Load and Unload Delay

LWT Error determines the delays for load and unload commands.

Table 55: Load and Unload Delay Conditions

LWT Error	Delay
LWT Error > Startup Delta T set point	Load command delay is 5 seconds
$0.1^{\circ}\text{C} \leq \text{LWT Error} \leq \text{Startup Delta T set point}$	Load command delay will vary from 5 seconds to 10 seconds
$-(\text{Stage Down Delta T set point}) \leq \text{LWT Error} \leq -0.1^{\circ}\text{C}$	Unload command delay will vary from 3 seconds to 6 seconds
LWT Error < $-(\text{Stage Down Delta T set point})$	Unload command delay is 3 seconds

VR Solenoid Valve Control

There are three solenoid valves for changing volume ratio of the compressor:

- 50 VR solenoid valve
- 75 VR solenoid valve
- 100 VR solenoid valve

The compressor should start with all three solenoid valves off. After compressor has been running for at least 20 seconds, the control logic will “stage” the solenoid valves. Table 56 shows which VR solenoid valves are on at each stage as well as stage up and stage down conditions. These staging conditions must be active for 30 seconds to trigger each stage up or down.

Table 56: VR Solenoid Valve Control Stages

Stage	VR	50 VR SV	75 VR SV	100 VR SV	Stage Up Condition	Stage Down Condition
0	1.6	Off	Off	Off	Pressure Ratio > 2.10	n/a
1	1.8	On	Off	Off	Pressure Ratio > 2.85	Pressure Ratio < 1.90
2	2.4	Off	On	Off	Pressure Ratio > 3.85	Pressure Ratio < 2.65
3	3.1	On	On	On	n/a	Pressure Ratio < 3.65

When the circuit state becomes Pumpdown or Off, all VR solenoids should be turned off.

Condenser Fan Control

Condenser fan control will vary in operation based on the Fan VFD Configuration set point.

Table 57: Condenser Fan Control Configurations

Fan VFD Configuration	Control Type	Control Mechanism
None	Staging only	Contactors
1st Fan VFD	Staging and speed control of 1st fan on the circuit	Contactors and VFD
All Fan VFD	Staging and speed control of all fans	ECM/DC permanent magnet motors on each fan

Physical Fan Layout

Fans are numbered as shown below (top view of chiller). Fan numbers start on the left side of the circuit, closest to the control box when facing the control box.

Circuit #1 fans start at 101 and can run through 116 depending on the number of fans on the circuit. Circuit #2 fans start at 201 and can run through 214 depending on the number of fans on the circuit.

Figure 80: Fan Numbering Diagram - Representative

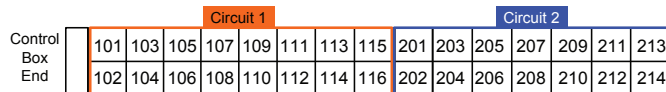

NOTE: Number of fans vary by unit configuration

Condenser Fan Control State

There are only two control states: Off and Condensing Temperature Control.

When the circuit state is Off or Preopen, condenser fan control will be in the Off state. All fans will be off.

When circuit state is Start, Run, or Pumpdown, the condenser fan control will be in the Condensing Temperature Control state. Fan staging and speed will be controlled as needed to drive the saturated condenser temperature to the target.

Saturated Condenser Temp Target

There are two purposes to have a variable condenser saturated temperature target:

- Maintain pressure difference and pressure ratio above low limit for compressor to run within operational envelope
- Achieve best performance at various conditions

The target value is displayed on the controller screen and is equal to the base target, but also constrained to a calculated range defined by the Minimum Target value and Maximum Target value.

Base Target

$$\text{Base Target (}^\circ\text{C)} = 0.979264 \times \text{OAT} + 10.7$$

Target Values

Minimum Target value is designed to keep the compressor in its operational envelope. This value is calculated by the controller based on the pressure difference, pressure ratio and fan stage down deadband.

First 10 minutes after compressor start, the minimum target is 38°C (100.4°F).

After the first 10 minutes, the minimum target range is gradually decreased to the calculated value at a rate of 0.1°C/sec.

If the chiller is configured with the WSE option and is operating in the Hybrid Cooling Pulldown or Hybrid Cooling Modulation, reductions in the target value should only be allowed at a limited rate. The rate of change allowed for target reductions should be 0.1°C every 30 seconds.

Fan Control – No VFD or 1st Fan VFD

Fans On Each Digital Output

The tables below show which fan numbers are on each of the fan digital outputs.

Table 58: Fan Numbers for Each Fan Digital Output

Circuit 1								
# Fans	4	6	8	10	12	14	16	
Fan Output #	1	-	101	101	101	101	101	101
	2	-	102	102	102	102	102	102
	3	-	103	103	103,105	103,105	103,105	103,105
	4	-	104,106	104	104,106	104,106	104,106	104,106,107,108
	5	-	105	105,107	107,109	107,109,111	107,109,111,113	109,111,113,115
	6	-	-	106,108	108,110	108,110,112	108,110,112,114	110,112,114,116

Circuit 2								
# Fans	4	6	8	10	12	14	16	
Fan Output #	1	201	201	201	201	201	201	-
	2	202	202	202	202	202	202	-
	3	203	203	203	203,205	203,205	203,205	-
	4	204	204,206	204	204,206	204,206	204,206	-
	5	-	205	105,107	207,209	207,209,211	207,209,211,213	-
	6	-	-	106,108	208,210	208,210,212	208,210,212,214	-

Fan Outputs Per Fan Stage

The table below shows which digital outputs are energized for each stage.

Table 59: Digital Outputs Energized for Each Stage

# Fans On Circuit	4	6	8	10	12	14	16	
Fan Stage	0	0	0	0	0	0	0	0
	1	1	1	1	1	1	1	1
	2	1,3	1,3	1,3	1,2	1,2	1,2	1,2
	3	1,2,3	1,3,5	1,5	1,3	1,3	1,3	1,3
	4	1,2,3,4	1,2,3,5	1,3,5	1,2,3	1,5	1,2,3	1,2,3
	5	-	1,3,4,5	1,2,3,5	1,3,5	1,2,5	1,5	1,5
	6	-	1,2,3,4,5	1,2,3,4,5	1,2,3,5	1,3,5	1,2,5	1,2,5
	7	-	-	1,2,3,5,6	1,3,4,5	1,2,3,5	1,3,5	1,3,5
	8	-	-	1,2,3,4,5,6	1,2,3,4,5	1,3,4,5	1,2,3,5	1,2,3,5
	9	-	-	-	1,3,4,5,6	1,2,3,4,5	1,3,4,5	1,4,5
	10	-	-	-	1,2,3,4,5,6	1,2,3,5,6	1,2,3,4,5	1,2,4,5
	11	-	-	-	-	1,3,4,5,6	1,3,5,6	1,3,4,5
	12	-	-	-	-	1,2,3,4,5,6	1,2,3,5,6	1,2,3,4,5
	13	-	-	-	-	-	1,3,4,5,6	1,4,5,6
	14	-	-	-	-	-	1,2,3,4,5,6	1,2,4,5,6
	15	-	-	-	-	-	-	1,3,4,5,6
16	-	-	-	-	-	-	1,2,3,4,5,6	

Staging Concept

As long as the condenser saturated temperature is within the band defined by the active stage up deadband and active stage down deadband, the fan stage will not change. When saturated condenser temperature is outside of the deadbands, error is accumulated and will cause a change in the fan stage.

Figure 81: Fan Staging Conditions

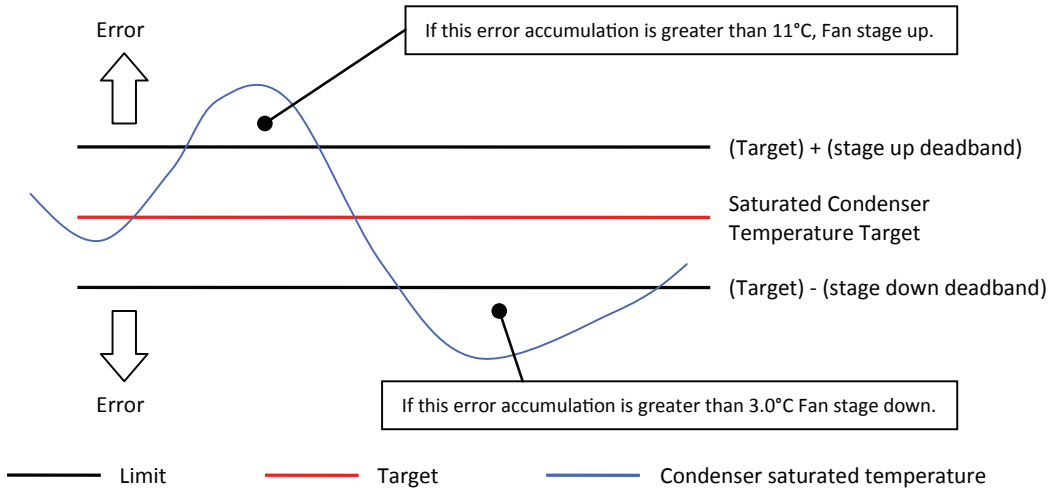

Staging Up

When the saturated condenser temperature is above the Target + the active deadband, a Stage Up error is accumulated.

$$\text{Stage Up Error Step} = \text{saturated condenser temperature} - (\text{target} + \text{Stage Up Deadband})$$

The Stage Up Error Step is added to Stage Up Accumulator once every five seconds, only if the saturated condenser temperature is not falling. When the Stage Up Error Accumulator is greater than 11°C (19.8°F) fan stage is increased by 1. When a stage up occurs or the saturated condenser temperature falls back within the Stage Up deadband the Stage Up Accumulator is reset to zero.

The first fan will turn on when condenser saturated temperature is above the target rather than using the error accumulator.

Staging Down

When the saturated condenser refrigerant temperature is below the Target – the active deadband, a Stage Down error is accumulated.

$$\text{Stage Down Error Step} = (\text{target} - \text{Stage Down deadband}) - \text{saturated condenser temperature}$$

The Stage Down Error Step is added to Stage Down Accumulator once every 5 seconds. When the Stage Down Error Accumulator is greater than 3°C (5.4°F), a fan stage is removed.

When a stage down occurs or the saturated condenser temperature rises back within the Stage Down deadband the Stage Down Error Accumulator is reset to zero.

Active Deadbands

Stage Up and Stage Down deadbands are determined by set points as shown in the following table:

Table 60: Stage Deadbands

Fan stage	Stage Up Setting	Stage Down Setting
0	Fan Stage Up Deadband 0	---
1	Fan Stage Up Deadband 1	Fan Stage Down Deadband 1
2	Fan Stage Up Deadband 2	Fan Stage Down Deadband 2
3	Fan Stage Up Deadband 3	Fan Stage Down Deadband 3
4	Fan Stage Up Deadband 4	Fan Stage Down Deadband 4
5 to 16	Fan Stage Up Deadband 5	Fan Stage Down Deadband 5

VFD on 1st Fan of Each Circuit

As an option, the first fan may be driven by a VFD. The VFD control will vary the fan speed to drive the saturated condenser temperature to a target value. The target value is normally the same as the saturated condenser temperature target.

VFD Speed Control

The VFD speed should always be 0% when the fan stage is 0. When the fan stage is greater than 0, the VFD speed will be calculated to control the saturated condenser temperature to the VFD target. The minimum and maximum speed are set by the VFD Min Speed and VFD Max Speed set points.

Stage Up Compensation

In order to create a smoother transition when the fan stage increases, the VFD compensates by slowing down initially. This is accomplished by adding the new fan stage up deadband to the VFD target. The higher target causes the VFD logic to decrease fan speed. Then, every 2 seconds, 0.1°C (0.18°F) is subtracted from the VFD target until it is equal to the saturated condenser temperature target set point.

Speed Signal to VFD

The fan VFD is controlled using a 0-10 volt signal. When the fan should be off, the signal will be 0 Vdc. When the fan should be running, the signal will vary based on the percent speed calculation.

$$\text{Speed Signal} = \text{Percent Speed} / 10$$

Fan Control In Waterside Econ State

Fan control when the cooling state is Waterside Econ includes fan staging and fan VFD control. The general concept is to stage fans to control WSE capacity and trim the capacity with the fan VFD speeds. During Waterside Econ state, if a circuit is disabled then it should not run the fans for WSE.

During Waterside Econ mode operation, the unit will change to control the chilled fluid set point based on the evaporator entering fluid sensor rather than the leaving sensor. Since the evaporator is not producing any cooling effect in this mode, the evaporator entering fluid temperature sensor is representative of the leaving fluid temperature the system will see.

If transition from Hybrid Cooling to Waterside Econ occurs, it is ok for fans to start staging on during pumpdown of running circuit(s).

Fan Control In Hybrid Cooling Modulation State

Fans on a circuit with a running compressor should operate the same as they normally do in Mechanical Cooling Only (based on condenser pressure control). If the compressor is not running, fans should be staged on as requested per the unit level capacity control logic.

During either Hybrid Cooling State, the condenser target should be calculated as it normally would but reductions in the value should be done at a controlled rate. Every 30 seconds the target should be allowed to drop by 0.1°C. Increases to the condenser target value will happen as often as the target calculation requires. These requirements ensure the running compressor is given a chance to unload in compensation for adding WSE capacity.

Fan Control - All Fans with VFD

If Fan VFD Configuration is set to All Fan VFD, different control logic will be used. All fan motors are ECM/DC fan motors which have integrated inverters and are controlled via modbus. This configuration requires the DC Fan Controller.

System Architecture

Architecture of the control system components involved in control of the ECM/DC fan motors is shown below. Data flows in both directions on the communication link as well as the Modbus connection.

Figure 82: Controller Communication Architecture

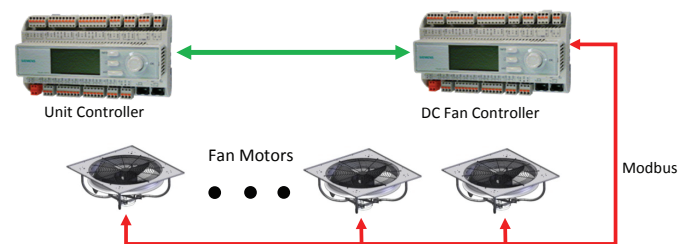

The following control logic will reside in the DC Fan Controller:

- Automatic control
- Alarm handling per individual fan motor
- Fan motor addressing process
- Fan motor testing control

Normal Control

When Control Mode is set to Auto, the logic in this section will automatically control the ECM/DC fan motors for normal chiller operation.

The VFD speed should always be 0% when the fan stage is 0. When the fan stage is greater than 0, the VFD speed will be calculated to control the saturated condenser temperature to the VFD target.

Speed Command To Motors

All fan motors will be sent a speed command via modbus. The speed command is in units of rpm with 800 rpm corresponding to 100% and will vary based on the percent speed calculation.

$$\text{Speed Command} = \text{Percent Speed Calculation} \times 8$$

Normally the same speed command is sent to all motors on a circuit.

Staging

Calculated RPM is a value used in the fan staging logic.

When the circuit run flag is 0, the fan stage is always 0. Once the fan stage is more than 0, it will not be allowed to drop back to 0 until the circuit run flag is 0.

The maximum fan stage is equal to the number of fans on the circuit. When fan stage is 0, it will be set to the maximum fan

stage when the PI (proportional integral) loop reaches 100%. This does not occur any time other than when the fan stage is 0.

Test Mode Control

When Control Mode is set to Test, the fan motors can be manually controlled for test purposes.

The test settings allow selecting values from 0% to 100%. When the test setting for a fan is set to 12.5% or higher, the speed command corresponding to the test setting will be sent and the run command will be sent to the fan.

$$\text{Speed Command} = \text{Test setting} \times 8$$

When Control Mode is no longer set to Test, the following actions should occur:

- all the test settings set back to 0%
- stop command sent to all motors
- speed command of 0 rpm sent to all motors

Evaporator EXV Control

This section outlines the positioning logic for the Evaporator EXV, which is the EXV installed in the liquid line feeding the evaporator.

- EXV will initially be positioned to control evaporator pressure
- EXV will normally be positioned to control SSH (suction superheat)
- SSH target will vary based on DSH (discharge superheat)
- In some conditions, EXV will be positioned to control evaporator pressure to keep all parameters within operating envelope

There are five EXV control states:

- Closed – EXV is closing or in the closed position
- Preopen – EXV is opening prior to compressor start
- Start Pressure Control – EXV is controlling to pressure target after compressor start
- SSH Control – EXV is controlling suction superheat
- MOP Control – EXV is controlling to maximum operating pressure for compressor

Closed State

If the unit is configured without liquid line solenoid valves, the EXV position should be 0% any time the EXV is in a closed state. The 0% position command also causes the evaporator EXV module driver to re-initialize the valve to the zero position.

If the unit is configured with liquid line solenoid valves, the EXV position should be 0% when the EXV initially enters the closed state, while it is re-initializing to the zero position. After the EXV position command has been 0% for one minute, the EXV should be moved to 5% to prevent excessive pressure buildup between the EXV and liquid line solenoid valve.

Preopen Operation

When the EXV state is Preopen, the EXV position command will be 30%.

Pressure Control State

In Start Pressure Control, the EXV is positioned to control the evaporator pressure to a target.

Pressure Target

The pressure target is calculated based on evaporator LWT, then limits are applied to keep the target in an acceptable range.

The base target value varies from 65 kPa to 420 kPa as LWT varies from -5°C to 30°C.

Figure 83: Evaporator EXV Pressure Target

R-134A

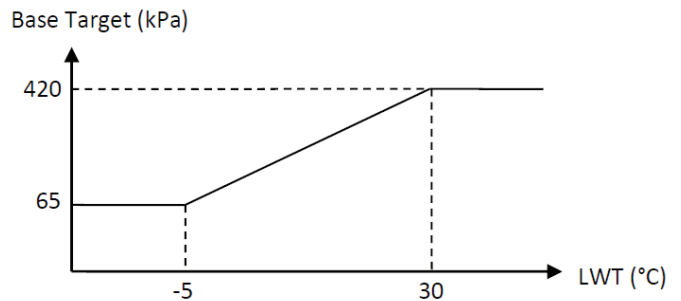

R-513A

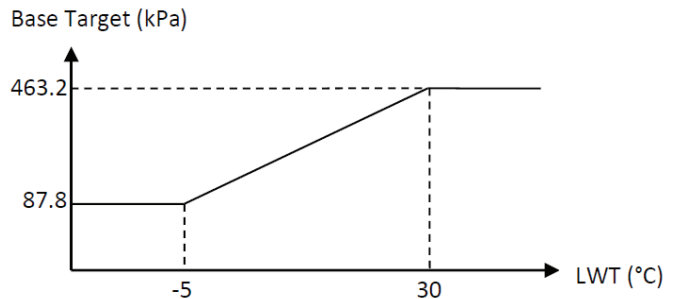

This base target is then limited to a range as defined by the Minimum Limit and Maximum Limit shown below:

- Minimum Limit = Low Pressure Hold set point + 25 kPa
- Maximum Limit = Min {(Cond Pr + 101.325) / 1.7 – 101.325, Cond Pr – 180}
- If Maximum Limit < Minimum Limit, then Pressure Target = Minimum Limit

MOP Control State

In MOP (Maximum Operating Pressure) Control, the EXV is positioned to control the evaporator pressure to a target.

MOP Target

The MOP Target is $\text{Min} \{450, (\text{Cond Pr} + 101.325) / 1.7 - 101.325, \text{Cond Pr} - 180\}$.

Superheat Control State

In superheat control, the EXV is positioned to control suction superheat (SSH) to the SSH Target.

SSH Target

The SSH target varies linearly based on discharge superheat (DSH). This target is updated every 10 seconds and averaged over a 100 second period (with sampling every 10 seconds).

Figure 84: Evaporator EXV Suction Superheat Target

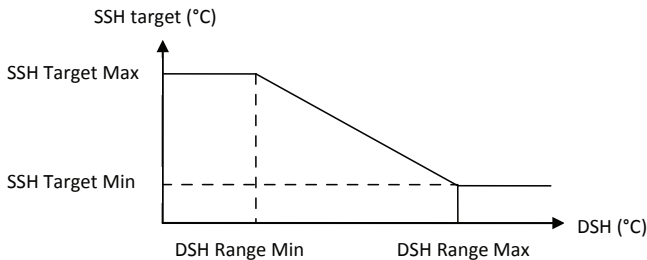

When the EXV transitions to the superheat control state, the target will initially be set to the SSH value. The target will then ramp up or down until it meets the calculated SSH target.

Limits for the SSH target are:

- If $\text{SSH Target Min} \leq \text{current SSH} \leq \text{SSH Target Max}$, the target will start at the current SSH value and increase or decrease by 0.1°C every 10 seconds until it meets calculated SSH target.
- If $\text{current SSH} > \text{SSH Target Max}$, the target value will start ramping from SSH Target Max. Then the target will decrease by 0.1°C every 10 seconds until it meets calculated SSH target.
- If $\text{current SSH} < \text{SSH Target Min}$, the target value will start ramping from SSH Target Min. Then the target will increase by 0.1°C every 10 seconds until it meets calculated SSH target.

Economizer EXV Control

The economizer circuit is controlled using an EXV and depending on configuration, various solenoid valves. This is an optional feature that will only be enabled if the Economizer Configuration set point is set to either “Twin” or “2 Single”. If the configuration set point is set to “None”, then the economizer position should remain 0% and the economizer solenoid valve outputs should remain off.

Control Concept

- Maintain DSH above requirements for compressor
- Maximize circuit performance at the operating conditions
- Minimize vibration in economizer circuit piping

Economizer EXV Configuration

There are 3 available economizer configurations. The option to be used by the unit depends on the hardware installed in the unit. The three options for this setting are:

- None – Economizer package not installed onto unit, or not in use.
- Twin – Carel Twin EVD drive is in use. This drive controls the economizer EXV in both circuits. Economizer EXV Communication Failure alarm is a unit alarm in this case.
- 2 Single – Two separate Carel EVD drivers are in use. Each controller has a circuit specifically assigned to it and controls the function of the economizer EXV. Economizer EXV Communication Failure alarm is a circuit alarm in this configuration.

Economizer EXV States

There are three economizer EXV states:

- Closed: EXV is closing or closed
- Purge: EXV is opening to release condensed liquid in a controlled manner
- Superheat: EXV is controlling economizer gas superheat

Figure 85: Economizer EXV States

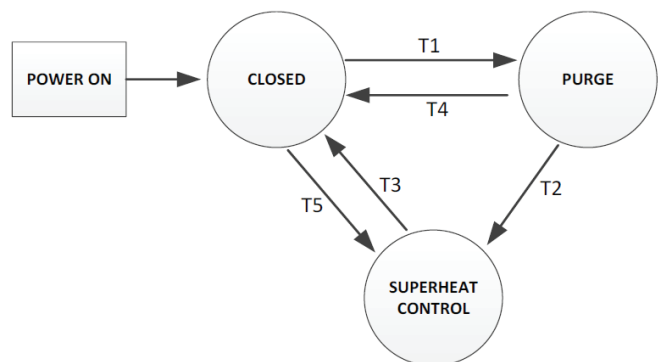

T1 – Closed to Purge

This transition can occur only if the configuration is as follows:

- Refrigerant Economizer setting = Yes
- Economizer Piping setting = Copper
- Economizer Check Valves setting = No
- Compressor Type setting = F3ALVVR60, F3ALVVR86, F3BLVVR86, or F4ALVVR80

In addition, all of the following conditions must be true:

- Circuit state is Run for more than 3 minutes
- Pressure difference > 700kPa for 1 minute
- OAT > 5°C for 1 minute
- Compressor current < High Motor Current Hold reset value for 1 minute
- Condenser saturated temperature < High Pressure Hold reset value for 1minute
- Economizer pressure sensor fault is not active
- Economizer temperature sensor fault is not active
- Economizer EXV motor fault is not active
- Economizer EXV driver communication fault is not active
- Either:
 - Compressor speed > 32 Hz for 3 minutes
 - Saturated Condenser Temperature < 0.8 x Saturated Evaporator Temperature + 15 + compressor speed for 3 minutes
- Circuit capacity ≥ 70%
- Discharge superheat > 5.56°C

T2 – Purge to Superheat Control

All of the following conditions must be true:

- EXV state has been Purge for 38 seconds
- DSH > Low DSH Limit set point

T3 – Superheat Control to Closed

Any of the following conditions will trigger this transition:

- Circuit state is not Run
- Economizer pressure sensor fault alarm is active
- Economizer temperature sensor fault alarm is active
- Economizer EXV motor alarm is active
- Economizer EXV driver communication fault alarm is active
- Pressure difference < 650 kPa for 1 minute
- Both of these conditions are true for at least 3 minutes:
 - Compressor Speed < 30Hz
 - Saturated Condenser Temperature > 0.8 x Saturated Evaporator Temperature + 18 + compressor speed
- Circuit capacity ≤ 50%
- Discharge superheat < Low DSH Limit set point

T4 – Purge to Closed

Any of the following conditions will trigger this transition:

- Circuit state is not Run
- Economizer pressure sensor fault alarm is active
- Economizer temperature sensor fault alarm is active
- Economizer EXV motor alarm is active
- Economizer EXV driver communication fault alarm is active

T5 – Closed to Superheat Control

This transition can occur only if the configuration is as follows:

- Refrigerant Economizer setting = Yes
- Economizer Piping setting = Steel
 - OR Economizer Check Valves setting = Yes
 - OR Compressor Type setting = 3120 or 3122

In addition, all of the following conditions must be true:

- Circuit state is Run for more than 3 minutes
- Pressure difference > 700kPa for 1 minute
- OAT > 5°C for 1 minute
- Compressor current < High Motor Current Hold reset value for 1 minute
- Condenser saturated temperature < High Pressure Hold reset value for 1minute
- Economizer pressure sensor fault is not active
- Economizer temperature sensor fault is not active
- Economizer EXV motor fault is not active
- Economizer EXV driver communication fault is not active
- Either:
 - Compressor speed > 32Hz for 3minutes
 - Saturated Condenser Temperature < 0.8 x Saturated Evaporator Temperature + 15 + compressor speed for 3minutes
- Circuit capacity ≥ 70%
- Discharge superheat > 5.56°C

Economizer Solenoid Valve Control

Some AWW models come equipped with refrigerant economizer check valves. The configuration of the chiller will determine what solenoid valves will need to be controlled in relation to the economizer. The economizer check valves require balancing suction and discharge pressure to each side of the valve to properly seat them. The pressures are regulated by solenoid valves and hoses connected to specific schrader valves located on the copper lines and the compressor. The digital outputs from the solenoid valves are located on the Economizer Solenoid Control module (ESC).

Economizer Activation Solenoid Valve

The economizer solenoid valve output should be on when either the Economizer state is Purge for at least 8 seconds or the Economizer state is Superheat Control. The economizer solenoid valve output should be off when the Economizer state is Closed.

NOTE: The economizer solenoid valve must wait 8 seconds after entering the Purge state to open because the economizer EXV will need to close before the solenoid valve is opened. The 8 second wait allows enough time for that to happen.

Economizer Suction and Discharge Solenoid Valves

When equipped with economizer check valves, solenoid valves will be used to expose certain areas of the economizer circuit to either suction or discharge pressure in order to assist in closing the check valve and keeping it closed when the circuit is running but the economizer is not on.

The economizer discharge SV output should be activated when all of the following conditions are true:

- Circuit state is preopen, start, or run
- Economizer state is off for >10s
- Economizer pressure \geq Evaporator pressure x 1.3

The economizer discharge SV output should be deactivated when any of the following conditions are true:

- Economizer pressure \leq Evaporator pressure x 1.1
- Circuit state is off or pumpdown
- Economizer state is superheat

The economizer suction SV output should be activated when the discharge SV output is activated.

The economizer suction SV output should be deactivated when any of the following conditions are true:

- Economizer Discharge SV output has been deactivated for time \geq 10s
- Circuit state is off or pumpdown
- Economizer state is superheat

Liquid Injection Solenoid Valve

As an option, the chiller can be equipped with liquid injection on the compressors. When configured with this option, the Liquid Injection Configuration setting should be set to Yes and the liquid injection solenoid valve outputs can be activated.

Liquid injection solenoid valve output is activated if both of the following are true:

- Circuit state is Run
- Discharge Temperature > Liquid Injection Activation set point

Liquid injection solenoid valve output will be turned off if either of the following are true:

- Discharge Temperature < Liquid Injection Activation set point - 15°C
- Circuit state is no longer Run

Liquid Line Solenoid Valve

As an option, the chiller can be equipped with liquid line solenoid valves. When configured with this option, the Liquid Line Solenoid Valve Configuration setting should be set to Yes.

If the chiller is configured with liquid line solenoid valves, the liquid line solenoid valve output should be activated when the circuit enters the Preopen state and remain on during the Start and Run states. The output should be turned off 10 seconds after the circuit enters the Pumpdown state or when the circuit state is Off.

Circuit Capacity Overrides

The following conditions override automatic capacity control as described. These overrides keep the circuit from entering a condition in which it is not designed to run.

High Water Temperature Capacity Limit

If the evaporator LWT is 25°C (77°F) or higher, the circuit capacity will be limited. If circuit capacity resulting from the next compressor speed increase is 81.5% or more, the circuit cannot increase in capacity.

If the circuit capacity is higher than 81.5%, the circuit will reduce capacity until it is at 81.5% or lower.

Once this limit is triggered, it will be in effect until evaporator LWT is less than 25°C (77°F) for at least one minute.

Alarms and Events

Situations may arise that require some action from the chiller, or that should be logged for future reference. The alarm digital output will be operated based on active alarm scenarios as shown in the table below.

State	Scenario
Off	No alarms preventing the chiller or an individual circuit from running
Blinking	One, and only one, circuit has an alarm preventing it from running
On	Unit alarm preventing chiller from running or both circuits have alarms preventing them from running

For the Blinking state, the output should cycle five seconds on then five seconds off while the indicated scenario is active.

Alarm Logging

All alarms appear in the active alarm list while active. All alarms are added to the alarm log when triggered and when cleared. Entries in the log representing the occurrence of an alarm will be preceded by '+' while entries representing the clearing of an alarm will be preceded by '-'.

When an alarm occurs, the alarm type, date, and time are stored in the active alarm buffer corresponding to that alarm (viewed on the Alarm Active screens), and also in the alarm history buffer (viewed on the Alarm Log screens). The active alarm buffers hold a record of all current alarms.

The alarm log can be exported to a formatted SD card in the controller. A setting called "Log Export to SD" will be used to initiate this when set to Yes. The exported log will be saved in a text file on the SD card with each line representing an entry in the log. Only what is in the actual alarm log will be saved to the file when the export was initiated.

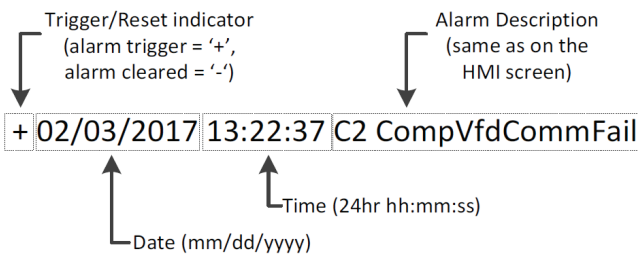

Signaling Alarms

The following actions will signal that an alarm has occurred:

- The unit or circuit executes a rapid or pumpdown shutoff.
- An alarm bell icon will be displayed in the upper right-hand corner of all controller screens, including the optional remote user interface panel's screens.
- An optional field supplied and wired remote alarm device will be activated.

Clearing Alarms/Faults

Active alarms can be cleared through the keypad/display or a BAS network. Alarms are automatically cleared when controller power is cycled. Alarms are cleared only if the conditions required to initiate the alarm no longer exist. All alarms and groups of alarms can be cleared via the keypad or network via LON using nviClearAlarms and via BACnet using the ClearAlarms object.

To use the keypad, follow the Alarm links to the Alarms screen, which will show Active Alarms and Alarm Log. Select Active Alarm and press the wheel to view the Alarm List (list of current active alarms). They are in order with the most recent on top. The second line on the screen shows Alm Cnt (number of alarms currently active) and the status of the alarm clear function. An active password is not necessary to clear alarms.

If the problem(s) causing the alarm have been corrected, the alarms will be cleared, disappear from the Active Alarm list and be posted in the Alarm Log. If not corrected, the On will immediately change back to OFF and the unit will remain in the alarm condition.

Description of Alarms

Details for each alarm are listed in a table format as shown below. The table below explains each row in the tables.

Alarm:	Description of the alarm
Displayed Text:	Text displayed on HMI in the alarm lists
Trigger:	Conditions required to trigger the alarm
Action Taken:	Actions that should be taken when the alarm triggers
Reset:	Method by which the alarm can be cleared and conditions required for doing so, if any

Unit Alarms

Unit GFP Fault

Alarm:	Unit GFP Fault
Displayed Text:	Unit Ground Fault
Trigger:	All of the following are true: Ground Fault Protection Option set point = Single Point GFP Relay 1 input is off for 1 second
Action Taken:	Rapid shutdown all circuits and lock out unit from running
Reset:	Auto reset when GFP Relay 1 input is on for 5 seconds

Circuit 1 GFP Fault

Alarm:	Circuit 1 GFP Fault
Displayed Text:	C1 Ground Fault
Trigger:	All of the following are true: <ul style="list-style-type: none"> • Ground Fault Protection Option set point = Multi Point • GFP Relay 1 input is off for 1 sec
Action Taken:	Rapid shutdown all circuits and lockout unit from running.
Reset:	Auto reset when GFP Relay 1 input is on for 5 seconds

Circuit 2 GFP Fault

Alarm:	Circuit 2 GFP Fault
Displayed Text:	C2 Ground Fault
Trigger:	All of the following are true: <ul style="list-style-type: none"> • Ground Fault Protection Option set point = Multi Point • GFP Relay 2 input is off for 1 sec
Action Taken:	Rapid shutdown all circuits and lockout unit from running.
Reset:	Auto reset when GFP Relay 2 input is on for 5 seconds

Evaporator Flow Loss

Alarm:	Evaporator Flow Loss
Displayed Text:	Evap Water Flow Loss
Trigger:	1: Evap Pump State = Run AND Evap Flow Digital Input = No Flow for time > Flow Proof set point AND at least one circuit is not in the Off state 2: Evap Pump State = Start for time greater than Recirculate Timeout set point and all pumps have been tried and Evap Flow Digital Input = No Flow
Action Taken:	Rapid shutdown all circuits and: <ul style="list-style-type: none"> • if an auto reset occurrence has triggered, keep unit enabled and allow the evaporator recirculation sequence to proceed • if a manual reset occurrence has been triggered, lock out unit from running

Reset:	<p>This alarm can be cleared at any time manually via the keypad or via the BAS clear alarm command.</p> <p>If active via trigger condition 1:</p> <p>When the alarm occurs due to this trigger, it can auto reset the first two times each day, with the third occurrence being manual reset. When the auto reset occurrences are triggered, the unit will remain enabled to run (rather than going to an off state).</p> <p>For the auto reset occurrences, the alarm will reset automatically when the evaporator state is Run again. This means the alarm stays active while the unit waits for flow, then it goes through the recirculation process after flow is detected. Once the recirculation is complete, the evaporator goes to the Run state which will clear the alarm. After three occurrences, the count of occurrences is reset and the cycle starts over if the manual reset flow loss alarm is cleared.</p> <p>If active via trigger condition 2:</p> <p>If the flow loss alarm has occurred due to this trigger, it is always a manual reset alarm.</p>
--------	---

Evaporator Water Freeze Protect

Alarm:	Evaporator Water Freeze Protect
Displayed Text:	Evap Water Freeze
Trigger:	Evaporator LWT or EWT equal to or less than Evaporator Freeze Protect set point for a time at least as long as the evaporator recirculation time. If the sensor fault is active for either LWT or EWT, then that sensor value cannot trigger the alarm.
Action Taken:	Rapid shutdown all circuits and lock out unit from running
Reset:	This alarm can be cleared manually via the keypad, but only if evaporator LWT and EWT are both above the Evaporator Freeze Protect set point or have a sensor fault (meaning the temperature reading is not valid).

Evaporator Water Temperatures Inverted

Alarm:	Evaporator Water Temperatures Inverted
Displayed Text:	EvapWaterTempInverted
Trigger:	All of the following are true for at least 60 seconds: <ul style="list-style-type: none"> • Evap EWT < Evap LWT – 1°C • at least one circuit is in Start or Run state • EWT sensor fault not active • LWT sensor fault not active
Action Taken:	Normal shutdown all circuits and lock out unit from running
Reset:	This alarm can be cleared manually via the keypad or via BAS command.

Evaporator LWT Sensor Fault

Alarm:	Evaporator LWT Sensor Fault
Displayed Text:	Evap LWT SenFault
Trigger:	If any of the following occur for more than one second: <ul style="list-style-type: none"> • Resistance value is < 340 Ω • Resistance value is > 300 kΩ • Reliability value reported for input is anything other than 'NoFault'
Action Taken:	Rapid shutdown all circuits and lock out unit from running
Reset:	This alarm can be cleared manually via the keypad or BAS command if the following are true for at least 5 seconds: <ul style="list-style-type: none"> • Resistance value is from 340 Ω to 300 kΩ • Reliability value reported for input is 'NoFault'

Evaporator EWT Sensor Fault

Alarm:	Evaporator EWT Sensor Fault
Displayed Text:	Evap EWT SenFault
Trigger:	If any of the following occur for more than one second: <ul style="list-style-type: none"> • Resistance value is < 340 Ω • Resistance value is > 300 kΩ • Reliability value reported for input is anything other than 'NoFault'
Action Taken:	Normal shutdown all circuits and lock out unit from running
Reset:	This alarm can be cleared manually via the keypad or BAS command if the following are true for at least 5 seconds: <ul style="list-style-type: none"> • Resistance value is from 340 Ω to 300 kΩ • Reliability value reported for input is 'NoFault'

OAT Sensor Fault

Alarm:	OAT Sensor Fault
Displayed Text:	OAT SenFault
Trigger:	If any of the following occur for more than one second: <ul style="list-style-type: none"> • Resistance value is < 340 Ω • Resistance value is > 300 kΩ • Reliability value reported for input is anything other than 'NoFault'
Action Taken:	Normal shutdown all circuits and lock out unit from running
Reset:	This alarm can be cleared manually via the keypad or BAS command if the following are true for at least five seconds: <ul style="list-style-type: none"> • Resistance value is from 340 Ω to 300 kΩ • Reliability value reported for input is 'NoFault'

External Alarm

Alarm:	External Alarm
Displayed Text:	External Alarm
Trigger:	External alarm input is open for at least 1 second.
Action Taken:	Rapid shutdown all circuits and lock out unit from running
Reset:	Auto clear when external alarm input is closed for five seconds.

Emergency Stop

Alarm:	Emergency Stop
Displayed Text:	Emergency Stop Switch
Trigger:	Emergency Stop input off for 1 second
Action Taken:	Rapid shutdown all circuits and lock out unit from running
Reset:	This alarm can be cleared manually via the keypad or via BAS command after the emergency switch input is on for 5 sec.

AC Module Comm Failure

Alarm:	AC Module Comm Failure
Displayed Text:	AC Module Comm Fail
Trigger:	Communication with the module has failed. Specifically, this means the reliability value reported for the module is anything other than 0 for at least 3 seconds.
Action Taken:	Rapid shutdown all circuits and lock out unit from running
Reset:	This alarm can be cleared manually via the keypad or BAS command after reliability value reported for the module is 0 for at least five seconds.

ESC Module Comm Failure

Alarm:	ESC Module Comm Failure
Displayed Text:	ESC Module Comm Fail
Trigger:	Economizer Check Valves set point = Yes and communication with the module has failed. Specifically, this means the reliability value reported for the module is anything other than 0 for at least 3 seconds
Action Taken:	Normal shutdown all circuits and lock out unit from running
Reset:	This alarm can be cleared manually via the controller HMI or BAS command after reliability value reported for the module is 0 for at least 5 seconds.

Evaporator EXV Module Comm Failure

Alarm:	Evaporator EXV Module Comm Failure
Displayed Text:	EvapExvModCommFail
Trigger:	When evaporator Expansion Valve Type is set as E6V model number (see Table 39), communication with the EVD module called EEXV1 has failed. Specifically, this means that 10 consecutive failures of read/write command blocks for this modbus address have occurred.
Action Taken:	Rapid shutdown all circuits and lock out unit from running
Reset:	This alarm can be cleared manually via the keypad or BAS command after communication is restored for at least 5 seconds.

DC Fan Controller Comm Failure

Alarm:	DC Fan Controller Comm Failure
Displayed Text:	DcFanCtrlCommFail
Trigger:	Condenser Fan VFD Configuration set point is set to All Fan VFD and heartbeat from DC fan controller is not received for 30 seconds.
Action Taken:	Normal shutdown all circuits and lock out unit from running
Reset:	This alarm can be cleared manually via the keypad or BAS command if heartbeat from DC fan controller has been received in the last 30 seconds.

Evaporator Pump #1 Failure

Alarm:	Evaporator Pump #1 Failure
Displayed Text:	Evap Pump 1 Fault
Trigger:	Unit is configured with primary and backup pumps, pump #1 is running, and the pump control logic switches to pump #2.
Action Taken:	Backup pump is used
Reset:	This alarm can be cleared manually via the keypad or BAS command.

Evaporator Pump #2 Failure

Alarm:	Evaporator Pump #2 Failure
Displayed Text:	Evap Pump 2 Fault
Trigger:	Unit is configured with primary and backup pumps, pump #2 is running, and the pump control logic switches to pump #1.
Action Taken:	Backup pump is used
Reset:	This alarm can be cleared manually via the keypad or BAS command.

Bad Demand Limit Input

Alarm:	Bad Demand Limit Input
Displayed Text:	Bad Demand Lim Input
Trigger:	Demand limit input out of range and Demand Limit set point is set to On. For this alarm, out of range is considered to be a signal less than 3 mA or more than 21 mA.
Action Taken:	Demand limit function and signal are ignored
Reset:	Auto clear when Demand Limit set point is set to Off or demand limit input back in range for 5 seconds.

Bad LWT Reset Input

Alarm:	Bad LWT Reset Input
Displayed Text:	Bad LWT Reset Input
Trigger:	LWT Reset Type set point is 4-20 mA and LWT reset input out of range. For this alarm out of range is considered to be a signal less than 3 mA or more than 21 mA.
Action Taken:	LWT reset signal and 4-20 mA function are ignored
Reset:	Auto clear when LWT Reset Type set point is not 4-20 mA or LWT reset input back in range for five seconds.

Economizer EXV Module Comm Failure

Alarm:	Economizer EXV Module Comm Failure Treat as Warning category if Econ Check Valves set point = No. Treat as Fault category if Econ Check Valves set point = Yes.
Displayed Text:	EconExvModCommFail
Trigger:	Econ Refrig = Twin, Economizers set point = Yes, and communication with the economizer EXV module has failed. This means that either a modbus configuration error has occurred, or at least 10 consecutive modbus commands failed to receive a valid response.
Action Taken:	Warning: Economizer is moved to closed state and valve command is set to 0% in control logic, though without communication the module is left to operate per logic embedded in it. It should be set up to automatically close the valves when communication is lost. Fault: Normal shutdown all circuits and lock out unit from running.
Reset:	This alarm can be cleared manually via the controller HMI or BAS command after communication is restored for at least 5 seconds.

RapidRestore Module Comm Failure

Alarm:	RapidRestore Module Comm Failure
Displayed Text:	RR Module Comm Fail
Trigger:	RapidRestore set point is set to 'Yes' and communication with the RapidRestore module has failed. This means the reliability value reported for the module is anything other than 0 for at least 3 seconds.
Action Taken:	RapidRestore functionality will be disabled while the module is not communicating since an input on the module is required in order to enable the functionality.
Reset:	This alarm will automatically clear after communication is restored for at least 5 seconds.

Waterside Economizer EWT Sensor Fault

Alarm:	Waterside Economizer EWT Sensor Fault
Displayed Text:	WSE EWT SenFault
Trigger:	If any of the following occur for more than one second: <ul style="list-style-type: none"> • Resistance value is < 340 Ω • Resistance value is > 300 kΩ • Reliability value reported for input is anything other than 'NoFault'
Action Taken:	Cannot use Waterside economizer
Reset:	This alarm can be cleared manually via the keypad or BAS command if the following are true for at least 5 seconds: <ul style="list-style-type: none"> • Resistance value is from 340 Ω to 300 kΩ • Reliability value reported for input is 'NoFault'

Waterside Economizer Valve Fault

Alarm:	Waterside Economizer Valve Fault
Displayed Text:	WSE Valve Fault
Trigger:	If the following conditions are true for 90 seconds the alarm should be triggered: <ul style="list-style-type: none"> • WSE water valve 1 command = 100% • WSE water valve 1 position < 90% Or, if the following conditions are true for 90 seconds the alarm should be triggered: <ul style="list-style-type: none"> • WSE water valve 2 command = 0% • WSE water valve 2 position > 10% In addition, if the valve position signals are out of range as follows the alarm should be triggered: <ul style="list-style-type: none"> • valve 1 signal is out of range on high side for one second • valve 2 signal is out of range on low side for one second
Action Taken:	Disable and lock out chiller from running
Reset:	This alarm can be cleared manually via the controller HMI or BAS command.

Waterside Economizer Valve Problem

Alarm:	Waterside Economizer Valve Problem
Displayed Text:	WSE Valve Problem
Trigger:	<p>If the following conditions are true for 90 seconds the alarm should be triggered:</p> <ul style="list-style-type: none"> • WSE water valve 2 command = 100% • WSE water valve 2 position < 90% <p>Or if the following conditions are true for 90 seconds the alarm should be triggered:</p> <ul style="list-style-type: none"> • WSE water valve 1 command = 0 • WSE water valve 1 position > 10% <p>In addition, if the valve position signals are out of range as follows the alarm should be triggered:</p> <ul style="list-style-type: none"> • valve 1 signal is out of range on low side for 1 second • valve 2 signal is out of range on high side for 1 second
Action Taken:	Waterside Economizer disabled
Reset:	This alarm can be cleared manually via the controller HMI or BAS command.

Circuit Alarms

Low Evaporator Pressure

Alarm:	Low Evaporator Pressure
Text:	Cn EvapPressLow
Trigger:	<p>When circuit state = Start and OAT ≥ -8°C, any of the following can trigger:</p> <ul style="list-style-type: none"> • Evap Pressure < 0 kPa for 5 seconds • Evap Pressure < -50 kPa for 2 seconds <p>When circuit state = Start and OAT < -8°C, any of the following can trigger:</p> <ul style="list-style-type: none"> • Evap Pressure < 0 kPa for 20 seconds • Evap Pressure < -50 kPa for 5 seconds <p>Note: for this condition where OAT is lower than -8°C, the first two times any of the trigger conditions are met in a day the circuit will only shut down and the alarm will not trigger. On the third occurrence in a day, the circuit will shut down and the alarm will be triggered.</p> <p>For first 5 minutes circuit state = Run, any of the following can trigger:</p> <ul style="list-style-type: none"> • Evap Pressure < 0 kPa for 5 seconds • Evap Pressure < -50 kPa for 2 seconds • Evap Pressure < Low Pressure Unload set point for 100 seconds <p>After circuit state = Run for 5 minutes, any of the following can trigger:</p> <ul style="list-style-type: none"> • Evap Pressure < 30 kPa for 5 seconds • Evap Pressure < -30 kPa for 2 seconds • Evap Pressure < Low Pressure Unload set point for time > Freeze Time <p>Where:</p> <ul style="list-style-type: none"> • Freeze Time = 70 – 0.906 x Freeze Error, limited to range of 20-70 seconds • Freeze Error = Low Evap Pressure Unload – Evap Pressure <p>For any trigger condition, the alarm cannot trigger if the evaporator pressure sensor fault is active.</p>
Action Taken:	Rapid shutdown of circuit and lock out from running
Reset:	This alarm can be cleared manually via the Unit Controller keypad.

Figure 86: Low Evaporator Pressure Fault Diagram

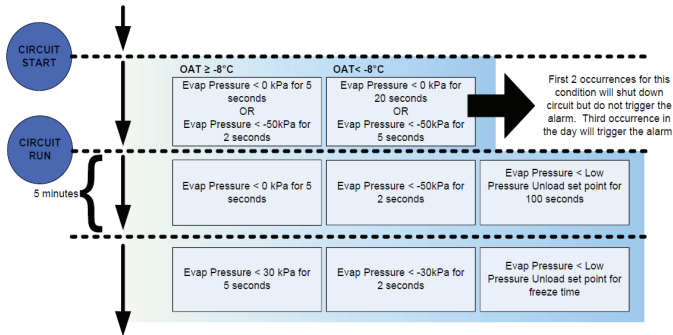

High Condenser Pressure

Alarm:	High Condenser Pressure
Displayed Text:	Cn CondPressHigh
Trigger:	Saturated Condenser Temp > Max Saturated Condenser Value for time longer than High Condenser Pressure Delay set point.
Action Taken:	Rapid shutdown of circuit and lock out from running
Reset:	This alarm can be cleared manually via the Unit Controller keypad if Saturated Condenser Temp < Max Saturated Condenser Value.

Low Pressure Difference Or Ratio

Alarm:	Low Pressure Difference Or Ratio
Displayed Text:	Cn LowPrDiffOrRatio
Trigger:	This alarm is triggered on the third occurrence of the below conditions within two hours. Prior occurrences are events.
Trigger 1:	Pressure ratio is < 1.6 for longer than the Low Pressure Diff/Ratio Delay set point after circuit state transition to Run. Pressure ratio is calculated as shown with pressures in kPa: <i>Ratio = (Cond Press + 101.325)/(Evap Press + 101.325)</i>
Trigger 2:	Pressure difference is less than 180 kPa for longer than the Low Press Diff/Ratio Delay set point after circuit state transition to Run. Press difference is calculated as shown in kPa: <i>Difference = (Cond Pressure) - (Evap Pressure)</i> Alarm/event cannot trigger for 5 minutes after circuit state transitions to Preopen if OAT < 7°C, however the trigger logic will still run during this window.
Action Taken:	Rapid shutdown of circuit and lock out from running
Reset:	This alarm should auto reset every time until it has triggered 3 times within 2 hours and be cleared manually via Unit Controller keypad or BAS.

Mechanical Low Pressure Switch

Alarm:	Mechanical Low Pressure Switch
Displayed Text:	Cn MLP Switch
Trigger:	The alarm is triggered if all of the following are true for at least 40 seconds: <ul style="list-style-type: none"> • Circuit State is Run • MLP Switch input is off <p>The alarm also requires Evaporator Configuration = Remote to trigger. This means if the Evaporator Configuration is set to Packaged then the MLP Switch inputs are ignored and the alarm is disabled.</p>
Action Taken:	Rapid shutdown of circuit and lock out from running.
Reset:	This alarm can be cleared manually via the controller HMI if the MLP Switch input is on.

Mechanical High Pressure Switch

Alarm:	Mechanical High Pressure Switch
Displayed Text:	Cn MHP Switch
Trigger:	With F3 and F4 compressor types: Compressor VFD reports Safe Disable Input alarm. This is the case when the alarm code reported by the VFD is either 003B or 003C (hex). With 3120 and 3122 compressor types: This alarm will trigger if the compressor VFD reports the Safe Torque Off alarm. This is detected when register 8196 (Active Alarm Group word) bit 13 is set and register 532 (Alarm Code 13) = 1, both for two seconds.
Action Taken:	Rapid shutdown of circuit and lock out from running. Note that VFD will shut down compressor directly in response to this alarm in the VFD. Controller then needs to move circuit to the off state, but compressor should already be turned off by the VFD.
Reset:	With F3 and F4 compressor types: This alarm can be cleared manually via the controller HMI if the VFD is no longer reporting the Safe Disable Input alarm for at least a minute. With 3120 and 3122 compressor types: This alarm can be cleared manually via the controller HMI. When the alarms are cleared in the controller, the command to clear alarms in the VFD's should be sent to them.

High Discharge Temperature

Alarm:	High Discharge Temperature
Displayed Text:	Cn DiscTempHigh
Trigger:	The following are true for 5 seconds: <ul style="list-style-type: none"> Discharge Temp > High Discharge Temp set point Discharge temp sensor fault is not active
Action Taken:	Rapid shutdown of circuit and lock out from running
Reset:	This alarm can be cleared manually via the Unit Controller keypad or via BAS command when Discharge Temp is below the High Discharge Temp set point.

High Oil Pressure Drop

Alarm:	High Oil Pressure Drop
Displayed Text:	Cn Oil PD High
Trigger:	Circuit is in the Start or Run state and Oil Pressure Drop > High Oil Pressure Drop value for a time longer than High Oil Pressure Drop Delay set point. High Oil Pressure Drop value is calculated as shown below. <i>Operating PD = Condenser Pressure – Evaporator Pressure</i> <i>Minimum for High Oil Pressure Difference = High Oil Pressure Difference Minimum set point</i> <i>Maximum for High Oil Pressure Difference = High Oil Pressure Difference Minimum set point + 500 kPa</i> Note that the set point exists individually for each circuit.
Action Taken:	Rapid shutdown of circuit and lock out from running
Reset:	This alarm can be cleared manually via the Unit Controller keypad or via BAS command.

Figure 87: High Oil Pressure Difference Values

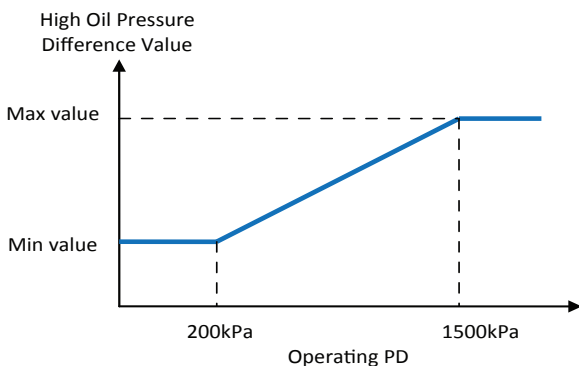

Oil Feed Loss

Alarm:	Oil Feed Loss
Displayed Text:	Cn Oil Feed Loss
Trigger:	The following are true for 20 second: <ul style="list-style-type: none"> Oil Presence Sensor setting is 'Yes' Compressor is running Oil Presence Sensor input is off
Action Taken:	Rapid shutdown of circuit and lock out from running
Reset:	This alarm can be cleared manually via the Unit Controller HMI.

High Motor Temperature

Alarm:	High Motor Temperature
Displayed Text:	Cn Motor Temp High
Trigger:	Compressor VFD reports motor overheat fault. The fault code for this is 0020H.
Action Taken:	Rapid shutdown of circuit and lock out from running
Reset:	This alarm can be cleared manually via the Unit Controller keypad when compressor has been off for at least 5 minutes. When the alarm is cleared in the unit controller, the command to clear the fault in the VFD will be sent.

Compressor Multiple Start Failure

Alarm:	Compressor Multiple Start Failure
Displayed Text:	Cn CompMultiStartFail
Trigger:	This alarm is triggered on the third occurrence of the below conditions within 2 hours. Prior occurrences are events. All of the following must be true to trigger: <ul style="list-style-type: none"> Compressor Run command is on Compressor VFD Communication Failure is not active Either VFD Actual Speed = 0 for more than 15 seconds or VFD Actual Speed < 13 Hz for more than 30 seconds
Action Taken:	Rapid shutdown of circuit and lock out from running
Reset:	This alarm can be cleared manually via the Unit Controller keypad or via BAS command.

No Pressure At Start

Alarm:	No Pressure At Start
Displayed Text:	Cn No Press At Start
Trigger:	All of the following must be true to trigger: <ul style="list-style-type: none"> • Circuit start requested • Condenser Fan VFD Configuration set point = None • Either Evaporator Pressure or Condenser Pressure are less than 35 kPa (5.1 psi)
Action Taken:	Abort start of circuit and lock out from running
Reset:	This alarm can be cleared manually via the Unit Controller keypad or BAS command if Evap Pressure and Cond Pressure are at least 35 kPa (5.1 psi).

Low Discharge Superheat

Alarm:	Low Discharge Superheat
Displayed Text:	Cn Disc SH Low
Trigger:	If all of the following are true for at least 30 minutes, the alarm is triggered: <ul style="list-style-type: none"> • Circuit state is Start or Run • Liquid injection is off • DSH < Low DSH Limit set point
Action Taken:	Normal shutdown of circuit
Reset:	This alarm can be cleared manually via the Unit Controller keypad or via BAS command.

Compressor VFD Current Output High

Alarm:	High Compressor VFD Output Current
Displayed Text:	Cn CmpVFD Curr Out Hi
Trigger 1:	VFD Output Current > Max Motor Current x 1.05 for at least 30 seconds
Trigger 2:	[VFD Output Current > Max Motor Current x 0.99 AND Compressor Speed < 20 Hz] for at least 180 seconds . See the section covering circuit level calculations for the details on the Max Motor Current value.
Action Taken:	Rapid shutdown of circuit and lock out from running.
Reset:	This alarm can be cleared manually via the Unit Controller keypad or via BAS command.

Compressor VFD Current Input High

Alarm:	High Compressor VFD Input Current
Displayed Text:	Cn CmpVFD Curr In Hi
Trigger:	Alarm will trigger when all of the following are true for at least 5 seconds: <ul style="list-style-type: none"> • Unit mode is Ice • Compressor is running • VFD Input Current > Compressor RLA set point x 105% <p>Compressor RLA set point for each circuit is part of the unit configuration.</p>
Action Taken:	Rapid shutdown of circuit and lock out from running
Reset:	This alarm can be cleared manually via the Unit Controller keypad or via BAS command.

Compressor VFD Temperature High

Alarm:	Compressor VFD Temperature High
Displayed Text:	Cn CompVfdTempHigh
Trigger:	VFD Heatsink temperature > Max VFD Temperature for 5 seconds
Action Taken:	Rapid shutdown of circuit and lock out from running
Reset:	This alarm can be cleared manually via the Unit Controller keypad or via BAS command if temperature ≤ Max VFD Temperature.

Compressor VFD Temperature Low

Alarm:	Compressor VFD Temperature Low
Displayed Text:	Cn CompVfdTempLow
Trigger:	This alarm is triggered if the Compressor Type is set as 3120 or 3122 and Compressor VFD Temp ≤ -10°C for at least 5 seconds
Action Taken:	Rapid shutdown of circuit and lock out from running
Reset:	This alarm can be cleared manually via the Unit Controller keypad or via BAS command if Compressor VFD temperature > -5°C.

Compressor VFD Comm Failure

Alarm:	Compressor VFD Comm Failure
Displayed Text:	Cn CompVfdCommFail
Trigger:	Unit has compressor VFD's and there is either a modbus configuration error or there are 10 consecutive modbus commands that failed to receive a valid response.
Action Taken:	Normal shutdown of circuit and lock out from running
Reset:	This alarm can be cleared manually via the Unit Controller keypad or via BAS command if communication has been restored.

CC Module Comm Failure

Alarm:	CC Module Comm Failure
Displayed Text:	CCn Module Comm Fail
Trigger:	Communication with the module has failed. Specifically, this means the reliability value reported for the module is anything other than 0 for at least 3 seconds.
Action Taken:	Rapid shutdown of circuit and lock out from running
Reset:	This alarm can be cleared manually via the keypad or BAS command after reliability value reported for the module is 0 for at least 5 seconds.

EEXV Module Comm Failure

Alarm:	EEXV Module Comm Failure
Displayed Text:	EEXVn Mod Comm Fail
Trigger:	Evaporator Expansion Valve Type is set as an ETS model number (see Table 39) and communication with the module has failed. Specifically, this means the reliability value reported for the module is anything other than 0 for at least 3 seconds.
Action Taken:	Rapid shutdown of circuit and lock out from running
Reset:	This alarm can be cleared manually via the keypad or BAS command after reliability value reported for the module is 0 for at least 5 seconds.

Compressor VFD Fault

Alarm:	Compressor VFD Fault
Displayed Text:	Cn Comp Vfd Fault
Trigger:	<p>F3/F4 compressor types: Fault flag from VFD is set and fault code is not 0020H. Other alarms trigger in response to specific fault codes so if the fault is due to those codes, this alarm should not trigger.</p> <p>With 3120 and 3122 compressor types: There will be a 10 second delay after the controller boots before allowing this alarm to trigger. The alarm will trigger when register 8196 (Active Alarm Group word) ≠ 0 for two seconds and neither of the following alarm trigger conditions are met:</p> <ul style="list-style-type: none"> • Register 8196 (Active Alarm Group word) bit 5 is set and register 524 (Alarm Code 5) = 0 • Register 8196 (Active Alarm Group word) bit 13 is set and register 532 (Alarm Code 13) = 1 <p>The above trigger conditions are for the High Motor Temperature alarm and the Safe Torque Off alarm in the VFD, both are handled as discreet alarms in the controller.</p>
Action Taken:	Rapid shutdown of circuit and lock out from running
Reset:	This alarm can be cleared manually via the Unit Controller keypad or BAS command. When alarm is cleared, command to reset fault should be sent to VFD.

Evaporator Pressure Sensor Fault

Alarm:	Evaporator Pressure Sensor Fault
Displayed Text:	Cn EvapPressSenFault
Trigger:	<p>Trigger any time sensor input voltage is less than 400mv and UC communication with CC module is OK, for at least 1 second.</p> <p>Trigger when sensor input voltage is more than 4600mv and UC communication with CC module is OK, for at least 1 second. However, this trigger should only occur after circuit state is start or run for at least 90 seconds.</p> <p>Trigger if the evaporator approach is less than 1.11°C for more than 100 seconds during the first 5 minutes the compressor is running, and more than 30 seconds thereafter. This trigger should only be enabled after the circuit state is start or run for 30 seconds. The purpose of this trigger condition is to prevent operation if the sensor is reading high but not out of range.</p>
Action Taken:	Rapid shutdown of circuit and lock out from running
Reset:	This alarm can be cleared manually via the keypad or BAS command if sensor input voltage is 400 mv to 4600 mv for at least 5 seconds.

Condenser Pressure Sensor Fault

Alarm:	Condenser Pressure Sensor Fault
Displayed Text:	Cn CondPressSenFault
Trigger:	Trigger any time sensor input voltage is less than 400 mv or more than 4600 mv and UC communication with CC module is OK for at least 1 second.
Action Taken:	Rapid shutdown of circuit and lock out from running
Reset:	This alarm can be cleared manually via the keypad or BAS command if sensor input voltage is 400 mv to 4600 mv for at least 5 seconds.

Oil Pressure Sensor Fault

Alarm:	Oil Pressure Sensor Fault
Displayed Text:	Cn OilPressSenFault
Trigger:	Trigger any time sensor input voltage is less than 400 mv or more than 4600 mv and UC communication with CC module is OK for at least 1 second.
Action Taken:	Normal shutdown of circuit and lock out from running
Reset:	This alarm can be cleared manually via the keypad or BAS command if sensor input voltage is 400 mv to 4600 mv for at least 5 seconds.

Suction Temperature Sensor Fault

Alarm:	Suction Temperature Sensor Fault
Displayed Text:	Cn SuctTempSenFault
Trigger:	<p>Trigger if any of the following are true for at least 1 second:</p> <ul style="list-style-type: none"> • Sensor input value < 340 Ω • Sensor input value > 300 kΩ • Sensor reliability reported by control system ≠ 'No Fault'
Action Taken:	Normal shutdown of circuit and lock out from running
Reset:	This alarm can be cleared manually via the keypad or BAS command if sensor input value is 340 Ω to 300 kΩ and sensor reliability = 'No Fault' for at least 5 seconds.

Discharge Temperature Sensor Fault

Alarm:	Discharge Temperature Sensor Fault
Displayed Text:	Cn DiscTempSenFault
Trigger:	<p>Trigger if any of the following are true for at least 1 second:</p> <ul style="list-style-type: none"> • Sensor input value < 340 Ω • Sensor input value > 300 kΩ • Sensor reliability reported by control system ≠ 'No Fault'
Action Taken:	Normal shutdown of circuit and lock out from running
Reset:	This alarm can be cleared manually via the keypad or BAS command if sensor input value is 340 Ω to 300 kΩ and sensor reliability = 'No Fault' for at least 5 seconds.

Evaporator EXV Motor Error

Alarm:	Evaporator EXV Motor Error
Displayed Text:	Cn EvapExvMotorErr
Trigger:	If EEXV Type is set to E6V and driver in Evaporator EXV module reports EXV motor error. Driver A is for circuit #1 and Driver B is for circuit #2.
Action Taken:	Rapid shutdown of circuit and lock out from running
Reset:	This alarm can be cleared manually via the keypad or BAS command if EXV motor error is no longer being reported.

Power Loss While Running

Alarm:	Power Loss While Running
Displayed Text:	Cn PwrLossWhileRun
Trigger:	Circuit running when controller loses power
Action Taken:	None
Reset:	N/A

Failed Pumpdown

Alarm:	Failed Pumpdown
Displayed Text:	Cn Pumpdown Fail
Trigger:	Circuit state = pumpdown for time > Pumpdown Time set point
Action Taken:	Shut down circuit
Reset:	N/A

Economizer Pressure Sensor Fault

Alarm:	Economizer Pressure Sensor Fault Treat as Warning category if Econ Check Valves set point = No. Treat as Fault category if Econ Check Valves set point = Yes.
Displayed Text:	Cn EconPressSenFault
Trigger:	The following conditions must be true to trigger: <ul style="list-style-type: none"> • Economizer Configuration set point = Yes • 8 seconds have passed since UC booted up • Communication with EVD module is OK Value reported is more than 3083 kPa or less than 3.85 kPa for at least 1 second.
Action Taken:	Warning: Economizer forced to closed state and will remain in closed state. Fault: Normal shutdown of circuit and lock out from running.
Reset:	Warning: This alarm will automatically clear if value reported is from 3.85 to 3083 kPa for five seconds. Fault: This alarm can be cleared manually via the controller HMI or BAS command if value reported is from 3.85 to 3083 kPa for five seconds.

Economizer Temperature Sensor Fault

Alarm:	Economizer Temperature Sensor Fault
Displayed Text:	Cn EconTempSenFault
Trigger:	The following conditions must be true to trigger: <ul style="list-style-type: none"> • Economizer Configuration set point = Yes • Communication with EVD module is OK • Value reported is more than 150°C or less than -40°C for at least 1 second
Action Taken:	Economizer forced to closed state and will remain closed.
Reset:	This alarm will automatically clear if value reported is from -40°C to 150°C for 5 seconds.

Economizer EXV Motor Error

Alarm:	Economizer EXV Motor Error Treat as Warning category if Econ Check Valves set point = No Treat as Fault category if Econ Check Valves set point = Yes
Displayed Text:	Cn EconExvMotorErr
Trigger:	The following conditions must be true to trigger: <ul style="list-style-type: none"> • Economizers set point = Yes • Economizer Check Valves set point • No driver in Economizer EXV module reports EXV motor error Driver A is for circuit 1 and Driver B is for circuit 2.
Action Taken:	Warning: Economizer forced to closed state and will remain in closed state. Fault: Normal shutdown of circuit and lock out from running.
Reset:	Warning: Automatically clear when EXV motor error is not being reported for five seconds. Fault: This alarm can be cleared manually via the controller HMI or BAS command when EXV motor error is not being reported for five seconds.

ECM/DC Fan Motor Fault

Alarm:	DC Fan Motor Fault
Displayed Text:	Cn DcFanMotorFault
Trigger:	Any ECM/DC fan motor on the circuit has a fault as indicated by a flag sent from the DC controller.
Action Taken:	None
Reset:	Fault flag is not set for at least one second. This alarm can be cleared manually via the keypad or BAS command if trigger condition is not true. When the alarm clear command is set via keypad or BAS, a request to clear alarms is sent to the DC controller.

Economizer EXV Module Comm Failure

Alarm:	Economizer EXV Module Comm Failure Treat as Warning category if Econ Check Valves set point = No Treat as Fault category if Econ Check Valves set point = Yes
Displayed Text:	Cn EconExvModCommFail
Trigger:	Econ Refrig = 2 Single, Economizers set point = Yes, and communication with one economizer EXV module has failed. This means that either a modbus configuration error has occurred, or at least 10 consecutive modbus commands failed to receive a valid response.
Action Taken:	Warning: Economizer is moved to closed state and valve command is set to 0% in control logic, though without communication the module is left to operate per logic embedded in it. It should be set up to automatically close the valve when communication is lost. Fault: Normal shutdown of the and lock out circuit from running.
Reset:	This alarm can be cleared manually via the controller HMI or BAS command after communication is restored for at least 5 seconds.

Events

Situations may arise that require some action from the chiller or that should be logged for future reference, but aren't severe enough to track as alarms. These events are stored in a log separate from alarms but accessed through the alarm menu. This log shows the time and date of the latest occurrence, the count of occurrences for the current day, and the count of occurrences for each of the previous seven days.

There is only one unit level event, Unit Power Restore. This is selectable directly from the event log screen. A setting on the

Unit Power Restore screen allows selecting which day to show the count for.

The event log screen also allows selection of either circuit 1 or circuit 2. Each circuit will have its own event log screen. These circuit event log screens have a setting that allows selecting which event to view and a setting to allow selecting which day to show the count for.

Unit Power Restore

Trigger:	Unit controller is powered up.
Action Taken:	None
Reset:	N/A

Low Evaporator Pressure - Hold

Trigger:	This event will trigger when the unit mode is Cool, the circuit state is Run, and evaporator pressure drops below the low evaporator pressure hold value for 5 seconds. Low evaporator pressure hold value = Low Evaporator Pressure Unload set point + Low Evaporator Pressure Hold Offset set point
Action Taken:	Circuit will not be able to increase in capacity.
Reset:	This event is reset when the evaporator pressure rises at least 14 kPa (2.03 psi) above the low evaporator pressure hold value for 3 seconds. It is also reset if the circuit is no longer in the Run state or the unit operating mode is changed to Ice.

Low Evaporator Pressure - Unload

Trigger:	This event will trigger when the unit mode is Cool, the circuit state is Run, and evaporator pressure drops below the Low Evaporator Pressure Unload set point for 5 seconds.
Action Taken:	Compressor speed will decrease by 1 Hz every second.
Reset:	This event is reset when the evaporator pressure rises above the Low Evap Pressure Unload set point for 5 seconds. It is also reset if the circuit is no longer in the Run state or the unit operating mode is changed to Ice.

High Condenser Pressure - Hold

Trigger:	This event will trigger when the unit mode = Cool, compressor is running, and saturated condenser temperature > high saturated condenser hold value for at least 5 seconds.
Action Taken:	Compressor will not be able to increase
Reset:	This event is cleared when the saturated condenser temperature drops at least 2°C below the high saturated condenser hold value for at least 3 minutes. It is also cleared if the circuit is no longer in the Run state or the unit operating mode is changed to Ice.

High Condenser Pressure - Unload

Trigger:	This event will trigger when the unit mode = Cool, compressor is running, and saturated condenser temperature > high saturated condenser unload value for at least one second.
Action Taken:	The compressor speed will decrease 1 Hz every second.
Reset:	This event is cleared when saturated condenser temperature < high saturated condenser unload value for at least 5 seconds. It is also cleared if the compressor is no longer in the Run state or the unit operating mode is changed to Ice.

Low Pressure Difference Or Ratio Shutdown

Trigger:	<p>This event will trigger on the first and second occurrence of the below conditions within 2 hours. A third occurrence within a 2 hour window triggers the alarm.</p> <p>Trigger 1:</p> <p>Pressure ratio is less than 1.6 for longer than the Low Pressure Diff/Ratio Delay set point after circuit state transition to Run. Pressure ratio is calculated as shown with pressures in kPa:</p> $\text{Ratio} = (\text{Condenser Pressure} + 101.325) / (\text{Evaporator Pressure} + 101.325)$ <p>Trigger 2:</p> <p>Pressure difference is less than 180 kPa for longer than the Low Pressure Diff/Ratio Delay set point after circuit state transition to Run. Pressure difference is calculated as shown with pressures in kPa:</p> $\text{Difference} = (\text{Condenser Pressure}) - (\text{Evaporator Pressure})$ <p>Alarm/event cannot trigger for 5 minutes after circuit state transitions to Preopen if OAT < 7°C, however the trigger logic will still run during this window.</p>
Action Taken:	Rapid shutdown of circuit
Reset:	This event resets immediately after triggering.

High VFD Output Current - Unload

Trigger:	<p>This event will trigger when all of the following are true for at least 3 seconds.</p> <ul style="list-style-type: none"> • Unit mode is Cool • Compressor is running • VFD Output Current > Max Motor Current x 0.99
Action Taken:	Compressor speed will be reduced at a rate equivalent to 1 Hz every 2 seconds.
Reset:	This event is cleared when VFD Output Current < Max Motor Current x 0.99. It is also reset if the compressor is not running or the unit operating mode is changed to Ice.

High VFD Line Current Hold

Trigger:	<p>This event will trigger when all of the following are true for at least for 5 seconds.</p> <ul style="list-style-type: none"> • Unit mode is Cool • Compressor is running • VFD Line Current > Compressor RLA set point <p>Compressor RLA set point for each circuit is part of the unit configuration.</p>
Action Taken:	Compressor will not be able to increase speed/capacity.
Reset:	This event is reset when VFD Line Current < Compressor RLA set point x 0.99 for at least 3 minutes. It is also reset when the compressor is not running or the unit operating mode is changed to Ice.

High VFD Line Current Unload

Trigger:	<p>This event will trigger when all of the following are true for at least for 5 seconds.</p> <ul style="list-style-type: none"> • Unit mode is Cool • Compressor is running • VFD Line Current > Compressor RLA set point x 105% <p>Compressor RLA set point for each circuit is part of the unit configuration.</p>
Action Taken:	Compressor speed reduced 1 Hz every 2 seconds.
Reset:	This event is reset when VFD Line Current ≤ Compressor RLA set point x 105%. It is also reset when the compressor is not running or the unit operating mode is changed to Ice.

High VFD Temperature Hold

Trigger:	This event will trigger when all of the following are true for at least for 30 seconds. <ul style="list-style-type: none"> • Unit mode is Cool • Compressor is running • VFD Heatsink Temp > Max VFD Temperature - 6°C
Action Taken:	Compressor will not be able to increase speed/capacity.
Reset:	This event is reset when VFD Heatsink Temp < Max VFD Temperature - 6°C for at least 60 seconds. It is also reset when the compressor is not running or the unit operating mode is changed to Ice.

High VFD Temperature Unload

Trigger:	This event will trigger when all of the following are true for at least for 30 seconds. <ul style="list-style-type: none"> • Unit mode is Cool • Compressor is running • VFD Heatsink Temp > Max VFD Temperature - 3°C
Action Taken:	Compressor speed reduced by 1 Hz every 10 seconds.
Reset:	This event is reset when VFD Heatsink Temp ≤ Max VFD Temperature - 3°C. It is also reset when the compressor is not running or the unit operating mode is changed to Ice.

Compressor Start Failure

Trigger:	This event will trigger on the first and second occurrence of the below conditions within 2 hours. A third occurrence within a 2 hour window triggers the alarm. All of the following must be true to trigger: <ul style="list-style-type: none"> • Compressor Run command is on • Compressor VFD Communication Failure is not active • Either VFD Actual Speed = 0 for more than 15 seconds <u>or</u> VFD Actual Speed < 13 Hz for more than 30 seconds.
Action Taken:	Rapid shutdown of circuit
Reset:	N/A

High VFD Capacitor Current Hold

Trigger:	This event will trigger when all of the following are true for at least 3 seconds: <ul style="list-style-type: none"> • unit mode is cool • compressor is running • Capacitor Current % of Limit ≥ 95% Capacitor Current % of Limit is called rlc in TDE Macno terminology.
Action Taken:	Compressor will not be able to increase speed/capacity
Reset:	This event is reset when VFD Capacitor Current % of Limit ≤ 92% for at least 10 seconds. It is also reset when the compressor is not running or the unit operating mode is changed to Ice.

High VFD Capacitor Current Unload

Trigger:	This event will trigger when all of the following are true for at least 5 seconds: <ul style="list-style-type: none"> • unit mode is cool • compressor is running • Capacitor Current % of Limit ≥ 97% Capacitor Current % of Limit is called rlc in TDE Macno terminology.
Action Taken:	Compressor speed will decrease at a rate equivalent to 1hz every two seconds
Reset:	This event is reset when VFD Capacitor Current % of Limit ≤ 97%. It is also reset when the compressor is not running or the unit operating mode is changed to Ice.

Unit Controller Operation

Figure 88: Unit Controller

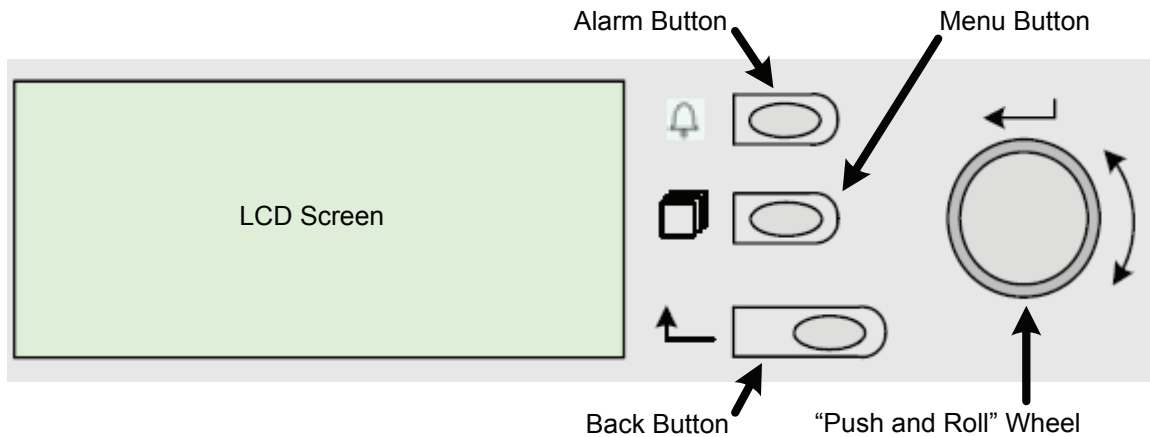

The keypad/display consists of a 5-line by 22-character display, three buttons (keys) and a “push and roll” navigation wheel. There is an Alarm Button, Menu (Home) Button, and a Back Button. The wheel is used to navigate between lines on a screen (page) and to increase and decrease changeable values when editing. Pushing the wheel acts as an Enter Button and will jump from a link to the next set of parameters.

A line in a menu may also be a link to further menus. This is often referred to as a jump line, meaning pushing the navigation wheel will cause a “jump” to a new menu. An arrow is displayed to the far right of the line to indicate it is a “jump” line and the entire line is highlighted when the cursor is on that line.

Figure 89: Typical Screen

▲ ▼	View/Set Unit	3
	Status/Settings	>
	Set Up	>
	Temperatures	>
	Date/Time/Schedule	>

Three types of lines exist:

- Menu title, displayed in the first line as in Figure 89.
- Link (also called Jump) having an arrow (>) in the right of the line and used to link to the next menu.
- Parameters with a value or adjustable set point.

The first line visible on each display includes the menu title and the line number to which the cursor is currently “pointing”, in the above menu representation, “Temperatures” is highlighted.

The leftmost position of the title line includes an “up” arrow ▲ to indicate there are lines (parameters) “above” the currently displayed line; and/or a “down” arrow ▼ to indicate there are lines (parameters) “below” the currently displayed items or an “up/down” arrow to indicate there are lines “above and below” the currently displayed line.

Each line on a screen can contain status-only information or include changeable data fields (set points).

Navigating

When power is applied to the control circuit, the controller screen will be active and display the Home screen, which can also be accessed by pressing the Menu button. The navigating wheel is the only navigating device necessary, although the Menu, Alarm, and Back buttons can provide shortcuts as explained later.

Passwords

There are four levels of access for the user interface:

- No password
- Operator level - 5321
- Technician/Manager level - will be provided at startup
- Daikin Applied service technician level

Enter passwords from the Main Menu:

- Enter Password links to the Entry screen, which is an editable screen. Pressing the wheel goes to the edit mode where the password can be entered. The first (*) will be highlighted; rotate the wheel clockwise to the first number and set it by pressing the wheel. Repeat for the remaining three numbers. The password will time out after 10 minutes with no keypad activity, and is cancelled if a new password is entered or the control powers down.
- Not entering a password allows access to a limited number of parameters.

Information presented at the controller is relative to the password access level; the most extensive menus are available to service technicians.

Entering an invalid password has the same effect as not entering a password.

Once a valid password has been entered, the controller allows further changes and access without requiring the user to enter a password until either the password timer expires or a different password is entered. The default value for this password timer is 10 minutes.

Navigation Mode

When the navigation wheel is turned clockwise, the cursor moves to the next line (down) on the page. When the wheel is turned counterclockwise the cursor moves to the previous line (up) on the page. The faster the wheel is turned the faster the cursor moves. Pushing the wheel acts as an “Enter” button.

When the Back button is pressed, the display reverts back to the previously displayed page. If the Back button is repeatedly pressed, the display continues to revert one page back along the current navigation path until the “main menu” is reached.

When the Menu (Home) button is pressed the display reverts to the “main page.”

When the Alarm button is depressed, the Alarm Lists menu is displayed.

Edit Mode

The Edit Mode is entered by pressing the navigation wheel while the cursor is pointing to a line containing an editable field. Once in the Edit Mode, pressing the wheel again causes the editable field to be highlighted. Turning the wheel clockwise while the editable field is highlighted causes the value to be increased. Turning the wheel counterclockwise while the editable field is highlighted causes the value to be decreased. The faster the wheel is turned the faster the value is increased or decreased. Pressing the wheel again will cause the new value to be saved and the keypad/display to leave the Edit Mode and return to Navigation Mode.

Figure 90: Example of Screen Menu

Main Menu
Enter Password
Quick Menu
View/Set Unit
View/Set Circuit
Unit Status
Active Setpoint

Startup and Shutdown

NOTE: Installation and maintenance are to be performed only by qualified personnel who are familiar with local codes and regulations, and experienced with this type of equipment.

 **DANGER**

LOCKOUT/TAGOUT all forms of hazardous energy and power sources prior to starting, pressurizing, de-pressuring, or powering down the chiller. Failure to follow this warning exactly can result in serious injury or death. Be sure to read and understand the installation, operation, and service instructions within this manual.

Pre-startup

Inspect the chiller to ensure no components became loose or damaged during shipping or installation, including leak test and wiring check. Complete the pre-start checklist at the front of this manual and return to Daikin Applied prior to startup date.

 **CAUTION**

Dyes used for refrigerant leak detection are not tested or recommended for use in Daikin Applied chillers. Use of these products may damage and/or degrade the performance of the equipment and will void the manufacturer warranty.

NOTICE

Daikin Applied service personnel or factory authorized service agency must perform initial startup in order to activate warranty. Return the "Screw Compressor Equipment Warranty Form" within 10 working days to Daikin Applied as instructed on the form to obtain full warranty benefits.

 **CAUTION**

Most relays and terminals in the unit control center are powered when S1 is closed and the control circuit disconnect is on. Therefore, do not close S1 until ready for startup or the unit may start unintentionally and possibly cause equipment damage.

Startup

1. Verify requirements from "Chilled Water Piping" on page 18 are met, including flushing the system water piping **before** connecting to the unit.
2. Verify chilled water flow rate and calibrate thermal dispersion flow switch - see instructions on page 97.
3. Double check that the discharge shutoff valve and the optional compressor suction butterfly valves are open.
4. Check that the manual liquid line shutoff valves at the outlet of the subcooler coils are open.
5. Check the leaving chilled water temperature set point on the MicroTech unit controller to be sure it is set at the desired chilled water temperature.
6. On units with IWSE, torque all IWSE hose clamp connections to a minimum of 75 in-lbs.

7. On units with IWSE, torque IWSE flange bolts to specification, see [Table 65 on page 105](#).
8. Start the auxiliary equipment for the installation by turning on the time clock, and/or remote on/off switch, and chilled water pump.
9. Check to see that pumpdown switches Q1 and Q2 are in the "Pumpdown and Stop" (open) position. Throw the S1 switch to the "Auto" position.
10. Repeat step 7 for Q2
11. Under the "Control Mode" menu of the keypad, place the unit into the automatic Cool Mode.
12. Start the system by moving pumpdown switch Q1 to the "Auto" position.

Temporary Shutdown

Move pumpdown switches Q1 and Q2 to the "Pumpdown and Stop" position. After the compressors have pumped down, turn off the chilled water pump.

 **CAUTION**

Do not turn the unit off using the "Override Stop" switch, without first moving Q1 and Q2 to the "Stop" position, unless it is an emergency, as this will prevent the unit from going through a proper shutdown/pumpdown sequence, resulting in possible equipment damage.

 **CAUTION**

The unit has a onetime pumpdown operation. When Q1 and Q2 are in the "Pumpdown and Stop" position, the unit will pump down once and not run again until the Q1 and Q2 switches are moved to the "Auto" position. If Q1 and Q2 are in the "Auto" position and the load has been satisfied, the unit will go into onetime pumpdown and will remain off until the MicroTech unit control senses a call for cooling and starts the unit.

 **CAUTION**

Water flow to the unit must not be interrupted before the compressors pump down to avoid freeze-up in the evaporator. Interruption will cause equipment damage.

 **CAUTION**

If all power to the unit is turned off, the compressor heaters will become inoperable. Once power is resumed to the unit, the compressor and oil separator heaters must be energized a minimum of 12 hours before attempting to start the unit. Failure to do so can damage the compressors due to excessive accumulation of liquid in the compressor.

Startup After Temporary Shutdown

1. Insure that the compressor and oil separator heaters have been energized for at least 12 hours prior to starting the unit.
2. Start the chilled water pump.
3. With system switch Q0 in the "On" position, move pumpdown switches Q1 and Q2 to the "Auto" position.
4. Observe the unit operation until the system has stabilized.

Extended (Seasonal) Shutdown

1. Move the Q1 and Q2 switches to the Manual Pumpdown position.
2. After the compressors have pumped down, turn off the chilled water pump.
3. Turn off all power to the unit and to the chilled water pump.
4. If fluid is left in the evaporator, confirm that the evaporator heaters are operational.
5. Move the emergency stop switch S1 to the "Off" position.
6. Close the compressor discharge valve and the optional compressor suction valve (if so equipped) as well as the liquid line shutoff valves.
7. Tag all opened compressor disconnect switches to warn against startup before opening the compressor suction valve and liquid line shutoff valves.
8. If glycol is not used in the system, drain all water from the unit evaporator and chilled water piping if the unit is to be shutdown during winter and temperatures below -20°F can be expected. The evaporator is equipped with heaters to help protect it down to -20°F. Chilled water piping must be protected with field-installed protection. Do not leave the vessels or piping open to the atmosphere over the shutdown period.
9. Do not apply power to the evaporator heaters if the system is drained of fluids as this can cause the heaters to burn out.

Startup After Extended (Seasonal) Shutdown

1. With all electrical disconnects locked and tagged out, check all screw or lug-type electrical connections to be sure they are tight for good electrical contact.
2. Check the voltage of the unit power supply and see that it is within the $\pm 10\%$ tolerance that is allowed. Voltage unbalance between phases must be within $\pm 2\%$.
3. See that all auxiliary control equipment is operative and that an adequate cooling load is available for startup.
4. Check all compressor flange connections for tightness to

avoid refrigerant loss. Always replace valve seal caps.

5. Make sure system switch Q0 is in the "Stop" position and pumpdown switches Q1 and Q2 are set to "Pumpdown and Stop". Throw the main power and control disconnect switches to "On." This will energize the crankcase heaters. Wait a minimum of 12 hours before starting up unit. Turn compressor circuit breakers to "Off" position until ready to start unit.
6. Open the optional compressor suction butterfly valves, the liquid line shutoff valves, and compressor discharge valves.
7. Vent the air from the evaporator water side as well as from the system piping. Open all water flow valves and start the chilled water pump. Check all piping for leaks and recheck for air in the system. Verify the correct flow rate by taking the pressure drop across the evaporator and compare to the graphs beginning on [page 46](#).
8. Set the chilled water set point to the required temperature. The system water temperature must be greater than the total of the leaving water temperature set point plus one-half the control band plus the startup Delta-T before the MicroTech unit controller will stage on cooling.
9. Under the "Control Mode" menu of the keypad, place the unit into the automatic Cool Mode.
10. Start the system by moving pumpdown switches to the "Auto" position.

Flow Switch Installation and Calibration

A thermal dispersion flow switch uses heat to determine flow and therefore must be calibrated during system startup. A thermal dispersion flow switch can be an acceptable replacement for paddle type flow switches and differential pressure switches but care must be taken regarding wiring.

The thermal dispersion flow switch supplied by Daikin Applied, shown in Figure 1, comes as a 2 part unit consisting of a flow switch and an adapter labeled E40242 by the supplier.

Figure 91: Thermal Dispersion Flow Switch and Adapter

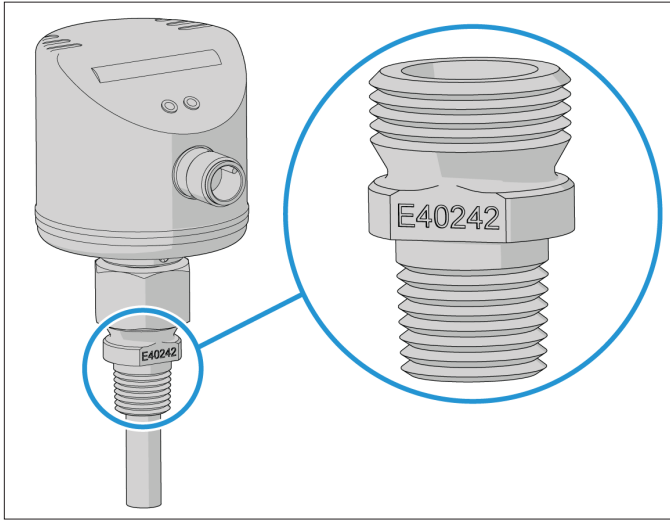

NOTICE
Flow switch MUST be calibrated before chiller operation. Failure to properly calibrate the switch may result in severe chiller damage and/or void warranty.

Mounting

Figure 92 highlights the position of the electrical connector and indentation 'mark' on flow switch.

It is recommended, if possible, that the flow switch be mounted such that the electrical connection and indentation 'mark' are pointed in the direction of flow as shown in Figure 93. It is important that the flow switch be mounted so that the probe is sufficiently inserted into the fluid stream. It may not be mounted directly on top or directly on the bottom of a horizontal pipe.

Figure 92: Flow Switch Details

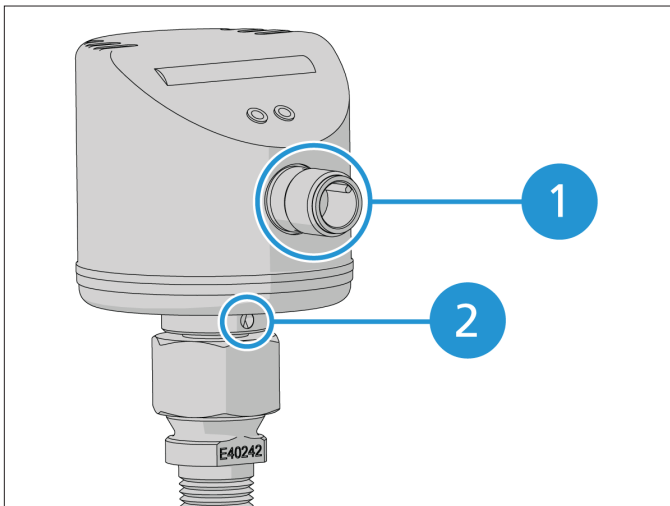

If the flow sensor is to be mounted away from the unit, the sensor should be mounted on the wall of the outlet pipe to the evaporator, or in a run of straight pipe that allows 5 to 10

pipe diameters prior to the sensor and 3 to 5 pipe diameters of straight pipe after the sensor. Flow switch is placed in outlet pipe to reflect flow leaving the barrel. If installation on the inlet pipe is necessary, contact Chiller Technical Response at TechResponse@DaikinApplied.com to review the jobsite details.

NOTE: DO NOT alter or relocate factory installed flow switch. If issues exist, contact Chiller Technical Response at TechResponse@DaikinApplied.com.

If needed, the adapter is threaded into the pipe using pipe sealant appropriate for the application. The flow sensor is mounted onto the adapter using silicone grease. Carefully apply lubricant to the inside threads and o-ring so temperature probe does not become coated with lubricant. Torque the adapter/sensor connection to 18.5 ft/lbs.

Wiring

Refer to wiring diagram in the unit control panel. Either AC or DC is used to power the flow switch. The unit controller's digital input is a DC signal which is supplied through the switch output of the flow switch for flow indication. It is required that the AC and DC commons of power be separated. Contact Chiller Technical Response for alternate wiring scenarios.

Figure 93: Remote Mounting Guidelines for Flow Switch

General		
Recommended		
To avoid		

Flow Switch Setup

The flow switch comes from the factory set at a default velocity of 20 cm/s. This value is typically well below the minimum water flow specified for the unit's evaporator so field adjustment is required for adequate low flow protection. Figure 94 are the calculated gallons per minute (gpm) for Schedule 40 steel pipe for various fluid velocities from 20 cm/s to 300 cm/s. The flow switch has an overall range of adjustment from 3 cm/s to 300 cm/s.

Table 61:

Figure 94: Flow Volume Calculation

Pipe Size (inch)	Inside Pipe Diameter (inch)	US GPM at the velocities indicated below									GPM adjustment per '+' or '-' key input
		Default	20 cm/sec	30 cm/sec	50 cm/sec	75 cm/sec	100 cm/sec	150 cm/sec	200 cm/sec	250 cm/sec	
2	2.06	6.86	10.3	17.2	25.7	34.3	51.5	68.6	85.8	102.9	1.72
2.5	2.46	9.79	14.7	24.5	36.7	49.0	73.4	97.9	122.4	146.9	2.42
3	3.07	15.1	22.7	37.8	56.7	75.6	113.4	151.2	189.0	226.8	3.78
3.5	3.55	20.2	30.3	50.6	75.8	101.1	151.7	202.2	252.8	303.3	5.06
4	4.03	26.0	39.1	65.1	97.7	130.2	195.3	260.4	325.5	390.5	6.51
5	5.05	40.9	61.4	102.3	153.5	204.6	306.9	409.2	511.5	613.7	10.2
6	6.07	59.1	88.6	147.7	221.6	295.5	443.2	590.9	738.7	886.3	14.8
8	7.98	102.3	153.5	255.8	383.7	511.6	767.5	1023.3	1279.1	1534.7	25.6
10	10.02	161.3	241.9	403.2	604.8	806.5	1209.7	1612.9	2016.2	2419.1	39.0
12	11.94	229.0	343.4	572.4	858.6	1144.7	1717.1	2289.5	2861.9	3433.8	57.2
14	13.13	276.8	415.2	692.0	1037.9	1383.9	2075.9	2767.8	3459.8	4151.3	69.2
16	15.00	361.5	542.2	903.6	1355.5	1807.3	2710.9	3614.6	4518.2	5421.2	90.4
18	16.88	457.5	686.3	1143.8	1715.7	2287.6	3431.4	4575.2	5719.0	6862.1	114.4
20	18.81	572.4	853.0	1421.6	2132.4	2843.2	4264.8	5686.4	7108.0	8528.6	142.2

Step 1: Adjust flow through the evaporator to the minimum desired operating gpm. Maintain this flow throughout the setup procedure.

Step 2: Once steady state minimum desired operating flow is obtained, perform the 'Teach' function on the flow switch. The 'Teach' function is initiated by holding down the minus '-' button on the face of the flow switch for 15 seconds. During this 15 second period, LEDs '0' and '9' will be lit green. Once the 'Teach' function is completed, the outer LEDs will flash green as shown in Figure 95.

Figure 95: Automatic Teach of Set point

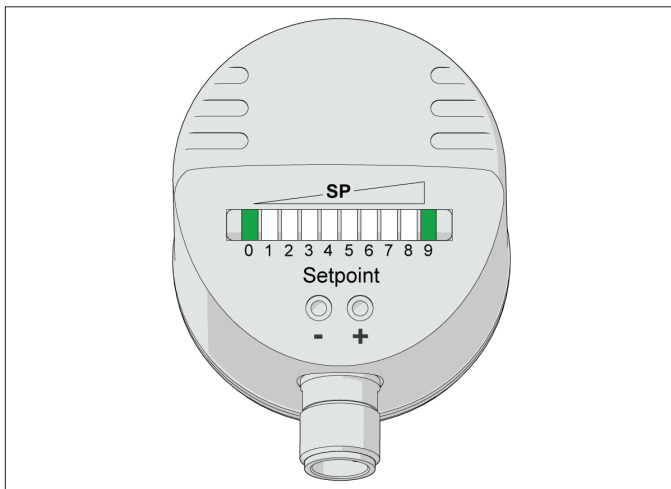

Step 3: After the 'Teach' function is completed and the outer LEDs flashed, the flow switch will indicate a new set point based upon the current flow which should still be at the steady state minimum desired operating flow. Figure 96 shows a

typical display for this condition. All LEDs to the left of the SP LED are lit green. The SP LED is lit RED (or may toggle amber) which indicates that the flow switch is OPEN. Typically, an increase in fluid flow is between 15% to 30% above the 'Teach' function flow is required for the SP LED to turn AMBER and the flow switch to CLOSE indicating acceptable flow.

Figure 96: Teach Adjustment Complete

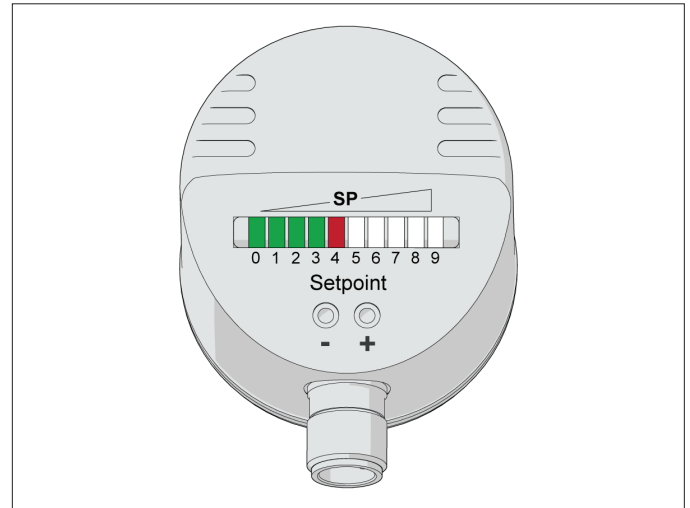

In Step 3, the 'Teach' function re-adjusted the flow switch set point (SP) while flow was at the minimum desired operating flow. The chiller will not operate at this flow because the flow switch is OPEN after performing the 'Teach' function. The benefit of the 'Teach' function is to quickly set the set point within the desired operating range. Additional 'manual' adjustment of set point is required in order to allow for chiller operation at this minimum flow. The '+' and '-' buttons on the face of the flow switch allow for the manual adjustment of the

SP. Pressing the '+' button reduces the flow set point while pressing the '-' button increases the flow set point. Each button press, '+' or '-', changes the flow set point by 2.5 cm/s.

Step 4: Press the '+' button until LED '9' begins to flash. Opening of flow switch should now occur at approximately 80% to 90% of minimum flow.

Figure 97: Upper Range of Minimum Flow

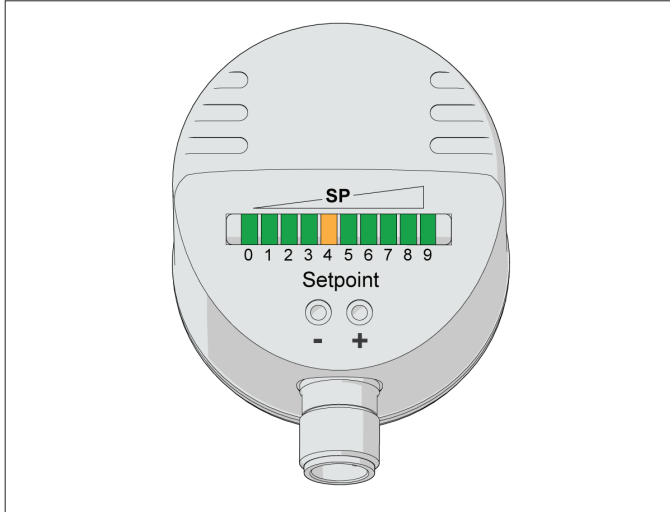

Step 5: Once the SP is set, it is recommended that the sensor be locked to avoid inadvertent readjustment. This can be performed by pressing both the '+' and '-' buttons simultaneously for 10 seconds. The indication goes out momentarily indicating the unit is locked. To unlock, the same procedure is performed to toggle to unlocked.

- NOTE:**
1. The LED window display on flow switch represents a velocity range of 50 cm/s. The window centers on the set point (SP). For example, if the SP was set to 200 cm/s, then the LED labeled '0' would represent a velocity of 180 cm/s when lit and the LED labeled 9 would represent a velocity of 230 cm/s when lit.
 2. Each LED represents 5 cm/s, or two presses of the '+' or '-' buttons.
 3. When power is initially applied to the flow switch, all green LEDs light and go out step by step. During this time, the output is closed. The unit is in the operating mode.
 4. When making manual adjustments to the set point (SP), if no button is pressed for 2 seconds, the unit returns to the operating mode with the newly set value.

Flow below display range: The SP LED will be lit red and the leftmost LED will be flashing green. For example, if the SP was set to 200 cm/s, the flashing labeled '0' would indicate that the flow was below 180 cm/s. This would be shown if no flow through chiller or lowered than desired flow.

Figure 98: Display for Flow Below Range

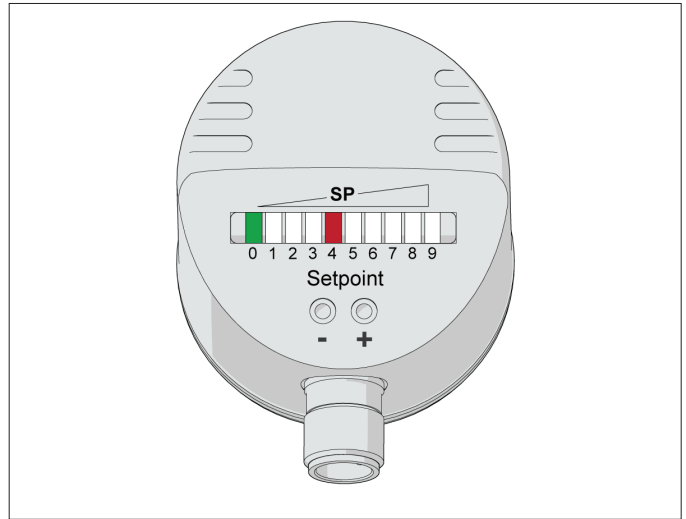

Flow above display range: The SP LED will be lit amber, all LEDs to the left and right of the SP LED will be green with the rightmost LED flashing green. For example, if the SP was set to 200 cm/s, the flashing LED labeled '9' would indicate that the flow was above 230 cm/s. This may be a normal display depending on range by which flow varies through chiller.

Figure 99: Display for Flow Above Range

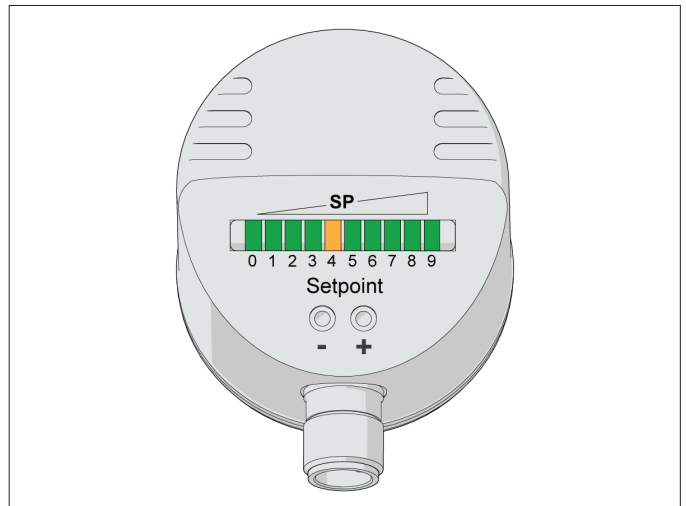

System Maintenance

General

On initial startup and periodically during operation, it will be necessary to perform certain routine service checks. Among these are checking the liquid line sight glasses, and the compressor oil level sight glass. In addition, check the MicroTech unit controller temperature and pressure readings with gauges and thermometers to see that the unit has normal condensing/suction pressure and superheat/subcooling readings. Initial startup date, vibration readings, and oil analysis information should be kept for reference baseline data.

If the service technician has determined that the refrigerant charge has been contaminated, the charge should be recovered and tested for contaminants or noncondensables. Appropriate actions should be taken based on testing and Clean Air Act regulations.

Vibration Monitoring (Optional)

Vibration readings are often used as an indicator of a possible problem requiring maintenance. If vibration monitoring is part of the site PM program, the compressor can be checked with a vibration analyzer on an annual basis. When doing the annual testing, the load should be maintained as closely as possible to the load of the original test. The initial vibration analysis test provides a benchmark of the compressor, and when performed routinely, can give a warning of impending problems.

Lubrication

The fan motor bearings are permanently lubricated. No further lubrication is required. Excessive fan motor bearing noise is an indication of a potential bearing failure.

POE type oil is used for compressor lubrication. This type of oil is extremely hygroscopic, which means it will quickly absorb moisture if exposed to air and form acids that can be harmful to the chiller. Avoid prolonged exposure of refrigerant to the atmosphere to prevent this problem.

 CAUTION
<p>POE oil must be handled carefully using proper protective equipment (gloves, eye protection, etc.). The oil must not come into contact with certain polymers (e.g. PVC) as it may absorb moisture from this material. Do not use oil or refrigerant additives to the system.</p>

 WARNING
<p>Polyolester Oil, commonly known as POE oil is a synthetic oil used in many refrigeration systems, and is present in this Daikin Applied product. POE oil, if ever in contact with PVC/CPVC, will coat the inside wall of PVC/CPVC pipe causing environmental stress fractures. Although there is no PVC/CPVC piping in this product, please keep this in mind when selecting piping materials for your application, as system failure and property damage could result. Refer to the pipe manufacturer's recommendations to determine suitable applications of the pipe.</p>

It is important that only the manufacturer's recommended oil be used. Acceptable POE oil types are:

- CPI/Lubrizol Emkarate RL68H
- Exxon/Mobil EAL Arctic 68
- Hatcol 3693

The compressor oil heater is 250 watts and is on when the compressor is off and off when the compressor is on.

Table 62: Oil Charge per Compressor

Compressor Designation	Oil Quantity (gallons)
3120, 3122	3.43
3AL, 3BL	4.7
4AL	6.6

Oil Filter Removal and Renewal

Prior to this procedure, pump out the compressor. Isolate the electrical supply to the control panels and compressor motor terminal. Filter should be changed when pressure drop delta goes above the linear line in [Figure 100](#).

Figure 100: Pressure Drop to Change Oil Filter

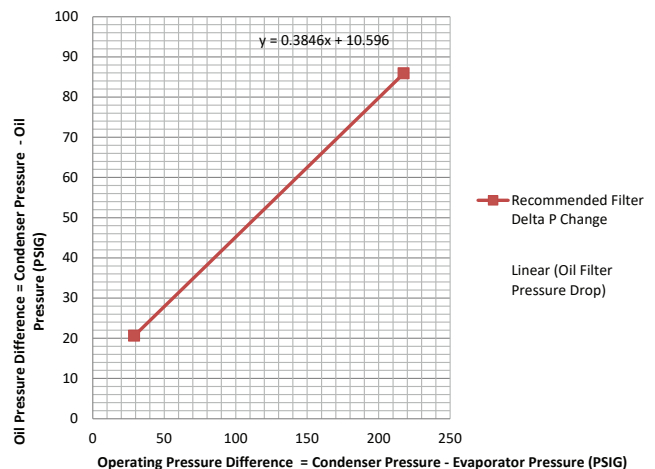
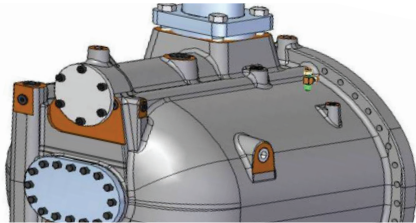
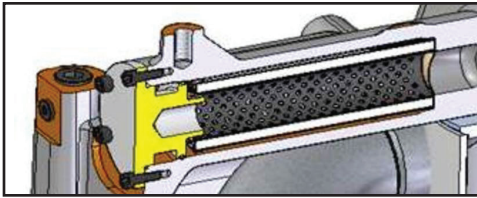

Figure 101: Oil Filter Location (Including Cutaway View)



3. Pull the oil filter off of the spigot and withdraw the oil filter from the housing and clean the housing.



4. Clean oil filter housing cover plate and all other components.

⚠ WARNING

After the compressor has been pumped down and isolated, the oil contained inside the filter housing will remain hot enough to cause burns for some time afterwards. Always allow sufficient time for the oil to cool down so that it is cool enough not to be a danger when drained off (less than 35°C is recommended). Severe injury from burns can result.

Fitting a New Oil Filter Element – Reassembly

Before reassembly, remove any paint from joint faces. Inspect parts individually for damage and ensure they are completely clean before laying them out on a clean surface in a logical order ready for reassembly.

Use fresh refrigerant oil to lubricate parts during reassembly.

1. Install new O-rings on the oil filter housing cover.
2. Insert new oil filter into the housing, ensuring the filter sits tightly on the sealing spigot.
3. Replace the oil filter housing cover.
4. Evacuate air and noncondensables before valving refrigerant back into the compressor.

Figure 102: Oil Filter Housing Cover Plate

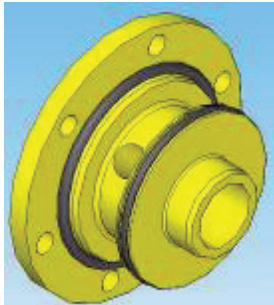

Oil filter assembly components are:

- Oil Filter – 250 mm
- Oil Filter Housing Cover
- O-Ring – 89.5x3
- O-Ring – 76.1x3.4
- (6) M8 Bolts

Disassembly Procedure

1. Unscrew and remove two hex head side cover bolts 180° apart. Insert M8 guide studs into the vacant holes.
2. Remove remaining bolts and oil filter housing cover.

Electrical Terminals

⚠ DANGER

Electric equipment can cause electric shock which will cause severe personal injury or death. Turn off, lock out and tag all power before continuing with following service. Panels can have more than one power source.

⚠ CAUTION

Periodically check electrical terminals for tightness and tighten as required. Always use a backup wrench when tightening electrical terminals.

All-Aluminum Condenser Coils

The condenser coils are an all-aluminum design including the connections, microchannel, fins (an oven brazing process brazes the fins to the microchannel flat tube), and headers (see “Microchannel Coil Cross Section”), which eliminates the possibility of corrosion normally found between dissimilar metals of standard coils.

During the condensing process, refrigerant in the coil passes through the microchannel flat tubes, resulting in higher efficiency heat transfer from the refrigerant to the airstream. In the unlikely occurrence of a coil leak, contact Daikin Applied to receive a replacement coil module.

Figure 103: Microchannel Coil Cross Section

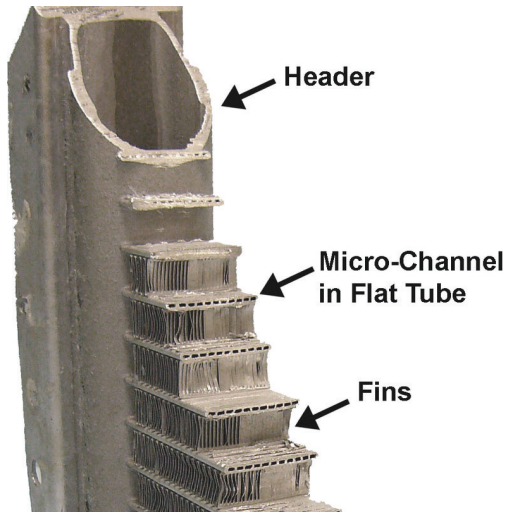

Cleaning Microchannel Aluminum Coils

Maintenance consists primarily of the routine removal of dirt and debris from the outside surface of the fins.

⚠ WARNING

Prior to cleaning the unit, turn off and lock out the main power switch to the unit and open all access panels.

Remove Surface Loaded Fibers

Surface loaded fibers or dirt should be removed prior to water rinse to prevent further restriction of airflow. If unable to back wash the side of the coil opposite that of the coils entering air side, then surface loaded fibers or dirt should be removed with a vacuum cleaner. If a vacuum cleaner is not available, a soft non-metallic bristle brush may be used. In either case, the tool should be applied in the direction of the fins. Coil surfaces can be easily damaged (fin edges bent over) if the tool is applied across the fins.

NOTE: Use of a water stream, such as a hose, against a surface loaded coil will drive the fibers and dirt into the coil. This will make cleaning efforts more difficult. Surface loaded fibers must be completely removed prior to using low velocity clean water rinse.

Periodic Clean Water Rinse

A monthly clean water rinse is recommended for all coils according to Table 63. Coils should be rinsed with water at a lower pressure such as from a hose. Pressure washers are not recommended as the higher pressure may damage the fins.

Regular water rinsing of epoxy coated coils that are applied in coastal or industrial environments will help to remove chlorides, dirt and debris. An elevated water temperature (not to exceed

130°F) will reduce surface tension, increasing the ability to remove chlorides and dirt.

Table 63: Coil Cleaning Guidelines

Coating Option	Recommended Rinsing	Required Cleaning
Aluminum Coil Only	Monthly with low pressure water only	N/A
Epoxy Coated Coil	Monthly with low pressure water only - max 130°F	Quarterly with approved cleaner, Chloride Remover is required - max 130°F

Cleaning Epoxy Coated Coils

The following cleaning procedures are recommended as part of the routine maintenance activities for epoxy coated coils. Documented routine cleaning of epoxy coated coils is required to maintain warranty coverage.

Routine Quarterly Cleaning of Epoxy Coil

Quarterly cleaning is essential to extend the life of an epoxy coated coil and shall be part of the unit's regularly scheduled maintenance procedures. Failure to clean epoxy coated coils will void the warranty and may result in reduced efficiency and durability in the environment.

For routine quarterly cleaning, first clean the coil with a coil cleaner (see Table 64). After cleaning the coils with a cleaning agent, use the chloride remover to remove soluble salts and revitalize the unit.

Recommended Coil Cleaning Agents

The following cleaning agents, used in accordance with the manufacturer's directions on the container for proper mixing and cleaning, have been approved for use on epoxy coated coils to remove mold, mildew, dust, soot, greasy residue, lint and other particulate:

Table 64: Epoxy Coated Coil Recommended Cleaning Agents

Chemical Type	Cleaning Agent
Coil Cleaner	Enviro-Coil Concentrate
Coil Cleaner	GulfCoat™
Chloride Remover	CHLOR*RID®

Chloride remover should be used to remove soluble salts from epoxy coated coils, but the directions must be followed closely. This product is intended to remove chlorides and sulfates and not intended for use as a degreaser. Any grease or oil film should first be removed with the approved cleaning agent.

1. Remove Barrier - Soluble salts adhere themselves to the substrate. For the effective use of this product, the product must be able to come in contact with the salts. These salts may be beneath any soils, grease or dirt; therefore, these barriers must be removed prior to application of this product. As in all surface preparation, the best work yields the best results.
2. Apply chloride remover directly onto the substrate.

Sufficient product must be applied uniformly across the substrate to thoroughly wet out surface with no areas missed. This may be accomplished by use of a pump-up sprayer. The method does not matter, as long as the entire area to be cleaned is wetted. After the substrate has been thoroughly wetted, the salts will be soluble and is now only necessary to rinse them off.

3. Rinse - It is highly recommended that a hose be used as a pressure washer will damage the fins. The water used for the rinse is recommended to be of potable quality, though a lesser quality of water may be used if a small amount of chloride remover is added.

Harsh Chemical and Acid Cleaners

Harsh chemicals, household bleach or acid cleaners should not be used to clean outdoor or indoor epoxy coated coils. These cleaners can be very difficult to rinse out of the coil and can accelerate corrosion and attack the epoxy coating. If there is dirt below the surface of the coil, use the recommended coil cleaners as described above.

High Velocity Water or Compressed Air

High velocity water or compressed air may damage the coil fins and must only be used at a pressure lower than 100 psig and 130°F to prevent fin and/or coil damage. Nozzles must have a diffuse pattern, as a concentrated jet may damage the fins. Never use a pressure washer for coil cleaning. The force of the water or air jet may bend the fin edges and increase airside pressure drop. Reduced unit performance or nuisance unit shutdowns may occur.

 WARNING
Use caution when applying coil cleaners. They can contain potentially harmful chemicals. Wear breathing apparatus and protective clothing. Carefully follow the cleaner manufacturer’s MSDS sheets. Thoroughly rinse all surfaces to remove any cleaner residue. Do not damage the fins.

Liquid Line Sight Glass

Observe the refrigerant sight glasses weekly. A clear glass of liquid indicates that there is adequate refrigerant charge in the system to provide proper feed through the expansion valve.

Bubbling refrigerant in the sight glass, during stable run conditions, may indicate that there can be an EXV problem since the EXV regulates refrigerant flow. Refrigerant gas flashing in the sight glass could also indicate an excessive pressure drop in the liquid line, possibly due to a clogged filter-drier or a restriction elsewhere in the liquid line.

An element inside the sight glass indicates the moisture condition corresponding to a given element color. If the sight glass does not indicate a dry condition after about 12 hours of operation, an oil acid test is recommended.

Do not use the sight glass on the EXV body for refrigerant charging. Its purpose is to view the position of the valve.

Lead-Lag

A feature on all Daikin Applied Pathfinder air-cooled chillers is a system for alternating the sequence in which the compressors start to balance the number of starts and run hours. Lead-Lag of the refrigerant circuits is accomplished automatically through the MicroTech unit controller. When in the auto mode, the circuit with the fewest number of starts will be started first. If all circuits are operating and a stage down in the number of operating compressors is required, the circuit with the most operating hours will cycle off first. The operator can override the MicroTech unit controller, and manually select the lead circuit as circuit #1 or #2.

Pump Operation

It is highly recommended that the chiller unit control the chilled water pump(s). The integral chiller control system has the capability to selectively start pump A or B or automatically alternate pump selection at each start and also has pump standby operation capability.

Failure to have the chiller control the pumps may cause the following problems:

1. If any device, other than the chiller, should try to start the chiller without first starting the pumps, the chiller will lock out on the No Flow alarm and require a manual reset to restart. This can be disruptive to the normal cooling process.
2. In areas where freeze-up is a concern, the chiller control senses the chilled water temperature and turns on an immersion heater in the evaporator. It also signals the chilled water pump to start, providing flow through the evaporator and additional protection against evaporator and outside pipe freeze-up. Other pump starting methods will not automatically provide this protection.

NOTE: The owner/operator must be aware that when the water temperature falls below freezing temperatures it is imperative NOT to stop the pump(s) as immediate freeze-up can occur.

This method of freeze protection is only effective as long as the facility and the chiller have power. The only positive freeze protection during power failures is to drain the evaporator and blow out each tube or add the appropriate concentration of glycol to the system.

Compressor VFD

Inspection Area	Inspection Points	Corrective Action
General	Inspect equipment for discoloration from overheating or deterioration.	Replace damaged equipment as required.
	Inspect for dirt, foreign particles, or dust collection on components	Inspect door seal if so equipped. Use dry air to clear foreign matter.

Inspection Area	Inspection Points	Corrective Action
Conductors and Wiring	Inspect wiring and connections for discoloration, damage or heat stress.	Repair or replace damaged wire.
Terminals	Inspect terminals for loose, stripped, or damaged connections.	Tighten loose screws and replace damaged screws or terminals.
Relays and Contactors	Inspect contactors and relays for excessive noise during operation.	Check coil voltage for over or under voltage condition.
	Inspect coils for signs of overheating such as melted or cracked insulation.	Replace damaged removable relays, contactors or circuit board.

Operation	Weekly	Monthly (Note 1)	Quarterly	Annual (Note 2)
Check liquid line sight glasses for clear flow	X			
Check compressor oil sight glass for correct level (lubricant charge)	X			
Check filter-drier pressure drop (Note 6)		X		
Perform compressor vibration test (optional)				X
Perform oil analysis test on compressor oil				X
Condenser (air-cooled)				
Rinse condenser coils (Note 4)		X		
Clean epoxy coated condenser coils (Note 4)			X	
Check fan blades for tightness on shaft (Note 5)				X
Check fans for loose rivets and cracks, check motor brackets				X
Check coil fins for damage and straighten as necessary			X	
Torque all IWSE hose clamp connections to a minimum of 75 in-lbs				X
Torque IWSE flange bolts to specification 6" pipe flanges: 44 ft lbs. 8" pipe flanges: 55 ft lbs. 10" pipe flanges: 70 ft lbs.				X

Table 65: Preventative Maintenance Schedule

Operation	Weekly	Monthly (Note 1)	Quarterly	Annual (Note 2)
General				
Complete unit log and review (Note 3)	X			
Inspect unit for loose or damaged components and visible leaks		X		
Inspect thermal insulation for integrity				X
Clean and paint as required				X
Electrical (* including the VFDs)				
Sequence test controls *				X
Check contactors for pitting, replace as required *				X
Check terminals for tightness, tighten as necessary *				X
Verify solenoid plug(s) tightness and gasket integrity				X
Clean control panel interior *				X
Clean control box fan filter * (Note 7)	X			
Visually inspect components for signs of overheating *		X		
Verify compressor and oil heater operation		X		
Refrigeration/Lubricant				
Leak test		X		

1. Monthly operations include all weekly operations.
2. Annual (or spring startup) operations include all weekly, monthly, and quarterly operations.
3. Log readings can be taken daily for a higher level of unit observation.
4. Coil rinsing and cleaning can be required more frequently in areas with a high level of airborne particles.
5. Be sure fan motors are electrically locked out.
6. Replace the filter if pressure drop exceeds 20 psi.
7. The weekly fan filter cleaning schedule can be modified to meet job conditions. It is important that the filter allows full air flow.



**DAIKIN APPLIED AMERICAS INC.
LIMITED PRODUCT WARRANTY
(United States and Canada)**

WARRANTY

Daikin Applied Americas Inc. dba Daikin Applied ("Company") warrants to contractor, purchaser and any owner of the product (collectively "Owner") that, subject to the exclusions set forth below Company, at its option, will repair or replace defective parts in the event any product manufactured by Company, including products sold under the brand name Daikin and used in the United States or Canada, proves defective in material or workmanship within twelve (12) months from initial startup or eighteen (18) months from the date shipped by Company, whichever occurs first. Authorized replacement parts are warranted for the remainder of the original warranty. All shipments of such parts will be made FOB factory, freight prepaid and allowed. Company reserves the right to select carrier and method of shipment. In addition, Company provides labor to repair or replace warranty parts during Company normal working hours on products with rotary screw compressors or centrifugal compressors. Warranty labor is not provided for any other products.

Company must receive the Registration and Startup Forms for products containing motor compressors and/or furnaces within ten (10) days of original product startup, or the ship date and the startup date will be deemed the same for determining the commencement of the warranty period and this warranty shall expire twelve (12) months from that date.

For additional consideration, Company will provide an extended warranty(ies) on certain products or components thereof. The terms of the extended warranty(ies) are shown on a separate extended warranty statement.

No person (including any agent, sales representative, dealer or distributor) has the authority to expand the Company's obligation beyond the terms of this express warranty or to state that the performance of the product is other than that published by Company.

EXCLUSIONS

1. If free warranty labor is available as set forth above, such free labor does not include diagnostic visits, inspections, travel time and related expenses, or unusual access time or costs required by product location.
2. Refrigerants, fluids, oils and expendable items such as filters are not covered by this warranty.
3. This warranty shall not apply to products or parts that: (a) have been opened, disassembled, repaired, or altered, in each case by anyone other than Company or its authorized service representative; (b) have been subjected to misuse, abuse, negligence, accidents, damage, or abnormal use or service; (c) have not been properly maintained; (d) have been operated, installed, or startup has been provided in a manner contrary to Company's printed instructions; (e) were manufactured or furnished by others and/or are not an integral part of a product manufactured by Company; (f) have been exposed, directly or indirectly, to a corrosive atmosphere or material such as, but not limited to, chlorine, fluorine, fertilizers, waste water, urine, rust, salt, sulfur, ozone, or other chemicals, contaminants, minerals, or corrosive agents; or (g) have not been fully paid for.
4. This warranty shall not apply to products with rotary screw compressors or centrifugal compressors if such products have not been started, or if such startup has not been performed, by a Daikin Applied or Company authorized service representative.

SOLE REMEDY AND LIMITATION OF LIABILITY

THIS WARRANTY CONSTITUTES THE SOLE WARRANTY MADE BY COMPANY. COMPANY'S LIABILITY TO OWNER AND OWNER'S SOLE REMEDY UNDER THIS WARRANTY SHALL NOT EXCEED THE LESSER OF: (i) THE COST OF REPAIRING OR REPLACING DEFECTIVE PRODUCTS; AND (ii) THE ORIGINAL PURCHASE PRICE ACTUALLY PAID FOR THE PRODUCTS. COMPANY MAKES NO REPRESENTATION OR WARRANTY, EXPRESS OR IMPLIED, REGARDING PREVENTION OF MOLD/MOULD, FUNGUS, BACTERIA, MICROBIAL GROWTH, OR ANY OTHER CONTAMINATES. THIS WARRANTY IS GIVEN IN LIEU OF ALL OTHER WARRANTIES, INCLUDING, WITHOUT LIMITATION, THE IMPLIED WARRANTIES OF MERCHANTABILITY, FITNESS FOR A PARTICULAR PURPOSE, AND NON-INFRINGEMENT, WHICH ARE HEREBY DISCLAIMED. IN NO EVENT AND UNDER NO CIRCUMSTANCE SHALL COMPANY BE LIABLE TO OWNER OR ANY THIRD PARTY FOR INCIDENTAL, INDIRECT, SPECIAL, CONTINGENT, CONSEQUENTIAL, DELAY OR LIQUIDATED DAMAGES FOR ANY REASON, ARISING FROM ANY CAUSE WHATSOEVER, WHETHER THE THEORY FOR RECOVERY IS BASED IN LAW OR IN EQUITY, OR IS UNDER A THEORY OF BREACH CONTRACT OR WARRANTY, NEGLIGENCE, STRICT LIABILITY, OR OTHERWISE. THE TERM "CONSEQUENTIAL DAMAGE" INCLUDES, WITHOUT LIMITATION, THOSE DAMAGES ARISING FROM BUSINESS INTERRUPTION OR ECONOMIC LOSS, SUCH AS LOSS OF ANTICIPATED PROFITS, REVENUE, PRODUCTION, USE, REPUTATION, DATA OR CROPS.

ASSISTANCE

To obtain assistance or information regarding this warranty, please contact your local sales representative or a Daikin Applied office.



Daikin Applied Training and Development

Now that you have made an investment in modern, efficient Daikin Applied equipment, its care should be a high priority. For training information on all Daikin Applied HVAC products, please visit us at www.DaikinApplied.com and click on Training, or call 540-248-9646 and ask for the Training Department.

Warranty

All Daikin Applied equipment is sold pursuant to its standard terms and conditions of sale, including Limited Product Warranty. Consult your local Daikin Applied representative for warranty details. To find your local Daikin Applied representative, go to www.DaikinApplied.com.

Aftermarket Services

To find your local parts office, visit www.DaikinApplied.com or call 800-37PARTS (800-377-2787). To find your local service office, visit www.DaikinApplied.com or call 800-432-1342.

This document contains the most current product information as of this printing. For the most up-to-date product information, please go to www.DaikinApplied.com.

Products manufactured in an ISO Certified Facility.