



**“Emozionare oltre la funzione come solo l’atto creativo sa fare. Elevare il gusto e trasmettere la cultura del glassware e del tableware professionale dando il massimo risalto al contenuto quanto al contenitore.”**

**Italesse dà vita ai propri prodotti studiandone ogni dettaglio, traducendo la funzionalità in emozioni percepite attraverso il gusto e la vista. Know-how professionale e cultura del design guidano ogni atto creativo dell’azienda.**

**“To excite beyond function as only the creative act can. To elevate taste and convey the culture of professional glass and tableware, giving the same emphasis to the product’s contents as to the product itself.”**

**Italesse creates its products by studying every single detail, translating functionality into emotions perceived through taste and sight. Professional know-how and design culture lead every creative act of the company.**

# Indice / Contents

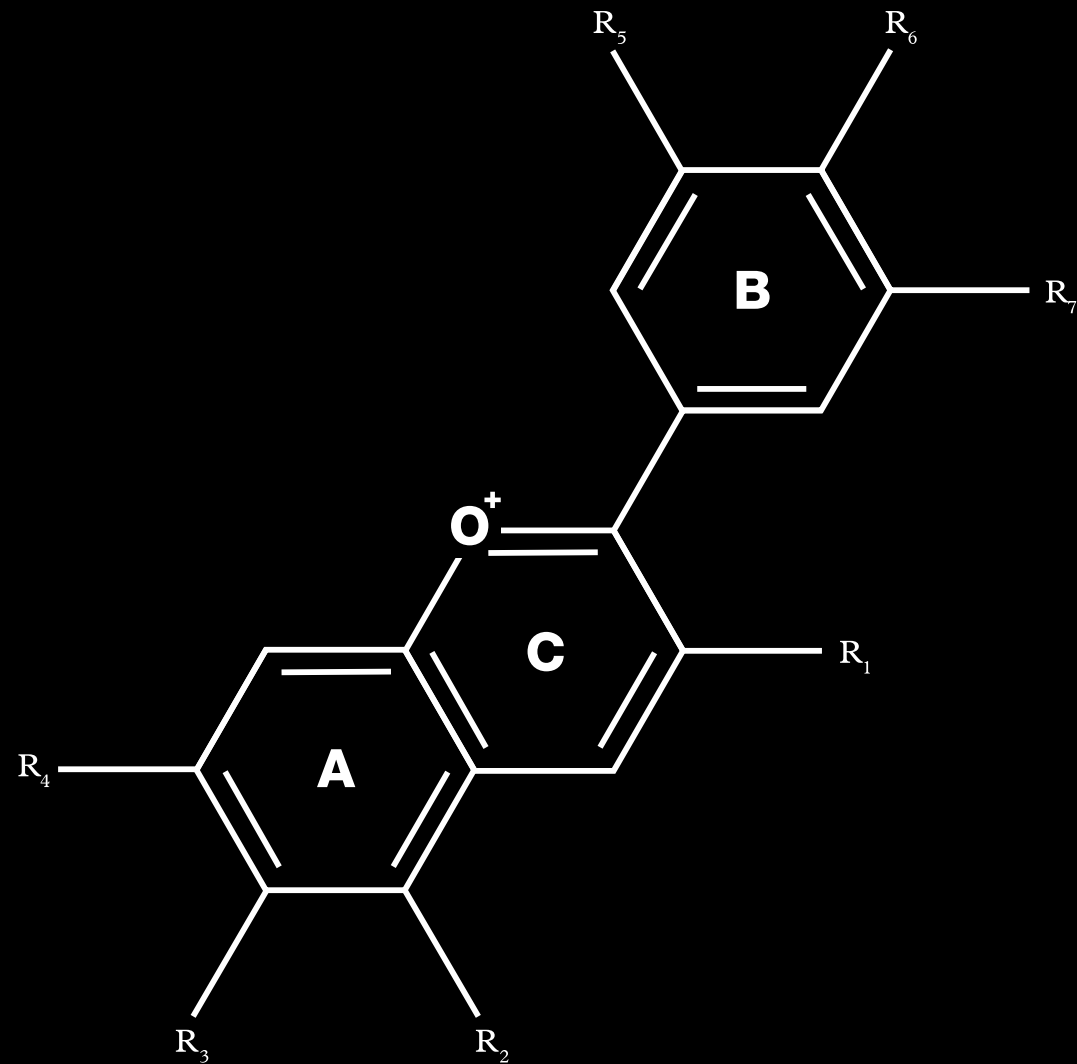

06 Azienda / Company

12 Portfolio

18 Collezioni / Collections

20 Masterclass Collection

24 Etoilé Collection

28 Etoilé Sparkle

30 Balloon Collection

34 Richard Juhlin Optimum

36 Pua Tumbler

40 Vertigo Tumbler

44 Mares Collection

50 Sfera

52 Bolle Tumbler & Bolle Pitcher

56 Wormwood Collection

60 Tiburón Collection

64 Vertical Collection

68 Bora Collection

70 Easy Collection

71 Dolcevíta & Mastro

72 Riviera & Flute N°5

74 Dixie Tumbler

76 Tonic Glass

78 Go Go

80 Premium Collection

82 Beach Collection

86 Air Beach Collection

88 Bolle Beach Tumbler

90 Fresnel Collection

92 Tonic Beach

93 Pachà Beach Light

94 Vas

96 Vertigo Decanter

98 Vinocchio

100 Alavin

Collezioni / Collections

102 Timber Bucket & Bowl

104 Plaza Bucket & Bowl

106 Vela Bucket & Bowl

110 Bolle Bucket & Bowl

114 Solomon Bucket

116 Pagoda Bucket & Gran Pagoda Bowl

118 Tonic Ice Bucket & Bowl

120 Easy Buckets & Bowls

122 Bongo Bucket & Bowl

124 Stainless Steel Collection

126 Aria

128 Wine 360°

130 Stripe

132 Bolle Cake Stand

134 Pebble

137 Djambè Tapas

138 Venti4

140 Lollipop

142 Ocean Stopper

143 Fiesta Stopper & Fiesta Stopper Plus

144 Designers & Opinion Leaders



# Azienda / Company





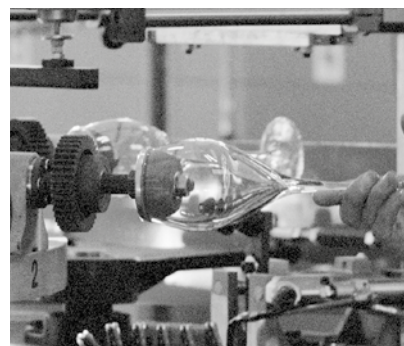
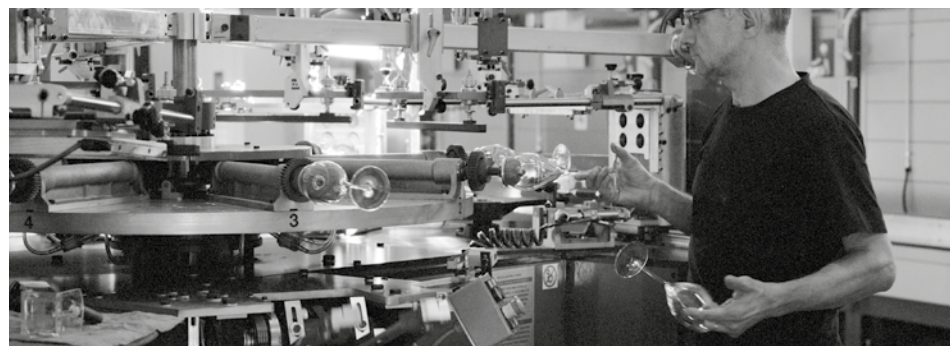
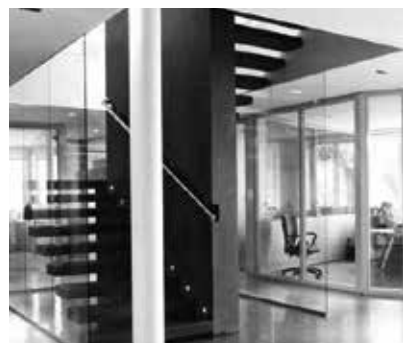

## Italesse, DNA professionale

Fondata nel 1979, Italesse individua da subito nel mercato del beverage una carenza di articoli professionali destinati a valorizzare prodotti come vini e alcolici e, allo stesso tempo, supportare le vendite di brand affermati come strumenti di comunicazione e di immagine. Da un'attenta ricerca tecnica nascono così le prime serie di calici, bicchieri, caraffe, decanter, glacette, e con il tempo viene proposta una gamma completa ed esclusiva di accessori e bottiglie che impongono l'azienda all'attenzione dei più rinomati produttori di vini, champagne ed alcolici internazionali. In breve tempo il marchio vede crescere la propria diffusione anche grazie alla crescente richiesta da parte di hotel, resort e ristoranti che ne decretano il posizionamento nel mondo professionale. Obiettivi chiari, una strategia aziendale coraggiosa e in controtendenza con i tempi che, nella produzione di oggetti premium destinati ad una fascia di mercato medio/alta, radica un'identità aziendale forte, ulteriormente avvalorata da un concept produttivo fondante: fare del binomio forma/funzione la base di una costante ricerca tecnica e formale - materiali innovativi, applicazione del colore, tecnologie all'avanguardia. Dal 2007 l'azienda si rivolge anche al canale retail. Un'implementazione naturale seguita alla collaborazione con figure professionali specializzate ed a una brillante art direction. A completare il processo di espansione l'acquisizione nel 2012 della velvet glass international, azienda top level nella produzione di bottiglie di vetro extra white, che ha consentito ad Italesse di rafforzare l'offerta rivolta ai produttori di distillati, vini, olii ed aceti in cerca di packaging premium. L'attenzione di Italesse ai dettagli, alla qualità dei materiali, all'efficienza tecnica professionale dei prodotti, nonché verso l'atto creativo è, ormai da tempo, affiancata dall'impegno verso temi come l'etica e l'ambiente che ci circonda. Impegno che è stato premiato, al termine del 2019, con la medaglia d'argento EcoVadis, prestigioso riconoscimento internazionale relativo alla sostenibilità.

## Italesse, professional DNA

After its establishment in 1979, Italesse soon noticed a lack of products designed to enhance wine and spirits as well as support the image and sales of well-established brands in the complex beverage market at once. For this reason, after thorough research, the first series of stemware, glasses, carafes, decanters, and glacettes were produced. After some time, a wide and exclusive range of other accessories and high-end bottles followed, which have placed Italesse in the highest ranks among international wine, champagne, and spirits producers. In a short time the brand grew thanks to its success in the hotel, resort, and restaurant world thus entering the Horeca market in which Italesse immediately spotted great potential. Italesse's strong business identity, based on clear objectives and bold counter-trend business strategies, is focused on premium products for the medium to high-end market. These qualities are intertwined with a fundamental production concept using form and function as the foundation for all research, whether it be in innovative materials, ergonomic shapes, the use of colors, or ground-breaking technologies. Since 2007 Italesse has been present in the retail sector, thanks to skilled professionals and an ingenious art direction. To complete its expansion process, the firm acquired Velvet Glass International in 2012, a manufacturer of Luxury Design Glass Bottles. This acquisition has enabled Italesse to reinforce what it offers, addressing the complex needs of producers of wines, liqueurs, oils, and vinegars that seek premium packaging for their products. For some time now, the company's attention for detail, high quality materials, professional and technical efficiency for products, as well as creativity line up with Italesse's awareness for ethics and the environmental concerns that surround us. At the end of 2019 EcoVadis, a prestigious international award relating to sustainability, rewarded the company's commitment for these themes with the silver medal.



## Senses, saper innovare andando oltre le convenzioni

Recentemente Italesse ha ulteriormente ampliato il proprio savoir-faire professionale relativo al mondo del vino con Senses, un progetto che ha come obiettivo finale quello di coniugare emozioni ed eccellenza tecnica nella degustazione. Il team di Italesse Senses ha rivoluzionato il modo di immaginare e progettare i prodotti destrutturando i singoli vini in aromi testando, ad esempio, i calici, sia con il vino, che direttamente con ribes, lamponi, pepe nero; e apportando essenziali modifiche e micro-modifiche alla struttura del bicchiere, per migliorare proprio le percezioni sensoriali ed olfattive. Questo lavoro ha permesso di andare oltre l'idea del calice varietale perché ogni vino è unico e, ad esempio, un pinot nero di una regione è a volte molto diverso da quello di un'altra. Si afferma così l'idea del calice emozionale che rispetta l'unicità di ogni vino e le sensazioni organolettiche ad esso legate.

## Designing around aromas: going beyond the varietal - specific glass

Lately, Italesse further expanded its professional savoir-faire related to the wine world with the new Senses project, which aims to combine emotions and technical excellence in the tasting experience. The Italesse Senses team completely transformed the way the products are designed and imagined, deconstructing the individual wines into aromas by testing, for instance, the stem glass directly with wine as well as with only currants, raspberries, and black pepper. Then comes essential changes - sometimes incredibly tiny - to the stem glass structure, which greatly improves sensorial and olfactory perceptions. The work done by the Italesse Senses team goes beyond the idea of the varietal stem glass because every wine is unique, like a Pinot Noir that can differ greatly from one region to another. The results of this work establishes the idea of the emotional stem glass, which respects the uniqueness of each single wine and its own organoleptic sensations.





# Portfolio

Una collezione di marchi che pongono la qualità al centro dei propri obiettivi e che hanno scelto Italesse per veicolare con forza la propria immagine e portare a termine con successo il proprio business.

A range of companies that, placing quality at the forefront of their business, have chosen Italesse as the vehicle for promoting a strong image and support the success of their activities.

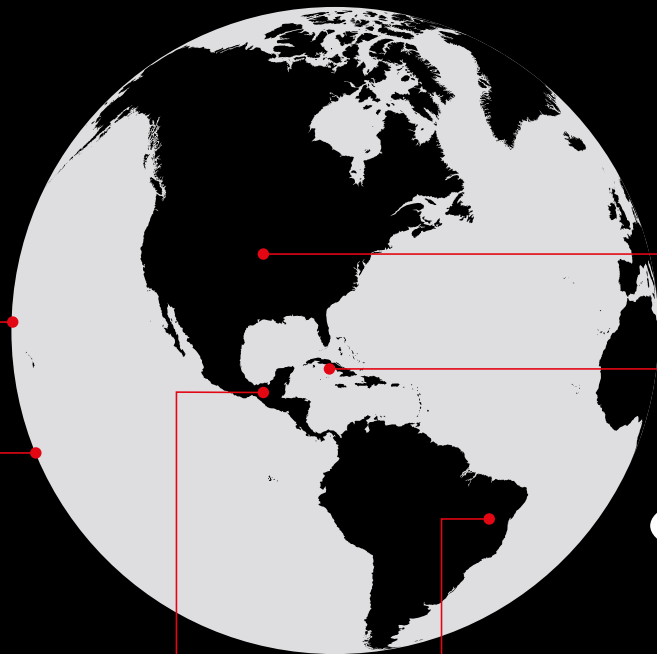

USA

Radisson HOTELS & RESORTS JACOB'S CREEK HYATT

ST. REGIS Hotels & Resorts Hilton HOTELS W

JACK DANIEL'S OLD #7 MARIOTT HOTELS • RESORTS • SUITES GREY GOOSE The World's Best Tasting Vodka

Coca-Cola Sheraton HOTELS & RESORTS

isetan

Japan

SHANGRI-LA HOTELS and RESORTS

Hong Kong

CERVEZA XX DOS EQUIS

Mexico

PISSELLI SUD

HOTEL DEVILLE PRIME Salvador

LUIZ ARGENTA VINHOS e ESPUMANTES

the ASTOR

Brazil

Serapina

REBATAIN

FAMÍLIA GEISSE Vinhedos de Terroir

VARANDA

VINHERIA PERCUSSI 30 ANOS

BACARDI ESTD CUBA 1862

Cuba

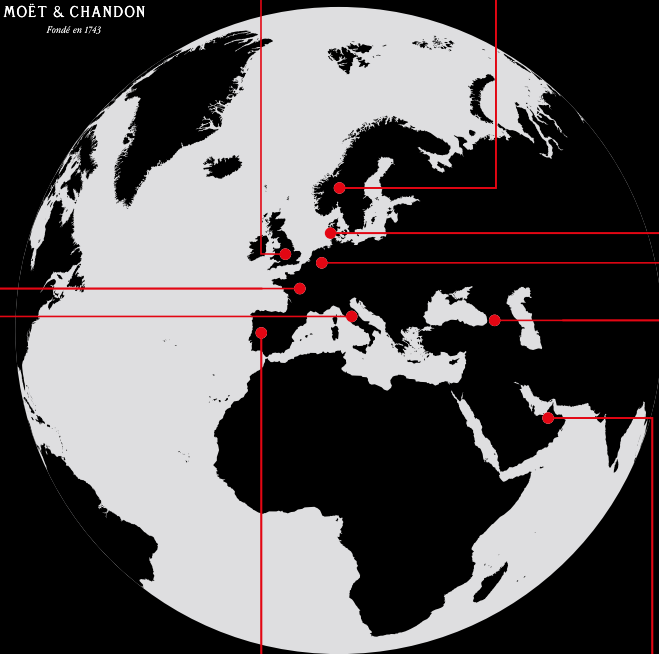

France

buddha-bar CHAMPAGNE G.H. MUMM TETEDOIE

COINTREAU Hennessy COGNAC Paul Bocuse

Pernod Ricard Laurent-Perrier ALAIN DUCASSE

PIPER-HEIDSIECK CHAMPAGNE PERRIER-JOUET MOËT & CHANDON Fondé en 1743

Veuve Clicquot Ponsardin CHAMPAGNE BOLLINGER

United Kingdom

BOMBAY SAPPHIRE

INTERCONTINENTAL HOTELS & RESORTS

BVLGARI HOTELS & RESORTS

Sweden

Nobis Hotel

ABSOLUT VODKA

Denmark

Carlsberg

Holland

Heineken

Berlusconi BERLUCCHI 1961-2011

APEROL CAMPARI

la Rinascente S.PELLEGRINO MIONETTO VALDOBBIADENE

NASTRO AZZURRO. roberto cavalli VODKA FERRARI METODO CLASSICO DAL 1902

MARTINI HOTEL MISSONI L'ALBERETA

Italy

BARBADILLO

San Miguel TORRES

Freixenet Mahou

Spain

BURJ AL ARAB

United Arab Emirates

ERISTOFF

Georgia



# Personalizzazioni e decorazioni / Personalization & Decoration

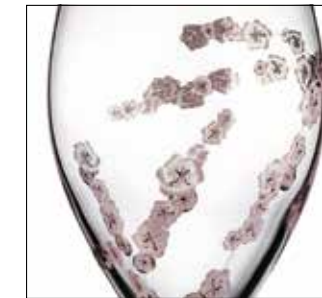

# **Collezioni / Collections**



## Masterclass Collection

*Per i professionisti della degustazione, la collezione Masterclass è progettata per esaltare l'approccio sensoriale di ogni vino, sovvertendo l'idea del calice varietale con quella del calice emozionale.*

*La collezione è disponibile in vetro Excellence o Xtreme® | For tasting professionals, Masterclass Collection is designed to enhance the sensorial approach of each wine, subverting the varietal stemware idea with that of the emotional stem stemware. The Collection is available in Excellence crystal glass or Xtreme®*

design by ITALESSE



**IT** Calici studiati per offrire le migliori prestazioni professionali possibili ed esaltare l'approccio visivo, olfattivo e gustativo del vino. La collezione è realizzata in vetro cristallino Excellence, soffiato a bocca e lavorato a mano, o in vetro Xtreme® straordinario per resistenza. Il design e un punto inciso a laser nella base, che valorizza il perlage, rendono Masterclass 48 adatto per servire anch'esso Champagne e spumanti, e al tempo stesso vini rosé e bianchi freschi. Masterclass 50 è un calice eccellente per esaltare vini bianchi ma anche rossi particolarmente eleganti e freschi. Il Masterclass 70 è perfetto per degustare champagne complessi, bianchi corposi e rossi giovani ed eleganti. Masterclass 90, dalle forme generose ed eleganti, è un calice studiato per vini rossi pregiati e corposi, ma straordinario anche per bianchi strutturati e complessi che richiedono una particolare ossigenazione. Completa la collezione il nuovo Masterclass Tumbler, straordinario per l'eleganza delle forme e per l'estrema leggerezza.

**EN** Stemware designed to offer the best available performance as well as enhance the visual appearance, smell, and taste approach to wine. The Collection is made in Excellence mouth-blown and handmade crystal glass or in Xtreme® extraordinarily resilient crystal glass. The design and the laser cut point on the piqûre that valorize the perlage make Masterclass 48 a stem glass likewise ideal to serve Champagne and sparkling wines as well as rosé wines and fresh whites. Masterclass 50 is an excellent stem glass that enhances particularly fresh and elegant whites and reds alike. Masterclass 70 is perfect for tasting complex Champagne, structured whites as well as young and elegant reds. Masterclass 90, with generous and elegant shapes, designed for prized and structured red wines, is also suited to glorify structured and complex whites that need a particular oxygenation. The new entry, the Masterclass Tumbler, extraordinary for its elegant shapes and extreme lightness, completes the collection.



#### MASTERCLASS 90

art. 3367 - Excellence  
art. 3364 - Xtreme®

MATERIALE / MATERIAL  
Vetro cristallino Excellence soffiato a bocca e lavorato a mano. Vetro cristallino Xtreme® / Excellence mouth-blown hand-crafted crystalline glass. Xtreme® crystalline glass.

CAPACITÀ / CAPACITY  
950 cc / 32 oz

COLORI / COLOURS  
Clear

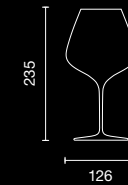

#### MASTERCLASS 50

art. 3375 - Xtreme®

MATERIALE / MATERIAL  
Vetro cristallino Xtreme® / Xtreme® crystalline glass.

CAPACITÀ / CAPACITY  
520 cc / 18 oz

COLORI / COLOURS  
Clear



#### MASTERCLASS 70

art. 3366 - Excellence  
art. 3363 - Xtreme®

MATERIALE / MATERIAL  
Vetro cristallino Excellence soffiato a bocca e lavorato a mano. Vetro cristallino Xtreme® / Excellence mouth-blown hand-crafted crystalline glass. Xtreme® crystalline glass.s

CAPACITÀ / CAPACITY  
720 cc / 24 ¼ oz

COLORI / COLOURS  
Clear



#### MASTERCLASS 48

art. 3365 - Excellence  
art. 3362 - Xtreme®

MATERIALE / MATERIAL  
Vetro cristallino Excellence soffiato a bocca e lavorato a mano. Vetro cristallino Xtreme® / Excellence mouth-blown hand-crafted crystalline glass. Xtreme® crystalline glass.

CAPACITÀ / CAPACITY  
480 cc / 16 ¼ oz

COLORI / COLOURS  
Clear



#### MASTERCLASS TUMBLER

art. 3375 - Excellence

MATERIALE / MATERIAL  
Vetro cristallino Excellence soffiato a bocca e lavorato a mano / Excellence mouth-blown hand-crafted crystalline glass

CAPACITÀ / CAPACITY  
460 cc / 15 ½ oz

COLORI / COLOURS  
Clear







## Etoilé Collection

*Elegante, sinuosa, di classe, curata nei dettagli per rendere l'esperienza d'uso emozionale: è così che si presenta la Collezione Etoilé sulle tavole dei ristoranti stellati e più raffinati. Per il loro stile e performance sono diventati i calici ufficiali dell'Associazione Maîtres Cuisiniers de France | Elegant, sinuous, fancy, cured in all details to give a full emotional experience: that is how it looks the new Etoilé Collection on the tables of the most elegant and Michelin Star Restaurants. For their style and performances they are the official stemware of the Maîtres Cuisiniers de France Association*

**IT** Progettati per superare il concetto di bicchiere varietale, gli Etoilé sono calici professionali che esaltano le proprietà organolettiche di tutte le tipologie di vino. Etoilé Blanc è ideale per esaltare la freschezza dei vini bianchi, il d'Or è una flûte di tipo tradizionale pensata per godere l'intensità di Champagne e spumanti, il Noir è un calice perfetto per i rossi giovani ed eleganti mentre il Platinum ha proporzioni pensate per esaltare i vini bianchi e rossi di struttura. Il calice Sparkle si presenta invece come una vera rivoluzione per il mondo della degustazione di spumanti e Champagne: coppa più ampia, corpo elegantemente alto e ben sette punti di perlage.

**EN** Designed to overcome the varietal stemware concept, the Etoilé are professional stemware that enhance the organoleptic characteristics of all the wine types. Etoilé Blanc is ideal to enhance the freshness of white wines, the D'Or is a traditional flûte designed to enjoy the intensity of Champagne and sparkling wines, while the Platinum's proportions are thought for enhance structured white and red wines. The Sparkle, instead, is a revolution in tasting Champagne and sparkling wines with its wider bowl, elegant height, and seven perlage points. The Etoilé Cristal tumbler, extraordinary for water, completes the collection.



## ETOILÉ NOIR

art. 3347 - Excellence  
art. 3361 - Xtreme®

MATERIALE / MATERIAL  
Vetro cristallino Excellence soffiato a bocca e lavorato a mano o vetro cristallino Xtreme® soffiato in automatico in assenza di piombo / Excellence mouth blown, hand-crafted, lead-free crystal glass or lead free automatically blown crystalline Xtreme® glass

CAPACITÀ / CAPACITY  
760 cc / 25 ¾ oz (Excellence)  
790 cc / 26 ¾ oz (Xtreme®)

COLORI / COLOURS  
Clear

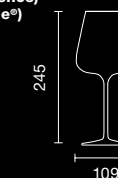

## ETOILÉ BLANC

art. 3346 - Excellence  
art. 3360 - Xtreme®

MATERIALE / MATERIAL  
Vetro cristallino Excellence soffiato a bocca e lavorato a mano o vetro cristallino Xtreme® soffiato in automatico in assenza di piombo / Excellence mouth blown, hand-crafted, lead-free crystal glass or lead free automatically blown crystalline Xtreme® glass

CAPACITÀ / CAPACITY  
550 cc / 18 ½ oz (Excellence)  
570 cc / 19 ¼ oz (Xtreme®)

COLORI / COLOURS  
Clear



## ETOILÉ D'OR EXCELLENCE

art. 3057

MATERIALE / MATERIAL  
Vetro cristallino Excellence soffiato a bocca e lavorato a mano / Excellence mouth-blown, hand-crafted lead-free crystal glass

CAPACITÀ / CAPACITY  
330 cc / 11 oz

COLORI / COLOURS  
Clear

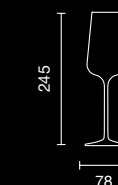

## ETOILÉ PLATINUM EXCELLENCE

art. 3075

MATERIALE / MATERIAL  
Vetro cristallino Excellence soffiato a bocca e lavorato a mano / Excellence mouth-blown, hand-crafted lead-free crystal glass

CAPACITÀ / CAPACITY  
660 cc / 22 ¼ oz

COLORI / COLOURS  
Clear



## ETOILÉ CRISTAL

art. 3348 - Excellence  
art. 3359

MATERIALE / MATERIAL  
Vetro cristallino Excellence soffiato a bocca e lavorato a mano o vetro / Excellence mouth-blown, hand-crafted lead-free crystal glass or glass

CAPACITÀ / CAPACITY  
400 cc / 13 ½ oz

COLORI / COLOURS  
Clear





# Etoilé Sparkle

*Un calice che ha il sapore della sfida e il fascino dell'innovazione. Etoilé Sparkle è un prodotto unico, ideato da Luca Bini e dedicato alla degustazione degli spumanti ottenuti con metodo classico / A stem glass that carries with it the spirit of challenge and the wonder of innovation. Etoilé Sparkle is a unique piece, conceived by Luca Bini and intended for the tasting of sparkling wines made using the classic method*

design by LUCA BINI



## Chiusura della bocca stretta

Con una bocca stretta, il calice ricorda la silhouette di un tulipano chiuso e coniuga una completa esperienza di degustazione a un design armonico ed elegante. La particolare chiusura incanala l'aroma dei vini verso il naso e la bocca.

**Narrow mouth diameter.** The glass takes the form of a closed tulip, designed to bring harmony and elevate the tasting experience. This stem glass features a narrow mouth that channels the wine's aromas to the nose and mouth.

## Fondo piano e larghezza della coppa

Evocando l'iconica coppa di Champagne, il fondo di Sparkle è volutamente ampio, al fine di permettere al perlage di salire in superficie e, così facendo, di raccogliere aromi e profumi nel centro della coppa. Sparkle infatti, è disegnato per esaltare tutte le caratteristiche organolettiche del vino senza perdere le qualità pregiate, evitando così il limite tecnico comunemente associato alla coppa.

**Flat base and bowl width.** Evoking the iconic Champagne coupe, the bowl of this unique sparkling wine glass is intentionally broad to allow the perlage to quickly rise to the surface and by doing so, release its fragrant qualities. In contrast with the open coupe, however, aromas collect in the middle of the glass by virtue of the bowl's tapering shape. Sparkle's features hence allow for the full expression of the wine's organoleptic attributes without dispersing them; a technical limitation of the coupe.

## Punti perlage

Sei incisioni equidistanti tra loro lungo una circonferenza di raggio 20 millimetri e una centrale posizionata immediatamente sopra allo stelo del calice: Sparkle propone un innovativo sistema di perlage, in grado di accrescerlo, animando così il vino e intensificando l'esperienza della degustazione. L'effetto visivo prolunga il fascino della degustazione e risveglia i sensi.

**Perlage points.** Six equidistant micro-incisions etched in a 20mm circumference on the bowl's base and another placed centrally over the glass's stem are an important feature of Sparkle. These etchings serve to promote and heighten perlage, enlivening the wine and enhancing the wine tasting experience. The perlage opens up the wine's subtlest flavors and ensures a lasting visual effect.



## Altezza della coppa, pareti affusolate

Sparkle si presenta con pareti affusolate e ripide che reinterpretano la forma della tradizionale flûte, il classico senza tempo per la degustazione di Champagne e spumanti. La coppa è ideata per dirigere il vino direttamente alla lingua, e per consentire così una valutazione immediata della qualità.

**Bowl height and straight, tapering walls.** Sparkle possesses straight walls that reinterpret those of the traditional flute, a timeless classic for tasting Champagnes and sparkling wines. This stemware, revives these elements in its own contemporary key to direct the flow of the wine directly onto the tongue, allowing for an immediate appreciation of the vintage's qualities.

## Fascino e tecnica

La lunghezza e l'eleganza del gambo unisce fascino e tecnica al calice. Oltre a creare un effetto scenico, posizionando la mano alla giusta distanza dal calice, la dimensione dello stelo evita il trasferimento del calore, garantendo l'ottimale temperatura di degustazione.

**Long, elegant stem.** Aside from adding allure to the design, this long, elegant stem also carries a functional purpose. The length of the stem ensures the hand holds the glass at an ideal distance from the wine to avoid the transfer of heat and guarantee the glass's contents remain at an optimal temperature for tasting.

ETOILÉ SPARKLE

art. 3062 - Excellence  
art. 3055 - Xtreme®

MATERIALE / MATERIAL  
Vetro cristallino Excellence soffiato a bocca e lavorato a mano o vetro cristallino Xtreme® soffiato in automatico in assenza di piombo / Excellence mouth blown, hand-crafted, lead-free crystal glass or lead free automatically blown crystalline Xtreme® glass

CAPACITÀ / CAPACITY  
480 cc / 16 ½ oz

COLORI / COLOURS  
Clear







## Balloon Collection

*Flûte che rievocano le forme dei calici da vino tradizionali balloon, realizzati per una proposta di servizio innovativo in linea con le nuove tendenze di degustazione e di consumo del mondo dello Champagne - scenico ed elegante | Flutes that evoke the silhouette of traditional wine tasting balloon glasses and deliver an innovative proposal for service that follows the latest tasting and consumption trends in Champagne - dramatic, sophisticated*



**IT** La serie Balloon si compone di tre calici: Balloon Flûte, Grand Balloon Flûte e Balloon Magnum Flûte, tutti caratterizzati da ampie coppe disegnate per sviluppare gli aromi di Champagne e vini spumanti e da bocca chiusa per indirizzarli ai sensi nella degustazione. Una profonda piquère, con un punto perlage inciso al laser, esalta la qualità, la finezza e la persistenza delle catenelle di bollicine. Il Balloon Magnum Flûte si distingue per la sua realizzazione con un vetro soffiato a bocca e lavorato a mano Excellence®. Balloon Flûte e Grand Balloon Flûte sono realizzati con vetri Xtreme® resistenti agli urti, alla torsione e alle rotture nel punto critico di saldatura tra gambo e piattello. Balloon Magnum Flûte si differenzia per la produzione in vetro soffiato a bocca e lavorato a mano: la sua coppa ampia è ideale per la degustazione dei più pregiati Champagnes che necessitano di particolare ossigenazione.

**EN** The Balloon Flute series is composed of three elements: the Balloon Flute, the Grand Balloon Flute and the Balloon Magnum Flute, all featuring the same forms characterized by ample bowls designed to develop the delicate aromas of Champagne and sparkling wines, channeled towards the senses when tasting by virtue of its tapering mouth. A deep piquère at the base of the flute's bowl that possesses a laser-etched perlage point enhances the quality, finesse and persistence of wine's effervescence. The Balloon Flute and the Grand Balloon Flute are produced using Xtreme® patented glass, resistant to shocks and torsion as well as breakage at the critical fusion point between the stem and the base plate. The Balloon Magnum Flute, distinguishing itself by its prized mouth-blown hand-made Excellence® quality glass, possesses a particularly large bowl that makes it perfect for tasting of the most prized Champagnes that require optimum oxygenation.



## BALLOON MAGNUM FLÛTE

art. 3037

MATERIALE / MATERIAL  
Vetro cristallino Excellence® soffiato a bocca e lavorato a mano / Excellence® mouth-blown hand-crafted crystalline glass

CAPACITÀ / CAPACITY  
450 cc / 15 ¼ oz

COLORI / COLOURS  
Clear

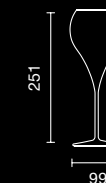

## GRAND BALLOON FLÛTE

art. 3036

MATERIALE / MATERIAL  
Vetro Xtreme® soffiato in automatico in assenza di piombo / Automatically blown, lead free Xtreme® glass

CAPACITÀ / CAPACITY  
380 cc / 12 ¾ oz

COLORI / COLOURS  
Clear



## BALLOON FLÛTE

art. 3035

MATERIALE / MATERIAL  
Vetro Xtreme® soffiato in automatico in assenza di piombo / Automatically blown, lead free Xtreme® glass

CAPACITÀ / CAPACITY  
210 cc / 7 oz

COLORI / COLOURS  
Clear



## Richard Juhlin Optimum

*Flûte professionale per la degustazione dello Champagne: da un'intuizione di Italesse, il calice Optimum prende forma grazie alla collaborazione di Richard Juhlin, uno dei massimi esperti internazionali di Champagne, con Claesson Koivisto Rune, uno dei più apprezzati atelier di design nel mondo | A professional Flûte based on the intuition of Italesse, the Richard Juhlin Optimum has taken shape thanks to the collaboration between Richard Juhlin, one of the top international Champagne experts, and Claesson Koivisto Rune, one of the most appreciated design firms in the world*

concept by RICHARD JUHLIN  
design by CLAESSON KOIVISTO RUNE

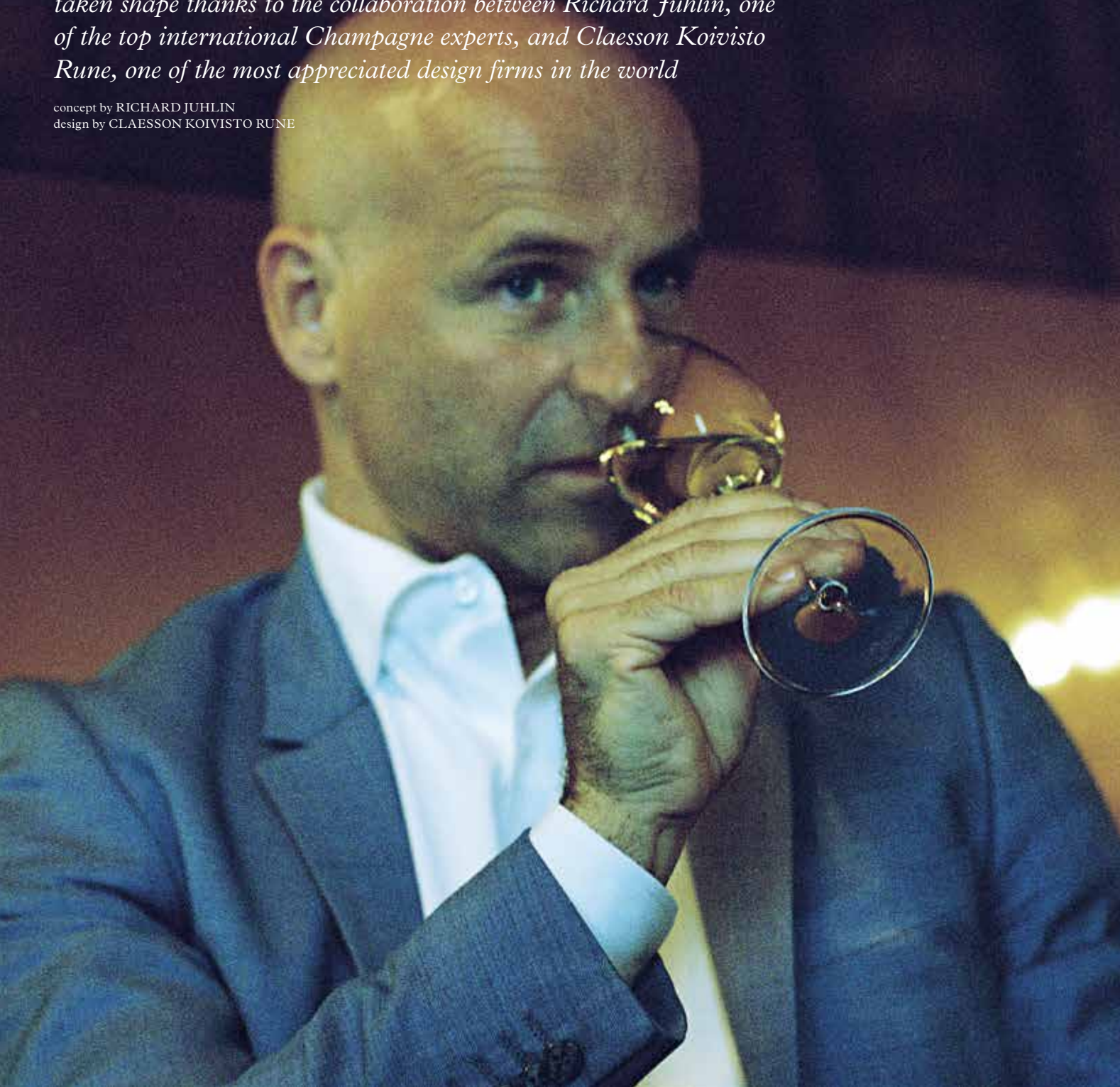

### Diametro della bocca

Il bevande è proporzionato all'altezza e all'angolo della coppa. La bocca è chiusa tanto quanto basta per permettere allo Champagne di indirizzare al naso fragranze e aromi nel migliore modo possibile.

**Mouth diameter.** The rim is proportional to the height and angle of the bowl. It is closed just enough to allow the Champagne to direct the fragrances and aromas perfectly towards the taster's nose.

### Ampiezza della coppa

Il diametro massimo della coppa corrisponde al livello ottimale di servizio: è quell'ottimale superficie di Champagne, che esposta all'aria sovrastante e contenuta nella coppa, rilascia gli aromi e le fragranze nel modo più efficace possibile. È a questo livello (9cl.) che è stata apposta (su una versione del calice da Champagne) una linea decorativa e funzionale.

**Bowl width.** The maximum diameter of the bowl corresponds to an optimal quantity and surface area exposure of Champagne to the air. This is the "Juhlin line", the ideal measurement for releasing Champagne aromas and fragrances in the best possible manner.

### Punto Perlage e piqûre

Il fondo della coppa del calice ospita una profonda piqûre, dove si formano le bollicine (propagate al centro della coppa) e dove il punto laser perlage moltiplica l'effetto, generando una maggiore quantità di bollicine.

**Perlage Point and Piqûre.** The bowl depth is conceived to favour perlage in the centre of the glass, for perfect tasting. Inside the piqûre, on the bottom, there is a circular ring comprised of numerous small micro-etchings on the glass surface: this is the perlage point. When the Champagne is poured into the glass long bubble chains are produced (known as perlage) and the effect is long-lasting.

### Altezza della coppa

La dimensione totale della coppa è studiata tecnicamente ed è perfettamente bilanciata. Sia nella profondità della picure nella parte bassa, che nell'altezza e nell'angolazione di chiusura della coppa nella parte superiore – detta cheminée – per concentrare e canalizzare gli aromi e i profumi verso il naso e la bocca.

**Bowl Height.** Perfectly balanced dimensions along the entire height of the glass, both at the bottom, in terms of the depth of the piqûre, and in the angle of the cheminée, i.e. the angle at which the bowl gradually closes. A technically impeccable shape: the generosity of the "Juhlin line" enhances the virtues of champagne, while the significantly taller cheminée ensures the right distance for tasting, concentrating the aromas and fragrances of the champagne to the perfect intensity and channelling them harmoniously towards nose and mouth.

### Curva rientrante

La base della coppa ha una curva rientrante, che oltre a definirne la forma tecnica, esalta l'identità del calice e le dona quel tocco di contemporaneità imprescindibile.

**Inward Curve.** The extreme delicacy of the glass that sinuously coils towards the stem designs a light, gentle curve and gives the RJ Optimum a unique iconic identity.



RICHARD JUHLIN OPTIMUM

art. 3056

MATERIALE / MATERIAL  
Vetro cristallino /  
Crystalline glass

CAPACITÀ / CAPACITY  
290 cc / 9 3/4 oz

COLORI / COLOURS  
Clear

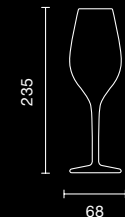



## Pua Tumbler

*Un tumbler dal design unico, allo stesso tempo dinamico e raffinato | A tumbler with a unique design, dynamic and sophisticated at the same time*

design by ITALESSE





**IT** La gamma dei bicchieri artistici di Italesse si arricchisce con il nuovo Pua, realizzato in vetro soffiato a bocca e lavorato a mano da esperti mastri vetrai. L'innovativo tocco dei pois rende questo bicchiere estremamente dinamico ed elegante, perfetto per servire acqua e altre bevande in modo brioso ma raffinato.

**EN** The new entry of the Pua, handmade of mouth-blow glass by expert glass masters, enhances Italesse's selection of artistic tumblers. The innovative detail of the polka dots makes this tumbler very elegant and dynamic, extremely suitable for serving water and other drinks with a touch of energy and style.

PUA TUMBLER

art. 3354

MATERIALE / MATERIAL  
Vetro borosilicato soffiato a bocca,  
lavorato a mano / Mouth-blown  
hand-crafted borosilicate glass

CAPACITÀ / CAPACITY  
370 cc / 12 ½ oz

COLORI / COLOURS  
Clear & White

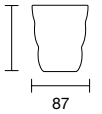

## Vertigo Tumbler

*Classe ed eleganza nella lavorazione artistica del vetro soffiato colorato / Elegance and class in the artistic craftsmanship of mouth-blown colored glass*

design by ITALESSE





**IT** Bicchieri unici e di grande raffinatezza, realizzati in vetro soffiato a bocca e lavorati a mano da esperti mastri vetrai. Un'innovativa spirale caratterizza Vertigo Tumbler con delle scanalature sia interne che esterne, impreziosendolo ulteriormente in termini di dinamicità e colorazione. Vertigo Tumbler è disponibile in più colori, con capacità 380 cc. Un bicchiere ideale per la tavola e perfetto per servire acqua e altre bevande con straordinaria eleganza.

**EN** Unique and refined drinking glasses made of mouth-blown, hand crafted glass by expert master craftsmen. An innovative spiral design characterizes the Vertigo Tumbler creating internal and external ridges that enliven the glass further with dynamism and color. Vertigo tumbler is available in various hues and has a capacity of 380 cc. This collection is ideal for sophisticated table settings and serving other beverages with extraordinary elegance.

## VERTIGO TUMBLER

art. 3353

MATERIALE / MATERIAL  
Vetro colorato soffiato a bocca e lavorato a mano / Mouth-blown, hand-crafted coloured glass

CAPACITÀ / CAPACITY  
380 cc / 12 ¾ oz

COLORI / COLOURS

Clear &amp; White



Blue &amp; White



Green &amp; White



Black &amp; White



Amber &amp; White



Red &amp; White

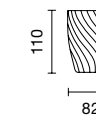



## Mares Collection

*Nata per stupire e realizzata a mano da mastri vetrai orientali, la linea Mares è composta da coloratissimi bicchieri, shot e bowl creati con una tecnica produttiva che ha radici antiche | Hand Made by oriental glassware craftsmen to astonish and surprise, the Mares Tumblers are extremely colourful glasses, shots and bowls produced using manual manufacturing techniques with ancient roots*

design by ITALESSE





**IT** La collezione Mares è nata per stupire. Realizzati a mano da mastri vetrai orientali, tumbler e shot sono creati con una tecnica produttiva che ha radici antiche. Oggetti preziosi, soffiati a bocca utilizzando melange di paste di vetro colorate, i tumbler e gli shot sono veri e propri pezzi unici (in un giorno ne vengono realizzati solo sessanta). Uno diverso dall'altro, decorano la tavola e la rendono singolare ed indimenticabile. La collezione Mares propone colori scelti pensando al mondo subacqueo delle barriere coralline, dove l'esplosione di nuances di piante e pesci tropicali ammalia e sorprende. La particolarità di questi prodotti risiede proprio nella capacità di attrarre l'attenzione: da bicchieri sanno trasformarsi in oggetti decorativi perfetti in tavola anche come ornamenti artistici.

**EN** The Mares collection is made to surprise. Hand Made by oriental glassware craftsmen, the Mares Tumblers and are produced using manual manufacturing techniques with ancient roots. The collection includes a series of tumblers and shots made of mouth-blown coloured glass paste melanges using a technique that allows for up to a maximum of only sixty pieces a day. Completely different from one another, these glasses decorate the table rendering it truly singular and unforgettable. The Mares collection proposes a series of hues that are inspired by the underwater world of coral reefs where the explosion of the nuances of coloured plants and tropical fish amaze and surprise. The uniqueness of these glasses lies in their capacity to draw attention of the onlooker, from glasses they transform themselves in decorative elements that are perfect on the table given their truly ornamental quality.



Mares Tumbler, Mares Tumbler Shot

#### MARES TUMBLER

art. 3355

MATERIALE / MATERIAL  
Pasta di vetro colorato soffiato a bocca e lavorato a mano / Hand-crafted mouth-blown colored glass paste

CAPACITÀ / CAPACITY  
310 cc / 10 ½ oz

COLORI / COLOURS

Angel Fish Tiger Fish



Star Fish



Jelly Fish



Argus Fish



Shell Fish



Oyster Fish



Tiger Fish



Napoleon Fish



Clown Fish



Parrot Fish



Sea Bass Fish



Bluefin Fish

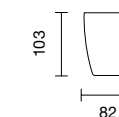

#### MARES TUMBLER SHOT

art. 3356

MATERIALE / MATERIAL  
Pasta di vetro colorato soffiato a bocca e lavorato a mano / Hand-crafted mouth-blown colored glass paste

CAPACITÀ / CAPACITY  
53 cc / 1 ¾ oz

COLORI / COLOURS

Star Fish Napoleon Fish



Clown Fish



Shell Fish



Parrot Fish



Oyster Fish

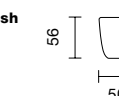

**IT** La collezione Mares si arricchisce di nuove bowl colorate e affascinanti. Le Mares Bowls sono anch'esse realizzate a mano da mastri vetrai orientali, create con una tecnica produttiva che ha radici antiche. La collezione si compone di un set di bowl più grande adatta a servire appetizers, finger food, insalate o dolci al cucchiaio e di una più piccola pensata per piccole prelibatezze, o salse e condimenti. Oggetti preziosi e divertenti, soffiati a bocca utilizzando gli stessi melange di paste di vetro colorate dei tumbler: in un giorno ne vengono realizzati solo pochi pezzi, e sono pezzi unici. Una diversa dall'altra, decorano la tavola e la rendono singolare ed indimenticabile. La collezione Mares propone colori scelti pensando al mondo subacqueo delle barriere coralline, dove l'esplosione di nuances di piante e pesci tropicali ammalia e sorprende.

**EN** The Mares collection is enriched by new colorful and fascinating bowls. Both hand made by oriental glassware craftsmen, are extremely produced using manual manufacturing techniques with ancient roots. The collection includes a series of larger bowls ideal to serve appetizers, finger food, salads or sweets and a smaller series designed for condiments or little sweets. Precious and fun, mouth-blown with the tumbler's same coloured glass paste melanges using a technique that allows only few pieces a day. Completely different from one another, these bowls decorate the table rendering it truly singular and unforgettable. The Mares collection proposes a series of hues that are inspired by the underwater world of coral reefs where the explosion of the nuances of coloured plants and tropical fish amaze and surprise



Mares Bowl N.11, Mares Bowl N.8

MARES BOWL N.11

art. 5082

MATERIALE / MATERIAL  
Pasta di vetro colorato soffiato a bocca e lavorato a mano / Hand-crafted mouth-blown colored glass paste

COLORI / COLOURS

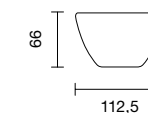

MARES BOWL N. 8

art. 5081

MATERIALE / MATERIAL  
Pasta di vetro colorato soffiato a bocca e lavorato a mano / Hand-crafted mouth-blown colored glass paste

COLORI / COLOURS

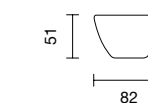



# Sfera

*Bicchieri multiuso in vetro con base in gomma colorata utile alla gestione dell'inclinazione per un servizio fantasioso / Multi-purpose glass with a colored rubber base on which to tilt the glass for a creative service*

design by MINEDIVINE



**IT** La Collezione Sfera propone un bicchiere multifunzionale di forma sferica e imboccatura ampia per distillati e liquori che permette un comodo utilizzo anche per finger food, dolci al cucchiaio e piccole prelibatezze cucinate direttamente nel forno. Sfera è dotato di una base piatta che consente di appoggiarlo con sicurezza sul piano. L'anello in gomma soffice, permette di posizionarlo secondo l'inclinazione preferita. A completare la collezione e offrire un set di servizio più completo si aggiungono altri due bicchieri di dimensioni sempre più piccole per piccoli dolci al cucchiaio, condimenti o salse.

**EN** The Sfera Collection offers a multifunctional glass with a spherical shape and a wide mouth for distillates and liqueurs, perfect also for innovative finger food presentation, desserts and small delicacies cooked directly in the oven. Sfera has a flat base so it can be placed safely on flat surfaces. Its silicone base, allows for placing of the glass at an angle as preferred. To complete the collection and offer a complete service set we include two more glasses of small dimensions for sweets, condiments or creams.

SFERA N. 11

art. 3330

MATERIALE / MATERIAL  
Vetro borosilicato soffiato a bocca, lavorato a mano e gomma soffice colorata base / Mouth-blown hand-crafted borosilicate glass and soft-coloured rubber base

CAPACITÀ / CAPACITY  
580 cc / 19 ¾ oz

COLORI / COLOURS  
Clear



BASE: White



SFERA N. 9

art. 3333

MATERIALE / MATERIAL  
Vetro borosilicato soffiato a bocca, lavorato a mano e gomma soffice colorata base / Mouth-blown hand-crafted borosilicate glass and soft-coloured rubber base

CAPACITÀ / CAPACITY  
295 cc / 10 oz

COLORI / COLOURS  
Clear



SFERA N. 7

art. 3332

MATERIALE / MATERIAL  
Vetro borosilicato soffiato a bocca, lavorato a mano / Mouth-blown hand-crafted borosilicate glass

CAPACITÀ / CAPACITY  
120 cc / 4 oz

COLORI / COLOURS  
Clear

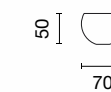

SFERA N. 5

art. 3331

MATERIALE / MATERIAL  
Vetro borosilicato soffiato a bocca, lavorato a mano / Mouth-blown hand-crafted borosilicate glass

CAPACITÀ / CAPACITY  
70 cc / 2 ¼ oz

COLORI / COLOURS  
Clear

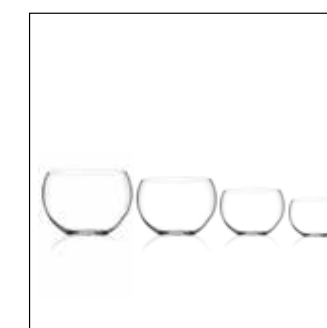
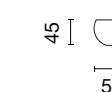

Sfera Collection



## Bolle Tumbler & Bolle Pitcher

*Prodotti in pasta di vetro colorata, Bolle Tumbler e Bolle Pitcher sono caratterizzati da un design sinuoso e da vivaci giochi di luce / Made of coloured glass paste, Bolle Tumbler and Bolle Pitcher are characterized by a sinuous design that creates lively plays of light*

design by LUCA TRAZZI





**IT** Innovativi, dal design sinuoso e proposti in sei nuances, i Bolle Tumbler si prestano ad interpretare le tavole più diverse: rigorose, colorate, ricche o minimali. Versatilità e maneggevolezza fanno di questi bicchieri la scelta ideale per servire qualsiasi bevanda, dall'acqua a freschi succhi di frutta, da long drink a cocktail colorati. La Bolle Pitcher è un caraffa originale, ideale per servire soft drink, succhi di frutta, cocktail e aperitivi.

**EN** Innovative, sinuous in its design and available in six hues, the Bolle Tumbler is apt for interpreting the most diverse tables: elegant, colorful, richly decorated as well as minimalist. Versatility and easy handling make these tumblers the ideal choice for serving everything from water, fresh fruit juices to long drinks and colorful cocktails. The Bolle Pitcher is an original carafe ideal for serving soft drinks, juices, cocktails and fresh drinks.

## BOLLE TUMBLER

art. 3350

MATERIALE / MATERIAL  
Vetro colorato lavorato a mano /  
Colored hand-crafted glass

CAPACITÀ / CAPACITY  
340 cc / 12 ¾ oz

COLORI / COLOURS  
Clear Black Transp.



Red



Orange



Blue



105

90

## BOLLE PITCHER

art. 1410

MATERIALE / MATERIAL  
Vetro lavorato a mano /  
Hand-crafted glass

CAPACITÀ / CAPACITY  
1200 cc / 40 ½ oz

COLORI / COLOURS  
Clear



117



217

170



## Wormwood Collection

*Italesse presenta una delle collezioni cocktail più celebri e apprezzate al mondo, in grado di fondere un accattivante design in un prodotto tecnico e innovativo dedicato ai Bartender professionisti, ai Cocktail Bar premium e al mondo dell'Ospitalità | Italesse presents one of the world's most renowned and appreciated cocktail collections that combine appealing design with highly technical and innovative product concepts. Dedicated to cocktail professionals, premium bars, and the hospitality world*

design by LUCA TRAZZI  
concept by GIANCARLO MANCINO



**IT** Con Wormwood Italesse propone ai professionisti una linea cocktail e una proposta tavola in sintonia con i trend attuali ed in particolare con il revival ispirato alla Belle Epoque. Partendo dal minimalismo del nuovo millennio, i bartender guardano oggi al futuro ricercando atmosfere art decò, evolvendo in chiave contemporanea il glamour d'inizio novecento. In linea con la mission di Italesse, la linea Wormwood è la sintesi tra un oggetto emozionale con un design forte e un prodotto tecnico. Wormwood è il risultato della collaborazione con uno dei più noti opinion leader del settore cocktail, Giancarlo Mancino e con il designer Luca Trazzi: due personalità forti, che hanno saputo unire un'estetica ricercata a un design in grado di valorizzare le creazioni cocktail. Italesse ha sintetizzato il lavoro in una collezione cocktail che anticipa i trend, proponendo ai professionisti prodotti tecnicamente evoluti capaci di attirare l'attenzione con il proprio fascino.

**EN** Italesse offers cocktail professionals a cocktail and dining collection in harmony with current trends that echo the revival of the roaring twenties. Leaving behind the minimalism that has characterized the beginning of the new millennium, today professionals in the cocktail field tend to favor warmer art deco settings, reinterpreting Belle Epoque elements with a markedly contemporary touch. In line with Italesse's mission, the Wormwood collection is the synthesis of a strong, emotional design and a fundamentally technical product. Wormwood is the result of the collaboration between one of the most distinguished opinion leaders of the cocktail world, Giancarlo Mancino and the renowned designer Luca Trazzi. These two strong personalities have ingeniously combined an intricate aesthetic with a design that elevates mixed drink creations. Italesse seamlessly marries the work of two key experts in a collection that anticipates trends and offers technically evolved products that catch the eye with their unique charm.





**IT** La collezione Wormwood si compone di sette calici e bicchieri pensati per il mondo dei grandi cocktail bar e la degustazione che garantisce un servizio originale ed elegante, dall'atmosfera retro pur con linee contemporanee. Completa la collezione il Gallone, un grande bicchiere a tulipano utilizzato dai barman per preparare interi cocktail miscelati, o più porzioni dello stesso cocktail contemporaneamente. Italesse ha scelto di arricchire tutti gli elementi della collezione Wormwood con un decoro inciso che richiama la pianta (artemisia) di assenzio. Volute di rami e foglie valorizzano le forme, creando un'ambientazione che sa essere contemporanea e di grande effetto, rendendo unica la presentazione dei cocktail.

**EN** The Wormwood collection is composed of seven glasses and stem glasses conceived for the world of grand cocktail bars and tasting that guarantees an innovative and elegant service that has retro feel yet is contemporary in its forms. The Gallone completes the classic cocktail collection, a large tulip-shaped mixing glass used by bartenders to mix cocktails or to make more than one serving of the same drink at a time. Italesse has embellished the collection with a decorative pattern, an ethereal engraving whose motif features the absinthe (wormwood) plant. Spiraling branches and leaves heighten the glassware's forms, contemporary and highly effective, rendering cocktail presentation truly original.



## WORMWOOD GALLONE

art. 1404

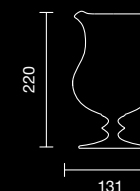
MATERIALE / MATERIAL  
Vetro soffiato a bocca /  
Mouth-blown glassCAPACITÀ / CAPACITY  
1000 cc / 33 ¾ ozCOLORI / COLOURS  
Clear Pattern

## WORMWOOD ALTO-BALL

art. 3352

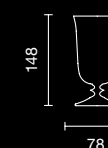
MATERIALE / MATERIAL  
Vetro cristallino /  
Crystalline glassCAPACITÀ / CAPACITY  
310 cc / 10 ½ ozCOLORI / COLOURS  
Clear Pattern

## WORMWOOD DOUBLE PRESIDENTE

art. 3372

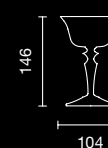
MATERIALE / MATERIAL  
Vetro cristallino /  
Crystalline glassCAPACITÀ / CAPACITY  
220 cc / 7 ½ ozCOLORI / COLOURS  
Clear Pattern

## WORMWOOD GALANTE

art. 3349

MATERIALE / MATERIAL  
Vetro cristallino /  
Crystalline glassCAPACITÀ / CAPACITY  
490 cc / 16 ½ ozCOLORI / COLOURS  
Clear Pattern

## WORMWOOD ASTORIA

art. 3371

MATERIALE / MATERIAL  
Vetro cristallino /  
Crystalline glassCAPACITÀ / CAPACITY  
130 cc / 4 ½ ozCOLORI / COLOURS  
Clear Pattern

## WORMWOOD PRESIDENTE

art. 3370

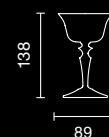
MATERIALE / MATERIAL  
Vetro cristallino /  
Crystalline glassCAPACITÀ / CAPACITY  
135 cc / 4 ½ ozCOLORI / COLOURS  
Clear Pattern

## WORMWOOD ROCK-GOBBLER

art. 3351

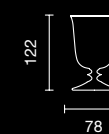
MATERIALE / MATERIAL  
Vetro cristallino /  
Crystalline glassCAPACITÀ / CAPACITY  
230 cc / 7 ¾ ozCOLORI / COLOURS  
Clear Pattern

## WORMWOOD FIZZ

art. 3038

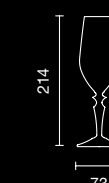
MATERIALE / MATERIAL  
Vetro cristallino /  
Crystalline glassCAPACITÀ / CAPACITY  
260 cc / 8 ¾ ozCOLORI / COLOURS  
Pattern

## Tiburón Collection

*Una linea di calici e bicchieri creati per la degustazione professionale, caratterizzata da linee aggressive ed eleganti |  
A line of wineglasses and tumblers for professional tasting, characterised by aggressive yet elegant forms*

design by ITALESSE





**IT** La linea Tiburón, collezione che deve l'ispirazione delle sue curve ardite ed aggressive alla forma di un potente squalo, è formata da pregiati calici e bicchieri. I calici della collezione presentano una piquère dalla linea profonda e tagliente concepita per percepire la reale colorazione del vino, mentre la coppa ne esalta la massa. La sciancratura della parte bassa della coppa permette, inoltre, che il vino si sviluppi nella parte superiore, favorendone l'ossigenazione. Realizzati con la tecnologia brevettata Xtreme® e grazie ai contorni angolati, questi calici risultano altamente resistenti. La collezione si completa con i Tiburón Bar e Tumbler per servire acqua, birre e cocktail.

**EN** The Tiburón collection of stemware and tumblers stands out in the crowd with its bold and aggressive shapes inspired by the great shark. The stem glasses in this collection feature a deep-piquère highlighting wine's true color, while the wide bowl enhances the wine's body. The large width of the bowl allows the wine to develop the top portion of the glass, elevating oxygenation levels. Made with Italesse's patented Xtreme® technology, the angled contours of the stemware reinforce the resistance of the glass against breakage. Possessing the same Xtreme® technology, the Tiburón Bar, and the Tiburón Tumbler complete the collection and are perfect for serving water, selected beers, or cocktails.



## TIBURÓN LARGE

art. 3340

MATERIALE / MATERIAL  
Vetro cristallino Xtreme® soffiato in automatico in assenza di piombo / Xtreme crystalline® automatic blown glass with no lead

CAPACITÀ / CAPACITY  
620 cc / 21 oz

COLORI / COLOURS  
Clear



## TIBURÓN MEDIUM

art. 3341

MATERIALE / MATERIAL  
Vetro cristallino Xtreme® soffiato in automatico in assenza di piombo / Xtreme crystalline® automatic blown glass with no lead

CAPACITÀ / CAPACITY  
500 cc / 16 2/3 oz

COLORI / COLOURS  
Clear

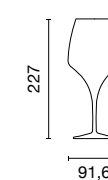

## TIBURÓN GRAN CRU

art. 3053

MATERIALE / MATERIAL  
Vetro cristallino Xtreme® soffiato in automatico in assenza di piombo / Xtreme crystalline® automatic blown glass with no lead

CAPACITÀ / CAPACITY  
380 cc / 12 3/4 oz

COLORI / COLOURS  
Clear

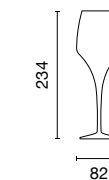

## TIBURÓN TUMBLER

art. 3342

MATERIALE / MATERIAL  
Vetro colorato soffiato a bocca e lavorato a mano / Mouth-blown, hand-crafted coloured glass

CAPACITÀ / CAPACITY  
350 cc / 11 3/4 oz

COLORI / COLOURS

White Black Transp.



Red

Violet



Blue

Orange

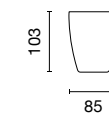



## Vertical Collection

*Una linea di calici e tumbler tecnici e polifunzionali,  
adatti a tutte le tavole | A technical and multifunctional  
glassware range, suited to every table*



**IT** Vertical è la collezione di calici e tumbler in vetro cristallino Xtreme® dall'eleganza raffinata e dalle caratteristiche altamente tecniche. La linea è formata da calici vino e flûte pensati per la degustazione di grandi vini. I calici sono dotati di una profonda piqûre per favorire il perlage e grazie all'accurato design, risultano adatti a molteplici utilizzi. I calici Vertical sono realizzati con tecnologia Xtreme®, caratteristica che rende la collezione altamente resistente e quindi adatta ad ogni ambiente e situazione, anche le più "estreme", per aperitivi, cene e feste all'insegna dello stile e della sicurezza. Vertical si completa con un tumbler polifunzionale, perfetto per servire acqua, soft drink e colorati cocktail.

**EN** Vertical is a collection of refined and elegant crystalline Xtreme® glasses with highly technical features. The line consists of wine glasses and flutes for serving and tasting of fine wines. The wine glasses of the Vertical Collection feature a special piqûre that enhances perlage and their carefully studied design renders them suitable for multiple applications. Produced using Xtreme® technology glass, optimum performance and high resistance to breakage is guaranteed with this glassware range, making this collection particularly suitable for all environments and settings, including "extreme" situations: apéritifs, cocktail parties and dinners to be enjoyed in style and absolute safety. The Vertical Line is completed by a multifunctional tumbler perfect for serving water, soft-drinks and colorful cocktails.



## VERTICAL LARGE

art. 3304

MATERIALE / MATERIAL  
Vetro cristallino Xtreme® soffiato in automatico in assenza di piombo / Xtreme® Crystalline automatic blown glass with no lead

CAPACITÀ / CAPACITY  
500 cc / 16 ¾ oz

COLORI / COLOURS  
Clear

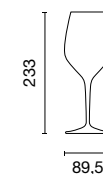

## VERTICAL MEDIUM

art. 3308

MATERIALE / MATERIAL  
Vetro cristallino Xtreme® soffiato in automatico in assenza di piombo / Xtreme® Crystalline automatic blown glass with no lead

CAPACITÀ / CAPACITY  
390 cc / 13 oz

COLORI / COLOURS  
Clear



## PRIVÉ GRAN CRU

art. 3049

MATERIALE / MATERIAL  
Vetro cristallino Xtreme® soffiato in automatico in assenza di piombo / Xtreme® Crystalline automatic blown glass with no lead

CAPACITÀ / CAPACITY  
330 cc / 11 oz

COLORI / COLOURS  
Clear

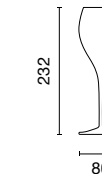

## PRIVÉ FLÛTE

art. 3048

MATERIALE / MATERIAL  
Vetro cristallino Xtreme® soffiato in automatico in assenza di piombo / Xtreme® Crystalline automatic blown glass with no lead

CAPACITÀ / CAPACITY  
150 cc / 5 oz

COLORI / COLOURS  
Clear



## MASTER

art. 3309

MATERIALE / MATERIAL  
Vetro / Glass

CAPACITÀ / CAPACITY  
290 cc / 9 ¾ oz

COLORI / COLOURS  
Clear

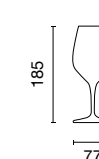

## VERTICAL PARTY

art. 3310

MATERIALE / MATERIAL  
Vetro cristallino soffiato in automatico in assenza di piombo / Crystalline automatic blown glass with no lead

CAPACITÀ / CAPACITY  
420 cc / 14 ¼ oz

COLORI / COLOURS  
Clear White

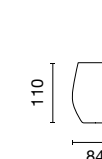

# Bora Collection

*La linea Bora è una collezione di calici polifunzionali dalle linee essenziali e performance avanzate | The Bora Line is a range of multifunctional stemglasses characterized by advanced performance and essential lines*

design by ITALESSE



**IT** Una linea di tre calici, il Medium, il Large e la Flûte, che si contraddistingue per robustezza, grazie alla tecnologia pull-stem. Il bevante sottile di questi calici ottenuto dal taglio a laser, garantisce una nuova esperienza della degustazione, più piacevole e più raffinata, e che rende la linea Bora adatta per tutti i tipi di vini.

**EN** A line of stem glasses consisting of three elements, Bora Medium, Bora Large and Bora Flute, distinguished by robustness thanks to the pull-stem technology used to make them. Bora's delicate, laser-cut rim heightens the tasting experience rendering it more enjoyable and sophisticated, making it suitable for serving all types of wine.

## BORA LARGE

art. 3323

MATERIALE / MATERIAL  
Vetro / Glass

CAPACITÀ / CAPACITY  
500 cc / 16 ¾ oz

COLORI / COLOURS  
Clear



## BORA MEDIUM

art. 3324

MATERIALE / MATERIAL  
Vetro / Glass

CAPACITÀ / CAPACITY  
390 cc / 13 oz

COLORI / COLOURS  
Clear

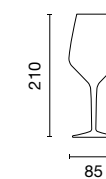

## BORA FLÛTE

art. 3054

MATERIALE / MATERIAL  
Vetro / Glass

CAPACITÀ / CAPACITY  
280 cc / 9 ½ oz

COLORI / COLOURS  
Clear





## Easy Collection

*Calici da vino dalle linee semplici ed armoniose ma con valenze tecnicamente performanti, perfetti per la degustazione professionale / Wine stemware line with simple proportions and shapes that deliver high performance, ideal for professional tasting*

design by ITALESSE

**IT** I calici della linea Easy sono convenienti e performanti e si declinano in diverse capacità. Un calice maxi, Easy Big, per grandi vini invecchiati che necessitano di particolare ossigenazione, un bicchiere per il vino di formato large, Easy Large, per degustazioni di qualsiasi tipo di vino o aperitivo. La sua versione più alta Easy Large Plus calice dalle forme semplici e armoniose con gambo sottile e allungato adatto a servire vini giovani e freschi. Completa la collezione un calice per il vino di formato medio, Easy Medium, dalle dimensioni più ridotte, per degustare vini più freschi e giovani.

**EN** The Easy line is composed of convenient and high performance wine stem glasses. The larger format glass, Easy Big, for great aged wines that require special oxygenation; a large stem glass for tasting all types of wines or cocktails and the new stem glass higher and suitable for young and fresh wines; a medium white wine stem glass, of a smaller size, for younger and fresh wines.



### EASY BIG

art. 3322

MATERIALE / MATERIAL  
Vetro / Glass

CAPACITÀ / CAPACITY  
760 cc / 25 ¾ oz

COLORI / COLOURS  
Clear

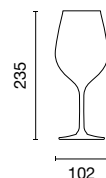

### EASY LARGE PLUS

art. 3368

MATERIALE / MATERIAL  
Vetro / Glass

CAPACITÀ / CAPACITY  
500 cc / 16 ¾ oz

COLORI / COLOURS  
Clear

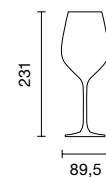

### EASY LARGE

art. 3321

MATERIALE / MATERIAL  
Vetro / Glass

CAPACITÀ / CAPACITY  
500 cc / 16 ¾ oz

COLORI / COLOURS  
Clear



### EASY MEDIUM

art. 3320

MATERIALE / MATERIAL  
Vetro / Glass

CAPACITÀ / CAPACITY  
380 cc / 12 ¾ oz

COLORI / COLOURS  
Clear



## Dolcevita & Mastro

*Due calici adatti al servizio professionale, ideali per le situazioni e gli ambienti del mondo del vino e della birra che richiedono particolare resistenza / Two stem glasses apt for professional service, ideal for serving wine and beer in all those situations and environments that require high resistance*

design by ITALESSE

**IT** Il calice polifunzionale Dolcevita, presenta linee pulite e semplici ed è dotato di particolare robustezza per offrire ottime performance di servizio. È perfetto per degustare tutti i tipi di vino, ma anche per servire aperitivi in modo originale e con stile. Mastro è un calice universale in vetro per la degustazione della birra. Ideato per esaltare la schiuma, il gusto e consentire il pieno sviluppo degli aromi della birra. Resistente, è perfetto per l'utilizzo professionale.

**EN** Dolcevita multifunctional stem glass with clean and linear forms is particularly robust to offer excellent service performance. It is ideal for serving all type of wines as well as original aperitifs with style. Mastro is a universal stemware for beer tasting. Designed for enhancing the foam and the taste, it allows the correct development of beer's aromas. Resistant, it is perfect for the professional use.



### DOLCEVITA

art. 3374

MATERIALE / MATERIAL  
Vetro / Glass

CAPACITÀ / CAPACITY  
470 cc / 15 ¾ oz

COLORI / COLOURS  
Clear

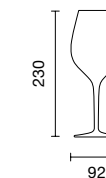

### MASTRO

art. 3369

MATERIALE / MATERIAL  
Vetro / Glass

CAPACITÀ / CAPACITY  
420 cc / 14 ¼ oz

COLORI / COLOURS  
Clear



## Riviera & Flûte N°5

*Riviera & Flûte N°5 entrano a far parte della collezione flûte Italesse, ambendo a diventare nuove icone per piccoli e grandi produttori di spumanti e Champagne, che fin da subito ne apprezzeranno la forma raffinata e l'elevata prestazione tecnica | Riviera & Flûte N°5 join Italesse's flute collection with the objective of becoming flutes of reference for small and large producers of sparkling wines and Champagne that will appreciate their sophisticated forms and their technical performance*

design by ITALESSE



**IT** Riviera è una flûte da degustazione per Champagne e vini frizzanti, moderna, resistente e dalla forte personalità. Gambo slanciato e punto perlage inciso a laser in una profonda piquère, la rendono una flûte distintiva. Ideale in una degustazione professionale, è declinato in tre capacità, risultando il calice ideale per ogni esigenza di servizio. Il modello da 14 cl, in particolare, ben si presta a servire vini dolci, grappe, distillati d'uva e liquori. Capacità superiori per Flûte N°5, flûte professionale da degustazione dal design pulito e minimale con coppa stretta e gambo sottile ma molto resistente, da 28 cc.

**EN** Riviera is a tasting flute for Champagnes and sparkling wines, modern, resistant and with strong personality. A slender stem and a laser-made perlage point in its deep piqueure make this a distinctive flute. Ideal for professional tasting, it is available in three different volumes, that makes it the ideal flute for all service needs. The 14 cl model is also well-adapted for the service of sweet wines, digestifs and liqueurs. Flûte N°5 with a capacity of 28 cc, is a flûte for professional tasting with a clean and minimal design a narrow bowl and a thin, yet very strong stem.



### FLÛTE N°5

art. 3059

MATERIALE / MATERIAL  
Vetro cristallino Xtreme® soffiato in automatico in assenza di piombo / Xtreme® Crystalline automatic blown glass with no lead

CAPACITÀ / CAPACITY  
280 cc / 9 ½ oz

COLORI / COLOURS  
Clear



### RIVIERA 17

art. 3070

MATERIALE / MATERIAL  
Vetro / Glass

CAPACITÀ / CAPACITY  
170 cc / 5 ¾ oz

COLORI / COLOURS  
Clear



### RIVIERA 16

art. 3069

MATERIALE / MATERIAL  
Vetro / Glass

CAPACITÀ / CAPACITY  
160 cc / 5 ½ oz

COLORI / COLOURS  
Clear

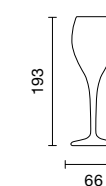

### RIVIERA 14

art. 3068

MATERIALE / MATERIAL  
Vetro / Glass

CAPACITÀ / CAPACITY  
140 cc / 4 ¾ oz

COLORI / COLOURS  
Clear

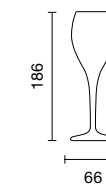



# Dixie Tumbler

*Forme dinamiche e performance di servizio ottimali per la serie Dixie Tumbler in vetro pressato | Dynamic forms for strong performance in service, the Dixie Tumbler series in pressed glass*

design by ITALESSE



**IT** Dixie Tumbler, un bicchiere in vetro pressato trasparente impreziosito da un motivo decorativo in grado di conferire grande luminosità. Disponibile in due formati, dal più capiente Dixie Tumbler di 360 cc al Dixie Tumbler Small con capacità 310 cc. Una straordinaria robustezza assieme all'impilabilità caratterizzano le alte performance nel servizio della collezione. Dixie Tumbler è una scelta ottimale per servire i più svariati tipi di bevande, dai succhi di frutta ai cocktail.

**EN** Dixie Tumbler, a tumbler in transparent pressed glass is embellished by a decorative motif that gives it intense luminosity. It is available in two different formats, the larger Dixie Tumbler with a capacity of 360 cc and the Dixie Tumbler Small that is 310 cc. An extraordinary robustness together with stackability, assures the strong performance of the collection. Dixie Tumbler is an ideal choice for a wide range of drinks, from juice to cocktails.

DIXIE TUMBLER

art. 0038

MATERIALE / MATERIAL  
Vetro / Glass

CAPACITÀ / CAPACITY  
360 cc / 12 oz

COLORI / COLOURS  
Clear

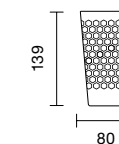

DIXIE TUMBLER SMALL

art. 0039

MATERIALE / MATERIAL  
Vetro / Glass

CAPACITÀ / CAPACITY  
310 cc / 10 1/2 oz

COLORI / COLOURS  
Clear

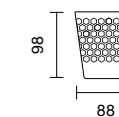

## Tonic Glass

*Bicchieri impilabili di vetro dalla linea conica, delicata quanto marcatamente definita, adatti in qualsiasi situazione / Conical Tonic Glass tumbler with a delicate and clearly defined design, an ideal choice in all situations*

design by CLAESSION KOIVISTO RUNE



**IT** L'eleganza e la semplicità rendono i bicchieri impilabili Tonic Glass adatti a qualsiasi situazione: una tavola raffinata, un aperitivo informale o proposto più semplicemente da solo. I Tonic Glass sono bicchieri impilabili multifunzionali, adatti a servire tutti i tipi di bevande, dall'acqua ai soft e long drink, dalla birra ai più elaborati cocktail. Tonic Glass Small è la versione piccola di Tonic Glass. Pensato per servire l'acqua in un bicchiere dalle dimensioni contenute, si distingue per fondi stonati e bevante sottile: bicchiere minimal ma di grande carattere. I dettagli tecnici ne fanno il bicchiere ideale per servire anche liquori e distillati e suggeriscono un nuovo modo di gustare il vino, decisamente più contemporaneo.

**EN** The elegance and simplicity of conical Tonic Glass make it the ideal choice for all situations: a refined table, an informal aperitif or presented alone in all its deliberate simplicity. Stackable and multifunctional, Tonic Glass is ideal for serving all types of drinks, ranging from water to soft and long drinks, beer and elaborate cocktails. Tonic Glass Small is the small version of Tonic Glass. Designed to serve water in a glass of a smaller size, it is characterized by a rounded base and a delicate rim making it minimal yet full of character. The technical details make it the ideal glass for serving liqueurs and spirits, as well as a contemporary and suggestive way to enjoy wine.

TONIC GLASS

art. 3318

MATERIALE / MATERIAL  
Vetro / Glass

CAPACITÀ / CAPACITY  
400 cc / 13 ½ oz

COLORI / COLOURS  
Clear

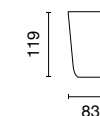

TONIC GLASS SMALL

art. 3317

MATERIALE / MATERIAL  
Vetro / Glass

CAPACITÀ / CAPACITY  
290 cc / 9 ¾ oz

COLORI / COLOURS  
Clear

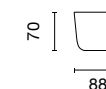



## Go Go

*Bicchieri da liquore e distillati caratterizzati da coppe ampie che amplificano le potenzialità degustative, disponibili in due varianti | Liqueur and spirits glasses characterized by wide bowls that heighten the tasting experience, available in two variations*

design by ITALESSE

**IT** La sinuosità delle linee di Go-Go, tumbler dalle proporzioni e dalla capacità generosa, ritrova gli stessi equilibri anche nella versione small. Capaci di esaltare i profumi del distillato e di far percepire profondamente gli aromi grazie all'ampia coppa che ne amplifica e sprigiona le potenzialità degustative. Nati per degustare anche liquori dolci, limoncelli e amari, entrambi i calici presentano una capacità di 4 cl nella base.

**EN** The sinuosity of Go-Go, a large-sized tumbler, is also balanced in its small version. Capable to enhance the flavor of distillates and to help aromas be fully perceived thanks to its large cup, which amplifies and enhances tastes. The capacity of the base of both glasses, which have been designed to also taste sweet liquors, limoncello and bitters, is 4 cl.

GO-GO

art. 3319

MATERIALE / MATERIAL  
Vetro cristallino soffiato in automatico  
in assenza di piombo / Crystalline  
automatic blown glass with no lead

CAPACITÀ / CAPACITY  
580 cc / 19 3/4 oz

COLORI / COLOURS  
Clear

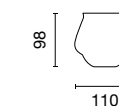

GO-GO SMALL

art. 3328

MATERIALE / MATERIAL  
Vetro cristallino soffiato in automatico  
in assenza di piombo / Crystalline  
automatic blown glass with no lead

CAPACITÀ / CAPACITY  
320 cc / 320 3/4 oz

COLORI / COLOURS  
Clear

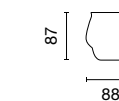

## Premium Collection

*Bicchieri polifunzionali in vetro cristallino perfetti per il mondo mixology | Multifunctional glasses made of crystalline glass, perfect for the world of mixology world*

design by ITALESSE

**IT** La linea premium di Italesse è specificamente studiata per soddisfare tutte le esigenze di servizio legate al mondo mixology: long e soft drinks, cocktails, whisky, martini etc. e diventano l'assortimento perfetto per i contesti bar e ristorante. Profili morbidi e trasparenza di luce grazie al materiale vetro cristallino per una linea sobria e raffinata formata da due tumbler bassi, due tumbler allungati, una coppa martini e un mini tumbler shot. Questi prodotti sono attentamente studiati nelle capacità e altamente polifunzionali. Dotati di un fondo spesso che garantisce la massima resistenza ed eleganza.

**EN** Italesse premium line is specifically designed to meet all service requirements linked to the mixology world: long and soft drinks, cocktails, whiskeys, martinis. They are the perfect range for bars / restaurants. Soft shapes and brilliance thanks to the crystal clear glass for a sober and refined line consisting of two low tumblers, two tall tumblers, a martini glass and a mini tumbler shot. The capacity of these items is carefully studied and multifunctional. They come with a thick base, which guarantees top resistance and elegance.



### PREMIUM MARTINI

art. 0034

MATERIALE / MATERIAL  
Vetro cristallino soffiato in automatico  
in assenza di piombo / Crystalline  
automatic blown glass with no lead

CAPACITÀ / CAPACITY  
240 cc / 8 oz

COLORI / COLOURS  
Clear

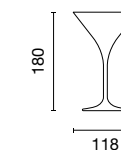

### PREMIUM TUMBLER

art. 0025

MATERIALE / MATERIAL  
Vetro cristallino soffiato in automatico  
in assenza di piombo / Crystalline  
automatic blown glass with no lead

CAPACITÀ / CAPACITY  
345 cc / 11 ¾ oz

COLORI / COLOURS  
Clear

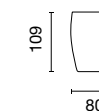

### PREMIUM HI-BALL

art. 0032

MATERIALE / MATERIAL  
Vetro cristallino soffiato in automatico  
in assenza di piombo / Crystalline  
automatic blown glass with no lead

CAPACITÀ / CAPACITY  
310 cc / 10 ½ oz

COLORI / COLOURS  
Clear

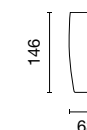

### PREMIUM TUMBLER LARGE

art. 0030

MATERIALE / MATERIAL  
Vetro cristallino soffiato in automatico  
in assenza di piombo / Crystalline  
automatic blown glass with no lead

CAPACITÀ / CAPACITY  
465 cc / 15 ¾ oz

COLORI / COLOURS  
Clear

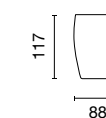

### PREMIUM HI-BALL LARGE

art. 0033

MATERIALE / MATERIAL  
Vetro cristallino soffiato in automatico  
in assenza di piombo / Crystalline  
automatic blown glass with no lead

CAPACITÀ / CAPACITY  
435 cc / 14 ¾ oz

COLORI / COLOURS  
Clear

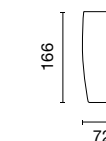

### PREMIUM SHOT

art. 0031

MATERIALE / MATERIAL  
Vetro cristallino soffiato in automatico  
in assenza di piombo / Crystalline  
automatic blown glass with no lead

CAPACITÀ / CAPACITY  
72 cc / 2 ½ oz

COLORI / COLOURS  
Clear

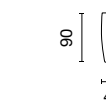



## Beach Collection

*Una proposta di calici e bicchieri perfetti in ambienti outdoor per un servizio glamour in piena sicurezza | A collection of stemware and tumblers perfect for outdoor environments, for glamorous service in complete safety*

design by ITALESSE





**IT** Funzionale, infrangibile, divertente, la linea Beach ripropone i calici, le flûte, i tumbler Italesse in versione outdoor, pratici e sicuri perché assolutamente indistruttibili. Perfetti per il mondo outdoor (piscine, spiagge, club), la linea è realizzata in materiali plastici nobili declinati in un'ampia gamma di prodotti, dal tumbler per acqua e soft drink, al calice per vini bianchi e rossi, dal flûte da champagne alla più glamour coppa martini.

**EN** Functional, unbreakable, fun, the Beach line proposes Italesse stem glasses, flutes, tumblers in their practical and safe thanks to their unbreakable qualities. Perfect for outdoor settings (pools, spas, beaches, clubs), the line is made of premium quality plastic materials for a wide range of products, from the tumbler for water and soft-drinks, the stem glass for red and white wines to the champagne flute and the glamorous Martini glass.



## MARTINI BEACH

art. 3945

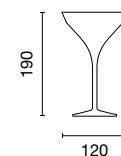
MATERIALE / MATERIAL  
**Policrystal®**CAPACITÀ / CAPACITY  
**270 cc / 9 oz**COLORI / COLOURS  
**Clear**

## VERTICAL BEACH

art. 3930

MATERIALE / MATERIAL  
**Policrystal®**CAPACITÀ / CAPACITY  
**330 cc / 11 oz**COLORI / COLOURS  
**Clear**

## PRIVÉ BEACH

art. 3920

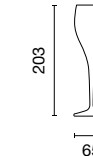
MATERIALE / MATERIAL  
**SAN / Policrystal®**CAPACITÀ / CAPACITY  
**130 cc / 4 1/4 oz**COLORI / COLOURS  
**Clear White**

## BREW BEACH 40

art. 3917

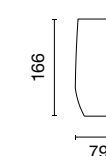
MATERIALE / MATERIAL  
**Policrystal®**CAPACITÀ / CAPACITY  
**500 cc / 17 oz**COLORI / COLOURS  
**Clear**

## BREW BEACH 33

art. 3916

MATERIALE / MATERIAL  
**Policrystal®**CAPACITÀ / CAPACITY  
**450 cc / 15 1/4 oz**COLORI / COLOURS  
**Clear**

## VERTICAL PARTY BEACH

art. 3935

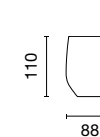
MATERIALE / MATERIAL  
**Policrystal®**CAPACITÀ / CAPACITY  
**420 cc / 14 1/4 oz**COLORI / COLOURS  
**Clear White****Red****Blue**

## MOONLIGHT BEACH

art. 3931

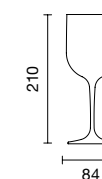
MATERIALE / MATERIAL  
**SAN / Policrystal®**CAPACITÀ / CAPACITY  
**410 cc / 13 1/4 oz**COLORI / COLOURS  
**Clear White**

## SUNLIGHT BEACH

art. 3922

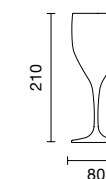
MATERIALE / MATERIAL  
**SAN / Policrystal®**CAPACITÀ / CAPACITY  
**330 cc / 11 1/4 oz**COLORI / COLOURS  
**Clear White**



## Air Beach Collection

*Calici realizzati in materiale plastico Tritan™, ideali per servire vini e aperitivi in ambienti outdoor | Plastic glasses made in Tritan™ ideal for tasting wine and aperitifs outdoor*

design by ITALESSE

**IT** Dalle forme pure e classiche, questa linea di calici in materiale plastico Tritan™ è composta dai modelli Air Beach G&T, Air Beach Wine, Air Beach Flute 20; è estremamente versatile e indicata per il servizio professionale. La tecnica di soffiatura permette una fedele emulazione delle forme tradizionali dei calici da vino in vetro. Gli spessori sono meno importanti, il che li rende leggerissimi e maneggevoli al tatto. Gli Air Beach sono ideali per una degustazione o grande manifestazione outdoor, per i locali sulle spiagge e con spazi all'aperto, gli hotel con servizio bar in piscina o in spiaggia. Tutti momenti e luoghi dove l'impiego del vetro può risultare poco sicuro.

**EN** Classical, pure forms that carry the essence of traditional glasses this Tritan™ plastic stemware is highly versatile. Composed of the models Air Beach G&T, Air Beach Wine and Air Beach Flute 20; this collection lends itself perfectly to professional service. Made using machine blown techniques this stemware is extraordinarily light rendering it incredibly elegant and easy-to-handle and with optimum transparency. The Air Beach is a perfect addition to any outdoor tasting or exhibition, beach and pool service and for al fresco dining, all situations in which the use of glass would be unsafe.



### AIR BEACH G&T

art. 0048

MATERIALE / MATERIAL  
Tritan™ soffiato in automatico /  
Automatic blown Tritan™

CAPACITÀ / CAPACITY  
700 cc / 23 ¾ oz

COLORI / COLOURS  
Clear

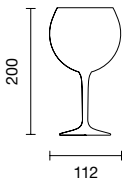

### AIR BEACH WINE

art. 0050

MATERIALE / MATERIAL  
Tritan™ soffiato in automatico /  
Automatic blown Tritan™

CAPACITÀ / CAPACITY  
475 cc / 16 oz

COLORI / COLOURS  
Clear

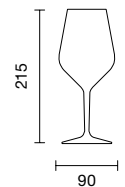

### AIR BEACH FLÛTE 20

art. 0063

MATERIALE / MATERIAL  
Tritan™ soffiato in automatico /  
Automatic blown Tritan™

CAPACITÀ / CAPACITY  
200 cc / 6 ¾ oz

COLORI / COLOURS  
Clear

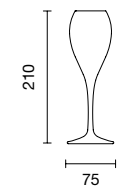

## Bolle Beach Tumbler

*Un bicchiere in policarbonato con una superficie ricca di bolle in rilievo, Bolle Beach Tumbler dona un tocco vivace e divertente alla collezione | A polycarbonate glass with a surface with embossed bubbles Bolle Beach Tumbler gives the collection a fun and lively touch*

design by LUCA TRAZZI



**IT** Un design emozionale ed originale caratterizza questo bicchiere. Adatto a servire acqua, freschi succhi di frutta o aperitivi alcolici, Bolle Beach Tumbler è ideale per essere utilizzato in ambienti professionali in quanto funzionale, impilabile e resistente nel servizio e si inserisce perfettamente anche in moderni ambienti casa sia indoor che outdoor.

**EN** An original and emotional design characterizes this tumbler. Suitable for serving water, fresh fruit juices or alcohol based drinks, Bolle Beach Tumbler is ideal in professional environments for its functionality, stackability and durability yet lends itself perfectly to use in the modern home, both indoors and outdoors.



BOLLE BEACH TUMBLER

art. 3941

MATERIALE / MATERIAL  
**Policrystal®**

CAPACITÀ / CAPACITY  
**350 cc / 11 ¾ oz**

COLORI / COLOURS  
**Clear**

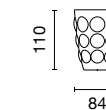



# Fresnel Collection

*Prende il nome dall'omonima lente la linea di calici  
Fresnel Beach, ispirata alle tradizionali coppe muranesi /  
Fresnel Beach, the line of glasses that draws inspiration  
for traditional Murano glasses*

design by LUCA NICHETTO



**IT** Realizzata in materiale plastico resistente quanto duttile, Fresnel presenta una decorazione tridimensionale della superficie che garantisce la resistenza ai graffi e ne amplifica i riflessi. Accattivante sul piano estetico, leggera e antigraffio, la nuova linea composta da un calice vino, un flûte da champagne e un tumbler, per i ristoranti e club più glamour, proponendo un nuovo stile per serate all'insegna di meravigliosi giochi di luce.

**EN** Made of resistant and supple plastic, Fresnel features a three-dimensional surface decoration for enhanced reflections and guarantees scratch-proof properties. The Fresnel line is charming, lightweight, non-scratch and consists of a wine glass, a champagne flûte and a tumbler. The line gives a new edge to glamorous restaurants and clubs proposing a new style for nights with wonderful plays of light.



## FRESNEL WINE

**art. 3946**

MATERIALE / MATERIAL  
**Policrystal®**

CAPACITÀ / CAPACITY  
**330 cc / 11 oz**

COLORI / COLOURS  
**Clear**



## FRESNEL FLÛTE

**art. 3947**

MATERIALE / MATERIAL  
**Policrystal®**

CAPACITÀ / CAPACITY  
**200 cc / 6 3/4 oz**

COLORI / COLOURS  
**Clear**



## FRESNEL PARTY

**art. 3948**

MATERIALE / MATERIAL  
**Policrystal®**

CAPACITÀ / CAPACITY  
**360 cc / 12 oz**

COLORI / COLOURS  
**Clear**



## Tonic Beach

*Bicchieri in policarbonato impilabili, disponibili in due capacità e perfetti per servire qualsiasi tipo di bibita | Stackable polycarbonate glasses, available in two different capacities that are ideal for serving all kinds of drinks*

design by CLAESSION KOIVISTO RUNE

**IT** Tonic beach, realizzato in Policrystal® infrangibile e lavabile in lavastoviglie, è stato pensato per servire long e soft drinks, come ogni tipo di bibita, dalla birra all'acqua. La forma conica lo rende perfettamente impilabile e dunque funzionale per l'ottimizzazione degli spazi in ambienti bar/club. Disponibile in due dimensioni (350 cc e 500 cc).

**EN** Tonic beach, made of unbreakable, dishwasher-safe, Policrystal® material, has been designed to serve long and soft drinks, and all types of drinks, from beer to water. Thanks to its conical shape, it is perfectly stackable, therefore functional for space optimization in bars/clubs. It comes in two sizes (350 cc and 500 cc).



### TONIC BEACH LARGE

art. 3903

MATERIALE / MATERIAL  
**Policrystal®**

CAPACITÀ / CAPACITY  
**500 cc / 16 ¾ oz**

COLORI / COLOURS  
**White Frost**

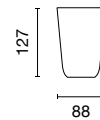

### TONIC BEACH MEDIUM

art. 3902

MATERIALE / MATERIAL  
**Policrystal®**

CAPACITÀ / CAPACITY  
**350 cc / 11 ¾ oz**

COLORI / COLOURS  
**White Frost**

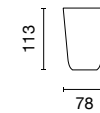

## Pachà Beach Light

*Bicchieri in polipropilene opalescente dalle caratteristiche ottimali per la preparazione di pestati e cocktail | Tumblers in opalescent polypropylene with optimum characteristics for the preparation of drinks made with crushed ice and cocktails*

design by ITALESSE

**IT** Tumbler in polipropilene opalescente infrangibile disponibile nelle due varianti Large e Medium. Fondo spesso e diametro della bocca studiato per interagire con lo shaker rendono questo bicchiere ideale per la preparazione di pestati e cocktail di ogni genere. Bestseller nei club di tutto il mondo per estetica e praticità.

**EN** Unbreakable, opalescent polypropylene tumbler available in two variants, Large and Medium. The thick bottom and the mouth diameter designed to fit the shaker make this glass the ideal solution to prepare all kinds of mashed cocktails and cocktails. Because of its look and convenience, it is a bestseller item in clubs all over the world.

### PACHÀ BEACH LIGHT LARGE

art. 3901

MATERIALE / MATERIAL  
**Polipropilene / Polypropylene**

CAPACITÀ / CAPACITY  
**500 cc / 16 ¾ oz**

COLORI / COLOURS  
**White Frost**

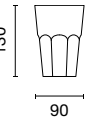

### PACHÀ BEACH LIGHT MEDIUM

art. 3900

MATERIALE / MATERIAL  
**Polipropilene / Polypropylene**

CAPACITÀ / CAPACITY  
**400 cc / 13 ½ oz**

COLORI / COLOURS  
**White Frost**

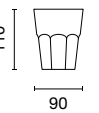



# Vas

*Caraffa ergonomica in vetro soffiato a bocca, dalla forte personalità /  
Ergonomic carafe in mouth-blown glass, with strong personality*

design by TODD BRACHER



**IT** Caraffa in vetro soffiato a bocca e lavorato a mano dalle linee sinuose ed eleganti. Vas è ideale per mantenere e servire acqua, succhi di frutta, soft drink e vini alla spina.

**EN** Mouth-blown, hand-crafted glass carafe with elegant and sinuous lines. The Vas carafe is ideal for serving water, fruit juice, soft drinks and draught wines.



VAS

art. 1425

MATERIALE / MATERIAL  
Vetro soffiato a bocca e lavorato a mano, materiale plastico tappo / Mouth-blown and hand-crafted glass, plastic stopper

CAPACITÀ / CAPACITY  
1000 cc / 33 1/4 oz

COLORI / COLOURS  
Clear



94

315

94



## Vertigo Decanter

*Il design a spirale si unisce alla ricercatezza del vetro soffiato a bocca e lavorato a mano nel nuovo Vertigo Decanter / The spiraling design meets the sophistication of mouth-blown and handcrafted glass in Vertigo Decanter*

design by ITALESSE



**IT** Vertigo Decanter è ideato per l'ossigenazione ottimale del vino, che può essere così esaltato e servito a tavola con finezza e vivacità. Un decanter ideale per servire il vino rosso, anche utilizzabile come caraffa per l'acqua e ogni genere di bevanda, essendo dotato di un tappo che ne permette l'utilizzo ai banchetti all'aperto.

**EN** Vertigo Decanter is ideal for optimal oxygenation of wine, elevating the taste and serving the wine at table with liveliness and delicacy. This decanter is perfect for serving red wine, but it is also usable as a carafe for water and any kind of beverage thanks to its stopper that allows the outdoor service.



**Acrylic Stopper**



VERTIGO DECANTER

**art. 1355**

MATERIALE / MATERIAL  
**Vetro soffiato a bocca e lavorato a mano / Mouth-blown, hand-crafted glass**

CAPACITÀ / CAPACITY  
**1500 cc / 50 ¾ oz**

COLORI / COLOURS  
**Clear**

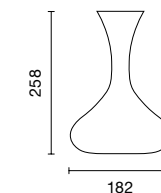



# Vinocchio

*Decanter in vetro soffiato dalle caratteristiche altamente professionali e dallo stile contemporaneo | Mouth-blown glass decanter with highly professional features and a contemporary style*

design by FEDERICO VENIER



**IT** Vinocchio deve ironicamente il suo nome e le sue linee al naso e al volto di Pinocchio. Concepito per ossigenare i vini rossi, questo decanter in vetro soffiato è caratterizzato da uno stile vivace e innovativo in tutti i dettagli: imboccatura con taglio obliquo, impugnatura ergonomica, bilanciamento ottimale, piquère profonda, base in materiale acrilico.

**EN** Vinocchio is a play on the name and shape of Pinocchio's nose and face. Designed to oxygenate red wines, this blown glass decanter is characterized by a brilliant and innovative style in all details: slanted mouth, ergonomic handling, excellent balance, deep piquère and acrylic base.

VINOCCHIO

art. 1335

MATERIALE / MATERIAL  
**Vetro soffiato a bocca, lavorato a mano** / decanter e acrilico base /  
**Mouth-blown hand-crafted glass** / decanter and acrylic base

CAPACITÀ / CAPACITY  
**1500 cc / 50 ¾ oz**

COLORI / COLOURS  
**Clear**

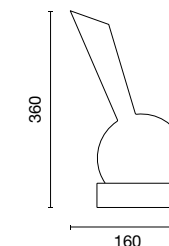

## Alavin

*Decanter caratterizzato da base basculante che lo rende capace di ruotare sulla tavola per ossigenare il vino oppure può essere appoggiato sulla base portaghiaccio per mantenere la temperatura ottimale del contenuto / Characterized by a swivelling base, Alavin rotates on tabletops for the decanting of fine wines or alternatively can be placed on the ice container to keep their contents chilled*

design by FEDERICO VENIER



**IT** Caratterizzato da una base basculante, Alavin è un decanter 'refrigeratore' che può essere lasciato libero di ruotare sulla tavola per decantare vini rossi invecchiati o essere appoggiato sulla base porta ghiaccio per mantenere il vino alla corretta temperatura. Molte volte, infatti, i vini rossi vengono serviti ad una temperatura troppo elevata rendendo inadatta la degustazione. Alavin è perfetto per servire anche freschi succhi di frutta o acqua nelle breakfast room degli hotel. Dotato di un tappo in acrilico trasparente che permette il servizio anche in banchetti all'aperto.

**EN** Characterized by a balancing base, Alavin is a "refrigerator" decanter, which can be let free to spin on the table to decant aged red wines or rest on the ice holding base to maintain wine at the right temperature. Many times, in fact, red wines are served at too high a temperature, which spoils their taste. Alavin is perfect to also serve fruit juices or water in hotel breakfast rooms. It comes with a clear acrylic stopper, which makes it suitable also for service in outdoor banquets.

SET ALAVIN

art. 1345

MATERIALE / MATERIAL  
**Vetro soffiato a bocca,**  
**lavorato a mano** *decanter*  
**e acrilico-silicone** *base /*  
**Mouth-blown hand-crafted**  
**glass** *decanter*  
**and acrylic-silicone** *base*

CAPACITÀ / CAPACITY  
**1700 cc / 57 ½ oz**

COLORI / COLOURS  
**Clear**

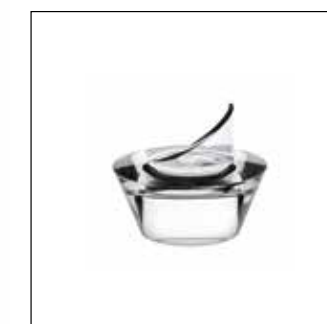
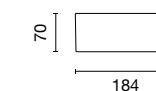
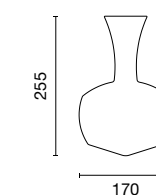



# Timber Bucket & Bowl

*La collezione abbina un design elegante, linee minimal e sofisticate al materiale innovativo chiamato Eco Wood, creando un prodotto innovativo, ecologico e personalizzabile | Timber Collection combines elegant design and minimal and sophisticated lines with an innovative material called Eco Wood, creating an innovative, organic and customizable product*

design by ITALESSE



**IT** La collezione Timber Bucket & Bowl abbina un design elegante e linee minimal e sofisticate ad un materiale innovativo chiamato Eco Wood, mai applicato prima nel settore. Eco Wood è una miscela ottenuta da materiali organici derivati dal legno, come lignina e cellulosa, e fibre e additivi naturali accuratamente bilanciati. Il composto così ottenuto è di derivazione naturale. Può essere utilizzato indoor e outdoor, è resistente, ha infinite possibilità di personalizzazione e diverse essenze di colore. Il cliente può richiedere una particolare tonalità del legno, colorare l'interno e decidere come applicare il proprio logo: marchio a fuoco, targa in alluminio, stampa.

**EN** The Timber Bucket & Bowl combines elegant design and minimal and sophisticated lines with Eco Wood, never applied before in the market. Eco Wood is a blend made from organic materials derived from wood, as lignin and cellulose, fibres and natural additives carefully mixed and balanced. . It can be used indoor or outdoor, is resistant, it can be customized in many ways and different colors variety. The customer can ask for a particular essence, varnish the inside and decide how to apply his brand: iron branding, aluminium label, print.



## TIMBER BUCKET

art. 1592

MATERIALE / MATERIAL  
Eco Wood

COLORI / COLOURS  
Naturale



Esotico



Carbone

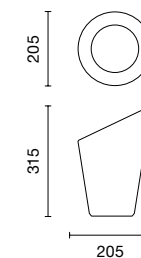

## TIMBER BOWL

art. 1618

MATERIALE / MATERIAL  
Eco Wood

COLORI / COLOURS  
Naturale



Esotico



Carbone

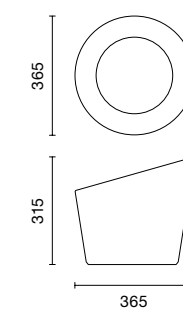

# Plaza Bucket & Bowl

*Un design all'avanguardia con una superficie sfaccettata che richiama il classico taglio del cristallo, il secchiello e la spumantiera Plaza catturano l'attenzione con un brillante gioco di luci | A pioneering design with a textured surface that evokes traditional cut crystal, the Plaza Bucket and Bowl draw your attention with its brilliant plays of light*

design by LUCA TRAZZI



**IT** Il secchiello e la spumantiera Plaza sono estremamente luminosi grazie alla loro realizzazione in materiali acrilici di qualità cristallina. L'effetto scintillante è accentuato dall'aggiunta di una base LED ricaricabile opzionale che illumina il ghiaccio e le bottiglie contenute. Plaza è perfettamente impilabile.

**EN** The Plaza Bucket and Bowl are extremely luminous and are made with crystalline quality acrylic materials. The scintillating effect is heightened with the addition of an optional, rechargeable LED base which illuminates the ice and the bottles it contains. Plaza is fully stackable.



Disponibile con base LED / Available with LED base

## PLAZA BUCKET

art. 1584

MATERIALE / MATERIAL  
Acrilico / Acrylic

COLORI / COLOURS  
Clear

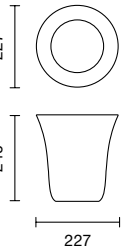

## PLAZA BOWL

art. 1616

MATERIALE / MATERIAL  
Acrilico / Acrylic

COLORI / COLOURS  
Clear

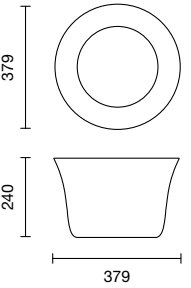



## Vela Bucket & Bowl

*Un secchiello ed una spumantiera dalla forma armonica e innovativa, esaltata ancor di più dalla base luminosa che mette in risalto la lucentezza dell'acrilico e le bottiglie in esso contenute / A bucket and a bowl with harmonious and innovative shapes. The led bases enhance the beauty of these items further and highlight the brilliance of the acrylic and the bottles they contain*

design by ITALESSE



**IT** Il secchiello e la spumantiera Vela posseggono un design curvo che richiama l'eleganza di una vela ed un bordo a taglio diamantato che valorizza la luminosità e gli spessori. Realizzati in materiale ad alta trasparenza, i Vela di Italesse possono essere illuminati grazie a una base LED ricaricabili ed utilizzati come supporto espositivo. La forma innovativa, con la schiena a ventaglio, attira l'attenzione ed esalta il valore delle bottiglie in essi contenute, l'ergonomia li rende semplici da utilizzare.

**EN** Designed with elegant curves the Vela Bucket and Bowl echo the forms of a wind-filled sail, a diamond-cut edge heightens the luminosity of these containers. Manufactured in highly transparent material, Vela objects can furthermore be illuminated with a rechargeable LED base and used as bottle-glorifiers. Their unique shape with their fan-shaped back capture the onlooker's attention and serve to highlight the value of the bottles contained as well as giving them a highly ergonomic design.



Disponibile con base LED /  
Available with LED base

## VELA BUCKET

art. 1583

MATERIALE / MATERIAL  
Acrilico / AcrylicCOLORI / COLOURS  
Clear

White



271

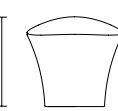

207

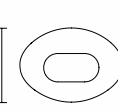

288

## VELA BOWL

art. 1615

MATERIALE / MATERIAL  
Acrilico / AcrylicCOLORI / COLOURS  
Clear

White



282



282

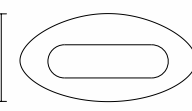

566

## VELA BUCKET ROUND

art. 1589

MATERIALE / MATERIAL  
Acrilico / AcrylicCOLORI / COLOURS  
Clear

White



Black



313,5



240



210

## VELA BOWL ROUND

art. 1617

MATERIALE / MATERIAL  
Acrilico / AcrylicCOLORI / COLOURS  
Clear

White



Black



313,5



360,5



317,5

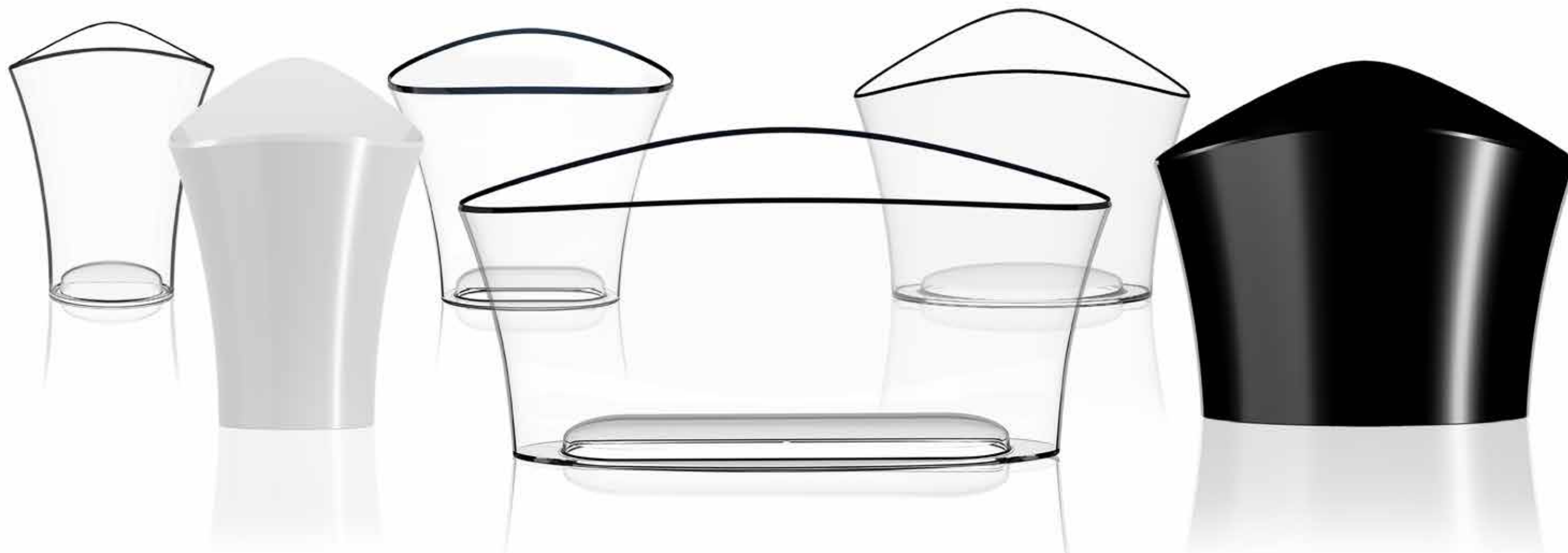



## Bolle Bucket & Bowl

*Vere icone della collezione Italesse, il secchiello e la spumantiera Bolle sono interamente ricoperte da sfere di materiale acrilico trasparente, che le rendono luminose ed eleganti | Icons in Italesse's collection, Bolle Bucket and Bowl are completely covered with clear acrylic spheres, which make them extremely bright and elegant*

design by LUCA TRAZZI





**IT** Esaltata dai tanti e continui giochi di luce, la collezione Bolle si caratterizza per la leggerezza della luminosità, il suo stile e la sua raffinatezza. Adatta ad ambienti indoor e outdoor e a ogni tipo di tavola.

**EN** Enhanced by uninterrupted plays of light, the Bolle collection is characterized by its style, luminosity and elegance, which makes it suitable for indoor and outdoor environments and all types of tables.



## BOLLE BUCKET

art. 1586  
art. 1587 - Bolle Bucket Pro\*

MATERIALE / MATERIAL  
Acrilico / Acrylic

COLORI / COLOURS  
Clear

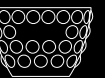
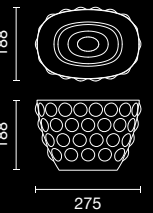

\*Bolle Bucket Pro  
personalizzabile /  
customizable

## BOLLE BOWL

art. 1612  
art. 1613 - Bolle Bowl Pro\*

MATERIALE / MATERIAL  
Acrilico / Acrylic

COLORI / COLOURS  
Clear

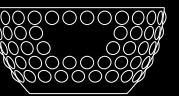
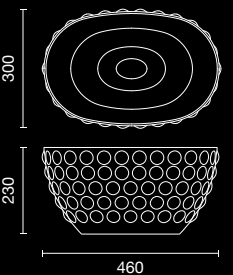

\*Bolle Bowl Pro  
personalizzabile /  
customizable



## Solomon Bucket

*Con Solomon Italesse rinnova l'immagine del secchiello e porta in tavola un prodotto ispirato alla sinuosità del Guggenheim di New York. Il secchiello infatti può essere arricchito con una base luminosa LED che rifrange la luce attraverso il materiale plastico | Italesse renews the image of the traditional ice-bucket with Solomon presenting an iconic item that takes its inspiration from the sinuous Guggenheim Museum of New York. The LED lighting of the optional base refracts and illuminates the plastic material*

design by CARLOS TÍSCAR



**IT** Solomon, un singolare secchiello portagiaccio pensato con una chiara idea dell'utilizzo finale ed un'estetica accattivante. Realizzato da Tiscar riesce, con il suo design, a donare movimento all'oggetto e grazie alla sua superficie permette una presa sicura ed un alto grado di maneggevolezza. Solomon, grazie alle sue proporzioni generose e alla sua immagine altamente iconica e riconoscibile, è ideale per rendere davvero unici ambienti bar o club. Il secchiello infatti può essere arricchito con una base luminosa LED che rifrange la luce attraverso il materiale plastico, illuminando aperitivi intimi e grandi serate glamour.

**EN** Solomon, a singular ice-bucket conceived with a clear underlying functional concept and a captivating aesthetic. Made in the form of a spiral that turns on itself Tiscar's design awards the piece movement and moreover creates a ridged surface that promotes grip and easy handling. Thanks to its large, practical size, Solomon is the perfect ally to make bars or clubs truly unique with its highly iconic and recognizable image. The LED lighting of the optional base refracts through the plastic material and illuminates the most secluded corners of any venue for intimate aperitifs, adding a touch of glamour in exclusive clubs.



Disponibile con base LED /  
Available with LED base

SOLOMON BUCKET

art. 1585

MATERIALE / MATERIAL  
Acrilico / Acrylic

COLORI / COLOURS  
Clear White

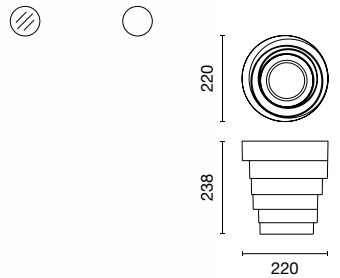

# Pagoda Bucket & Gran Pagoda Bowl

*Un secchiello ed una spumantiera in materiale acrilico dalle forme squadrate, decise e perfettamente impilabili | An acrylic Bucket and Bowl with bold, square shapes that are perfectly stackable*

design by FEDERICO VENIER

**IT** La spumantiera Gran Pagoda è in grado di contenere e rinfrescare fino a 6 bottiglie di vino o spumante. Perfettamente impilabile e con maniglia incassata che evita la fuoriuscita di ghiaccio e acqua, è ideale sui banconi dei bar, nei party e in occasione di feste anche a casa. Pagoda Bucket è studiato per rinfrescare e trasportare comodamente una bottiglia, anche usando una sola mano.

**EN** The Gran Pagoda Bowl is suitable for up to 6 wine or champagne bottles. Fully stackable, its indented handle prevents the spillage of ice and water. A multi-purpose container that is a must-have for parties or bar counters. The Pagoda Bucket is designed to cool and comfortably carry a bottle even with just one hand.

## PAGODA BUCKET

art. 1545

MATERIALE / MATERIAL  
**Acrilico / Acrylic**

COLORI / COLOURS  
**Clear Black**

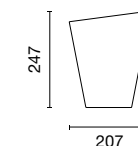

## PAGODA BUCKET MIRROR

art. 1700

MATERIALE / MATERIAL  
**Inox**

COLORI / COLOURS  
**Inox**

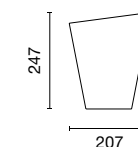

## GRAN PAGODA BOWL

art. 1610

MATERIALE / MATERIAL  
**Acrilico / Acrylic**

COLORI / COLOURS  
**Clear Black**

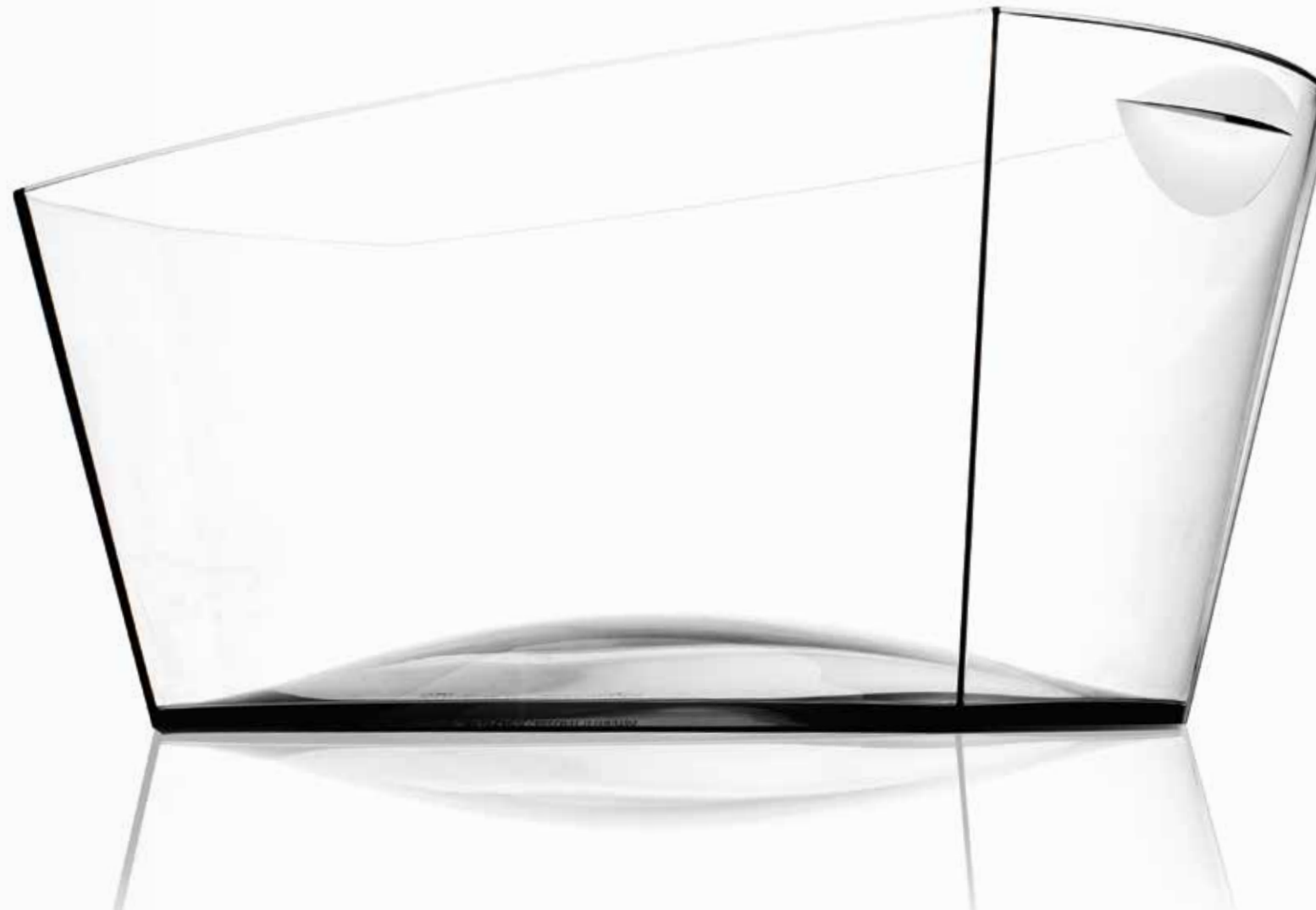
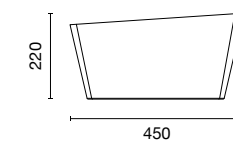
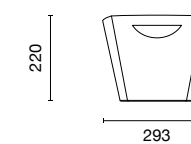



# Tonic Ice Bucket & Bowl

*Tonic Ice Bucket e Tonic Ice Bowl riprendono le linee coniche del bicchiere Tonic della collezione Italesse e reinventano lo stile di uno strumento ideale per il mondo della notte | Tonic Ice Bucket and Tonic Ice Bowl take the cone shaped lines of the Tonic glass of the Italesse collection and reinvent the style for an ideal tool for the night world*

design by CLAESSON KOIVISTO RUNE



**IT** Un secchiello ed una spumantiera dalle linee semplici ma distintive. Dotati di una base luminosa interna, Tonic Ice Bucket & Bowl permettono di illuminare le bottiglie in essi contenute grazie all'estrema trasparenza del materiale acrilico di cui si compongono.

**EN** An ice bucket and Champagne bowl with simple, yet distinctive lines. An optional LED base illuminates the bottles they contain by virtue of the extreme transparency of the acrylic material of which the Bucket and Bowl are made.



**Disponibile con base LED / Available with LED base**

TONIC ICE BUCKET

**art. 1588**

MATERIALE / MATERIAL  
**Acrilico / Acrylic**

COLORI / COLOURS  
**Clear**

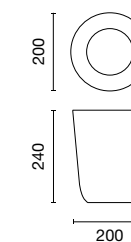

TONIC ICE BOWL

**art. 1614**

MATERIALE / MATERIAL  
**Acrilico / Acrylic**

COLORI / COLOURS  
**Clear**

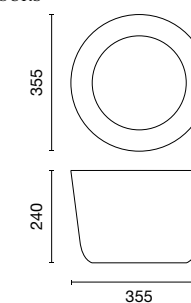

# Easy Buckets & Bowls

*Easy è la linea di secchielli e spumantiere dall'eleganza raffinata e formale | Easy is the refined, elegant and formal line of ice Buckets and Champagne Bowls*

design by FEDERICO VENIER

**IT** I secchielli e le spumantiere Easy sono caratterizzati da linee inclinate ed opposte del bordo superiore e del fondo. Questo particolare valorizza la bottiglia come se fosse posata su un supporto espositivo. Il loro bordo esterno a “taglio diamantato” ne valorizza la luminosità e gli spessori utilizzati. La spumantiere di questi modelli è studiata per cinque bottiglie di vino, quattro da Champagne, mentre il secchiello è ideale per una sola bottiglia per i modelli Square e Round e per due bottiglie per il modello Oval.

**EN** The collection of Easy Buckets and Bowls are characterized by slanted and opposed lines of the top edge and the base: this detail enhances the visibility of the bottle as if it were laid on a display support. Their top “diamond-shaped cut” edge enhances their brightness and thickness. The Champagne Bowls of these models are designed to contain up to five wine bottles or four champagne bottles, while the Bucket is ideal for a single bottle in the Square and Round models and up to two bottles in the Oval model.

## EASY BUCKET OVAL

art. 1580

MATERIALE / MATERIAL  
Acrilico / Acrylic

COLORI / COLOURS  
Clear



White

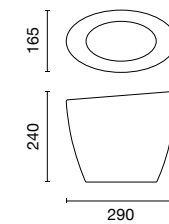

## EASY BOWL OVAL

art. 1609

MATERIALE / MATERIAL  
Acrilico / Acrylic

COLORI / COLOURS  
Clear



White

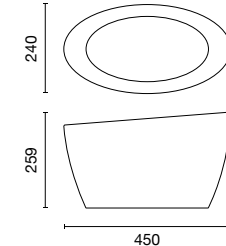

## EASY BUCKET SQUARE

art. 1578

MATERIALE / MATERIAL  
Acrilico / Acrylic

COLORI / COLOURS  
Clear



Black

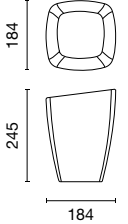

## EASY BOWL SQUARE

art. 1607

MATERIALE / MATERIAL  
Acrilico / Acrylic

COLORI / COLOURS  
Clear



Black

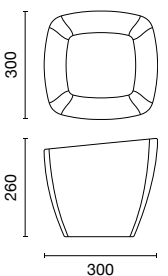

## EASY BUCKET ROUND

art. 1574

MATERIALE / MATERIAL  
Acrilico / Acrylic

COLORI / COLOURS  
Clear



Black

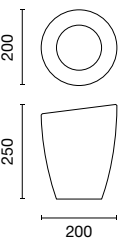

## EASY BOWL ROUND

art. 1605

MATERIALE / MATERIAL  
Acrilico / Acrylic

COLORI / COLOURS  
Clear



Black

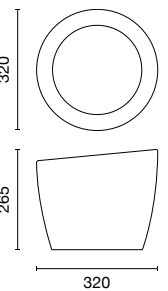



## Bongo Bucket & Bowl

*Caratterizzati da linee morbide e con una forma ellittica, il secchiello e la spumantiera Bongo sono oggetti dotati di una presenza forte e dal richiamo irresistibile al tavolo dei drink. Bongo Bucket e Bongo Bowl garantiscono una scorta di drink perfettamente ghiacciati per ogni occasione | With their soft lines and elliptical design the Bongo Bucket and Bongo Bowl, represent a captivating item for the drinks table. Bongo Bucket and Bowl provide perfectly cooled drinks for every occasion*

design by MINEDIVINE

**IT** Bongo Bowl può contenere nel ghiaccio fino a 5 bottiglie di vino e champagne o diverse bottiglie di piccolo formato. Bongo Bucket può ospitare una bottiglia anche inclinata. Ergonomico, di facile manutenzione e molto resistente, Bongo è realizzato in pregiato materiale acrilico altamente trasparente ed è ideale per bar, ristoranti e club.

**EN** Bongo Bowl can hold up to 5 champagne and wine bottles or several small bottles on ice. Bongo Bucket can also hold a tilted bottle. Ergonomic, easy to maintain and very strong, Bongo is made of premium, clear acrylic material and is an ideal solution for bars, restaurants and clubs.

### BONGO BUCKET

**art. 1562**

MATERIALE / MATERIAL  
**Acrilico / Acrylic**

COLORI / COLOURS  
**Clear**

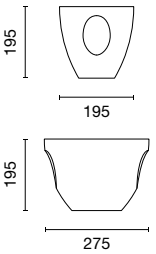

### BONGO BOWL

**art. 1630**

MATERIALE / MATERIAL  
**Acrilico / Acrylic**

COLORI / COLOURS  
**Clear**

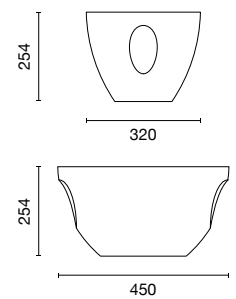

## Stainless Steel Collection

*Una linea in acciaio inossidabile di secchielli e spumantiera, perfetta per rinfrescare nel ghiaccio le bottiglie di ogni formato elevandone la presentazione al bar ed a tavola | A stainless steel range of buckets and bowl, perfect to refresh bottles of each size elevating their presentation at bar or on the table*

design by ITALESSE



**IT** Winston Bucket è un secchiello da Champagne in acciaio inox inossidabile. Elegante, resistente ed impilabile, Winston Bucket è ideale per rinfrescare la bottiglia in esso contenuta ed accompagnare il servizio professionale con stile. Nella versione large, Winston Bucket Large è dotato di pomelli laterali e può contenere anche 2 bottiglie di vino. Nevada Bowl è perfetta per esporre e mantenere fresche nel ghiaccio fino a 5 bottiglie di Champagne.

**EN** Winston Bucket is a stainless steel Champagne bucket. Elegant, resistant and stackable, Winston Bucket is perfect for chilling the bottle it contains and it gives style to professional serving. In its larger version, Winston Bucket Large with knobs can contain up to 2 bottles of wine. Nevada Bowl is excellent for presenting and keeping up to 5 bottles of Champagne chilled on ice.

### WINSTON BUCKET

art. 1707

MATERIALE / MATERIAL  
Stainless steel

COLORI / COLOURS  
Inox

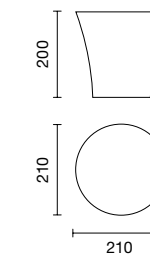

### WINSTON BUCKET LARGE

art. 1708

MATERIALE / MATERIAL  
Stainless steel

COLORI / COLOURS  
Inox

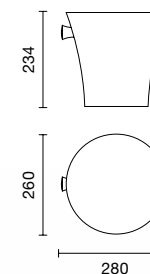

### NEVADA BOWL

art. 1709

MATERIALE / MATERIAL  
Stainless steel

COLORI / COLOURS  
Inox

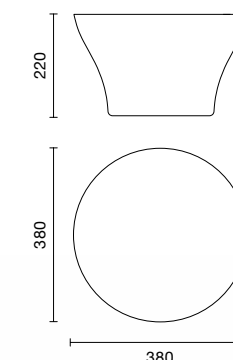



# Aria

*Cassa display per bottiglie, che protegge ed esalta le bottiglie di vino e spirits contenute | A bottle display case that serves to protect and highlight the wine and spirits bottles it contains*

design by LA SCENA



**IT** Aria è concepita per esaltare le bottiglie, diventando una nuova soluzione per la presentazione dei vini, realizzata in acrilico altamente trasparente. La cassa Aria può contenere fino a 6 bottiglie ed è dotata di divisori interni personalizzabili per contenere bottiglie di diverse dimensioni e forme. Senza coperchio e senza divisori interni l'oggetto diventa un'originale e pratica spumantiera per il ghiaccio, ideale per esporre le bottiglie.

**EN** The item is designed to highlight the bottles, making it an innovative solution for the presentation of wines, made in highly transparent acrylic. The Aria display case can contain up to 6 bottles and it has internal dividers that are customizable to contain different bottle shapes and sizes. Aside from its use as a display-case, Aria becomes a practical ice-bowl for chilling and presenting winebottles by simply removing its sliders and cover.

ARIA

art. 1900

MATERIALE / MATERIAL  
Acrilico / Acrylic

COLORI / COLOURS  
Clear

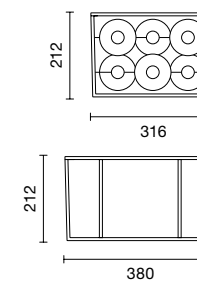

Utilizzabile come spumantiera /  
Can be used as bowl

# Wine 360°

*L'installazione sugli aromi che cambia il modo di degustare e parlare di vini e alcolici | The installation on aromas that changes the way of tasting and talking about wines and spirits*

design by WINE REVOLUTION



**IT** Wine 360° è una installazione realizzata interamente a mano che, concepita come oggetto di design e arredo e allo stesso tempo strumento didattico e mezzo di comunicazione, è pensata per esaltare le storie e le esperienze sensoriali legate a vini, alcolici e altri prodotti. La colonna, realizzata in acrilico altamente trasparente, è un display su ruote che permette di mostrare e “raccontare” il suolo, il vitigno ed il vino, mentre l’ampolla, realizzata in vetro, fa vivere una esperienza visiva, olfattiva ed emozionale unica che consente di esplorare il vino in un modo nuovo. Da oggi Wine 360° è disponibile anche nella versione Desk che coniuga l’esperienza emozionale con la praticità d’uso.

**EN** Wine 360° is an hand made installation that is designed as a piece of furniture, an educational tool and a communication tool, is created to enhance stories and sensorial experiences connected to wine, spirits and other products. The column, in high transparent acrylic, is a wheeled display that allows to show and tell about the soil, the vines and wine. The flask, glass made, gives you a unique visual, olfactory and emotional experience that let you explore the wine in a new way. Wine 360° is now available in the new Desk version, a user friendly product which maintains its emotional force.



WINE 360° SET

**art. 1907**

MATERIALE / MATERIAL

**Colonna: plexiglass. Ampolla: vetro /  
Column: plexiglass. Flask: glass**

COLORI / COLOURS

**Clear**

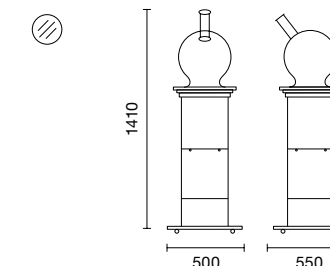

WINE 360° DESK

**art. 1911**

MATERIALE / MATERIAL

**Ampolla: vetro. Base: Acrilico /  
Flask: glass. Base: Acrylic**

COLORI / COLOURS

**Clear**

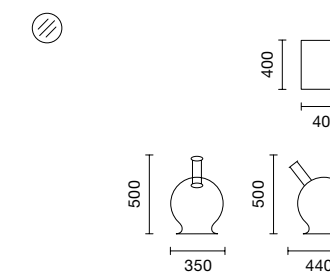



# Stripe

*Con un profilo sinuoso e futuristico, Stripe è un vassoio dal forte impatto estetico | With its sinuous and futuristic shape, Stripe is a highly decorative tray*

design by LUCA NICHETTO



**IT** Vassoio in materiale ABS, composto da una fascia esterna nera che avvolge un piano rivestito in materiale soft-touch, con funzione anti-scivolo. Le pareti interne rialzate garantiscono grande sicurezza e comodità nel trasporto di piatti e bicchieri e garantiscono una sicurezza ottimale nel servizio anche in condizioni "estreme".

**EN** A sturdy ABS tray, consisting of a black external band that encircles a surface covered with a soft-touch finish that gives extra hold to the tray contents making it anti-slip. The raised internal walls guarantee safety and comfort when carrying plates and glasses, and guarantee excellent security during busy service and extreme conditions.



STRIPE

art. 6035

MATERIALE / MATERIAL  
**ABS**

COLORI / COLOURS  
**Black**

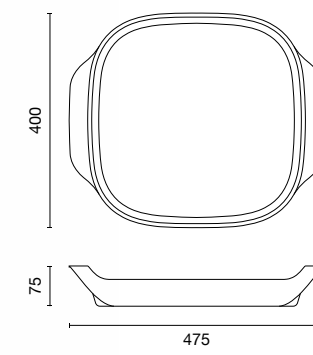



## Bolle Cake Stand

*L'alzatina Bolle Cake Stand di Italesse cattura l'occhio in qualsiasi contesto e diventa elemento centrale su qualsiasi tavola per l'originale gioco di bolle ad incastro | A unique and polyvalent cake stand that catches the eye in every context and becomes central feature of every table for its original play on light*

design by LUCA TRAZZI



**IT** Caratterizzata da ricche sfere che ricoprono la parte inferiore dell'alzata e da una sinuosa cupola che la ricopre, Bolle Cake Stand diventa, grazie al design vivace e stravagante, un elemento centrale su qualsiasi tavola. Accessorio indispensabile per presentare e servire crostate e torte, nonché selezioni di formaggi o gustosi aperitivi take-away, Bolle Cake Stand è ideale nei bar, per i servizi catering o semplicemente perfetta a casa per presentazioni dal carattere distintivo che vogliono valorizzare il rito della tavola sia in situazioni intime che in affollati momenti conviviali.

**EN** An indispensable accessory for serving and presenting tarts and cakes as well as varied cheese selections with elegance and originality. Ideal for bars, catering services and just perfect for the home. The Bolle Cake Stand's underside is covered with rich bubbles that refract light and make it the central feature of any table. Complete with its own lightweight cover, Italesse's Bolle Cake Stand makes for a distinctive presentation that serves to shed light on the serving ritual in intimate as well as busy, convivial contexts.

BOLLE CAKE STAND AND DOME

art. 5080  
art. 5090

MATERIALE / MATERIAL  
Vetro lavorato a mano /  
Hand-crafted glass cake stand  
SAN dome

COLORI / COLOURS  
Clear

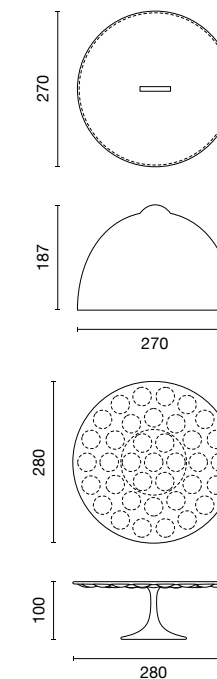



## Pebble

*Ciotole dalla particolare silhouette che rimanda ai sassolini dei fiumi, con gli angoli smussati che richiamano l'azione dell'acqua corrente / Bowls with the silhouette of a river pebble, with edges smoothed and rounded by the rushing current*

design by NENDO



**IT** Impilabili, minimali ma dotate di grande forza estetica, le ciotole in melamina Pebble possono essere utilizzate per servire snack, olive, finger food ma anche fresche insalate, macedonie, gelati e dolci al cucchiaio.

**EN** Stackable, minimal, yet featuring great aesthetic impact, the melamine bowls Pebble are suitable for serving snacks, olives, finger food and fresh salads, fruit salads, ice creams and desserts.



## PEBBLE SET

art. 5070

MATERIALE / MATERIAL  
Melamina / MelamineCOLORI / COLOURS  
Mixed Colors

Black - art. 5072

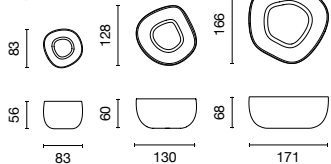

## PEBBLE MEDIUM

art. 5061

MATERIALE / MATERIAL  
Melamina / MelamineCOLORI / COLOURS  
Black

Orange

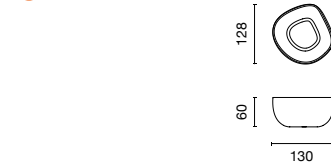

## PEBBLE LARGE

art. 5062

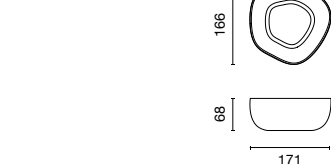
MATERIALE / MATERIAL  
Melamina / MelamineCOLORI / COLOURS  
Black

## PEBBLE SMALL

art. 5060

MATERIALE / MATERIAL  
Melamina / MelamineCOLORI / COLOURS  
White Black

## Djambè Tapas

*Pratiche ciotole in policarbonato infrangibile caratterizzate da una spiccata multifunzionalità | Practical unbreakable polycarbonate bowls characterised by multipurpose features*

design by LOOKOUT

**IT** Ideate per accogliere olive, snack, insalate, gelati, appetizer, finger food, le ciotole in policarbonato Djambè Tapas sono pratiche ciotole infrangibili, lavabili in lavastoviglie ed impilabili.

**EN** Designed for serving olives, snacks, fresh salads, ice creams, appetizers and finger food, Djambè Tapas are unbreakable polycarbonate bowls that are dishwasher safe and stackable.



## DJAMBÈ TAPAS LARGE

art. 6020

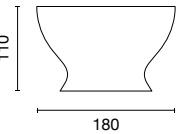
MATERIALE / MATERIAL  
Polycrystal®COLORI / COLOURS  
Clear

## DJAMBÈ TAPAS MEDIUM

art. 6021

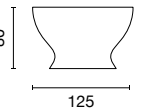
MATERIALE / MATERIAL  
Polycrystal®COLORI / COLOURS  
Clear



# Venti4

*Set di piatti e ciotole componibili in bianca melamina satinata per aperitivi e stuzzichini | Combinable set of plates and bowls in white melamine with satin finish for appetizers and snacks*

design by LUCA NICHETTO



**IT** La Venti4 Family è una collezione di piatti e ciotole in melamina satinata, lavabile in lavastoviglie e studiata per offrire un servizio completo, dallo snack veloce, all'aperitivo fino al piatto di servizio – tutti pensati con un design davvero innovativo e originale. Una collezione di piatti a croce, ciotole di varie dimensioni sovrapponibili e assemblabili a piacimento, ideali per servire snack, sushi, salse e guarnizioni – ideati per ridefinire in maniera innovativa il più classico dei posti tavola, i bar più trendy o i club più straordinari.

**EN** The Venti4 Family is an articulated collection of satin-finished melamine plates and bowls. Entirely dishwasher-safe, it is designed as a solution for a complete service, from quick snacks, to aperitifs or a plate for table service, all with a truly innovative and original design. A collection of flat, square and cross-shaped cups, stackable and freely assembled bowls of several sizes that are ideal to serve snacks, sushi, sauces and garnishes, created to redefine in an innovative fashion the most classical table, the trendiest bars, or the most luxurious clubs.

## VENTI4 SQUARE CROSS

art. 5054

MATERIALE / MATERIAL  
Melamina / Melamine

COLORI / COLOURS  
White

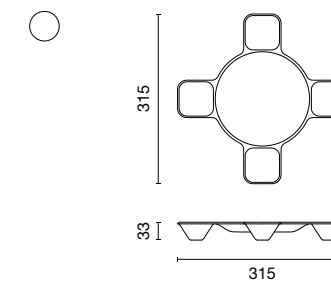

## VENTI4 OVAL CROSS

art. 5053

MATERIALE / MATERIAL  
Melamina / Melamine

COLORI / COLOURS  
White

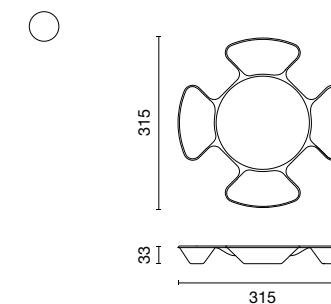

## VENTI4 SMALL CUP

art. 5052

MATERIALE / MATERIAL  
Melamina / Melamine

COLORI / COLOURS  
White

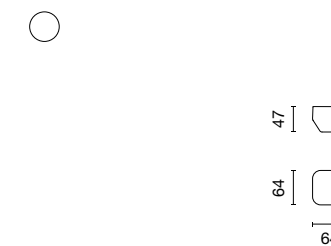



# Lollipop

*Pratico, colorato, divertente, queste le caratteristiche dello stopper Lollipop / Practical, brightly coloured, fun, these are the characteristics of the Italesse wine-stopper Lollipop*

design by MARCO ZANATTA



**IT** Realizzato in silicone in tre brillanti tonalità di colore, il tappo per bottiglie si presenta a forma di occhiello circolare. Originale ed essenziale, può essere appeso al collo della bottiglia nella fase di riposo, trasformando un dettaglio estetico in dettaglio funzionale.

**EN** Manufactured in silicone in three bright colors, this wine stopper takes the form of a round loop or ring. Original and minimalist in style, it can be hung from the bottle's neck when at rest, transforming an aesthetic detail into a functional feature.

LOLLIPOP

art. 1042

MATERIALE / MATERIAL  
Silicone / Silicone

COLORI / COLOURS  
White Black



Red

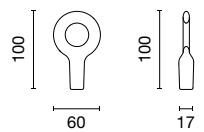



## Ocean Stopper

*Tappo funzionale, pratico e dall'appeal elegante in grado di conservare perfettamente spumanti e Champagne nel migliore dei modi | Functional, practical stopper with an elegant aesthetic that preserves the quality of Champagne and sparkling wines*

design by MINEDIVINE

OCEAN STOPPER

art. 1040

MATERIALE / MATERIAL  
 Acrilico, silicone e acciaio inox /  
 Acrylic, silicone and stainless steel

COLORI / COLOURS

Clear

White



Black

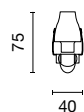

**IT** Questo stopper è il frutto della ricerca effettuata insieme ai migliori produttori di champagne del mercato; Italesse ha contribuito dando il suo tocco in termini di design. I materiali usati sono l'acrilico, la gomma alimentare per la tettarella e l'acciaio inox per il gancio. La particolarità della tettarella è data dal fatto che con la pressione dello champagne essa si allarga e aderisce alle pareti del collo della bottiglia, garantendo la massima tenuta.

**EN** This stopper is the result of the research made together with the best champagne producers on the market; Italesse has contributed from the design point of view. Materials used are acrylic, food-grade rubber for the teat and stainless steel for the clasp. The unique feature of the teat is that it expands under the champagne pressure and adheres to the internal walls of the bottle's mouth to guarantee an airlocked seal and thus the wine retains its sparkling properties.

## Fiesta Stopper & Fiesta Stopper Plus

*Fiesta, divertimento ed eleganza: uno stopper completamente personalizzabile, che preserva perfettamente spumanti e Champagne | Fiesta, fun and elegance: a fully customizable stopper that perfectly preserves sparkling wines and Champagne*

design by ITALESSE

FIESTA STOPPER & FIESTA STOPPER PLUS

art. 1043 - Fiesta Stopper  
 art. 1044 - Fiesta Stopper Plus

MATERIALE / MATERIAL  
 Acrilico, silicone e acciaio inox /  
 Acrylic, silicone and stainless steel

COLORI / COLOURS

Clear

White



Black



**IT** Fiesta Stopper conserva le proprietà delicate e gli aromi di tutte le varietà degli spumanti, grazie al suo collaudato meccanismo del gancio e alla tettarella espandibile in silicone. La sua forma richiama il tradizionale tappo da Champagne in sughero, mentre la reinterpretazione in materiale plastico gli dona un taglio decisamente contemporaneo. Nella versione Plus un'innovazione: una capocchia opzionale da inserire sulla testa dello stopper per una personalizzazione alternativa.

**EN** Fiesta Stopper preserves the delicate properties and aromas of all varieties of sparkling wine, thanks to its tried and tested hook and expandable silicone teat mechanism. Its button top evokes the traditional Champagne cork and Fiesta's interpretation in plastic material gives the accessory a contemporary edge. In the Fiesta Stopper Plus model there is an innovative extra feature: an optional personalizable cap that can be inserted on its head offering an alternative solution for customization.

# **Designers & Opinion Leaders**



**Todd Bracher**

👤 Designer - Industrial and Product Design.  
 📍 New York, USA.  
 🗑️ Italesse Projects: Vas Carafe.

**Claesson Koivisto Rune**

👤 Design Studio - Industrial Design, Architecture & Interior Design, Product Design.  
 📍 Stockholm, Sweden.  
 🗑️ Italesse Projects: Richard Juhlin Optimum Champagne Glass, Tonic Glassware and Ice-Buckets.

**Minedivine**

👤 Design Studio - Industrial, Product and Graphic Design.  
 📍 Treviso, Italy.  
 🗑️ Italesse Projects: Bongo Ice-Buckets, Organica Carafe, Ocean Stopper, Sfera Glassware.

**Luca Nichetto**

👤 Designer - Industrial Design, Architecture, Product Design.  
 📍 Stockholm, Sweden.  
 🗑️ Italesse Projects: Stripe Tray, Venti4 and Fresnel Collections.

**Marco Zanatta**

👤 Designer - Product Design.  
 📍 Varese, Italy.  
 🗑️ Italesse Projects: Lollipop Stopper.

**Giancarlo Mancino**

👤 Opinion Leader - Bartender / Bar Consultant.  
 📍 Hong Kong.  
 🗑️ Italesse Projects: Wormwood Glassware.

**Richard Juhlin**

👤 Opinion Leader - Champagne Expert.  
 📍 Stockholm, Sweden.  
 🗑️ Italesse Projects: Richard Juhlin Optimum Champagne Glass.

**Maîtres Cuisiniers de France**

👤 Opinion Leader - Largest Worldwide French Chef association.  
 📍 Paris, France.  
 🗑️ Italesse Projects: Etoilé Glassware.

**Nendo**

👤 Designer - Industrial Design, Architecture, Product Design.  
 📍 Tokyo, Japan.  
 🗑️ Italesse Projects: Pebble Bowls.

**Carlos Tíscar**

👤 Designer - Industrial and Product Design.  
 📍 Valencia, Spain.  
 🗑️ Italesse Projects: Solomon Ice-Buckets.

**Luca Trazzi**

👤 Designer - Industrial and Product Design, Architecture.  
 📍 Milano, Italy.  
 🗑️ Italesse Projects: Bolle Glassware, Ice-Buckets and Accessories, Wormwood Glassware, Plaza Ice-Buckets.

**Federico Venier**

👤 Designer - Industrial Design, Architecture & Interior Design, Product Design.  
 📍 London, UK.  
 🗑️ Italesse Projects: Vinocchio and Alavin Decanters, Easy Ice-Buckets, Pagoda and Grand Pagoda Ice-Buckets.

**Luca Bini**

👤 Opinion Leader - AIS Sommelier and Hospitality Professional.  
 📍 Trento, Italy.  
 🗑️ Italesse Projects: Etoilé Sparkle Flute.

**Paolo Lauria**

👤 Marketing and Project Manager Italesse - AIS Sommelier  
 📍 Firenze, Italy  
 🗑️ Italesse Projects: Senses, Wine 360°

**Photography:**  
Thomas Zanon Larcher  
Roberto Maffioli / Italesse  
Escapista  
Azimut Photo / Massimo Gardone  
Roberto Pastrovicchio

**Graphic Design:**  
Fabrizio Gabrielli

**Print:**  
Grafica Goriziana

**Italesse s.r.l.**

**Via Dei Templari 6  
loc. Noghere - 34015 Muggia  
Trieste - Italy**

**T +39 040 9235555  
F +39 040 9235251**

**italesse@italesse.it  
www.italesse.com**

**© 2020**