

italiaesse

Prodotti / Products

Progettare con gli aromi / Designing with aromas



Recentemente Italesse ha ulteriormente ampliato il proprio savoir-faire professionale relativo al mondo del vino con Senses, un progetto che ha come obiettivo finale quello di coniugare emozioni ed eccellenza tecnica nella degustazione. Il team di Italesse Senses ha rivoluzionato il modo di immaginare e progettare i prodotti destrutturando i singoli vini in aromi, testando i calici sia con il vino che direttamente con ribes, lamponi, pepe nero, e apportando essenziali modifiche e micro-modifiche alla struttura del bicchiere per migliorare proprio le percezioni sensoriali ed olfattive. Questo lavoro ha permesso di andare oltre l'idea del calice varietale perché ogni vino è unico e, ad esempio, un pinot nero di una regione è a volte molto diverso da quello di un'altra. Si afferma così l'idea del calice emozionale che rispetta l'unicità di ogni vino e le sensazioni organolettiche ad esso legate. L'attenzione di Italesse ai dettagli, alla qualità dei materiali, all'efficienza tecnica professionale dei prodotti, nonché verso l'atto creativo è, ormai da tempo, affiancata dall'impegno verso temi come l'etica e l'ambiente che ci circonda. Impegno che è stato premiato, al termine del 2019, con la medaglia d'argento EcoVadis, prestigioso riconoscimento internazionale relativo alla sostenibilità.

Lately, Italesse further expanded its professional savoir-faire related to the wine world with the new Senses project, which aims to combine emotions and technical excellence in the tasting experience. The Italesse Senses team completely transformed the way the products are designed and imagined, deconstructing the individual wines into aromas by testing, for instance, the stem glass directly with wine as well as with only currants, raspberries, and black pepper. Then comes essential changes - sometimes incredibly tiny - to the stem glass structure, which greatly improves sensorial and olfactory perceptions. The work done by the Italesse Senses team goes beyond the idea of the varietal stem glass because every wine is unique, like a Pinot Noir that can differ greatly from one region to another. The results of this work establishes the idea of the emotional stem glass, which respects the uniqueness of each single wine and its own organoleptic sensations. For some time now, the company's attention for detail, high quality materials, professional and technical efficiency for products, as well as creativity line up with Italesse's awareness for ethics and the environmental concerns that surround us. At the end of 2019 EcoVadis, a prestigious international award relating to sustainability, rewarded the company's commitment for these themes with the silver medal.

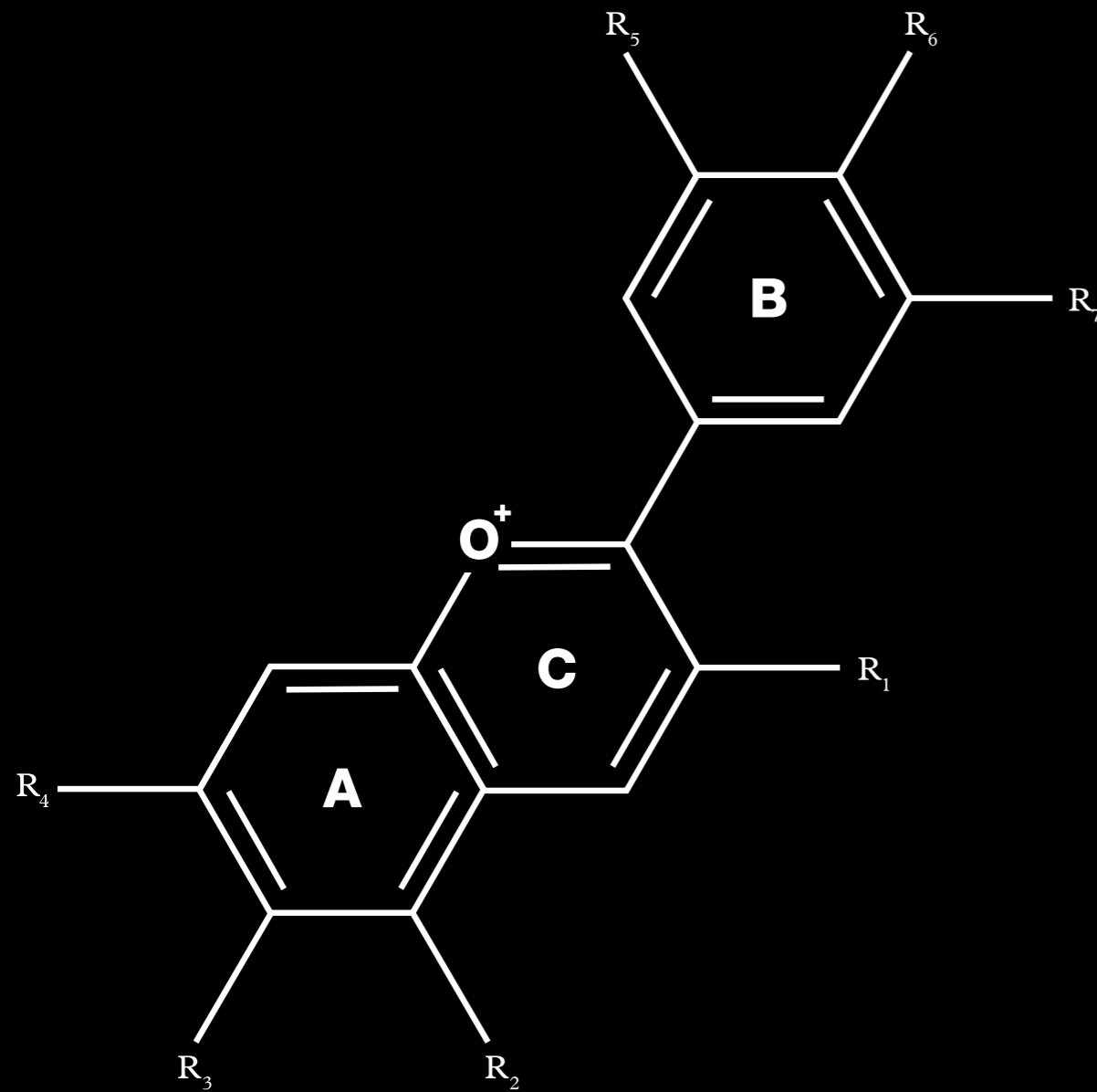

Indice / Contents

- 08 Calici e bicchieri in vetro /
Crystalline Stemware and Glasses
- 46 Calici e bicchieri in materiale plastico /
Plastic Stemware and Glasses
- 56 Caraffe /
Pitchers
- 57 Decanter /
Decanters
- 60 Secchielli e spumantiere /
Ice Buckets and Bowls
- 76 Vassoi /
Trays
- 77 Accessori /
Accessories
- 86 Designers
& Opinion Leaders



A photograph of four wine glasses filled with different types of wine, arranged on a dark wooden bar counter. The background is a blurred bar with shelves of bottles and warm lighting. The glasses from left to right contain: a dark red wine, a light yellow wine, a dark red wine, and a light yellow wine with a thick head of foam. The lighting is dramatic, highlighting the shapes of the glasses and the colors of the wine.

Italesse dà vita ai propri prodotti studiandone ogni dettaglio, traducendo la funzionalità in emozioni percepite attraverso il gusto e la vista. Know-how professionale e cultura del design guidano ogni atto creativo dell'azienda. | Italesse creates its products by studying every single detail, translating functionality into emotions perceived through taste and sight. Professional know-how and design culture lead every creative act of the company.

Calici e bicchieri in vetro / Crystalline Stemware and Glasses

Masterclass 90 Excellence

design by Italesse

art. 3367

MATERIALE / MATERIAL
Vetro cristallino Excellence
soffiato a bocca e lavorato
a mano / Excellence
mouth-blown hand-crafted
crystalline glass

CAPACITÀ / CAPACITY
950 cc / 32 oz



Clear

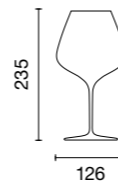

Masterclass 70 Excellence

design by Italesse

art. 3366

MATERIALE / MATERIAL
Vetro cristallino Excellence
soffiato a bocca e lavorato
a mano / Excellence
mouth-blown hand-crafted
crystalline glass

CAPACITÀ / CAPACITY
720 cc / 24 1/4 oz



Clear



Masterclass 48 Excellence

design by Italesse

art. 3365

MATERIALE / MATERIAL
Vetro cristallino Excellence
soffiato a bocca e lavorato
a mano / Excellence
mouth-blown hand-crafted
crystalline glass

CAPACITÀ / CAPACITY
480 cc / 16 1/4 oz



Clear



Masterclass XL 120 Excellence

design by Italesse

art. 3385

MATERIALE / MATERIAL
Vetro cristallino Excellence
soffiato a bocca e lavorato
a mano / Excellence
mouth-blown hand-crafted
crystalline glass

CAPACITÀ / CAPACITY
1200 cc / 40 1/2 oz



Clear



Masterclass XL 95 Excellence

design by Italesse

art. 3384

MATERIALE / MATERIAL
Vetro cristallino Excellence
soffiato a bocca e lavorato
a mano / Excellence
mouth-blown hand-crafted
crystalline glass

CAPACITÀ / CAPACITY
950 cc / 32 oz



Clear

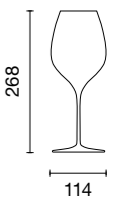

Masterclass XL 65 Excellence

design by Italesse

art. 3383

MATERIALE / MATERIAL
Vetro cristallino Excellence
soffiato a bocca e lavorato
a mano / Excellence
mouth-blown hand-crafted
crystalline glass

CAPACITÀ / CAPACITY
650 cc / 22 oz



Clear

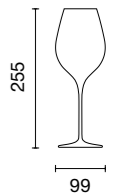

Masterclass Tumbler Excellence

design by Italesse

art. 3357

MATERIALE / MATERIAL
Vetro cristallino Excellence
soffiato a bocca e lavorato
a mano / Excellence
mouth-blown hand-crafted
crystalline glass

CAPACITÀ / CAPACITY
460 cc / 15 1/2 oz



Clear

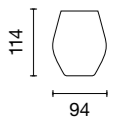



Masterclass Collection

Flûte che rievocano le forme dei calici da vino tradizionali balloon, realizzati per una proposta di servizio innovativo in linea con le nuove tendenze di degustazione e di consumo del mondo dello Champagne - scenico ed elegante | Flutes that evoke the silhouette of traditional wine tasting balloon glasses delivering an innovative proposal for service that follows the latest tasting and consumption trends in Champagne - dramatic, sophisticated

Masterclass 90

design by Italesse

art. 3364

MATERIALE / MATERIAL
**Vetro cristallino Xtreme® soffiato
 in automatico in assenza di piombo /
 Lead free automatically blown
 crystalline Xtreme® glass**

CAPACITÀ / CAPACITY
950 cc / 32 oz



Clear



Masterclass 70

design by Italesse

art. 3363

MATERIALE / MATERIAL
**Vetro cristallino Xtreme® soffiato
 in automatico in assenza di piombo /
 Lead free automatically blown
 crystalline Xtreme® glass**

CAPACITÀ / CAPACITY
720 cc / 24 ¼ oz



Clear



Masterclass 50

design by Italesse

art. 3375

MATERIALE / MATERIAL
**Vetro cristallino Xtreme® soffiato
 in automatico in assenza di piombo /
 Lead free automatically blown
 crystalline Xtreme® glass**

CAPACITÀ / CAPACITY
520 cc / 18 oz



Clear



Masterclass 48

design by Italesse

art. 3362

MATERIALE / MATERIAL
**Vetro cristallino Xtreme® soffiato
 in automatico in assenza di piombo /
 Lead free automatically blown
 crystalline Xtreme® glass**

CAPACITÀ / CAPACITY
480 cc / 16 ¼ oz



Clear

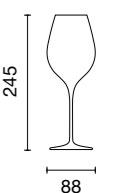

Etoilé Noir Excellence

design by Italesse

art. 3347

MATERIALE / MATERIAL
**Vetro cristallino Excellence
 soffiato a bocca e lavorato
 a mano / Excellence
 mouth-blown hand-crafted
 crystalline glass**

CAPACITÀ / CAPACITY
760 cc / 25 ¾



Clear



Etoilé Blanc Excellence

design by Italesse

art. 3346

MATERIALE / MATERIAL
**Vetro cristallino Excellence
 soffiato a bocca e lavorato
 a mano / Excellence
 mouth-blown hand-crafted
 crystalline glass**

CAPACITÀ / CAPACITY
550 cc / 18 ½ oz



Clear



Etoilé d'Or Excellence

design by Italesse

art. 3057

MATERIALE / MATERIAL
Vetro cristallino Excellence
 soffiato a bocca e lavorato
 a mano / Excellence
 mouth-blown hand-crafted
 crystalline glass

CAPACITÀ / CAPACITY
330 cc / 11 oz



Clear



Etoilé Platinum Excellence

design by Luca Bini

art. 3075

MATERIALE / MATERIAL
Vetro cristallino Excellence
 soffiato a bocca e lavorato
 a mano / Excellence
 mouth-blown hand-crafted
 crystalline glass

CAPACITÀ / CAPACITY
660 cc / 22 ¼ oz



Clear



Etoilé Sparkle Excellence

design by Luca Bini

art. 3062

MATERIALE / MATERIAL
Vetro cristallino Excellence
 soffiato a bocca e lavorato
 a mano / Excellence
 mouth-blown hand-crafted
 crystalline glass

CAPACITÀ / CAPACITY
480 cc / 16 ¼ oz



Clear

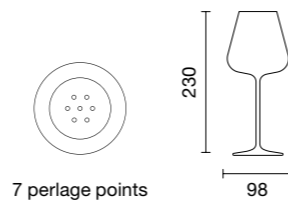

Etoilé Cristal Excellence

design by Italesse

art. 3348

MATERIALE / MATERIAL
Vetro cristallino Excellence
 soffiato a bocca e lavorato
 a mano / Excellence
 mouth-blown hand-crafted
 crystalline glass

CAPACITÀ / CAPACITY
400 cc / 13 ½ oz



Clear

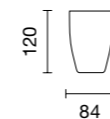

Etoilé Noir

design by Italesse, concept by Maîtres Cuisiniers de France

art. 3361

MATERIALE / MATERIAL
Vetro cristallino Xtreme®
 soffiato in automatico
 in assenza di piombo /
 Lead free automatically
 blown crystalline
 Xtreme® glass

CAPACITÀ / CAPACITY
790 cc / 26 ¾ oz



Clear



Etoilé Blanc

design by Italesse, concept by Maîtres Cuisiniers de France

art. 3360

MATERIALE / MATERIAL
Vetro cristallino Xtreme®
 soffiato in automatico
 in assenza di piombo /
 Lead free automatically
 blown crystalline
 Xtreme® glass

CAPACITÀ / CAPACITY
580 cc / 19 ¼ oz



Clear



Etoilé Sparkle

design by Luca Bini, concept by Maîtres Cuisiniers de France

art. 3055

MATERIALE / MATERIAL
Vetro cristallino Xtreme®
 soffiato in automatico
 in assenza di piombo /
 Lead free automatically
 blown crystalline
 Xtreme® glass

CAPACITÀ / CAPACITY
480 cc / 16 ¼ oz



Clear

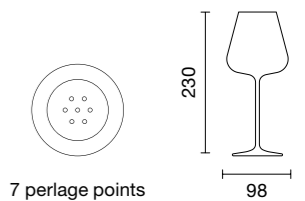

Etoilé Cristal

design by Italesse

art. 3359

MATERIALE / MATERIAL
Vetro / Glass

CAPACITÀ / CAPACITY
400 cc / 13 ½ oz



Clear



Black
Transparent



Red

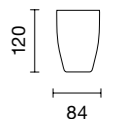

Wormwood Collection

Italesse presenta una collezione cocktail in grado di fondere un accattivante design in un prodotto tecnico e innovativo dedicato ai Bartender professionisti, ai Cocktail Bar premium e al mondo della Ospitalità | Italesse presents a cocktail collection that fuses an appealing design with a highly technical and innovative product concept dedicated to cocktail professionals, premium bars and the hospitality world

design by LUCA TRAZZI
concept by GIANCARLO MANCINO



Wormwood Gallone

design by Luca Trazzi, concept by Giancarlo Mancino

art. 1404

MATERIALE / MATERIAL
Vetro soffiato a bocca /
Mouth-blown glass

CAPACITÀ / CAPACITY
1000 cc / 33 ¼ oz



Clear

Pattern

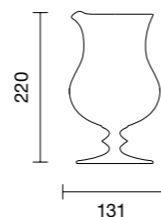

Wormwood Astoria

design by Luca Trazzi, concept by Giancarlo Mancino

art. 3371

MATERIALE / MATERIAL
Vetro cristallino /
Crystalline glass

CAPACITÀ / CAPACITY
130 cc / 4 ¼ oz



Clear

Pattern

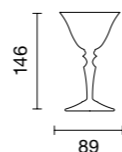

Wormwood Alto-Ball

design by Luca Trazzi, concept by Giancarlo Mancino

art. 3352

MATERIALE / MATERIAL
Vetro cristallino /
Crystalline glass

CAPACITÀ / CAPACITY
310 cc / 10 ½ oz



Clear

Pattern

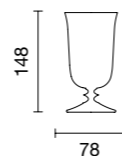

Wormwood Presidente

design by Luca Trazzi, concept by Giancarlo Mancino

art. 3370

MATERIALE / MATERIAL
Vetro cristallino /
Crystalline glass

CAPACITÀ / CAPACITY
135 cc / 4 ½ oz



Clear

Pattern

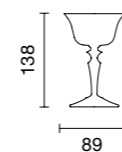

Wormwood Double Presidente

design by Luca Trazzi, concept by Giancarlo Mancino

art. 3372

MATERIALE / MATERIAL
Vetro cristallino /
Crystalline glass

CAPACITÀ / CAPACITY
220 cc / 7 ½ oz



Clear

Pattern

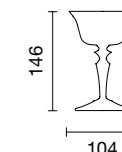

Wormwood Rock-Gobbler

design by Luca Trazzi, concept by Giancarlo Mancino

art. 3351

MATERIALE / MATERIAL
Vetro cristallino /
Crystalline glass

CAPACITÀ / CAPACITY
230 cc / 7 ¾ oz



Clear

Pattern

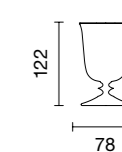

Wormwood Galante

design by Luca Trazzi, concept by Giancarlo Mancino

art. 3349

MATERIALE / MATERIAL
Vetro cristallino /
Crystalline glass

CAPACITÀ / CAPACITY
490 cc / 16 ½ oz



Clear

Pattern

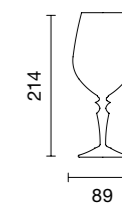

Wormwood Fizz

design by Luca Trazzi, concept by Giancarlo Mancino

art. 3038

MATERIALE / MATERIAL
Vetro cristallino /
Crystalline glass

CAPACITÀ / CAPACITY
260 cc / 8 ¾ oz



Pattern

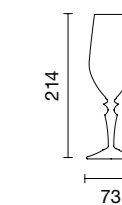

Tiburón Large

design by Italesse

art. 3340

MATERIALE / MATERIAL
Vetro cristallino Xtreme®
soffiato in automatico
in assenza di piombo /
Xtreme® crystalline
automatic blown glass
with no lead

CAPACITÀ / CAPACITY
620 cc / 21 oz



Clear

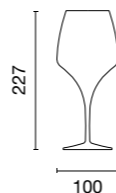

Tiburón Medium

design by Italesse

art. 3341

MATERIALE / MATERIAL
Vetro cristallino Xtreme®
soffiato in automatico
in assenza di piombo /
Xtreme® crystalline
automatic blown glass
with no lead

CAPACITÀ / CAPACITY
500 cc / 16 ¾ oz



Clear



Tiburón Gran Cru

design by Italesse

art. 3053

MATERIALE / MATERIAL
Vetro cristallino Xtreme®
soffiato in automatico
in assenza di piombo /
Xtreme® crystalline
automatic blown glass
with no lead

CAPACITÀ / CAPACITY
380 cc / 12 ¾ oz



Clear

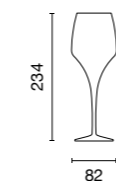

Tiburón Tumbler

design by Italesse

art. 3342

MATERIALE / MATERIAL
Vetro colorato soffiato
a bocca e lavorato
a mano / Mouth-blown,
hand-crafted coloured
glass

CAPACITÀ / CAPACITY
350 cc / 11 ¾ oz



White

Black
Transparent

Red

Violet

Blue

Orange

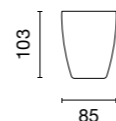

Vertical Large

design by Italesse

art. 3304

MATERIALE / MATERIAL
Vetro cristallino Xtreme®
soffiato in automatico
in assenza di piombo /
Xtreme® Crystalline
automatic blown glass
with no lead

CAPACITÀ / CAPACITY
500 cc / 16 ¾ oz



Clear

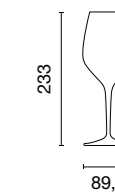

Vertical Medium

design by Italesse

art. 3308

MATERIALE / MATERIAL
Vetro cristallino Xtreme®
soffiato in automatico
in assenza di piombo /
Xtreme® Crystalline
automatic blown glass
with no lead

CAPACITÀ / CAPACITY
390 cc / 13 oz



Clear

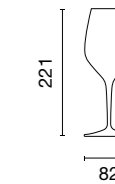

Privè Gran Cru

design by Italesse

art. 3049

MATERIALE / MATERIAL
Vetro cristallino Xtreme®
soffiato in automatico
in assenza di piombo /
Xtreme® Crystalline
automatic blown glass
with no lead

CAPACITÀ / CAPACITY
330 cc / 11 oz



Clear

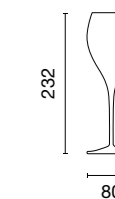

Privè Flûte

design by Italesse

art. 3048

MATERIALE / MATERIAL
Vetro cristallino Xtreme®
soffiato in automatico
in assenza di piombo /
Xtreme® Crystalline
automatic blown glass
with no lead

CAPACITÀ / CAPACITY
150 cc / 5 oz



Clear

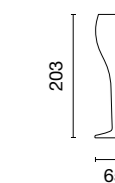

Vertical Party

design by Italesse

art. 3310

MATERIALE / MATERIAL
Vetro cristallino soffiato
in automatico in assenza
di piombo / Crystalline
automatic blown glass
with no lead

CAPACITÀ / CAPACITY
420 cc / 14 ¼ oz



Clear

White

Red

Blue

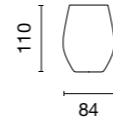

Bora Large

design by Italesse

art. 3323

MATERIALE / MATERIAL
Vetro / Glass

CAPACITÀ / CAPACITY
500 cc / 16 ¾ oz



Clear

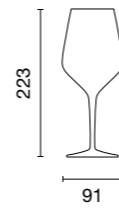

Bora Medium

design by Italesse

art. 3324

MATERIALE / MATERIAL
Vetro / Glass

CAPACITÀ / CAPACITY
390 cc / 13 oz



Clear

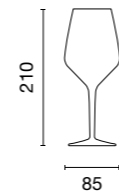

Bora Flûte

design by Italesse

art. 3054

MATERIALE / MATERIAL
Vetro / Glass

CAPACITÀ / CAPACITY
280 cc / 9 ½ oz



Clear



Easy Big

design by Italesse

art. 3322

MATERIALE / MATERIAL
Vetro / Glass

CAPACITÀ / CAPACITY
760 cc / 25 ¾ oz



Clear



Easy Large Plus

design by Italesse

art. 3368

MATERIALE / MATERIAL
Vetro / Glass

CAPACITÀ / CAPACITY
500 cc / 16 ¾ oz



Clear

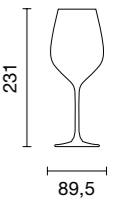

Easy Large

design by Italesse

art. 3321

MATERIALE / MATERIAL
Vetro / Glass

CAPACITÀ / CAPACITY
500 cc / 16 ¾ oz



Clear

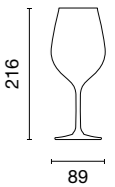

Easy Medium

design by Italesse

art. 3320

MATERIALE / MATERIAL
Vetro / Glass

CAPACITÀ / CAPACITY
380 cc / 12 ¾ oz



Clear

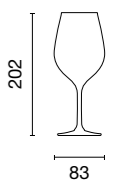

Balloon Line

Flûte che rievocano le forme dei calici da vino tradizionali balloon, realizzati per una proposta di servizio innovativo in linea con le nuove tendenze di degustazione e di consumo del mondo dello Champagne - scenico ed elegante | Flutes that evoke the silhouette of traditional wine tasting balloon glasses delivering an innovative proposal for service that follows the latest tasting and consumption trends in Champagne - dramatic, sophisticated

Master

design by Italesse

art. 3309

MATERIALE / MATERIAL
Vetro / Glass

CAPACITÀ / CAPACITY
290 cc / 9 ¾ oz



Clear



Dolcevita

design by Italesse

art. 3374

MATERIALE / MATERIAL
Vetro / Glass

CAPACITÀ / CAPACITY
470 cc / 15 ¾ oz



Clear



Mastro

design by Italesse

art. 3369

MATERIALE / MATERIAL
Vetro / Glass

CAPACITÀ / CAPACITY
420 cc / 14 ¼ oz



Clear



Balloon Magnum Flûte

design by Italesse

art. 3037

MATERIALE / MATERIAL
Vetro cristallino Excellence
soffiato a bocca e lavorato
a mano / Excellence
mouth-blown hand-crafted
crystalline glass

CAPACITÀ / CAPACITY
450 cc / 15 ¼ oz



Clear

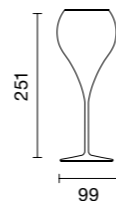

Grand Balloon Flûte

design by Italesse

art. 3036

MATERIALE / MATERIAL
Vetro Xtreme® soffiato
in automatico in assenza
di piombo / Automatically
blown, lead free Xtreme®
glass

CAPACITÀ / CAPACITY
380 cc / 12 ¾ oz



Clear

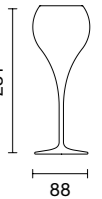

Balloon Flûte

design by Italesse

art. 3035

MATERIALE / MATERIAL
Vetro Xtreme® soffiato
in automatico in assenza
di piombo / Automatically
blown, lead free Xtreme®
glass

CAPACITÀ / CAPACITY
210 cc / 7 oz



Clear

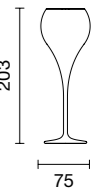

Richard Juhlin Optimum

design by Claesson Koivisto Rune, concept by Richard Juhlin

art. 3056

MATERIALE / MATERIAL
Vetro cristallino /
Crystalline glass

CAPACITÀ / CAPACITY
290 cc / 9 ¾ oz



Clear



With Juhlin Line

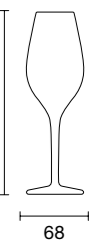

Flûte N°5

design by Italesse

art. 3059

MATERIALE / MATERIAL
Vetro cristallino Xtreme®
soffiato in automatico
in assenza di piombo /
Xtreme® Crystalline
automatic blown glass
with no lead

CAPACITÀ / CAPACITY
280 cc / 9 ½ oz



Clear



Pua Tumbler

Un tumbler dal design unico, allo stesso tempo dinamico e raffinato | A tumbler with a unique design, dynamic and sophisticated at the same time

design by ITALESSE



Tester 16

design by Italesse

art. 3047

MATERIALE / MATERIAL
Vetro / Glass

CAPACITÀ / CAPACITY
160 cc



Clear



Riviera 17

design by Italesse

art. 3070

MATERIALE / MATERIAL
Vetro / Glass

CAPACITÀ / CAPACITY
170 cc / 5 ¾ oz



Clear

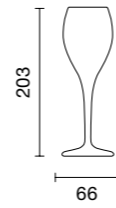

Riviera 16

design by Italesse

art. 3069

MATERIALE / MATERIAL
Vetro / Glass

CAPACITÀ / CAPACITY
160 cc / 5 ½ oz



Clear

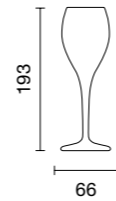

Riviera 14

design by Italesse

art. 3068

MATERIALE / MATERIAL
Vetro / Glass

CAPACITÀ / CAPACITY
140 cc / 4 ¾ oz



Clear

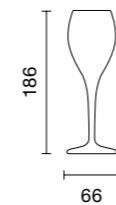

Pua

design by Italesse

art. 3354

MATERIALE / MATERIAL
Vetro borosilicato soffiato
a bocca, lavorato a mano /
Mouth-blown hand-crafted
borosilicate glass

CAPACITÀ / CAPACITY
370 cc / 12 ½ oz



Clear
& White

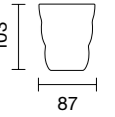

Mares Tumbler

design by Italesse

art. 3355

MATERIALE / MATERIAL
Pasta di vetro colorato
soffiato a bocca e lavorato
a mano / Hand-crafted
mouth-blown colored
glass paste

CAPACITÀ / CAPACITY
310 cc / 10 ½ oz



Angel
Fish

Tiger
Fish

Star
Fish

Napoleon
Fish

Jelly
Fish

Clown
Fish



Argus
Fish

Parrot
Fish

Shell
Fish

Sea Bass
Fish

Bluefin
Fish

Oyster
Fish

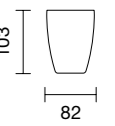

Mares Tumbler Shot

design by Italesse

art. 3356

MATERIALE / MATERIAL
Pasta di vetro colorato
soffiato a bocca e lavorato
a mano / Hand-crafted
mouth-blown colored
glass paste

CAPACITÀ / CAPACITY
53 cc / 1 ¾ oz



Napoleon
Fish

Clown
Fish

Star
Fish

Shell
Fish

Parrot
Fish

Oyster
Fish

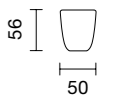

Mares Collection

Nata per stupire e realizzata a mano da mastri vetrai orientali, la linea Mares è composta da coloratissimi bicchieri, shot e bowl creati con una tecnica produttiva che ha radici antiche | Hand Made by oriental glassware craftsmen to astonish and surprise, the Mares items are extremely colourful glasses, shots and bowls produced using manual manufacturing techniques with ancient roots

design by ITALESSE



Vertigo Tumbler

Classe ed eleganza nella lavorazione artistica del vetro soffiato colorato / Elegance and class in the artistic craftsmanship of mouth-blown colored glass

design by ITALESSE



Mares Bowl N.11

design by Italesse

art. 5082

MATERIALE / MATERIAL

**Pasta di vetro colorato
soffiato a bocca e lavorato
a mano / Hand-crafted
mouth-blown colored
glass paste**

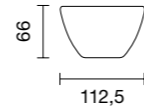

Mares Bowl N.8

design by Italesse

art. 5081

MATERIALE / MATERIAL

**Pasta di vetro colorato
soffiato a bocca e lavorato
a mano / Hand-crafted
mouth-blown colored
glass paste**

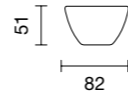

Vertigo Tumbler

design by Italesse

art. 3353

MATERIALE / MATERIAL

**Vetro colorato soffiato
a bocca e lavorato
a mano / Mouth-blown,
hand-crafted coloured
glass**

CAPACITÀ / CAPACITY
380 cc / 12 ¾ oz

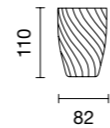

Bolle Tumbler

design by Luca Trazzi

art. 3350

MATERIALE / MATERIAL

**Vetro colorato lavorato a mano /
Colored hand-crafted glass**

CAPACITÀ / CAPACITY
340 cc / 11 ½ oz

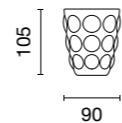

Dixie Tumbler

design by Italesse

art. 0038

MATERIALE / MATERIAL

Vetro / Glass

CAPACITÀ / CAPACITY
360 cc / 12 oz



Clear

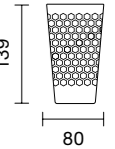

Dixie Tumbler Small

design by Italesse

art. 0039

MATERIALE / MATERIAL

Vetro / Glass

CAPACITÀ / CAPACITY
310 cc / 10 ½ oz



Clear

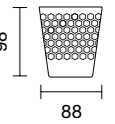

Shabby 34

art. 0042

MATERIALE / MATERIAL

Vetro / Glass

CAPACITÀ / CAPACITY
340 cc / 11 ½ oz



Clear

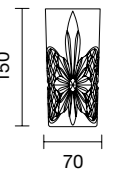

Shabby 31

art. 0041

MATERIALE / MATERIAL

Vetro / Glass

CAPACITÀ / CAPACITY
310 cc / 10 ½ oz



Clear

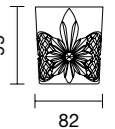

Bolle Tumbler

Prodotti in pasta di vetro colorata, Bolle Tumbler e Bolle Pitcher sono caratterizzati da un design sinuoso e da vivaci giochi di luce / Made of coloured glass paste, Bolle Tumbler and Bolle Pitcher are characterized by a sinuous design that creates lively plays of light

design by LUCA TRAZZI



Tonic Glass

design by Claesson Koivisto Rune

art. 3318

MATERIALE / MATERIAL

Vetro / Glass

CAPACITÀ / CAPACITY

400 cc / 13 ½ oz



Clear

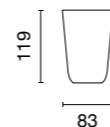

Tonic Glass Small

design by Claesson Koivisto Rune

art. 3317

MATERIALE / MATERIAL

Vetro / Glass

CAPACITÀ / CAPACITY

290 cc / 9 ¾ oz



Clear

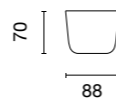

Sfera N.11

design by Minedivine

art. 3330

MATERIALE / MATERIAL

Vetro borosilicato soffiato a bocca, lavorato a mano e gomma soffice colorata base / Mouth-blown hand-crafted borosilicate glass and soft-coloured rubber base

CAPACITÀ / CAPACITY

580 cc / 19 ¾ oz



Clear-white

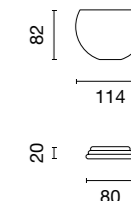

Sfera N.9

design by Italesse

art. 3333

MATERIALE / MATERIAL

Vetro borosilicato soffiato a bocca, lavorato a mano / Mouth-blown hand-crafted borosilicate glass

CAPACITÀ / CAPACITY

295 cc / 10 oz



Clear

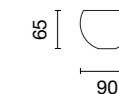

Sfera N.7

design by Italesse

art. 3332

MATERIALE / MATERIAL

Vetro borosilicato soffiato a bocca, lavorato a mano / Mouth-blown hand-crafted borosilicate glass

CAPACITÀ / CAPACITY

120 cc / 4 oz



Clear

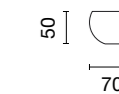

Sfera N.5

design by Italesse

art. 3331

MATERIALE / MATERIAL

Vetro borosilicato soffiato a bocca, lavorato a mano / Mouth-blown hand-crafted borosilicate glass

CAPACITÀ / CAPACITY

70 cc / 2 ¼ oz



Clear

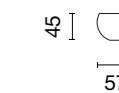

Sfera

Bicchieri multiuso in vetro con base in gomma colorata utile alla gestione dell'inclinazione per un servizio fantasioso / Multi-purpose glass with a colored rubber base on which to tilt the glass for a creative service

design by MINEDIVINE



Go-Go

design by Italesse

art. 3319

MATERIALE / MATERIAL
**Vetro cristallino soffiato
 in automatico in assenza
 di piombo / Crystalline
 automatic blown glass
 with no lead**

CAPACITÀ / CAPACITY
580 cc / 19 ¾ oz



Clear

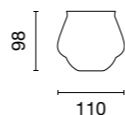

Go-Go Small

design by Italesse

art. 3328

MATERIALE / MATERIAL
**Vetro cristallino soffiato
 in automatico in assenza
 di piombo / Crystalline
 automatic blown glass
 with no lead**

CAPACITÀ / CAPACITY
320 cc / 10 ¾ oz



Clear

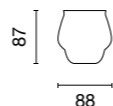

Premium Martini

design by Italesse

art. 0034

MATERIALE / MATERIAL
**Vetro cristallino soffiato
 in automatico in assenza
 di piombo / Crystalline
 automatic blown glass
 with no lead**

CAPACITÀ / CAPACITY
240 cc / 7 oz



Clear

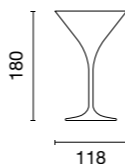

Premium Tumbler Large

design by Italesse

art. 0030

MATERIALE / MATERIAL
**Vetro cristallino soffiato
 in automatico in assenza
 di piombo / Crystalline
 automatic blown glass
 with no lead**

CAPACITÀ / CAPACITY
465 cc / 15 ¾ oz



Clear

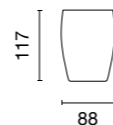

Premium Tumbler

design by Italesse

art. 0025

MATERIALE / MATERIAL
**Vetro cristallino soffiato
 in automatico in assenza
 di piombo / Crystalline
 automatic blown glass
 with no lead**

CAPACITÀ / CAPACITY
345 cc / 14 ¾ oz



Clear

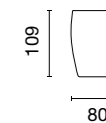

Premium Hi-Ball Large

design by Italesse

art. 0033

MATERIALE / MATERIAL
**Vetro cristallino soffiato
 in automatico in assenza
 di piombo / Crystalline
 automatic blown glass
 with no lead**

CAPACITÀ / CAPACITY
435 cc / 15 ¾ oz



Clear

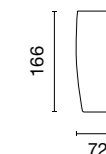

Premium Hi-Ball

design by Italesse

art. 0032

MATERIALE / MATERIAL
**Vetro cristallino soffiato
 in automatico in assenza
 di piombo / Crystalline
 automatic blown glass
 with no lead**

CAPACITÀ / CAPACITY
310 cc / 10 ½ oz



Clear

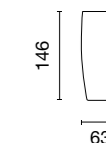

Premium Shot

design by Italesse

art. 0031

MATERIALE / MATERIAL
**Vetro cristallino soffiato
 in automatico in assenza
 di piombo / Crystalline
 automatic blown glass
 with no lead**

CAPACITÀ / CAPACITY
72 cc / 2 ½ oz



Clear

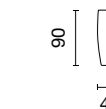

Calici e bicchieri in materiale plastico / Plastic Stemware and Glasses

Bolle Beach Tumbler

design by Luca Trazzi

art. 3941

MATERIALE / MATERIAL
Polycrystal®

CAPACITÀ / CAPACITY
350 cc / 11 ¾ oz



Clear

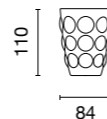

Fresnel Wine

design by Luca Nichetto

art. 3946

MATERIALE / MATERIAL
Polycrystal®

CAPACITÀ / CAPACITY
330 cc / 11 oz



Clear



Fresnel Flûte

design by Luca Nichetto

art. 3947

MATERIALE / MATERIAL
Polycrystal®

CAPACITÀ / CAPACITY
200 cc / 6 ¾ oz



Clear



Fresnel Party

design by Luca Nichetto

art. 3948

MATERIALE / MATERIAL
Polycrystal®

CAPACITÀ / CAPACITY
360 cc / 12 oz



Clear

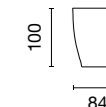

Tonic Beach Large

design by Claesson Koivisto Rune

art. 3903

MATERIALE / MATERIAL
Polycrystal®

CAPACITÀ / CAPACITY
500 cc / 16 ¾ oz



White
Frost

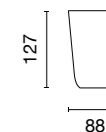

Tonic Beach Medium

design by Claesson Koivisto Rune

art. 3902

MATERIALE / MATERIAL
Polycrystal®

CAPACITÀ / CAPACITY
350 cc / 11 ¾ oz



White
Frost

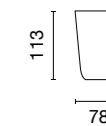

Pachà Beach Light Large

design by Italesse

art. 3901

MATERIALE / MATERIAL
**Polipropilene /
Polypropylene**

CAPACITÀ / CAPACITY
500 cc / 16 ¾ oz



White
Frost

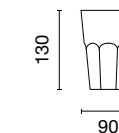

Beach Collection

Una proposta di calici e bicchieri perfetti in ambienti outdoor per un servizio glamour in piena sicurezza | A collection of stemware and tumblers perfect for outdoor environments, for glamorous service in complete safety

design by ITALESSE



Pachà Beach Light Medium

design by Italesse

art. 3900

MATERIALE / MATERIAL

**Polipropilene /
Polypropylene**

CAPACITÀ / CAPACITY

400 cc / 13 ½ oz



**White
Frost**

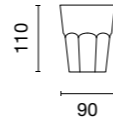

Brew Beach 40

design by Italesse

art. 3917

MATERIALE / MATERIAL

Policrystal®

CAPACITÀ / CAPACITY

500 cc / 17 oz



Clear

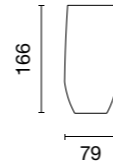

Brew Beach 33

design by Italesse

art. 3916

MATERIALE / MATERIAL

Policrystal®

CAPACITÀ / CAPACITY

450 cc / 15 ¼ oz



Clear



Martini Beach

design by Italesse

art. 3945

MATERIALE / MATERIAL

Policrystal®

CAPACITÀ / CAPACITY

270 cc / 9 oz



Clear

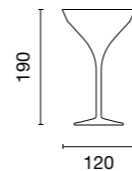

Vertical Beach

design by Italesse

art. 3930

MATERIALE / MATERIAL

Policrystal®

CAPACITÀ / CAPACITY

330 cc / 11 oz



Clear



Vertical Party Beach

design by Italesse

art. 3935

MATERIALE / MATERIAL

Policrystal®

CAPACITÀ / CAPACITY

420 cc / 14 ¼ oz



Clear



White



Red



Blue

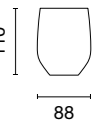

Privè Beach

design by Italesse

art. 3920

MATERIALE / MATERIAL

SAN / Policrystal®

CAPACITÀ / CAPACITY

130 cc / 4 ¼ oz



Clear



White

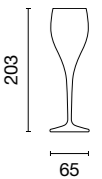

Moonlight Beach

design by Italesse

art. 3931

MATERIALE / MATERIAL

SAN / Policrystal®

CAPACITÀ / CAPACITY

410 cc / 13 ¾ oz



Clear



White

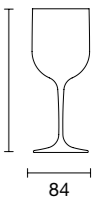

Sunlight Beach

design by Italesse

art. 3922

MATERIALE / MATERIAL
SAN / Polycrystal®

CAPACITÀ / CAPACITY
330 cc / 11 ¼ oz



Clear White



Air Beach Wine

design by Italesse

art. 0050

MATERIALE / MATERIAL
Tritan™ soffiato in automatico /
Automatic blown Tritan™

CAPACITÀ / CAPACITY
475 cc / 16 oz



Clear White



Air Beach Flûte 20

design by Italesse

art. 0063

MATERIALE / MATERIAL
Tritan™ soffiato in automatico /
Automatic blown Tritan™

CAPACITÀ / CAPACITY
200 cc / 6 ¾ oz



Clear



Air Beach G&T

design by Italesse

art. 0048

MATERIALE / MATERIAL
Tritan™ soffiato in automatico /
Automatic blown Tritan™

CAPACITÀ / CAPACITY
700 cc / 23 ¾ oz



Clear

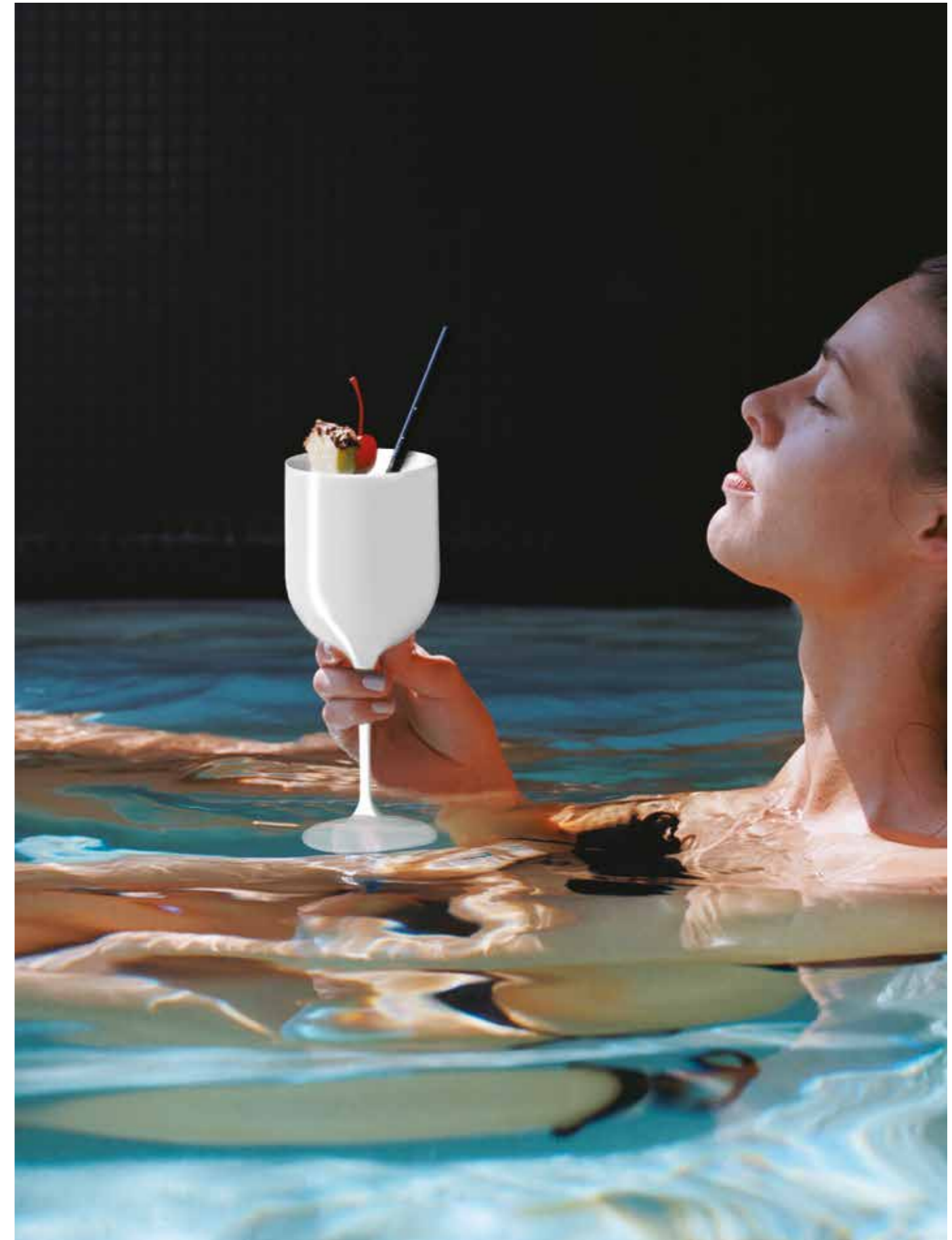
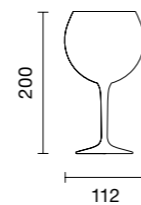

Vertigo Decanter

*Il design a spirale si unisce alla ricercatezza del vetro soffiato a bocca e lavorato a mano nel nuovo Vertigo Decanter /
The spiraling design meets the sophistication of mouth-blown and handcrafted glass in Vertigo Decanter*

design by ITALESSE



Caraffe / Pitchers

Vas

design by Todd Bracher

art. 1425

MATERIALE / MATERIAL
Vetro soffiato a bocca
e lavorato a mano,
materiale plastico tappo /
Mouth-blown and
hand-crafted glass,
plastic stopper

CAPACITÀ / CAPACITY
1000 cc / 33 ¾ oz



Clear

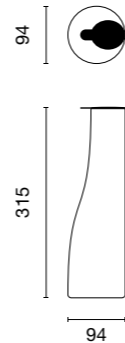

Bolle Pitcher

design by Luca Trazzi

art. 1410

MATERIALE / MATERIAL
Vetro lavorato a mano /
Hand-crafted glass

CAPACITÀ / CAPACITY
1200 cc / 40 ½ oz



Clear

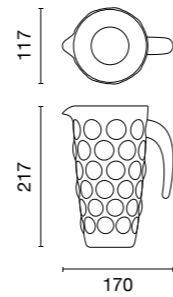

Decanter / Decanters

Vertigo Decanter

design by Italesse

art. 1355

MATERIALE / MATERIAL
Vetro soffiato a bocca,
lavorato a mano / Mouth-blown
hand-crafted glass

CAPACITÀ / CAPACITY
1500 cc / 50 ¾ oz



Clear

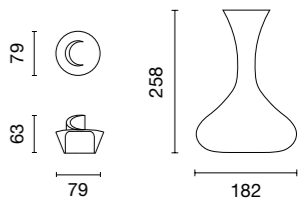

Vinocchio

design by Federico Venier

art. 1335

MATERIALE / MATERIAL
Vetro soffiato a bocca,
lavorato a mano decanter
e acrilico base / Mouth-blown
hand-crafted glass decanter
and acrylic base

CAPACITÀ / CAPACITY
1500 cc / 50 ¾ oz



Clear

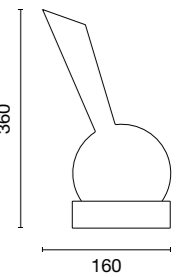

Set Alavin

design by Federico Venier

art. 1345

MATERIALE / MATERIAL
Vetro soffiato a bocca,
lavorato a mano decanter
e acrilico-silicone base /
Mouth-blown hand-crafted
glass decanter
and acrylic-silicone base

CAPACITÀ / CAPACITY
1700 cc / 57 ½ oz



Clear

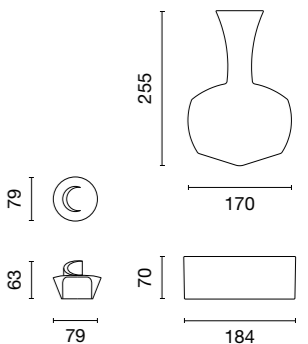

Vinocchio

Decanter in vetro soffiato dalle caratteristiche altamente professionali e dallo stile contemporaneo | Mouth-blown glass decanter with highly professional features and a contemporary style

design by FEDERICO VENIER



Secchielli e spumantiere / Ice Buckets and Bowls

Timber Bucket

design by Italesse

art. 1592

MATERIALE / MATERIAL
Eco Wood



Naturale

Esotico

Carbone

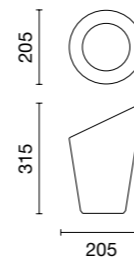

Timber Bowl

design by Italesse

art. 1618

MATERIALE / MATERIAL
Eco Wood



Naturale

Esotico



Esotico

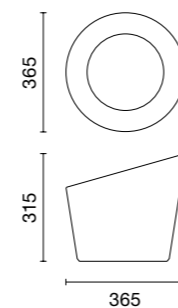

Plaza Bowl

design by Luca Trazzi

art. 1616

MATERIALE / MATERIAL
Acrilico / Acrylic



Clear

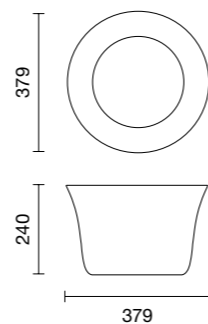

Large Round LED Base

design by Italesse

art. 6013

MATERIALE / MATERIAL
ABS



White

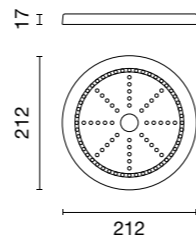

Plaza Bucket

design by Luca Trazzi

art. 1584

MATERIALE / MATERIAL
Acrilico / Acrylic



Clear

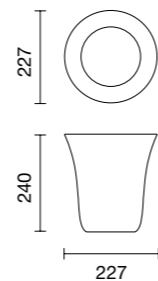

Small Round LED Base

design by Italesse

art. 6012

MATERIALE / MATERIAL
ABS



White

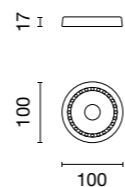

Tonic Ice Bucket

design by Claesson Koivisto Rune

art. 1588

MATERIALE / MATERIAL
Acrilico / Acrylic



Clear

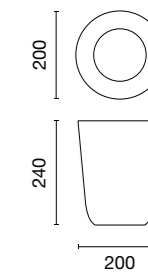

Small Round LED Base

design by Italesse

art. 6012

MATERIALE / MATERIAL
ABS



White

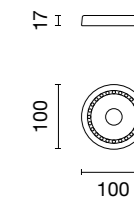

Tonic Ice Bowl

design by Claesson Koivisto Rune

art. 1614

MATERIALE / MATERIAL
Acrilico / Acrylic



Clear

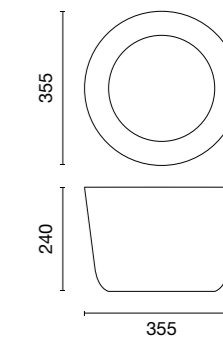

Large Round LED Base

design by Italesse

art. 6013

MATERIALE / MATERIAL
ABS



White

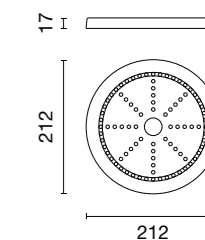

Plaza Bucket & Bowl

*Un design all'avanguardia con una superficie sfaccettata che richiama il classico taglio del cristallo, il secchiello e la spumantiera Plaza catturano l'attenzione con un brillante gioco di luci |
A pioneering design with a textured surface that evokes traditional cut crystal, the Plaza Bucket and Bowl draw your attention with its brilliant plays of light*

design by LUCA TRAZZI



Winston Bucket Large

design by Italesse

art. 1708

MATERIALE / MATERIAL
Stainless steel



Inox

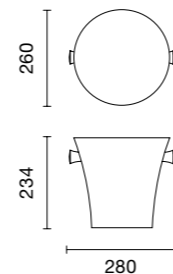

Winston Bucket

design by Italesse

art. 1707

MATERIALE / MATERIAL
Stainless steel



Inox

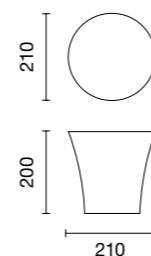

Nevada Bowl

design by Italesse

art. 1709

MATERIALE / MATERIAL
Stainless steel



Inox

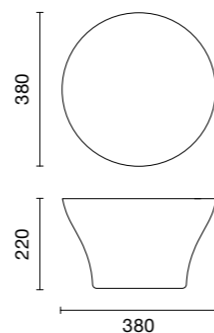

Vela Bucket

design by Italesse

art. 1583

MATERIALE / MATERIAL
Acrilico / Acrylic



Clear



White

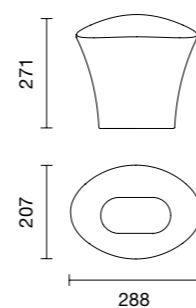

Small Oval LED Base

design by Italesse

art. 6016

MATERIALE / MATERIAL
ABS



Vela Bowl

design by Italesse

art. 1615

MATERIALE / MATERIAL
Acrilico / Acrylic



Large Oval LED Base

design by Italesse

art. 6017

MATERIALE / MATERIAL
ABS



Solomon Bucket

design by Carlos Tiscar

art. 1585

MATERIALE / MATERIAL
Acrilico / Acrylic



Vela Bucket Round

design by Italesse

art. 1589

MATERIALE / MATERIAL
Acrilico / Acrylic



Small Round LED Base

design by Italesse

art. 6012

MATERIALE / MATERIAL
ABS



Bolle Bucket & Bowl

Vere icone della collezione Italesse, il secchiello e la spumantiera Bolle sono interamente ricoperte da sfere di materiale acrilico trasparente, che le rendono luminose ed eleganti | Icons in Italesse's collection, Bolle Bucket and Bowl are completely covered with clear acrylic spheres, which make them extremely bright and elegant

design by LUCA TRAZZI



Vela Bowl Round

design by Italesse

art. 1617

MATERIALE / MATERIAL
Acrilico / Acrylic



Clear

White



Black

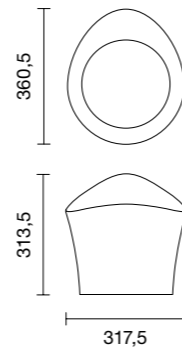

Large Round LED Base

design by Italesse

art. 6013

MATERIALE / MATERIAL
ABS



White

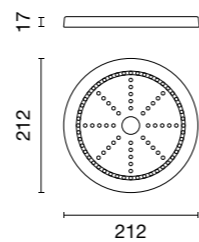

Bolle Bucket

design by Luca Trazzi

art. 1586

art. 1587 - Bolle Bucket Pro*

MATERIALE / MATERIAL
Acrilico / Acrylic



Clear

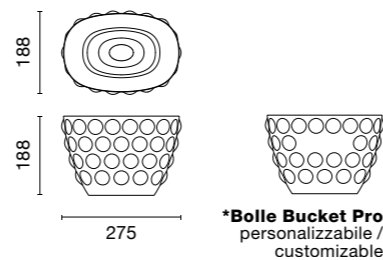

*Bolle Bucket Pro
personalizzabile /
customizable

Bolle Bowl

design by Luca Trazzi

art. 1612

art. 1613 - Bolle Bowl Pro*

MATERIALE / MATERIAL
Acrilico / Acrylic



Clear

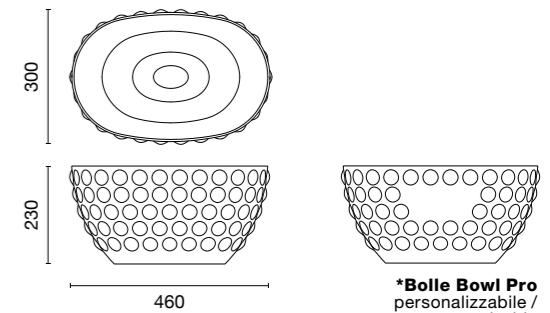

*Bolle Bowl Pro
personalizzabile /
customizable

Pagoda Bucket

design by Federico Venier

art. 1545

MATERIALE / MATERIAL
Acrilico / Acrylic



Clear

Black

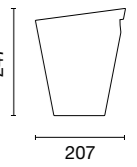

Pagoda Bucket Mirror

design by Federico Venier

art. 1700

MATERIALE / MATERIAL
Inox



Inox

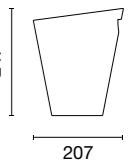

Gran Pagoda Bowl

design by Federico Venier

art. 1610

MATERIALE / MATERIAL
Acrilico / Acrylic

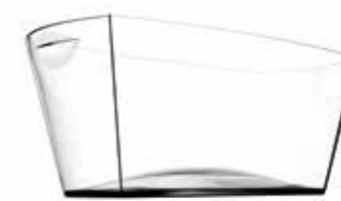

Clear



Black

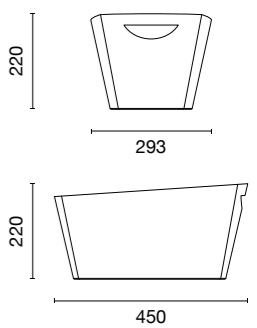

Bongo Bucket

design by Minedivine

art. 1562

MATERIALE / MATERIAL

Acrilico / Acrylic



Clear

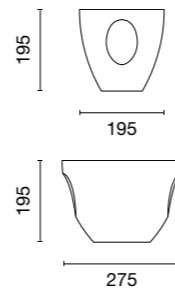

Bongo Bowl

design by Minedivine

art. 1630

MATERIALE / MATERIAL

Acrilico / Acrylic



Clear

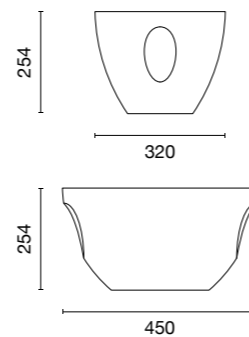

Easy Bucket Oval

design by Federico Venier

art. 1580

MATERIALE / MATERIAL

Acrilico / Acrylic



Clear



White

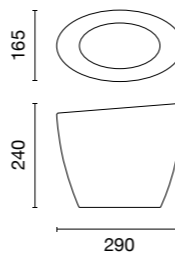

Easy Bowl Oval

design by Federico Venier

art. 1609

MATERIALE / MATERIAL

Acrilico / Acrylic



Clear



White

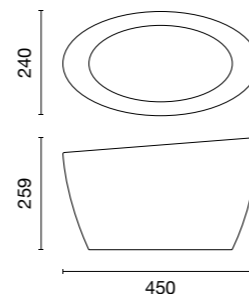

Easy Bucket Square

design by Federico Venier

art. 1578

MATERIALE / MATERIAL

Acrilico / Acrylic



Clear



Black

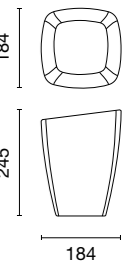

Easy Bowl Square

design by Federico Venier

art. 1607

MATERIALE / MATERIAL

Acrilico / Acrylic



Clear



Black

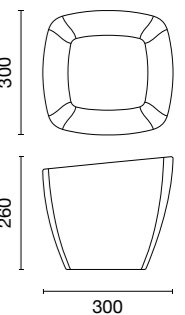

Easy Bucket Round

design by Federico Venier

art. 1574

MATERIALE / MATERIAL

Acrilico / Acrylic



Clear



Black

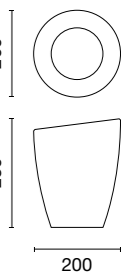

Easy Bowl Round

design by Federico Venier

art. 1605

MATERIALE / MATERIAL

Acrilico / Acrylic



Clear



Black

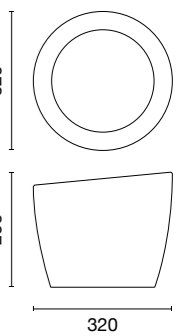

Vassoi / Trays

Stripe

design by Luca Nichetto

art. 6035

MATERIALE / MATERIAL
ABS



Black

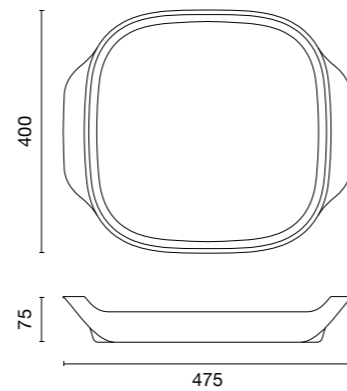

Accessori / Accessories

Aria

design by La Scena

art. 1900

MATERIALE / MATERIAL
Acrilico / Acrylic

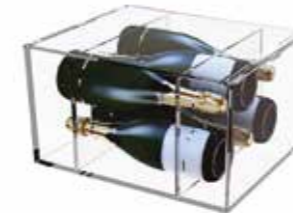

Clear

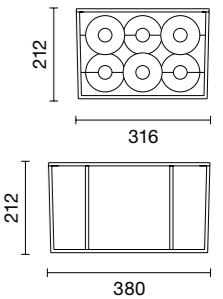

Wine 360° Set

design by Wine Revolution

art. 1907

MATERIALE / MATERIAL
Colonna: plexiglass. Ampolla: vetro
Column: plexiglass. Flask: glass



Clear

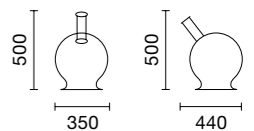
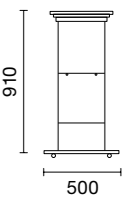
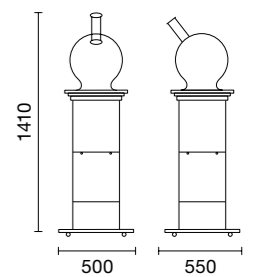

Wine 360° Desk

design by Wine Revolution

art. 1911

MATERIALE / MATERIAL

Ampolla: vetro. Base: Acrilico /
Flask: glass. Base: Acrylic



Clear

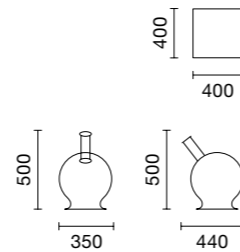

Venti4 Oval Cross

design by Luca Nichetto

art. 5053

MATERIALE / MATERIAL

Melamina / Melamine



White

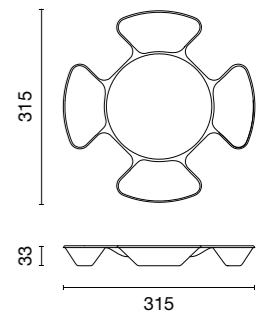

Venti4 Square Cross

design by Luca Nichetto

art. 5054

MATERIALE / MATERIAL

Melamina / Melamine



White

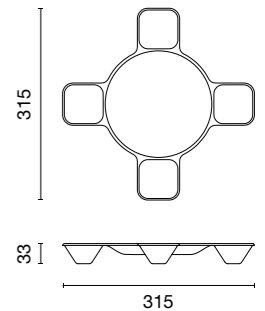

Venti4 Small Cup

design by Luca Nichetto

art. 5052

MATERIALE / MATERIAL

Melamina / Melamine



White

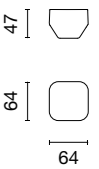

Bolle Cake Stand and Dome

design by Luca Trazzi

art. 5080

art. 5090

MATERIALE / MATERIAL

Vetro lavorato a mano /
Hand-crafted glass cake stand
SAN dome



Clear

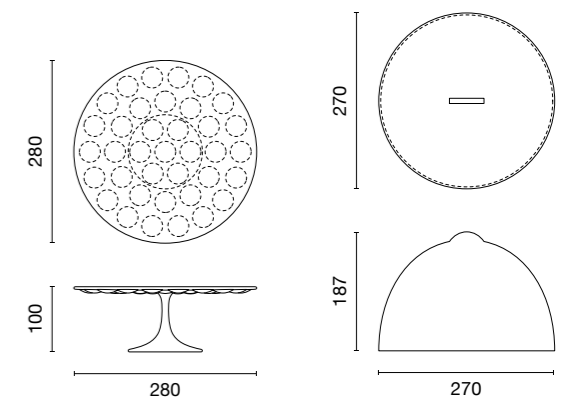

Bolle Cake Stand

L'alzatina Bolle Cake Stand di Italesse cattura l'occhio in qualsiasi contesto e diventa elemento centrale su qualsiasi tavola per l'originale gioco di bolle ad incastro | A unique and polyvalent cake stand that catches the eye in every context and becomes central feature of every table for its original play on light

design by LUCA TRAZZI



Set Pebble

design by Nendo

art. 5070 - Mixed Colors
art. 5072 - Black

MATERIALE / MATERIAL
Melamina / Melamine

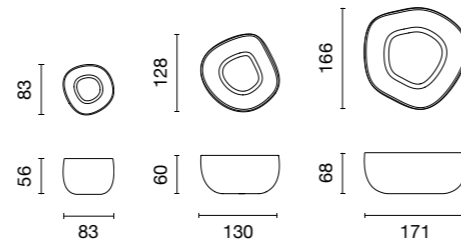

Pebble Large

design by Nendo

art. 5062

MATERIALE / MATERIAL
Melamina / Melamine



Black

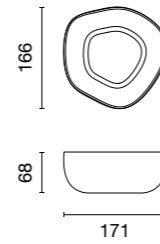

Pebble Medium

design by Nendo

art. 5061

MATERIALE / MATERIAL
Melamina / Melamine



Black

Orange

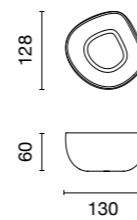

Pebble Small

design by Nendo

art. 5060

MATERIALE / MATERIAL
Melamina / Melamine



White

Black

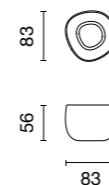

Djambè Tapas Large

design by Look Out

art. 6020

MATERIALE / MATERIAL
Policrystal®



Clear

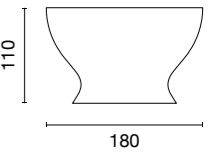

Djambè Tapas Medium

design by Look Out

art. 6021

MATERIALE / MATERIAL
Policrystal®



Clear

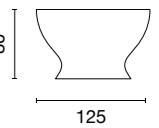

Fiesta Stopper

design by Italesse

art. 1043

MATERIALE / MATERIAL
Acrilico, silicone e acciaio
inox / Acrylic, silicone and
stainless steel



Clear

White

Black

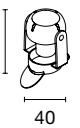

Fiesta Stopper Plus

design by Italesse

art. 1044

MATERIALE / MATERIAL
Acrilico, silicone e acciaio
inox / Acrylic, silicone and
stainless steel



Clear

White

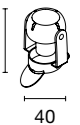

Ocean Stopper

design by Minedivine

art. 1040

MATERIALE / MATERIAL
**Acrilico, silicone e acciaio
 inox / Acrylic, silicone and
 stainless steel**

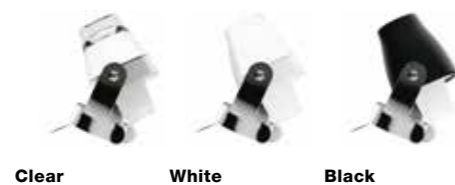

Clear

White

Black

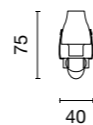

Lollipop

design by Marco Zanatta

art. 1042

MATERIALE / MATERIAL
Silicone / Silicone



White

Black

Red

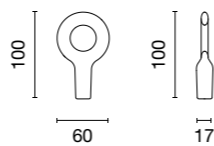

Designers & Opinion Leaders



Todd Bracher

- 👤 Designer - Industrial and Product Design.
- 📍 New York, USA.
- 🔪 Italesse Projects: Vas Carafe.



Claesson Koivisto Rune

- 👤 Design Studio - Industrial Design, Architecture & Interior Design, Product Design.
- 📍 Stockholm, Sweden.
- 🔪 Italesse Projects: Richard Juhlin Optimum Champagne Glass, Tonic Glassware and Ice-Buckets.



Luca Trazzi

- 👤 Designer - Industrial and Product Design, Architecture.
- 📍 Milano, Italy.
- 🔪 Italesse Projects: Bolle Glassware, Ice-Buckets and Accessories, Wormwood Glassware, Plaza Ice-Buckets.



Federico Venier

- 👤 Designer - Industrial Design, Architecture & Interior Design, Product Design.
- 📍 London, UK.
- 🔪 Italesse Projects: Vinocchio and Alavin Decanters, Easy Ice-Buckets, Pagoda and Grand Pagoda Ice-Buckets.



Marco Zanatta

- 👤 Designer - Product Design.
- 📍 Varese, Italy.
- 🔪 Italesse Projects: Lollipop Stopper.



Giancarlo Mancino

- 👤 Opinion Leader - Bartender / Bar Consultant.
- 📍 Hong Kong.
- 🔪 Italesse Projects: Wormwood Glassware.



Minedivine

- 👤 Design Studio - Industrial, Product and Graphic Design.
- 📍 Treviso, Italy.
- 🔪 Italesse Projects: Bongo Ice-Buckets, Organica Carafe, Ocean Stopper, Sfera Glassware.



Luca Nichetto

- 👤 Designer - Industrial Design, Architecture, Product Design.
- 📍 Stockholm, Sweden.
- 🔪 Italesse Projects: Stripe Tray, Venti4 and Fresnel Collections.



Nendo

- 👤 Designer - Industrial Design, Architecture, Product Design.
- 📍 Tokyo, Japan.
- 🔪 Italesse Projects: Pebble Bowls.



Carlos Tíscar

- 👤 Designer - Industrial and Product Design.
- 📍 Valencia, Spain.
- 🔪 Italesse Projects: Solomon Ice-Buckets.



Richard Juhlin

- 👤 Opinion Leader - Champagne Expert.
- 📍 Stockholm, Sweden.
- 🔪 Italesse Projects: Richard Juhlin Optimum Champagne Glass.



Maitres Cuisiniers de France

- 👤 Opinion Leader - Largest Worldwide French Chef association.
- 📍 Paris, France.
- 🔪 Italesse Projects: Etoilé Glassware.



Luca Bini

- 👤 Opinion Leader - AIS Sommelier and Hospitality Professional.
- 📍 Trento, Italy.
- 🔪 Italesse Projects: Etoilé Sparkle Flute.



Paolo Lauria

- 👤 Marketing and Project Manager Italesse - AIS Sommelier
- 📍 Firenze, Italy
- 🔪 Italesse Projects: Senses, Wine 360°

Photography:
Thomas Zanon Larcher
Roberto Maffioli / Italesse
Escapista
Azimut Photo / Massimo Gardone
Roberto Pastrovicchio

Graphic Design:
Fabrizio Gabrielli

Print:
Grafica Goriziana

Italesse s.r.l.

**Via Dei Templari 6
loc. Noghere - 34015 Muggia
Trieste - Italy**

**T +39 040 9235555
F +39 040 9235251**

**italesse@italesse.it
www.italesse.com**

© 2020