



# OTIS™

## SMART GUN CARE

#AMERICASGUNCARE

## LAW ENFORCEMENT PRODUCT CATALOG



*Otis is proud to support Law Enforcement efforts across the US. Each year we donate a portion of sales from our law enforcement product line to a Law Enforcement charity of our choice.*



### PROFESSIONAL PISTOL KIT FOR GLOCKS

#FG-901-945

**Cleans 9mm, .40 cal & .45 cal Glock Pistols**

- 10" x 4" x 2" Soft Pack
- 9mm, .40 cal & .45 cal Ripcords®
- 8" Memory-Flex® Cable with affixed tip
- 9mm, .40 cal & .45 cal Bronze Bore Brushes
- 9mm, .40 cal & .45 cal Nylon Bore Brushes
- Slotted Tip
- Obstruction Remover
- Pistol Loop Rod
- 8-in-1 Pistol T-Tool
- Magazine Plate Disassembly Tool
- Double-ended AP Brush
- 0.5 oz Shooter's Choice FP-10 Lubricant Elite® CLP
- 2 1/2" Square & 3" Panoply Cleaning Patches (10 each)
- BONUS** Flag Glock Back Plate
- Instruction Manual

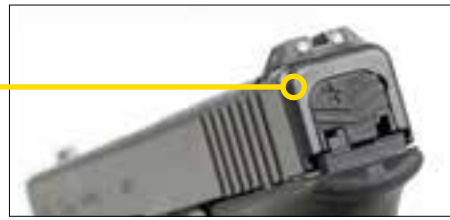

### ARMORER'S PISTOL TOOL

#FG-248-645C

The Armorer's Pistol Tool offers four tools in one to service and maintain your semi-automatic pistols such as Glock, Sig Sauer, Smith & Wesson, Ruger, Taurus, FNH, and H&K. Simply unscrew the nylon end brush to reveal a storage area for additional tools. Disassemble your pistol with ease using the 3/32" pin punch to knock out pins. Install, adjust or remove after-market front sights with the 3/16 nut driver. Remove the trigger connector with the small flat head screwdriver. Brush off any debris with the nylon end brush. The main body of the tool is textured for improved grip while working. Clip the tool in your pocket or in a compartment of your range bag.

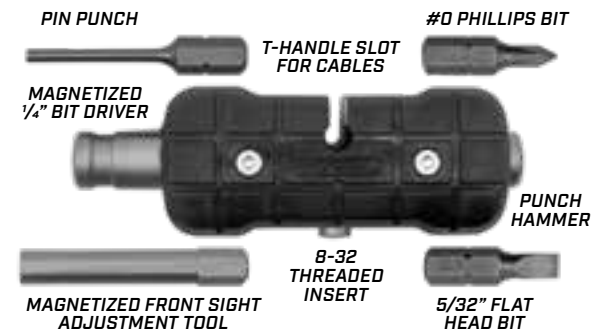

### 8-IN-1 PISTOL T-TOOL

#FG-THT-P1

This small, yet mighty tool is an essential item for any striker-action pistol owner. Handles a variety of maintenance needs for your pistol all in one tool that easily fits in your pocket, range bag or pistol case. The base handle has four distinct purposes - 1/4" bit driver, 8-32 threaded insert to accommodate additional components, Memory-Flex® cable slot for use as a T-handle and punch hammer for resetting pins. The tool also includes four bits that seat in the magnetized bit driver. The pin punch has additional length to fully push takedown pins through the frame. Keep from losing the nut on the front sight with the magnetized front sight adjustment tool. The tool also comes with one 5/32" flat head and one #0 Phillips bit.

### MAGAZINE PLATE DISASSEMBLY TOOL FOR GLOCKS

#FG-GMDT

Safely and easily remove the magazine plate on Glock magazines for proper cleaning, maintenance and inspection with the use of the Otis Magazine Plate Disassembly Tool. This tool removes the base plate in order to change out or replace springs. Works with standard Glock magazines and won't damage the plate or magazine body. Not for use with Glock 30 round magazines or extended type base plates.



## AR ELITE RANGE BOX

#FG-4016-AR

**Cleans 5.56mm AR-15 style rifles**

For the AR owner who has it all, the AR Elite Range Box is the gun cleaning kit that has it all – and more for AR-15 style rifles. This universal gun cleaning kit provides proper Breech-to-Muzzle® cleaning for AR-15 style rifles plus all the tools you need to pick, scrape and clean caked on carbon and fouling. Properly make sight adjustments and keep your optics clean. Breakdown your ARs safely without fear of marring with the included bench block. This comprehensive range box includes 5.56mm gear: AR Cleaning Kit, B.D.N.E.® Tool, Star Chamber Cleaning Tool and replacement pads, extra bore brushes & mops, Ripcord®, All Purpose brush pack, gun cloth, gun towel pack, sight adjustment tool, lens cleaning kit, extra patches and Shooter's-Choice FP-10 Lubricant Elite® CLP. Made in the USA, it includes over 40 components plus 100 patches all contained in a portable range box that doubles as a gun vise for stability while cleaning.



OTIS TECHNOLOGY | SMART GUN CARE



### BREECH-TO-MUZZLE® CLEANING

- 30" Memory-Flex® Cable
- Bronze Bore Brushes [2] & Mops [2]
- Obstruction Remover
- Slotted Tip
- Pull Handle
- 2" Cotton Cleaning Patches [110]
- 0.5 oz FP-10 Lubricant Elite® CLP
- 4 oz FP-10 Lubricant Elite® CLP

### RIPCORD® PULL-THROUGH BORE CLEANER

### SPECIALIZED TOOLS

- B.D.N.E.® Tool
- Star Chamber Tool & Felt Pads [50]
- Chamber Brush

### GENERAL MAINTENANCE

- Pro+ Bench Block
- Microfiber Gun Towel [3]
- Microfiber Cloth
- Nylon, Blue Nylon & Bronze Double End AP Brushes
- Short AP Brush & Rod Handle
- Scraper
- Chamber Flag
- Locking Lug Scraper
- Straight & Bent Pick
- Pin Punch
- End Brush

### OPTICS CARE

- 0.5 oz Lens Cleaning Solution
- Lens Brush
- Lens Cloth
- Premium Lens Tissue
- Cotton Swabs [6]
- M4 SAT [Sight Adjustment Tool]

## B.O.N.E.® TOOL

**Cleans Bolt / Bolt Carrier / Firing Pin of ARs**

The B.O.N.E.® Tool was designed specifically to clean carbon and fouling from the bolt carrier assembly area of AR style rifles. This quick-clean tool scrapes fouling from the bolt, bolt carrier and firing pin. Also includes an 8-32 threaded hole to act as T-handle.

Available for 5.56mm or 7.62mm AR style rifles.

**Note:** While this tool fits many bolts flawlessly, it may fit some bolts better than others due to variance in bolts by different manufacturers.

5.56mm B.O.N.E.® Tool [NSN: 1005-01-647-0562] #FG-246

7.62mm B.O.N.E.® Tool #FG-276

Actual size shown

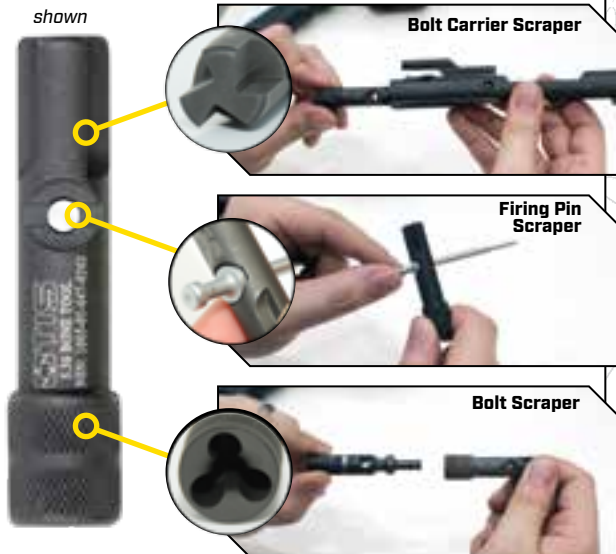

## STAR CHAMBER SCRAPER TOOL

**Cleans Star Chamber Area of AR style rifles**

This tool quickly and effectively cleans the star chamber in just a few twists. It features a parkerized steel scraper to remove fouling build-up and felt cleaning pads to pick up the fouling loosened by the scraper. The coated brass nose piece centers the tool in the chamber for proper cleaning, while ensuring it won't scratch or damage the firearm. With 8-32 threads, a chamber brush or other scraper components can be attached to this tool for added cleaning.

5.56mm AR-15 platforms

7.62mm AR-10 platforms

Star Chamber Cleaning Tool	#FG-2715	Star Chamber Cleaning Tool	#FG-2717
Star Chamber Pads (12 ct.)	#FG-2715-PD B	Star Chamber Pads (12 ct.)	#FG-2717-PD B
Star Chamber Pads (200 ct.)	#FG-2715PD-200	Star Chamber Pads (100 ct.)	#FG-2717PD-100



Unscrew nose piece to assemble scraper or felt cleaning pad



Insert scraper into star chamber and twist to scrape

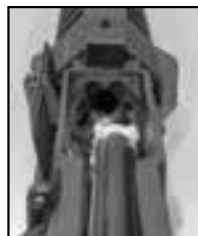

Replace with a cleaning pad and slide into position



Twist to clean. Repeat as many times as desired until clean



## MULTI-PURPOSE SCRAPER & BRUSH SET

#FG-386-3

**Cleans Firing Pins / Bolt / Chamber / Slide & More**

Our scrapers & brushes work hard so you don't have to. This 3 piece combo set is comprised of 5 scrapers and two all purpose brushes. These detailed scrapers cover a magnitude of cleaning - firing pins, bolts, chamber, slides, trigger group and more - with ease. Scrub hard to reach areas with the stiff nylon bristles or scrape fouling build up with the various scrapers. **Includes 5 scrapers to remove caked on carbon and fouling: angled scraper, flat scraper, pick, bolt scraper, firing pin scraper. 2 all purpose brushes are composed of a stiff blue nylon to scrub carbon and fouling accumulated from hard to reach areas.**

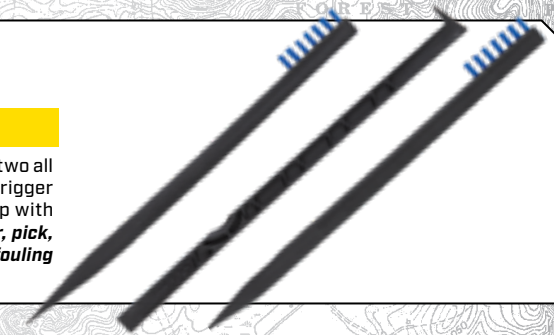

## M4 SAT (SIGHT ADJUSTMENT TOOL)

#FG-252 BX

**5.56mm AR Rifles**

Adjusting the sights on an M4 can be done using your fingernail or a round of ammo but get it done much quicker, easier and safer with the M4 SAT sight adjustment tool. This easy to use tool simply pushes down onto the front sight post. Rotate the click wheel on the tool clockwise to lower the post and counterclockwise to raise the post. You can hear and feel the tool click. Comes in a 2 pack.



## MSR CLEANING PACK

#FG-MSR-CP

**5.56mm AR Rifles**

All your favorite Otis cleaning gear for the 5.56mm AR style rifle is now included in one package. Clean the bolt carrier group, star chamber area, gas tube vent and bore with these tools. **Includes: Ripcord® (1), B.O.N.E.® Tool (1), Star Chamber Scraper Tool (1), Star Chamber Scraper, Felt Pads (6), AR Vent Hole Scraper (1), Chamber Brush (1), All Purpose Receiver Brush (1).**



## AR MAINTENANCE TOOL SET

#FG-932

**5.56mm AR Rifles**

The AR Maintenance Tool Set contains the tools to clean some of the most critical and hard to reach areas of your firearm. These tools will not scratch the firearm and allow for proper cleaning of areas such as the locking lugs, the slides, bolt face, rails, and any other hard to reach places. These components can be ordered as separate add-ons to all kits and will fit in existing Otis cleaning kits. **Includes: Scraper (1), Locking Lug Scraper (1), Straight Pick (1), Nylon End Brush (1), Compact Receiver Brush (1), Rod Handles (1 male, 1 female).**





## LAWMAN SERIES

Available in Single and Dual Caliber Configurations

Keep your rifle clean, clear, and ready to go with The Lawman Series weapons cleaning system, containing everything you need for a quick, one-pass clean to a full breakdown. Clean your firearm with three different cleaning methods, including the Ripcord® for a quick, one-pass clean, solid rod and everything you need for a Breech-to-Muzzle® clean with our Memory-Flex® cables, 100% cotton patches and brass components. Also included is a blue nylon all purpose brush and Shooter's Choice FP-10 Lubricant Elite® CLP (Components vary based on sku)

9mm Pistol	#LFG-901-9MM	1. Ripcord® and Memory-Flex® Cable
.40 cal Pistol	#LFG-901-40	2. Caliber Specific Bronze Bore Brush*
.45 cal Pistol	#LFG-901-45	3. Double ended AP Brush
5.56mm / .40 cal	#LFG-901-5540	4. Brass Components
5.56mm / .45 cal <i>[shown]</i>	#LFG-901-5545	5. Solid Rod**
5.56mm	#LFG-901-556	6. Chamber Brush***
5.56mm / 9mm	#LFG-901-556-9	7. Shooter's Choice FP-10 Lubricant Elite® CLP
5.56mm / 7.62mm	#LFG-901-5576	8. T-Tool with 4 bits
7.62mm	#LFG-901-762	9. Cleaning Patches
7.62mm / 9mm	#LFG-901-762-9	<i>*PISTOL ONLY KITS ALSO HAVE AN ADDITIONAL NYLON BORE BRUSH</i>
7.62mm / .40 cal	#LFG-901-7640	<i>**PISTOL ONLY KITS HAVE 1 ROD SECTION</i>
7.62mm / .45 cal	#LFG-901-7645	<i>***RIFLE OR RIFLE/PISTOL KITS ONLY</i>

## THIN BLUE LINE SERIES

Ripcord® Kits for One and Done Pull-Through Bore Cleaning

The Thin Blue Line kit features an Otis Ripcord®, caliber specific brush, slotted tip and patches in a convenient carry case. Also featured is 0.5 ounces of Shooter's Choice FP-10 Lubricant Elite® CLP. The special edition Thin Blue Line Ripcord® Kits are available in the following calibers:

5.56mm Rifle	#LFG-913-556TBL	9mm Pistol	#LFG-913-9MMTBL	5.56mm / 9mm*	#LFG-913-556-9TBL
7.62mm Rifle	#LFG-913-762TBL	.40 cal Pistol	#LFG-913-40TBL	5.56mm / .40 cal*	#LFG-913-5540TBL
12 ga Shotgun	#LFG-913-12TBL	.45 cal Pistol	#LFG-913-45TBL	5.56mm / .45 cal*	#LFG-913-5545TBL

1. Ripcord® 2. Cleaning Patches 3. Caliber Specific Bronze Bore Brush 4. Brass Components 5. Shooter's Choice FP-10 Lubricant Elite® CLP



9mm Pistol shown



## POLICE / TACTICAL HANDGUN KIT

Cleaning Kits for Rifles, Pistols or Shotguns

Available in three different configurations, these weapons maintenance kits properly clean 9mm, .40 cal, or .45 cal. weapon platforms, featuring Ripcord® and solid rod Breech-to-Muzzle® cleaning equipment. Includes everything needed for quick field cleaning or full breakdown back in garrison.

15" x 13" x 9" Soft Pack	Nylon & Bronze AP Brushes
Instruction Manual	2.5" square Cleaning Patches (200)
Ripcord®	4 oz Shooter's Choice MC-7
Solid Brass Cleaning Rod with Swivel handle (8-32 thread)	0.5 oz Shooter's Choice FP-10 Lubricant Elite® CLP
Bronze Bore Brush & Map	Slotted Tip
Pierce Point Jag	Cotton Cloth for exterior wipe down
Lead Remover Hand Wipes & Nitrile Gloves	
<b>AVAILABLE IN 3 CONFIGURATIONS</b>	
9mm Pistol	#LFG-101-9MM
.40 cal Pistol	#LFG-101-40
.45 cal Pistol	#LFG-101-45



## ULTIMATE LE CLEANING KIT

#LFG-1001

Cleans 5.56mm & 7.62mm Rifles, 9mm, .40 cal & .45 cal Pistols and 12 GA Shotguns

The ultimate in weapons maintenance, the Ultimate Cleaning Kit properly cleans 5.56mm and 7.62mm rifles, 9mm, .40cal and .45cal pistols and 12ga shotguns featuring Ripcord®, solid rods, Breech-to-Muzzle® cleaning equipment and dedicated AR cleaning tools. Also includes precision cleaning tools and optics cleaning gear giving you everything needed for a team to conduct quick field cleaning or full breakdowns.

15" x 13" x 9" Soft Pack	Instruction Manual
5.56mm, 7.62mm, 9mm, .40 cal, .45 cal & 12 GA Ripcords®	5.56mm, 7.62mm, 9mm, .40 cal, .45 cal & 12 GA Bronze Bore Brushes
Solid Rod Set (8-32 thread)	5.56mm Chamber Brush
8" & 30" Memory-Flex® Cables	Small & Large Slotted Tips
0.5 oz Shooter's Choice FP-10 Lubricant Elite® CLP (2)	
Small & Large Obstruction Removers	2" Cotton & 3" Panoply Cleaning Patches
Lens Brush	Scraper
Blue Nylon & Bronze AP Brushes	
Straight & Bent Pick	
Lens Cloth & Pipe Cleaners	
Pin Punch	
Locking Lug Scraper	



### ESSENTIAL SERIES

#### Cleaning Kits for Rifles, Pistols or Shotguns

The Essential Cleaning Kits by Otis offer the essential firearm maintenance gear to properly clean from Breech-to-Muzzle®. Each cleaning kit is designed to clean one caliber or gauge. Made in the USA and at a price that won't break the bank, you can pick one up for every firearm that you own.

- Memory-Flex® cable, slotted tip, patches & bore mop for effective and correct Breech-to-Muzzle® cleaning
- Caliber specific bronze bore brush removes deposits and other fouling
- Pull handle quickly attaches to cable for added comfort
- Short AP brush for cleaning hard to reach areas
- Chamber brush, rod, curved & straight locking lug pick for proper cleaning of chamber and locking lugs *(only available in 5.56mm version)*

9mm Pistol	#LFG-701-9MM
.40 cal Pistol	#LFG-701-40
.45 cal Pistol	#LFG-701-45
5.56mm Rifle (Shown Above)	#LFG-701-556
7.62mm Rifle	#LFG-701-762
12 ga Shotgun	#LFG-701-12



### RIFLE / PISTOL

#LFG-904-57945

#### Cleans 5.56mm & 7.62mm Rifles, 9mm, .40 cal & .45 cal Pistols

Officers who carry more than one weapon shouldn't have to carry more than one weapons maintenance kit. You'll find all the basics in the Rifle/Pistol Cleaning Kit. Specifically designed to clean and maintain all 5.56mm and 7.62mm rifles and 9mm, .40 cal and .45 cal pistols. Includes Breech-to-Muzzle® cleaning gear with a Memory-Flex® Cable or solid rods, plus extra cleaning tools. Made in the USA and contained in a lightweight, compact soft pack case.

10" x 4" x 2" Soft Pack	5.56mm Chamber Brush
Instruction Manual	Slotted Tips
Solid Rod Set (8-32 thread)	Blue Nylon AP Brushes
30" Memory-Flex® Cable with affixed tip	Obstruction Removers
5.56mm, 7.62mm, 9mm, .40 cal & .45 cal Bronze Bore Brushes	0.5 oz Shooter's Choice FP-10 Lubricant Elite® CLP
2" Cotton & 3" Panoply cleaning patches	



### LE RANGE BOXES

Available in 5.56mm, 7.62mm, 9mm, .40 cal & .45 cal

Designed for training ops at the range but great for a group of friends or shooting club too, the Training Range Box includes enough gear for proper Breech-to-Muzzle® cleaning of up to 25 firearms at one time. Includes Memory-Flex® Cables, bronze bore brushes, brass components, blue nylon AP brushes, and solvent, all neatly packed in a hard plastic range box and available in several configurations.

#### TRAINING RANGE BOX (IDEAL FOR 25 PEOPLE)

5.56mm	#FG-4016-556-T
7.62mm	#FG-4016-762-T
9mm	#FG-4016-9MM-T
.40 cal	#FG-4016-40-T
.45 cal	#FG-4016-45-T

#### TEAM RANGE BOX (IDEAL FOR 10 PEOPLE)

5.56mm & 9mm (Shown above)	#FG-4016-9MM
5.56mm & .40 cal	#FG-4016-41
5.56mm & .45 cal	#FG-4016-45
5.56mm, 9mm & 12 ga	#FG-4016-9MM-410
5.56mm, .40 cal & 12 ga	#FG-4016-40-410
5.56mm, .45 cal & 12 ga	#FG-4016-45-410
Universal Range Box 5.56mm, 7.62mm, 9mm & 12 ga	#FG-4016-U



### ELITE RANGE BOX

#FG-4016-1000

#### Clean .17 cal to 12 GA

For the professional gun owner who has it all, the Elite Range Box is the gun cleaning kit that has it all – and more. This universal gun cleaning kit provides proper Breech-to-Muzzle® cleaning for all rifles, pistols, shotguns and inline muzzleloaders. Includes 16 bore brushes plus everything needed for complete Breech-to-Muzzle® cleaning. This cleaning kit also features 4 Ripcords® - 5.56mm, 7.62mm, 9mm & 12 ga - for quick cleaning in the field, the B.O.N.E.® Tool which makes cleaning the bolt carrier assembly of AR style rifles a breeze, and Shooter's Choice FP-10 Lubricant Elite® CLP (4oz and 0.5 oz bottles) and 0.34 oz All Weather Grease. Made in the USA, it includes over 60 components all contained in a portable range box that doubles as a gun vise for stability while cleaning.





## DELUXE LAW ENFORCEMENT

#FG-85211

**Cleans 5.56mm & 7.62mm Rifles, 9mm, .40 & .45 cal Pistols/Subguns and 12 GA Shotguns**

4" x 4" x 2½" Soft Pack

8" (affixed slotted tip) & 30" Memory-Flex® Cables

5.56mm, 7.62mm, 9mm, .40 cal, .45 cal & 12 GA Bronze Bore Brushes

Small, Large & Shotgun Slotted Tips

Small, Large & Pistol Obstruction Removers

0.5 oz Shooter's Choice FP-10 Lubricant Elite® CLP

Short AP Brush & Rod Handles

Pull Handle Nylon End Brush

Scraper Pin Punch

Straight & Bent Pick

Small & Large Patch Savers®

2" & 3" Cleaning Patches (10 each)

Chamber Flag

Instruction Manual



## LE RIFLE / PISTOL

#FG-223-645

**Cleans 5.56mm rifles and 9mm through .45 cal Pistols & Subguns**

4" x 4" x 2½" Soft Pack

8" (affixed slotted tip) & 30" Memory-Flex® Cables

5.56mm, 9mm, .40 cal & .45 cal Bronze Bore Brushes

Small & Large Slotted Tips

Small & Large Obstruction Removers

0.5 oz Shooter's Choice FP-10 Lubricant Elite® CLP

Scraper End Brush

Straight & Bent Pick

Short AP Brush & Rod Handles

Pull Handle

2" & 3" Cleaning Patches (10 each)

Chamber Flag

Instruction Manual



## PROFESSIONAL PISTOL CLEANING KIT

3 SKUS - SEE BELOW

**Clean 9mm, .40 or .45 cal**

4" x 4" x 2½" Soft Pack

8" (affixed slotted tip) Memory-Flex® Cable

Bronze Bore Brush  
9mm or .40 cal or .45 cal

Bore Mop  
9mm or .40 cal or .45 cal

Obstruction Remover

0.5 oz Shooter's Choice FP-10 Lubricant Elite® CLP

Scraper End Brush

Straight & Bent Pick

Short AP Brush & Rod Handle

Pin Punch Pull Handle

3" Panoply Cleaning Patches (10)

Chamber Flag

Instruction Manual

### 9MM

#FG-645-9\*  
\*kit displayed

### .40 CAL

#FG-645-41

### .45 CAL

#FG-645-45



## LESS LETHAL CLEANING KITS

#LFG-374012

**Cleans 37mm/40mm Grenade Launchers**

10" x 4" x 2" Soft Pack with MOLLE Strap

30" Memory-Flex® Cable with end cap

37/40mm Brush

12 ga Bronze Bore Brush

Less Lethal T-Handle Tool

0.5 oz Shooter's Choice FP-10 Lubricant Elite® CLP

4" Specialized Cleaning Patches (10)

Instruction Manual

#LFG-3740

**Cleans 37mm/40mm Grenade Launchers**

20" Memory-Flex® Cable with end cap

37/40mm Brush

T-Handle

4" Specialized Cleaning Patches (10)

Instruction Manual





### REALITY BASED TRAINING CLEANING KIT

#LFG-100-9MM | #LFG-100-556 (SHOWN ABOVE)

**Cleans 9mm Pistol or 5.56mm Rifles**

For firearms that are converted to use paint marker training ammunition, Otis offers the Reality Based Cleaning Kit. Training in as real-life simulated scenarios as possible is incredibly important and so is maintaining those training guns. Paint marker training ammunition leaves plastic build up that can cause cycling malfunctions if not cleaned regularly. Includes Breech-to-Muzzle® cleaning tools for properly cleaning the bore such as Ripcord®, slotted tip, bore brush and 100% cotton 2" patches. Also includes locking lug pick and single tip cotton swabs for removing any paint or projectile fragments from the chamber, a stiff blue nylon AP brush for removing plastic or paint fouling from the bolt face and lugs. Featuring Shooter's Choice Quick Scrub and FP-10® Lubricant Elite® CLP for proper bore cleaning. #LFG-100-556 includes a chamber brush and solid rod set for proper cleaning of star chamber area.



### LE UNIVERSAL CLEANING KIT

#LFG-998

**Cleans 5.56mm - 12 GA**

The Otis LE Universal Cleaning Kit delivers top notch performance and durability to our LED's by ensuring a proper Breech-to-Muzzle® cleaning experience standard to the Otis® brand. This universal gun cleaning kit comes complete with 6 firearm specific bronze bore brushes as well as a 5.56mm chamber brush for cleaning AR style rifles. Designed to clean .22 cal, 5.56mm, .30 cal rifles, 9mm, and .45 cal pistols, and 12 ga shotguns with both solid rod and Memory-Flex® cable cleaning methods, this kit also includes high quality brass components with 8-32 threads. The stiff nylon AP brush is ideal for fine cleaning and the 100% cotton patches and microfiber gun cloth tackle carbon and fouling with the help of Shooter's Choice FP-10 Lubricant Elite® CLP. Packed in a hard case with durable clasps.



### ANATOMY OF A RIPCORD®

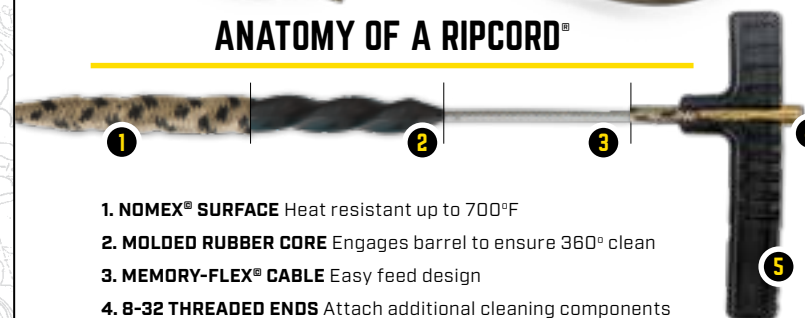

- 1. NOMEX® SURFACE** Heat resistant up to 700°F
- 2. MOLDED RUBBER CORE** Engages barrel to ensure 360° clean
- 3. MEMORY-FLEX® CABLE** Easy feed design
- 4. 8-32 THREADED ENDS** Attach additional cleaning components
- 5. T-HANDLE** For a better grip

### RIPCORD®

**Pull-Through Bore Cleaner**

Ripcord® delivers the best one-pass cleaning you can get. Run it through your gun from Breech-to-Muzzle®, with no gravity feed necessary. The rigid, helix-shaped rubber core keeps the cleaning surface pressed against the bore, engaging the rifling for an aggressive clean. The braided Nomex® surface can take up to 700° heat, so you can clean it at the range or in the field while the barrel's still hot. It's fast, effective and ultra-portable.

5.56mm Rifle	#LFG-RC-325	.40 cal Pistol	#LFG-RC-341
7.62mm Rifle	#LFG-RC-330	.45 cal Pistol	#LFG-RC-345
9mm Pistol	#LFG-RC-338	12 GA Shotgun	#LFG-RC-512
5.56mm/9mm/12 GA 3 Pack		#FG-RC-3G1	





## OSCR - OTIS SUPPRESSOR CLEANER & RECLAIMER

Suppressors get dirty in a hurry with carbon, copper and lead fouling building up in the baffles, decreasing the efficacy of sound reduction and increasing the operator's exposure to toxic fumes from off-gassing. The OSCR (Otis Suppressor Cleaner & Reclaimer) is an automated suppressor cleaner system that removes 90-95% of fouling build up and cleans even the most complex baffle structures. Keep suppressors in peak condition and in service longer by including the OSCR as part of a regular preventative maintenance schedule.

- Available in two models (6 unit and single unit)
- Accommodates suppressors up to 2" in diameter and up to 15" in length
- Keep suppressors in service longer or reclaim previously classified "unserviceable" suppressors
- Customize temperature and run times
- Easily cleans even the most complex of baffles
- Removes 90-95% of fouling build up
- Easy to use interface with digital touchscreen controls
- Clean up to six suppressors in as little as 2 hours (OSCR-6 only)
- Safe for use on suppressors constructed of anodized aluminum, stainless steel, Inconel and titanium and is also safe on all Mil. Spec finishes
- Use only with OSCR Suppressor Cleaning Fluid Concentrate
- Made in the USA



**OSCR-1**  
#FG-OSCR-1  
One Unit System  
20.75" W x 16" L x 22" H  
100 lbs



OSCRs are proudly engineered and assembled in America

**OSCR-6**  
#FG-OSCR-6  
Six Unit System  
25" W x 24" L x 48" H  
300 lbs



One cycle in OSCR-6 requires 1 gallon of concentrate.

## OSCR SUPPRESSOR CLEANING FLUID CONCENTRATE

#FG-928-SCFC

- Concentrated formula (recommended 10:1 water to concentrate)
- Designed for use with OSCR automated suppressor cleaner system
- Effectively removes 90-95% of fouling build up
- Safe for use on anodized aluminum, stainless steel, Inconel & titanium suppressors
- Safe on all mil-spec finishes



## MISSION CRITICAL HIGH PERFORMANCE GREASE & LUBRICANT

with Microfiber Cloth

#FG-MCLGC

A unique mix of aerospace-industry lubricants that was formulated specifically for firearms, MC-10 delivers unrelenting protection from -65° all the way up to 650°F. It doesn't look or feel like other formulas—and it doesn't break down like other formulas when things get heated. When the mission is critical, MC-10 delivers without compromise.

This combo package includes a 1 fl. oz. spray bottle of MC-10 high performance synthetic lubricant as well as a MC-10 high performance synthetic grease contained in a 3mL precision applicator pen brush. These formulas deliver the ultimate in friction protection and won't freeze, burn or carbonize – even in extreme temperatures. The grease pen delivers ultimate control to apply in precise areas such as the actions, triggers & slides.

## MC-10 FULL AUTO GREASE PEN

#FG-9013-MC10

The MC-10 Full Auto Grease Precision Applicator Brush delivers the ultimate friction protection for actions, triggers and slides. MC-10 is a High Performance Synthetic Firearm Grease that will not freeze, burn, or carbonize in extreme temperatures. Simply click the yellow precision push button for ultimate control and apply to high friction areas for the ultimate protection. Includes: 3 ml of MC-10 High Performance Grease in a precision applicator pen brush.

## LEAD REMOVER HAND WIPES

Removes Lead, Nickel, Cadmium, Arsenic, Chromium and other metals from skin quickly and easily without soap or water. Can be tossed in your range bag or kept on your gun cleaning bench to remove harmful lead after shooting and reloading. Available in 40 count canister or 50 individually packaged 6" x 7" packets in a PDQ Dispenser.

40 Count Canister	#FG-40C-LRW
PDQ Dispenser	#FG-LRW-50



## DRY LUBE

Quickly and effectively lubricate your firearm in the most unforgiving environments. Dries to the touch in less than 20 seconds and seals out moisture with a thin film of lubricant.

2 oz. Aerosol	#RW-902-A-55 BU
4 oz. Aerosol	#IP-904-A-55



## FOAMING BORE CLEANER

#RW-903-A-FC

Let expanding foam and time do the hard work in cleaning your firearm. Simply spray in the breech end and the foam will expand to fill the bore and ensure complete product coverage. Let sit until foam breaks down and then remove using an Otis Breech-to-Muzzle® cleaning kit or Ripcord®.



## O85® CLP

O85® CLP is our most time-tested formula, with over 30 years of proven performance in cleaning, lubricating and protecting firearms. But don't let old age fool you. O85® CLP uses advanced engineering to penetrate tight spaces and create a thin film that stops rust and corrosion for long-lasting protection. Cleans, lubricates and protects in one advanced formula while removing carbon, powder residue and fouling from metal surfaces. Penetrates into tight areas to reduce surface friction and leaves a thin film that seals out moisture to prevent rust and corrosion.

4 oz. Tin	#IP-904-O85
Dual Pack Wipes	#IP-2TW-O85
40 Count Wipes Canister	#IP-40C-O85
75 Count Wipes Canister	#IP-75C-O85



## REPLACEMENT BRUSHES & MOPS

RIFLE/PISTOL (2")	BRONZE & MOP	BRONZE & NYLON
5.56mm	#FG-322-MB	#FG-322-NB
7.62mm	#FG-330-MB	#FG-330-NB
9mm	#FG-338-MB	#FG-338-NB
.40 cal	#FG-341-MB	#FG-341-NB
.45 cal	#FG-345-MB	#FG-345-NB

SHOTGUN (2")	BRONZE & MOP	BRONZE & NYLON
12 Gauge	#FG-512-MB	#FG-512-NB

## REPLACEMENT BRONZE & NYLON BRUSH 10 PACKS

CALIBER	BRONZE	NYLON
5.56mm	#FG-325-BP	#FG-325-BP-N
7.62mm	#FG-330-BP	#FG-330-BP-N
9mm	#FG-338-BP	#FG-338-BP-N
.40 cal	#FG-341-BP	#FG-341-BP-N
.45 cal	#FG-345-BP	#FG-345-BP-N



## CHAMBER BRUSHES

The tapered bronze bristles scrub the chamber, neck and shoulder. The steel bristles at the base scrub the star chamber of the locking lugs.

5.56mm Brush	#FG-367 HT
7.62mm Brush	#FG-368 HT

## CLEANING PATCHES

2" Cleaning Patches: .17 - .223 cal	3" Cleaning Patches: .223 cal - 12 GA	3" Panoply Cleaning Patches: .30 cal - 12 GA
2" Cleaning Patches (Qty. 100)		#FG-918-100
2" Cleaning Patches (Qty. 1,000)		#FG-918-1M
3" Cleaning Patches (Qty. 100)		#FG-919-100
3" Cleaning Patches (Qty. 1,000)		#FG-919-1M
3" Cleaning Patches (Qty. 10,000)		#FG-919-10M
3" Panoply Cleaning Patches Large Bore (Qty. 80)		#FG-970-75
4" Grenade Launcher Patches (Qty. 100)		#IP-920-100

## MICROFIBER GUN CLOTH 3 PACK

#RW-3501-3

The Otis Microfiber Gun Cloth is perfect for cleaning all surfaces. This 12" x 8" reusable cloth is ideal for use on firearms, tools and knives as well as optics.



## GUN TOWEL 3 PACK

#RW-3502-CG-3

Ideal for use on firearms, tools, knives, and optics, the Otis Gun Towel 3-pack is perfect for cleaning a variety of surfaces without leaving behind lint and debris. Toss in your range bag or keep at your work bench. Easily remove dirt, gunpowder, blood, oils and grease. Three highly absorbent 12"x27.5" reusable microfiber gun towels are included.

## PISTOL CLEANING MAT

#FG-3801

Perfect for pistol cleaning or small gunsmithing projects. Non-slip rubber backing prevents oils from penetrating through to your bench and is lightly padded to protect your firearm. Measures 11" x 17".



## SPORTSMAN'S CLEANING MAT

#AD-3800

The Sportsman's Cleaning mat boasts over 1001 uses. This neoprene mat is waterproof and measures 35.25" x 17.75". Ideal as a gun cleaning and reload mat and large enough for rifles, pistols and shotguns. It can be used as a seat in the woods or to kneel on while cleaning your game. This non-slip pad is also great for precision work, resting your firearms on while at the range or on the tailgate of your pickup truck, and much more.



## LENS CLEANING SUPPLIES

Everything necessary to preserve the quality and functionality of scopes, rangefinders, laser sighting devices, binoculars, cameras & eyewear.

Lens Cleaning Kit*	#FG-244
Lens Brush	#RW-3762
Lens Tissues	#RW-422
Lens Solution 0.5 oz.	#RW-427
Cotton Swabs (6 ct.)	#IP-240-B

\*Contains 1 of each item



## ALL PURPOSE (AP) BRUSHES

Available in Nylon, Blue Nylon, Bronze & Stainless Steel

Otis All Purpose Receiver Brushes have double ends to allow for large surface scrubbing with one end and precision cleaning with the smaller end. AP Brushes are great for reaching hard to clean areas of your firearms. Other uses include automobile detailing, boats, golf equipment, battery terminals, camping, grout, jewelry, wood working, RC hobbies, crafts, and more.



### Nylon & Blue Nylon

- Removes fresh carbon or powder residue but won't scratch your firearm finish
- For everyday use and can be used on virtually any surface including wood surfaces
- Nylon brush Meets Military Specification
- Blue Nylon brush features stiff bristles that allow for a more aggressive clean

### Bronze & Stainless Steel

- Scrub hard to reach places where carbon, powder, and copper residue build up
- Recommended for cleaning the area around the firing pin
- Perfect for slides, receivers and locking lugs
- Cleans stubborn residue on metal surfaces that require more aggressive scrubbing action
- Stainless steel for use on internal firearm parts only

## DESCRIPTION

## PART#

3 Pack - Nylon (1), Blue Nylon (1), Bronze (1)	#FG-316-3-NBBZ
3 Pack - Nylon (1), Bronze (1), Stainless Steel (1)	#FG-316-3
3 Pack - Nylon (2), Blue Nylon (1)	#FG-316-NB-3
9 Pack - Nylon (3), Bronze (3), Stainless Steel (3)	#FG-316-BP
9 Pack - Nylon (3), Blue Nylon (3), Bronze (3)	#IP-316-9-BBN
50 Pack - Bronze	#IP-316-BZ-50
50 Pack - Nylon	#IP-316-50
50 Pack - Blue Nylon	#IP-316-BLU-50
50 Pack - Stainless Steel	#IP-316-SS-50



### BIO-DEGRADABLE BORE CLEANER

**NEW RELEASE**

Looking for an effective bore cleaner that's environmentally friendly? Shooter's Choice new Bio Bore Cleaner does both. It effectively removes oil, grease and powder build-up and is non-hazardous. This product contains no petroleum type solvents and is biodegradable. Available in 0.5 oz, 4 oz and 1 gallon. Tough. Effective. Environmentally Friendly. Check, check and check.

0.5 oz Bottle	#SHF-BBC005
4 oz Bottle	#SHF-BBC4
1 Gallon	#SHF-BBC128

### MAXIMUM STRENGTH COPPER REMOVER

Specifically formulated to attack copper and gilded metals left by jacketed ammunition. Our copper remover also does a phenomenal job restoring accuracy and performance to old or neglected firearms.

8 oz Bottle	#SHF-CRS08
1 Gallon	#SHF-CRS128



### BRASS CASE CLEANER

1 Gallon | #SHF-BCC128

**NEW RELEASE**

This biodegradable, environmentally friendly formula is especially formulated to clean brass cartridges. Non-toxic, non-flammable and non-hazardous, Shooter's-Choice Cartridge Case Cleaner is easy to apply and will effectively break up and remove fouling and dissolves oil, grease & powder build up. Available in a 1 gallon jug concentrate and designed to work in conjunction with ultrasonic cleaning tanks.



### FOAMING BORE CLEANER

3 oz | #SHF-903-A-FC

**NEW RELEASE**

Let expanding foam and time do the hard work in cleaning your firearm. Simply spray in the breech end and the foam will expand to fill the bore and ensure complete product coverage. Let sit until foam breaks down and then remove using a cleaning kit of your choice.



### MC-7 EXTRA STRENGTH BORE CLEANER

12 oz Aerosol | #SHF-MC7XT

As a result of constant testing and the pursuit to deliver the most effective products, MC-7 Extra Strength was born. As an aerosol formula, it is more efficient at breaking down harmful residues left behind in the bore. This product is also effective for black powder.

### LEAD REMOVER

4 oz Tin | #SHF-LRS04

Our lead remover is a specialized formula to remove lead, carbon and powder from all your firearms without the use of harsh abrasives or mechanical devices.



### MC-7 BORE CLEANER

The MC-7 Bore Cleaner is the original and a staple for bore cleaning since the '80s. Highly effective in removing copper, lead, and carbon not to mention powder and wad fouling. This powerful cleaner can also be used on black powder guns.

4 oz Tin	#SHF-MC704
16 oz Glass Jar	#SHF-MC716
1 Gallon Tin	#SHF-MC7128



### SHOTGUN & CHOKE TUBE CLEANER

12 oz Aerosol | #SHF-SG012

Engineered to deliver superior results on shotgun barrels especially choke tubes and ports. This cleaner removes plastic, lead and powder fouling as well as carbon build-up on operating mechanisms.



### FP-10 LUBRICANT ELITE® CLP

FP-10 is an elite level lubricant that dramatically reduces friction and wear on moving metal parts. This formula will not build-up or change tolerances and operates from -49°F to +500°F and even helps prevent lead and copper from accumulating. This is a very versatile product with excellent cleaning and protecting qualities and can also be used on compound bows and fishing equipment.

0.5 oz Bottle	#SHF-FPL005
4 oz Tin	#SHF-FPL04
4 oz Aerosol	<b>NEW RELEASE</b> #SHF-904-A-FPL
1 Gallon	#SHF-FPL128
36 piece canister of 0.5 oz	#SHF-FPL036
FP-10 Precision Set	#SHF-FPLAP
75 count wipe canister	<b>NEW RELEASE</b> #SHF-75C-FP10



### QUICK SCRUB III

15 oz Aerosol | #SHF-DG315

When fast and convenient cleaning is important, there is nothing better than Quick Scrub III. This product is made to remove surface residue, powder and soft carbon without disassembly. For restoration of precision trigger pulls and trouble-free action, try this quick evaporating cleaner.



### POLYMER SAFE QUICK SCRUB

12 oz Aerosol | #SHF-PSQ12

This synthetic based cleaner is safe to use on almost any finish. From polymers to plastics this product is harmless and can be used on dipped or painted firearms as well as wood and synthetic stock models. With the same great performance as Quick Scrub III, this is the go-to product for worry free cleaning.



### ULTRASONIC CLEANING SOLUTION

This bio-degradable and non-toxic formula was specifically designed to be used in ultrasonic cleaning tanks. For dissolving oil, grease and powder build-up this non-corrosive product will do the job. This is a concentrated solution and can be diluted for use.

<b>NEW RELEASE</b> 1/2 Gallon	#SHF-UCS64
1 Gallon	#SHF-UCS128



### ALL WEATHER HIGH-TECH GREASE

10 cc Syringe | #SHF-G10CC

This synthetic grease effectively prevents metal damage in actions, bolts, frame rails and shotgun hinges/hardware. With the unique syringe applicator this odorless grease is easy to apply and will cling to metal surfaces for ultimate protection. Because of its formulation it will not gum-up, melt, stiffen or wash away and has an operating temperature range of -65°F to +350°F.



### UNIVERSAL GUN CARE PACK

#SHF-CLP01

The three essential steps in the Pro-Care System in one convenient kit. MC-7 to clean your bore, FP-10 to lubricate and Rust Prevent to protect. This universal kit has all the necessities to protect any firearm.



### RUST PREVENT

6 oz Aerosol | #SHF-RP006

Shooter's Choice Rust Prevent is a superior moisture displacing agent that provides an ultra thin protective barrier that prevents rust and corrosion. Not only is this a must for serious gun maintenance it will neutralize fingerprint acids on all metals.



**SHOOTER'S CHOICE BULLSEYE BOX®**  
 UNIVERSAL GUN CARE FOR RIFLES, PISTOLS & SHOTGUNS  
 #SHF-900-MC

The Shooter's Choice Bullseye Box® includes the necessary equipment for cleaning rifles, pistols and shotguns. Contained in a tackle box style case with pull out drawers for quick visibility of components. Includes solid rods with swivel handles for rifle/shotgun and pistol length and includes the brushes, mops and jags for .22/.223 cal, .243 cal, .270 cal, .30 cal, 9mm, .40 cal, .45 cal, 20 GA & 12 GA. Also includes 1" and 2.5" square patches (100 each). Properly clean, lubricate and protect your firearms with the included MC-7 cleaner (4 oz), FP-10 Lubricant Elite® CLP (0.5oz & 4oz), All Weather Firearm Grease (10cc) and Rust Prevent (6oz). Additional cleaning gear includes 3 all-purpose brushes, great for cleaning hard to reach areas, 50 pipe cleaners, 100 cleaning swabs and 3 microfiber gun towels. Clean your lens with the included lens brush; dust brush also included.



**WHAT'S IN THE BOX**

Cleans Rifles, Pistols & Shotguns  
 from .22/.223 cal to 12 GA

9 Bronze Bore Brushes

9 Bore Mops

8 Jags

12 GA & 20 GA Felt Pads (12 each)

Sectional Rods for Rifle/Shotgun & Pistol

MC-7 Bore Cleaner (4 oz)

FP-10 Lubricant Elite® CLP (0.5oz & 4oz)  
 & Precision Applicator Tips

All-Weather Grease (10cc)

Rust Prevent (6oz)

1" and 2.5" square patches (100 each)

3 All-Purpose Receiver Brushes  
 (Bronze, Nylon & Stainless Steel)

50 Pipe Cleaners & 100 Cleaning Swabs

3 Microfiber Gun Towels

Lens Brush & Dust Brush

**SECTIONAL ROD KITS**

Shooter's Choice cleaning kits contain quality brass components that won't damage your firearm while cleaning. Get everything you need to clean your firearms in one place with these kits, from brushes, mops, patches and jags to all purpose brushes that aid in fine cleaning. A bottle of FP-10 Lubricant Elite® CLP is also included to keep your firearm properly lubricated and operating smoothly.

**RIFLE**

.22 cal	#SHF-SRS-22
Cleans .22 cal, .223 cal / 5.56mm	
.270 cal	#SHF-SRS-270
Cleans .270 cal, 6.8mm, 7mm	
6.5mm	#SHF-SRS-65
Cleans .243 cal - 6.5mm	
.30 cal	#SHF-SRS-30
Cleans .30, .30-06, .30-30, .303, .308 cal, .300 Win Mag, .32 cal, 7.62mm, 8mm	

**PISTOL**

9mm	#SHF-SRS-9MM
.22 cal	#SHF-SRS-22P <small>NEW RELEASE</small>
.40 cal	#SHF-SRS-40
.45 cal	#SHF-SRS-45

**SHOTGUN**

20 GA	#SHF-SRS-20
12 GA	#SHF-SRS-12

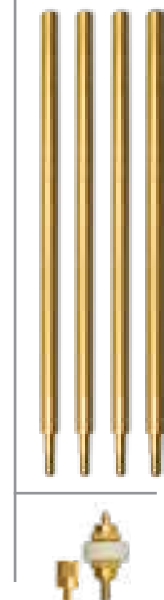

**WHAT'S IN THE KIT**

Components vary per sku

**ALL KITS INCLUDE**

Bronze Bore Brush

Bore Mop

Pierce Point Jag

Swivel Handle

8-32 Adapter

FP-10 Lubricant Elite®  
 CLP (0.5oz)

Square patches (10)

All-Purpose Receiver Brush

**RIFLE KITS**

4 sectional rods

**SHOTGUN KITS**

Shotgun Adapter

Shotgun Pierce Point Jag  
 with Felt Pad





### NYLON ALL PURPOSE BRUSHES

Nylon All-Purpose Receiver Brushes are double ended with one end for large surface scrubbing and the smaller end for precision cleaning. With nylon bristles, these brushes remove carbon and powder residue but won't scratch your firearm finish. Great for everyday use and can be used on a multitude of surfaces including wood. The brush handles are available in the signature Shooter's Choice red. Available in 3 count pack and 20 count canister.

3 ct.	#SHF-316R-3	20 ct.	#SHF-316R-20
-------	-------------	--------	--------------



LARGE SURFACE SCRUBBING



PRECISION CLEANING

### UNIVERSAL BORE GUIDE

#SHF-BG-U

The Universal Bore Guide offers an easier and safer clean by aiding in the alignment of your cleaning rod with the barrel of your firearm. Proper rod alignment prevents bowing and bending which can damage the bore. The built-in solvent port reduces the chance of spilling and wasting solvent, which could ruin the finish of your firearm. The Shooter's Choice Universal Bore Guide also includes a collar designed for AR style rifles, which creates a tighter fit and additional support of the upper receiver while cleaning your rifle. Fits most centerfire and bolt-action rifles.



PROPER ROD ALIGNMENT



SOLVENT PORT



AR ADAPTER COLLAR

### 36" SOLID RODS

The Shooter's Choice 36" one piece cleaning rod is made in the USA and designed to offer an easy and effective way to clean your firearms. Available in three finishes for precision cleaning with American quality and durability that won't scratch or damage your barrel. The full size handle with steel ball bearings allows the rod to turn with the rifling of the barrel to remove fouling with your choice of Shooter's Choice components from jags and patches to bore mops and brushes. The rod tip is outfitted with a standard 8-32 thread.

Cleans .22 cal and larger firearms • 36" Brass Solid Rod - .203 diameter • Ball Bearing Handle • 8-32 threads  
Full size handle for improved grip and easy cleaning • Hanging hole for convenient storage

Stainless Steel Coated Rod #SHF-SROD-22SC

Stainless Steel Rod #SHF-SROD-22S

Brass Rod #SHF-SROD-22B

### SQUARE COTTON PATCHES

Size	Item #	QTY.
1"	#SHF-914-500	500
2.5"	#SHF-917-100	100
3"	#SHF-919SQ-100	100



### MICROFIBER TOWEL 3 PACK

SHF-3502-RD-3

Reusable gun towels recommended for use on firearms, tools, knives and optics. Soft and absorbent, they easily clean a variety of surfaces without leaving behind lint and debris. Towel measures 12"x27.5"

### BRONZE BORE BRUSHES AND MOPS

Caliber	Thread	Bore Brush Item #	Bore Mop Item #	Cleans
.22 cal	8-32	#SHF-322-3B	#SHF-3M22	3" .22 Rimfire, .22-250, .233 cal, 5.56mm
.25 cal	8-32	#SHF-325-3B	#SHF-3M25	3" .243, .25 cal, 6mm, 6.5mm
.270 cal	8-32	#SHF-270-3B	#SHF-3M27	3" .260, .270, .280, .284 cal, 6.8mm, 7mm
.30 cal	8-32	#SHF-330-3B	#SHF-3M30	3" .30, .30-06, .30-30, .303, .308 cal, .300 Win Mag, .32 cal, 7.62mm, 8mm
9MM	8-32	#SHF-9MM-2B	#SHF-2M38	2" .357 cal, .38 cal, 9mm
.40 cal	8-32	#SHF-340-2B	#SHF-2M40	2" .40 cal
.45 cal	8-32	#SHF-345-2B	#SHF-2M45	2" .45 cal
.410 GA	5/16-27	#SHF-410-3B	#SHF-3M410	3" .410 GA
20 GA	5/16-27	#SHF-520-3B	#SHF-3M20	3" 20 GA
12 GA	5/16-27	#SHF-512-3B	#SHF-3M12	3" 12 GA



### PIERCE POINTS JAGS

Caliber	Thread	Item #	Cleans
.22 cal	8-32	#SHF-J2243	.22 Rimfire, .233 cal, 5.56mm
.25 cal	8-32	#SHF-J256M	.243, .25 cal, 6mm, 6.5mm
.270 cal	8-32	#SHF-J277M	.260, .270, .280, .284 cal, 6.8mm, 7mm
.30 cal	8-32	#SHF-J30	.30, .30-06, .30-30, .303, .308 cal, .300 Win Mag, .32 cal, 7.62mm, 8mm
9MM	8-32	#SHF-J9MM	.357 cal, .38 cal, 9mm
.40 cal	8-32	#SHF-J40	.40, 10mm
.44 cal	8-32	#SHF-J44	.44 cal
.45 cal	8-32	#SHF-J45	.45 cal
20 GA	5/16-27	#SHF-J20	20 GA (includes 1 felt pad)
12 GA	5/16-27	#SHF-J12	12 GA (includes 1 felt pad)



### NEED TO RELOAD?

Please visit [shooters-choice.com](http://shooters-choice.com) to get the latest deals or to place an order.

### CARE TO SHARE?

We'd love to hear about your experiences with our products. Share your stories with #GritHappens or #ShootersChoice

## 23 dB Electronic Earmuffs

#FG-ES23E-BK

Electronic Pro Earmuffs that really do, do it all (except pull the trigger). Electronic earmuffs offer protection against harmful noise coupled with uninterrupted hearing of ambient noise - like range commands.

Slim low profile cups also feature a cutout for an improved cheek weld without sacrificing effectiveness. The adjustable headband ensures a proper fit and the soft band makes for a comfortable wear. The ear cups are composed of an ultra-comfortable gel and ensure a tight seal - even with glasses. Need to replace the cups? The snap in design makes it a breeze.

These ear muffs boast a Noise Reduction Rating (NRR) of 23dB. Plus the sound compression technology coupled with the omnidirectional microphones ensure maximum environmental sounds at a safe volume level. Boost ambient sound up to 5X while the 0.5 millisecond attack time is ultra-fast and offers uninterrupted hearing - it eliminates sound clipping of ambient noise after a gunfire so you don't miss important range commands.

The compact, folding earmuffs are easy to store at home or in your range bag. Powered by 2 AAA batteries (not included), the 4 hour auto shut off feature prolongs battery life. The on/off switch controls volume and an LED light indicates unit is powered on. An auxiliary input jack and included cord for connecting to phone or other devices.



## Ranger - 22 dB Bluetooth Earmuffs

#FG-ES22B-BK

**Hearing protection. Sound enhancement. Bluetooth Connection. Sounds like a win-win-win. The EarShield Electronic Earmuff with Bluetooth offers up this triple combo in a sleek, compact ear muff.**

**Hearing Protection.** These slim, low profile muffs with adjustable headband boast a 22dB noise reduction rating. Additionally, they have a fast attack time of 0.01 second for optimal noise blocking over 82dB while minimizing interruption of ambient hearing. They feature sound activated compression & omnidirectional microphone technology for maximum environmental sounds at a safe volume level.

**Sound Enhancement.** With sound activated compression & omnidirectional microphone technology, these ear muffs deliver maximum environmental sounds at a safe volume level. They offer up to 5x amplification to hear even the quietest of sounds and are frequency tuned for national sound clarity.

**Bluetooth Connection.** Utilizing the latest in Bluetooth technology, you can make & receive calls or listen to music from your device. Separate volume control dials for Bluetooth and ambient sound deliver the exact volume desired for each function. An auxiliary input jack and cord are included for those who wish to keep a wired connection from the ear muffs to their device.

**Additional Features.** Ear cups are soft & comfortable for extended wear and are also easily replaceable with the snap-in design. These ear muffs are compact and foldable - making them easy to transport or store. They are powered by 2 AAA batteries, not included.

## 26 dB Passive Earmuffs

#FG-ES26P-BK

You demand a lot from your hearing protection - not only does it need to protect your hearing, but it needs to be comfortable enough for all day wear and withstand the rigor you put it through. EarShield's got you covered with the Passive Earmuff. The folding design easily stores in your range bag and the soft ear cups & band make for a comfortable wear. The slim, low profile cups of the ear muffs are not only a sleek design but also limit interference with activities such as shooting. The noise reduction rating is 26dB NRR.



## Scout 31 dB Earcuffs

#FG-ESH-31

**Eliminates stock interference • Cool and comfortable • Adjustable to fit any shooter**  
**No batteries required Lightweight and collapsible**

Otis Technology presents a smarter way to protect your hearing while improving your response to range commands and other communication. Soft ear buds form a seal around the outer ear canal and connect to the unique sound reduction chambers. Because sound energy travels the path of least resistance, high-intensity sounds, like gunfire, funnel into the wider sound reduction chambers and away from your narrow ear canals. The chamber dampens, refracts and cancels harmful waves to produce a safe volume across all frequencies. So you can hear important safety signals or conversations without removing the Ear Shield.

\*Also available in 26 dB Earcuffs

#FG-ESH-26

**Scout Replacement Cuffs (4)**

#FG-ESH-C

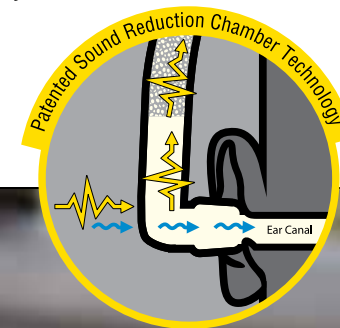

## 33 dB Foam Earplugs

#FG-ESH-FPNC50

Simple, effective and portable, these Premium Foam Earplugs are perfect for the range, workshop, garage and more. Toss a 50 pair can in your range bag and you'll always have ear protection. As a bonus you'll also get a water-proof screw top canister that holds 2 Earplugs that can clip onto any keyring or strap.





6987 Laura Street, Lyons Falls, NY 13368 | 1.800.OTISGUN | OTISTEC.COM

AD-4015 | REV21108

