

**PIPER**



***CHEROKEE 'D'***  
**OWNER'S HANDBOOK**

*the*  
**CHEROKEE 'D'**

**PA-28-180**

**Owner's Handbook**

**PIPER**

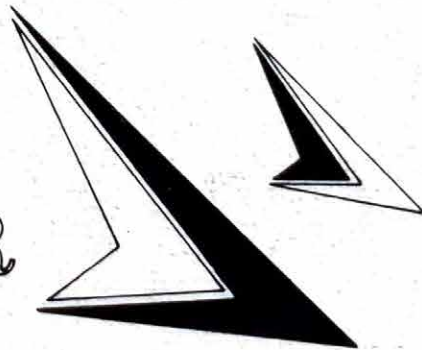

**Piper Aircraft Corporation, Vero Beach, Florida  
U. S. A.**

*R. D. REGINA*

*Assurance that the airplane is in an airworthy condition is the responsibility of the owner. The pilot in command is responsible for determining that the airplane is safe for flight. The pilot is also responsible for remaining within the operating limitations outlined by the Flight Manual, instrument markings, and placards.*

*If an inconsistency of information exists between this handbook and the Flight Manual approved by the FAA, the Flight Manual shall be the authority.*

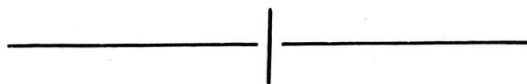

Additional copies of this manual, Part No. 753 765, may be obtained from your Piper Dealer.

Published by  
**PUBLICATIONS DEPARTMENT**  
Piper Aircraft Corporation  
753 765  
Issued: November 1967  
Revised: April 1968  
Revised: November 1968



**SECTION I**  
**SPECIFICATIONS**

Performance . . . . .	1
Weights . . . . .	2
Power Plant . . . . .	2
Fuel and Oil . . . . .	2
Baggage . . . . .	2
Dimensions . . . . .	3
Landing Gear . . . . .	3

**SECTION I  
SPECIFICATIONS**

**PERFORMANCE**

Performance figures are for airplanes equipped for cross-country transportation and flown at gross weight under standard conditions at sea level or stated altitude. Any changes in equipment may result in changes in performance.

Take-off Run (maximum effort, 25° flap) (ft)	720
Take-off over 50-ft barrier (maximum effort, 25° flap) (ft)	1625
Best Rate of Climb Speed (mph)	85
Rate of Climb (ft per min)	750
Service Ceiling (ft)	13,000
Absolute Ceiling (ft)	15,000
Top Speed (mph)	152
Optimum Cruising Speed (75% power, optimum altitude) (mph)	143
Cruising Range (75% power, optimum altitude) (mi)	725
Optimum Cruising Range (55% power, optimum altitude) (mi)	845
Stalling Speed (flaps down) (mph)	57
Stalling Speed (flaps up) (mph)	67
Landing Roll (flaps down) (ft)	600
Landing Roll over 50-ft barrier (ft)	1150

## SPECIFICATIONS (cont):

## WEIGHTS

Gross Weight (lbs)	
Empty Weight (Standard) (lbs)	2400
USEFUL LOAD (Standard) (lbs)	1294
	1106

## POWER PLANT

Engine (Lycoming)	O-360-A4A
Rated Horsepower	180
Rated Speed (rpm)	2700
Bore (in.)	5.125
Stroke (in.)	4.375
Displacement (cu in.)	361.0
Compression Ratio	8.5:1
Dry Weight (lbs)	285
Propeller	M76EMMS60

## FUEL AND OIL

Fuel Capacity (U.S. gal)	50	$\times 6 = 300\#$
Oil Capacity (qts)	8	$= 15\#$
Fuel, Aviation Grade (min octane)	91/96	

## BAGGAGE

Maximum Baggage (lbs)	200
Baggage Space (cu ft)	17
Baggage Door Size (in.)	20 x 22

SPECIFICATIONS (cont):

DIMENSIONS

Wing Span (ft)	30
Wing Area (sq ft)	160
Wing Loading (lbs per sq ft)	15.0
Length (ft)	23.5
Height (ft)	7.3
Power Loading (lbs per hp)	13.3

LANDING GEAR

Wheel Base (ft)	6.2
Wheel Tread (ft)	10
Tire Pressure (psi) Nose	24
Main	24
Tire Size	Nose (4 ply rating) 6.00 x 6
	Main (4 ply rating) 6.00 x 6

*4 gts/gal = 7.5 #*



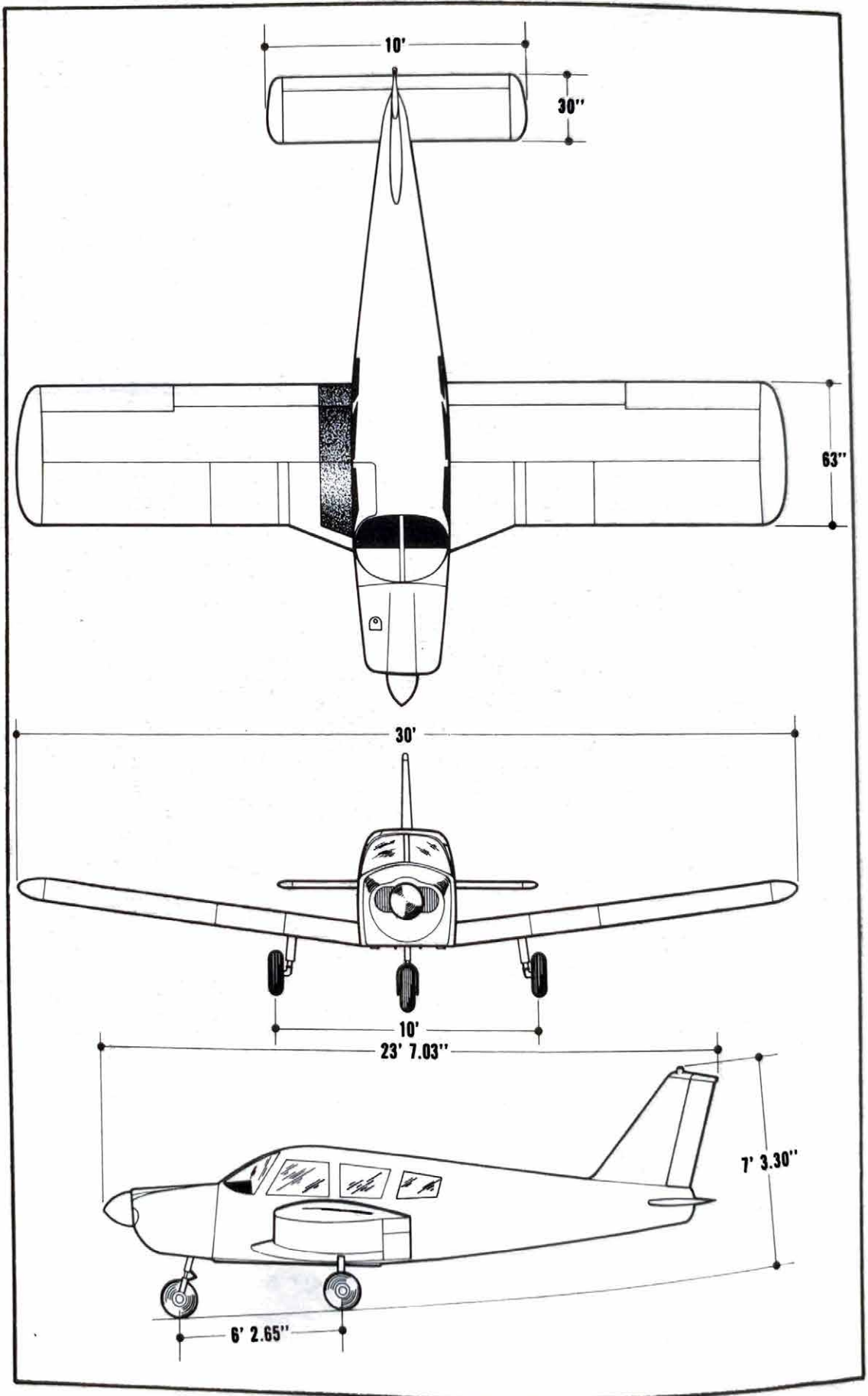

**SECTION II**  
**DESIGN INFORMATION**

Engine and Propeller . . . . .	5
Structures . . . . .	5
Landing Gear . . . . .	6
Control Systems . . . . .	7
Fuel System . . . . .	7
Electrical System . . . . .	9
Heating and Ventilating System . . . . .	13
Cabin Features . . . . .	13

## SECTION II

### DESIGN INFORMATION

#### ENGINE AND PROPELLER

The Cherokee "D" is powered by a Lycoming O-360-A4A four cylinder, direct drive, horizontally opposed engine rated at 180 HP at 2700 RPM. It is furnished with a starter, 60 ampere 12 volt alternator, shielded ignition, vacuum pump drive, fuel pump, and a dry, automotive type carburetor air filter.

The exhaust system is of the cross-over type to reduce back pressure and improve performance. It is made entirely from stainless steel and is equipped with dual mufflers. A heater shroud around the mufflers is provided to supply heat for the cabin and windshield defrosting.

The Sensenich M76EMMS60 fixed-pitch propeller is made from a one-piece alloy forging.

#### STRUCTURES

All structures are of aluminum alloy construction and are designed to ultimate load factors well in excess of normal requirements. All exterior surfaces are primed with etching primer and painted with acrylic enamel.

The wings are attached to each side of the fuselage by inserting the buttends of the respective main spars into a spar box carry-through which is an integral part of the fuselage structure, providing in effect a continuous main spar with splices at each side of the fuselage. There are also fore and aft attachments at

the rear spar and at an auxiliary front spar.

The wing airfoil section is a laminar flow type, NACA65<sub>2</sub>-415 with the maximum thickness about 40% aft of the leading edge. This permits the main spar carry-through structure to be located under the rear seat providing unobstructed cabin floor space ahead of the rear seat.

## LANDING GEAR

The three landing gears use a Cleveland 6.00 x 6 wheel, the main wheels being provided with Cleveland single disc hydraulic brake assemblies, No. 30-55. All wheels use 6.00 x 6 four ply tires with tubes.

The nose gear is steerable through a 44 degree arc by use of the rudder pedals. A spring device is incorporated in the rudder pedal torque tube assembly to aid in rudder centering and to provide rudder trim. The nose gear steering mechanism also incorporates a hydraulic shimmy dampener.

The three struts are of the air-oil type, with the normal extension being 3.25 inches for the nose gear and 4.50 inches for the main gear.

The standard brake system for the Cherokee consists of a hand lever and master cylinder which is located below and behind the left center of the instrument sub-panel. The brake fluid reservoir is installed on the top left front face of the firewall. The parking brake is incorporated in the master cylinder and is actuated by pulling back on the brake lever, depressing the knob attached to the handle and releasing the brake lever. To release the parking brake, pull back on the lever to disengage the catch mechanism and allow the handle to swing forward.

Optional toe brakes are available to supplement the standard hand lever and parking brake system.

## CONTROL SYSTEMS

Dual controls are provided as standard equipment with a cable system used between the controls and the surfaces. The horizontal tail is of the Flying Tail type (stabilator), with a trim tab mounted on the trailing edge of the stabilator to reduce the control system forces. This tab is actuated by a control wheel on the floor between the front seats. The stabilator provides extra stability and controllability with less size, drag and weight than conventional tail surfaces. The ailerons are provided with a differential action which tends to reduce adverse yaw in turning maneuvers, and which also reduces the amount of coordination required in normal turns. A rudder trim adjustment is mounted on the right side of the pedestal below the throttle quadrant and permits directional trim as needed in flight.

The flaps are manually operated, balanced for light operating forces and spring-loaded to return to the up position. A past-center lock incorporated in the actuating linkage holds the flap when it is in the up position so that it may be used as a step on the right side. The flap will not support a step load except when in the full up position, so it must be completely retracted when used as a step. The flaps have three extended positions: 10, 25 and 40 degrees.

## FUEL SYSTEM

Fuel is stored in two twenty-five gallon tanks which are secured to the leading edge structure of each wing by screws and nut plates. This allows easy removal for service or inspection.

An auxiliary electric fuel pump is provided in case of failure of the engine-driven pump. The electric pump should be on for all take-offs and landings, and when switching tanks. The pump switch is located in the switch panel above the throttle quadrant.

Each tank has an individual quick drain located at the bottom, inboard rear corner, and should be drained to check for

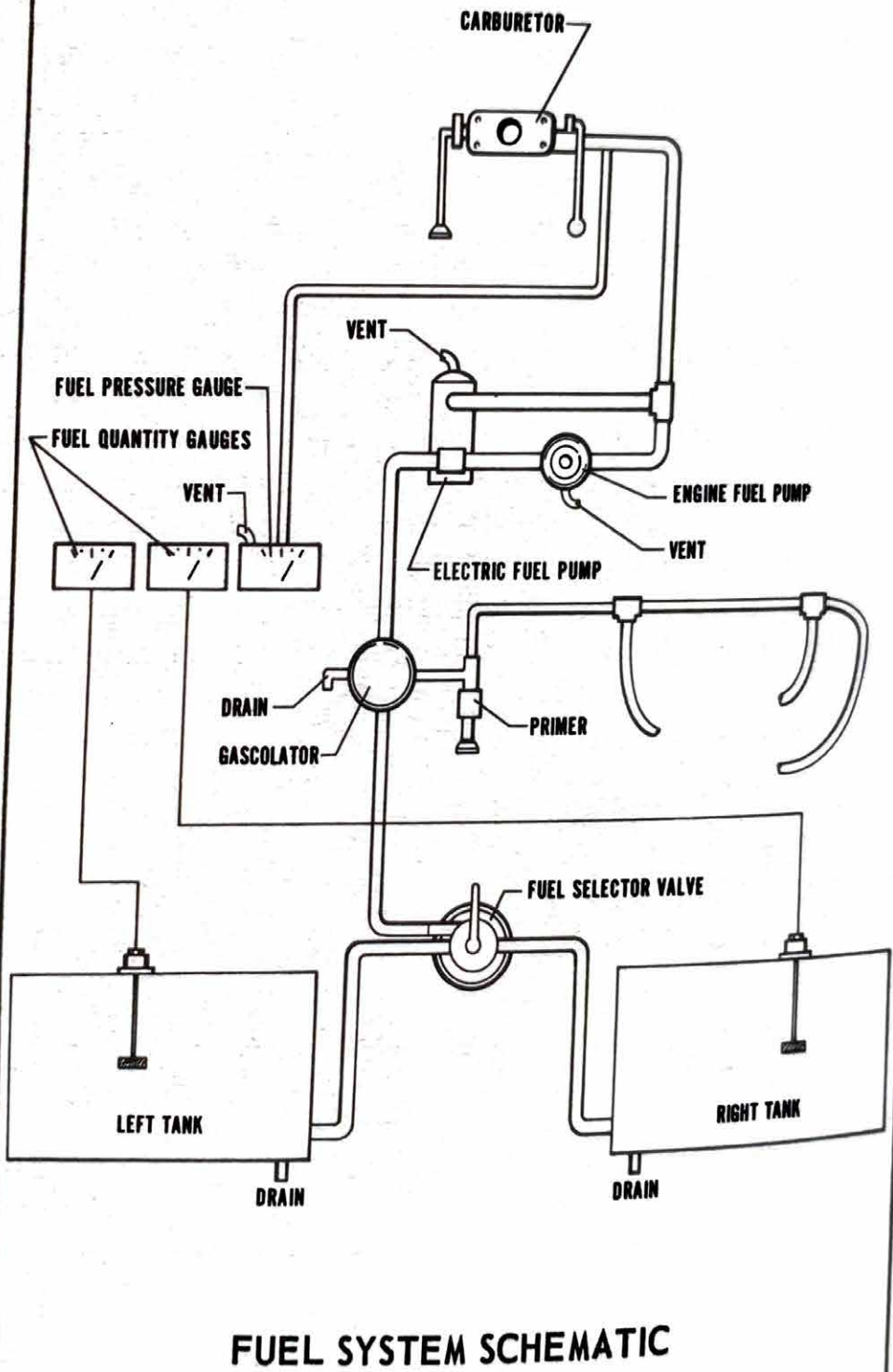

FUEL SYSTEM SCHEMATIC

water before each flight. The fuel strainer, which is also equipped with a quick drain, is located on the front lower left corner of the firewall. This strainer should be drained regularly to check for water or sediment accumulation.

Fuel quantity and pressure are indicated on gauges located in a cluster on the left side of the instrument panel.

**ELECTRICAL SYSTEM**

The electrical system includes a 12 volt 60 amp alternator, battery, voltage regulator, overvoltage relay and master switch relay. The battery is mounted in a stainless steel box immediately aft of the baggage compartment. The regulator and overvoltage relay are located on the forward left side of the fuselage behind the instrument panel.

Electrical switches are located on the right center instrument panel, and the circuit breakers are located on the lower right instrument panel. A rheostat-switch on the left side of the switch panel controls the navigation lights and the dome instrument light. It also dims the dome light. The similar switch on the right side controls and dims the panel lights.

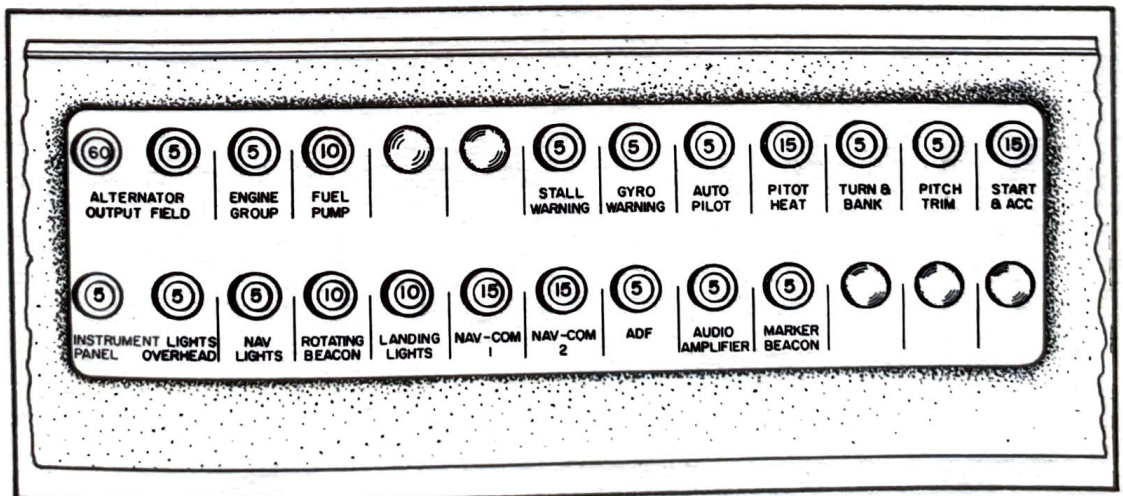

**Circuit Breaker Panel**

Standard accessories include a starter, electric fuel pump, stall warning indicator, cigar lighter, fuel gauge and ammeter. The navigation lights, anti-collision light, landing light, instrument lighting and cabin dome light are optional. Circuits will handle an entire complement of communications and navigational equipment.

The alternator system offers many advantages over the generator system both in operation and maintenance. The main advantage is full electrical power output at lower engine RPM. This is a great improvement for radio and electrical equipment operation. Since the alternator output is available at all times, the battery will be charging for a greater percentage of use. This will make cold-morning starting easier.

Unlike previous generator systems, the ammeter does not indicate battery discharge; rather it displays in amperes the load placed on the alternator. With all electrical equipment off (except master switch) the ammeter will be indicating the amount of charging current demanded by the battery. As each item of electrical equipment is turned on, the current will increase to a total appearing on the ammeter. This total includes the battery. The maximum continuous load for night flight, with radios on, is about 30 amperes. This 30 ampere value, plus approximately two amperes for a fully charged battery, will appear continuously under these flight conditions. The amount of current shown on the ammeter will tell immediately if the alternator system is operating normally, as the amount of current shown should equal the total amperage drawn by the equipment which is operating.

If no output is indicated on the ammeter during flight, reduce the electrical load by turning off all unnecessary electrical equipment. Check both 5 ampere field breaker and 60 ampere output breaker and reset if open. If neither circuit breaker is open, turn off the master switch for 30 seconds to reset the overvoltage relay. If ammeter continues to indicate no output, maintain minimum electrical load and terminate flight as soon as practical.

Maintenance on the alternator should prove to be a minor factor. Should service be required, contact the local Piper Dealer.



# CHEROKEE "D"

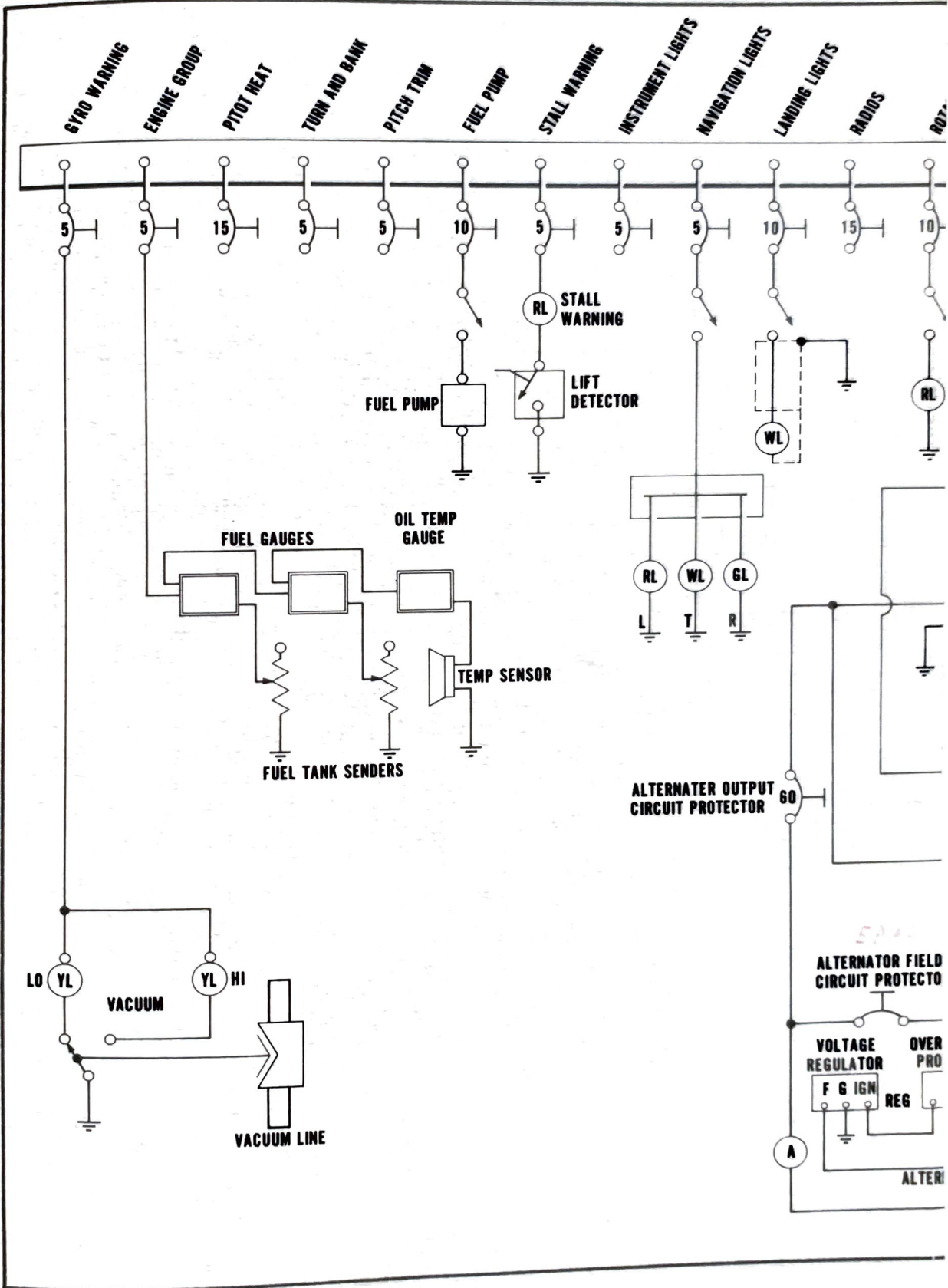

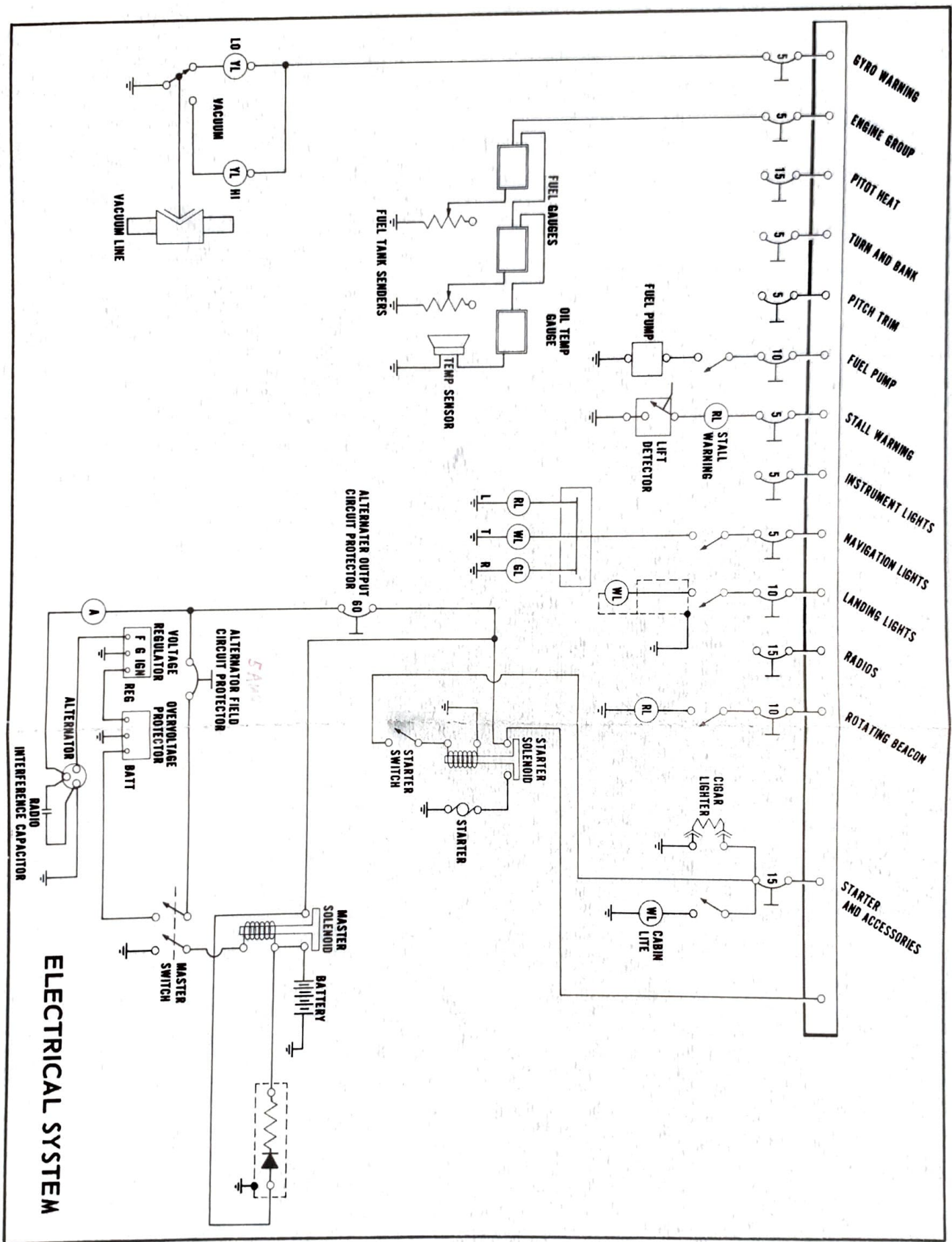

ELECTRICAL SYSTEM



## HEATING AND VENTILATING SYSTEM

Heat for the cabin interior and the defroster system is provided by a heater muff attached to the exhaust system. The amount of heat desired can be regulated with the controls located on the far right side of the instrument panel.

Fresh air inlets are located in the leading edge of the wing at the intersection of the tapered and straight sections. A large adjustable outlet is located on the side of the cabin near the floor at each seat location. Cabin air is exhausted through an outlet located below the rear seat.

## CABIN FEATURES

The instrument panel of the Cherokee is designed to accommodate the customary advanced flight instruments and the normally required power plant instruments. The Artificial Horizon and Directional Gyro are vacuum operated through use of a vacuum pump installed on the engine, while the Turn and Bank instrument is electrically operated. Above the Attitude Gyro are two lights which indicate high or low vacuum. A natural separation of the flight group and the power group is provided by placing the flight group in the upper instrument panel and the power group in the center and lower instrument panels. The radios and circuit breakers are on the right hand instrument panel, and extra circuits are provided for a complete line of optional radio equipment.

The cabin interior includes a pilot storm window, two sun visors, ash trays, two map pockets, and pockets on the backs of each front seat. The front seats are adjustable fore and aft for pilot-passenger comfort and ease of entry and exit. Recessed arm rests are also provided for the front seats.

The 17 cubic foot baggage area may be reached from the cabin or through a large 20 x 22 inch outside door.

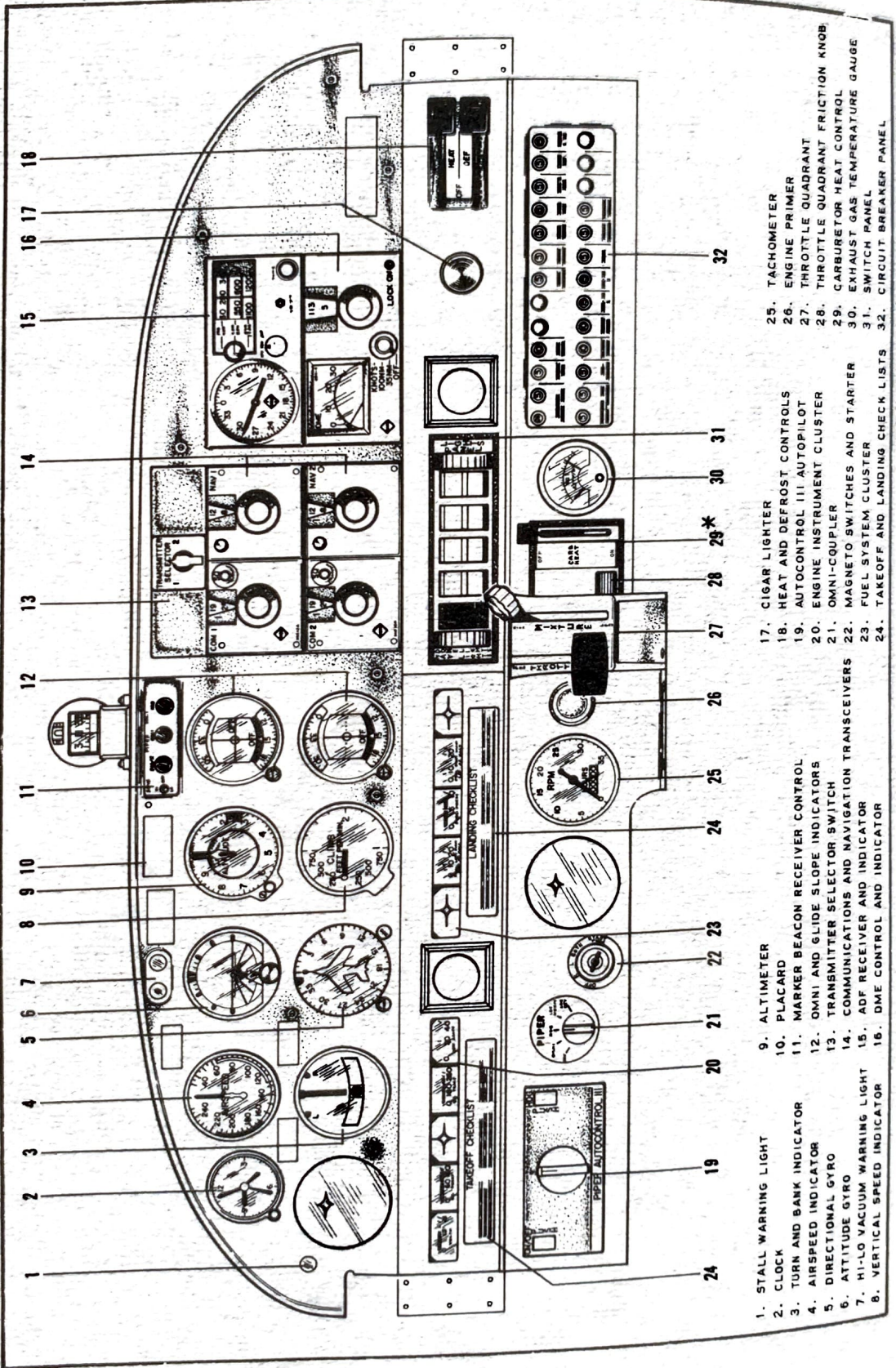

- 1. STALL WARNING LIGHT
- 2. CLOCK
- 3. TURN AND BANK INDICATOR
- 4. AIRSPEED INDICATOR
- 5. DIRECTIONAL GYRO
- 6. ATTITUDE GYRO
- 7. HI-LO VACUUM WARNING LIGHT
- 8. VERTICAL SPEED INDICATOR
- 9. ALTIMETER
- 10. PLACARD
- 11. MARKER BEACON RECEIVER CONTROL
- 12. OMNI AND GLIDE SLOPE INDICATORS
- 13. TRANSMITTER SELECTOR SWITCH
- 14. COMMUNICATIONS AND NAVIGATION TRANSCEIVERS
- 15. ADF RECEIVER AND INDICATOR
- 16. DME CONTROL AND INDICATOR
- 17. CIGAR LIGHTER
- 18. HEAT AND DEFROST CONTROLS
- 19. AUTOCONTROL III AUTOPILOT
- 20. ENGINE INSTRUMENT CLUSTER
- 21. OMNI-COUPLER
- 22. MAGNETO SWITCHES AND STARTER
- 23. FUEL SYSTEM CLUSTER
- 24. TAKEOFF AND LANDING CHECK LISTS
- 25. TACHOMETER
- 26. ENGINE PRIMER
- 27. THROTTLE QUADRANT
- 28. THROTTLE QUADRANT FRICTION KNOB
- 29. CARBURETOR HEAT CONTROL
- 30. EXHAUST GAS TEMPERATURE GAUGE
- 31. SWITCH PANEL
- 32. CIRCUIT BREAKER PANEL

**NOTE**

\*In aircraft with Serial Nos. 28-4378 to 28-5042 carburetor heat is ON when indicator is in the UP position. From Serial Nos. 28-5043 and up, carburetor heat is ON when indicator is in the DOWN position.

## SECTION III

### OPERATING INSTRUCTIONS

Preflight . . . . .	16
Starting Engine . . . . .	17
Warm-Up and Ground Check . . . . .	19
Take-Off . . . . .	19
Climb . . . . .	20
Stalls . . . . .	20
Cruising . . . . .	21
Approach and Landing . . . . .	22
Stopping Engine . . . . .	23
Engine Power Loss . . . . .	23
Mooring . . . . .	24
Weight and Balance . . . . .	24
Operating Tips . . . . .	24

SECTION III  
OPERATING INSTRUCTIONS

PREFLIGHT

1. Master switch and ignition OFF.
2. a. Check for external damage and operational interference of control surfaces or hinges.  
b. Insure that wings and control surfaces are free of snow, ice or frost.
3. a. Visually check fuel supply and secure caps.

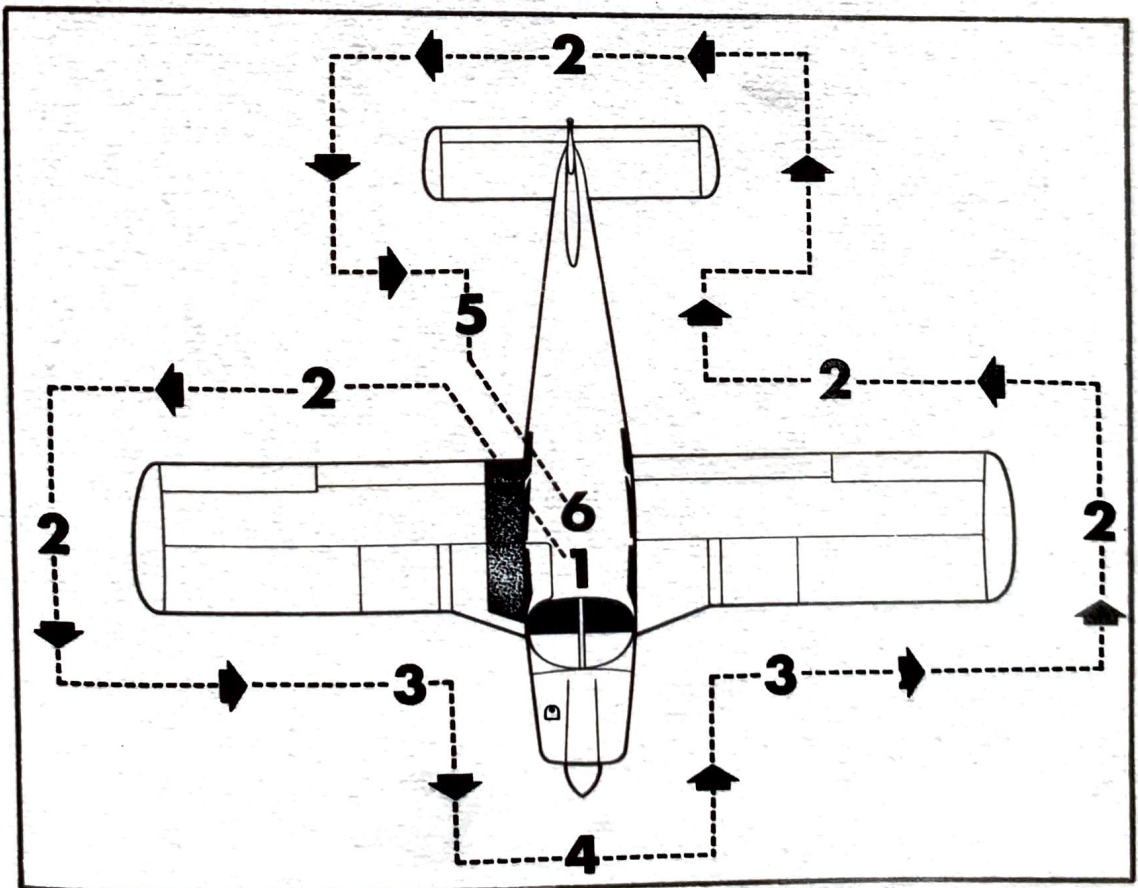



- b. Drain fuel tank sumps (two).
  - c. Drain fuel system sump (left side of aircraft).
  - d. Check that fuel system vents are open.
  - e. Check main landing gear shock struts for proper inflation (approximately 4.50 inches showing).
  - f. Check tires for cuts, wear and proper inflation.
4. a. Check windshield for cleanliness.
  - b. Check propeller and spinner for defects or nicks.
  - c. Check for obvious fuel or oil leaks.
  - d. Check oil level (insure dipstick is properly seated).
  - e. Check cowling and inspection covers for security.
  - f. Check nose wheel tire for inflation and wear.
  - g. Check nose gear shock strut for proper inflation (approximately 3.25 inches showing).
  - h. Check for foreign matter in air inlet.
5. a. Stow tow-bar and control locks if used.
  - b. Check baggage for storage and security.
  - c. Close and secure the baggage compartment door.
6. a. Upon entering airplane, check that all primary flight controls operate properly.
  - b. Close and secure cabin door.
  - c. Check that required papers are in order and in the airplane.

## STARTING ENGINE

1. Set brakes ON.
2. Set the carburetor heat control in the full COLD position.
3. Select the desired tank with fuel selector valve.

### Starting Engine When Cold:

1. Open throttle approximately 1/4 inch.
2. Turn the master switch ON.
3. Turn the electric fuel pump ON.
4. Move the mixture control to FULL RICH.

5. Engage the starter by rotating magneto switch clockwise and pressing in.

6. When the engine fires, advance throttle to desired setting. If the engine does not fire within five to ten seconds, disengage starter and prime with one to three strokes of the priming pump. Repeat the starting procedure.

#### Starting Engine When Hot:

1. Open the throttle approximately 1/2 inch.
2. Turn the master switch ON.
3. Turn the electric fuel pump ON.
4. Put mixture control in IDLE CUT-OFF.
5. Engage the starter by rotating magneto switch clockwise and pressing in. When the engine fires, advance the mixture control and move the throttle to desired setting.

#### Starting Engine When Flooded:

1. Open the throttle full.
2. Turn the master switch ON.
3. Turn the electric fuel pump OFF.
4. Put mixture control in IDLE CUT-OFF.
5. Engage the starter by rotating magneto switch clockwise and pressing in. When the engine fires, advance the mixture control and retard the throttle.

When the engine is firing evenly, advance the throttle to 800 RPM. If oil pressure is not indicated within thirty seconds, stop the engine and determine the trouble. In cold weather it will take a few seconds longer to get an oil pressure indication. If the engine has failed to start, refer to the "Lycoming Operating Handbook, Engine Troubles and Their Remedies."

Starter manufacturers recommend that cranking periods be limited to thirty seconds with a two minute rest between cranking periods. Longer cranking periods will shorten the life of the starter.

## SECTION III

## WARM-UP AND GROUND CHECK

Warm-up the engine at 800 to 1200 RPM for not more than two minutes in warm weather, four minutes in cold weather. Avoid prolonged idling at low RPM as this practice may result in fouled spark plugs. If necessary to hold before take-off, it is recommended that the engine be idled at 1200 RPM.

The magnetos should be checked at 1800 RPM and the drop off on either magneto should not exceed 125 RPM and should be within 50 RPM of the other. Prolonged operation on one magneto should be avoided.

Check both the oil temperature and pressure. The temperature may be low for some time if the engine is being run for the first time of the day, but as long as the pressure is within limits the engine is ready for take-off.

Carburetor heat should also be checked prior to take-off to be sure that the control is operating properly, and to clear any ice which may have formed during taxiing.

The electric fuel pump should be turned off momentarily during ground check to make sure that the engine-driven pump is operating. The electric fuel pump should be on during take-off to prevent loss of power should the engine-driven pump fail. The engine is warm enough for take-off when the throttle can be opened without the engine faltering. Do not take off with a dead battery as some voltage is needed to excite the alternator.

## TAKE-OFF

Just before take-off the following items should be checked:

- |                            |                                 |
|----------------------------|---------------------------------|
| 1. Fuel - on proper tank   | 6. Quadrant friction knob - set |
| 2. Electric fuel pump - ON | 7. Flaps - set                  |
| 3. Engine gauges - checked | 8. Trim tab - set               |
| 4. Carburetor heat - OFF   | 9. Controls - free              |
| 5. Mixture - set           | 10. Door - latched              |

The take-off technique is conventional for the Cherokee. The tab should be set slightly aft of neutral, with the exact setting determined by the loading of the aircraft. Allow the airplane to accelerate to 50 to 60 MPH, then ease back on the wheel enough to let the airplane fly itself off the ground. Premature raising of the nose, or raising it to an excessive angle will result in a delayed take-off. After take-off let the aircraft accelerate to the desired climb speed by lowering the nose slightly.

Take-offs are normally made with flaps up. However, for short field take-offs, and for take-offs under difficult conditions such as deep grass or on a soft surface, distances can be reduced appreciably by lowering flaps to 25°.

## CLIMB

The best rate of climb at gross weight will be obtained at 85 MPH. The best angle of climb may be obtained at 74 MPH. At lighter than gross weight these speeds are reduced somewhat. For climbing en route a speed of 100 MPH is recommended. This will produce better forward speed and increased visibility over the nose during the climb.

## STALLS

All controls are effective at speeds down through the stalling speed, and stalls are gentle and easily controlled.

Stall speed chart on following page is at gross weight. Stall speeds at lower weights will be correspondingly less.

## WARM-UP AND GROUND CHECK

Warm-up the engine at 800 to 1200 RPM for not more than two minutes in warm weather, four minutes in cold weather. Avoid prolonged idling at low RPM as this practice may result in fouled spark plugs. If necessary to hold before take-off, it is recommended that the engine be idled at 1200 RPM.

The magnetos should be checked at 1800 RPM and the drop off on either magneto should not exceed 125 RPM and should be within 50 RPM of the other. Prolonged operation on one magneto should be avoided.

Check both the oil temperature and pressure. The temperature may be low for some time if the engine is being run for the first time of the day, but as long as the pressure is within limits the engine is ready for take-off.

Carburetor heat should also be checked prior to take-off to be sure that the control is operating properly, and to clear any ice which may have formed during taxiing.

The electric fuel pump should be turned off momentarily during ground check to make sure that the engine-driven pump is operating. The electric fuel pump should be on during take-off to prevent loss of power should the engine-driven pump fail. The engine is warm enough for take-off when the throttle can be opened without the engine faltering. Do not take off with a dead battery as some voltage is needed to excite the alternator.

## TAKE-OFF

Just before take-off the following items should be checked:

1. Fuel - on proper tank
2. Electric fuel pump - ON
3. Engine gauges - checked
4. Carburetor heat - OFF
5. Mixture - set
6. Quadrant friction knob - set
7. Flaps - set
8. Trim tab - set
9. Controls - free
10. Door - latched

## STALL SPEED TABLE

Angle of Bank	Flaps 40°	Flaps Retracted
0°	57 MPH	67 MPH
20°	59 MPH	69 MPH
40°	65 MPH	77 MPH
60°	81 MPH	95 MPH

Power Off – Gross Weight 2400 lbs.

## CRUISING

The cruising speed is determined by many factors including power setting, altitude, temperature, loading and equipment installed on the airplane.

The normal cruising power is 75% of the rated horsepower of the engine. True airspeeds which may be obtained at various altitudes and power settings can be determined from the charts in Section IV of this handbook.

Use of the mixture control in cruising flight reduces fuel consumption significantly, especially at higher altitudes. The mixture should be leaned during cruising operation above 5000 feet altitude and at pilot's discretion at lower altitudes when 75% power or less is being used. If any doubt exists as to the amount of power being used, the mixture should be in the FULL RICH position for all operations under 5000 feet.

To lean the mixture, pull the mixture control until the engine becomes rough, indicating that the lean mixture limit has been reached in the leaner cylinders. Then enrich the mixture by pushing the control towards the instrument panel until engine operation becomes smooth. The fuel flow meter will give a close approximation of the fuel being consumed.

If the airplane is equipped with the optional exhaust gas

temperature (EGT) gauge, a more accurate means of leaning is available to the pilot. For best power mixture, lean the mixture until the peak EGT is reached, then enrich the mixture until the temperature drops a minimum of 25° F. For best economy mixture, lean until the peak EGT is reached and continue to lean until the temperature drops a minimum of 25° F. Do not lean above 75% power.

In order to keep the airplane in best lateral trim during cruising flight, the fuel should be used alternately from each tank. It is recommended that one tank be used for one hour after take-off, then the other tank be used for two hours, then return to the first tank, which will have approximately one and one half hours of fuel remaining if the tanks were full at take-off. The second tank will contain approximately one half hour of fuel. Do not run tanks completely dry in flight.

## APPROACH AND LANDING

Before landing check list:

1. Fuel - on proper tank
2. Electric fuel pump - ON
3. Mixture - set
4. Flaps - set (115 MPH MAX)

The airplane should be trimmed to an approach speed of about 85 MPH with flaps up. The flaps can be lowered at speeds up to 115 MPH, if desired, and the approach speed reduced 3 MPH for each additional notch of flaps. Carburetor heat should not be applied unless there is an indication of carburetor icing, since the use of carburetor heat causes a reduction in power which may be critical in case of a go-around. Full throttle operation with heat on is likely to cause detonation.

The amount of flap used during landings and the speed of the aircraft at contact with the runway should be varied according to the landing surface and conditions of wind and airplane loading.

It is generally good practice to contact the ground at minimum possible safe speed consistent with existing conditions.

Normally, the best technique for short and slow landings is to use full flap and enough power to maintain the desired airspeed and approach flight path. Reduce the airspeed during flare out and contact the ground close to stalling speed. After ground contact hold the nose wheel off as long as possible. As the airplane slows down, drop the nose and apply the brakes. There will be less chance of skidding the tires if the flaps are retracted before applying the brakes. Braking is most effective when back pressure is applied to the control wheel, putting most of the airplane weight on the main wheels. In high wind conditions, particularly in strong crosswinds, it may be desirable to approach the ground at higher than normal speeds with partial or no flaps.

### STOPPING ENGINE

At the pilot's discretion, the flaps should be raised and the electric fuel pump turned off. After parking, the radios should be turned off and the engine stopped by pulling the mixture control to idle cut-off. The throttle should be left full aft to avoid engine vibration while stopping. Then the magneto and master switches should be turned off and the parking brake set.

### ENGINE POWER LOSS

The most common cause of engine power loss is mismanagement of the fuel. Therefore, the first step to take after engine power loss is to move the fuel selector valve to the tank not being used. This will often keep the engine running even if there is no apparent reason for the engine to stop on the tank being used.

*Turn fuel pump ON before switching tanks!*



If changing to another tank does not restore the engine:

1. Check fuel pressure and turn on electric fuel pump if off.
2. Push mixture control to full "RICH."
3. Check ignition switch. Turn to best operating magneto - left, right, or both.

## MOORING

The Cherokee should be moved on the ground with the aid of the nose wheel tow-bar provided with each plane and secured in the baggage compartment. Tie down ropes may be secured to rings provided under each wing and to the tail skid. The aileron and stabilator controls should be secured by looping the safety belt through the control wheel and pulling it tight. The rudder is held in position by its connections to the nose wheel steering and normally does not have to be secured. The flaps are locked when in the full up position and should be left retracted.

## WEIGHT AND BALANCE

It is the responsibility of the owner and pilot to determine that the airplane remains within the allowable weight vs. center of gravity envelope while in flight. For weight and balance data see the Airplane Flight Manual and Weight and Balance form supplied with each airplane.

## OPERATING TIPS

The following Operating Tips are of particular value in the operation of the Cherokee.

1. Learn to trim for take-off so that only a very light back pressure on the wheel is required to lift the airplane off the

ground.

2. The best speed for take-off is about 60 MPH under normal conditions. Trying to pull the airplane off the ground at too low an airspeed decreases the controllability of the airplane in event of engine failure.

3. Flaps may be lowered at airspeeds up to 115 MPH. To reduce flap operating loads, it is desirable to have the airplane at a slower speed before extending the flaps.

4. Before attempting to reset any circuit breaker, allow a two to five minute cooling off period.

5. Before starting the engine, check that all radio switches, light switches, and the pitot heat switch are in the off position so as not to create an overloaded condition when the starter is engaged.

6. The overvoltage relay is provided to protect the electronics equipment from a momentary overvoltage condition (approximately 16.5 volts and up), or a catastrophic regulator failure. In the event of a momentary condition, the relay will open and the ammeter will indicate "0" output from the alternator. The relay may be reset by switching the master switch to "OFF" for approximately one minute and then returning the master switch to "ON." If after recycling the master switch the condition persists, the flight may be continued on battery alone by monitoring the voltmeter and reducing battery load to a minimum.

NOTES

**SECTION IV**  
**PERFORMANCE CHARTS**

Take-off Distance vs Density Altitude . . . . .	27
Altitude Conversion Chart . . . . .	28
Rate of Climb vs Density Altitude . . . . .	29
Range vs Density Altitude . . . . .	30
True Airspeed and RPM vs Density Altitude . . . . .	31
Landing Distance vs Density Altitude . . . . .	32
Power Setting Table. . . . .	33

# PA-28-180 PIPER CHEROKEE

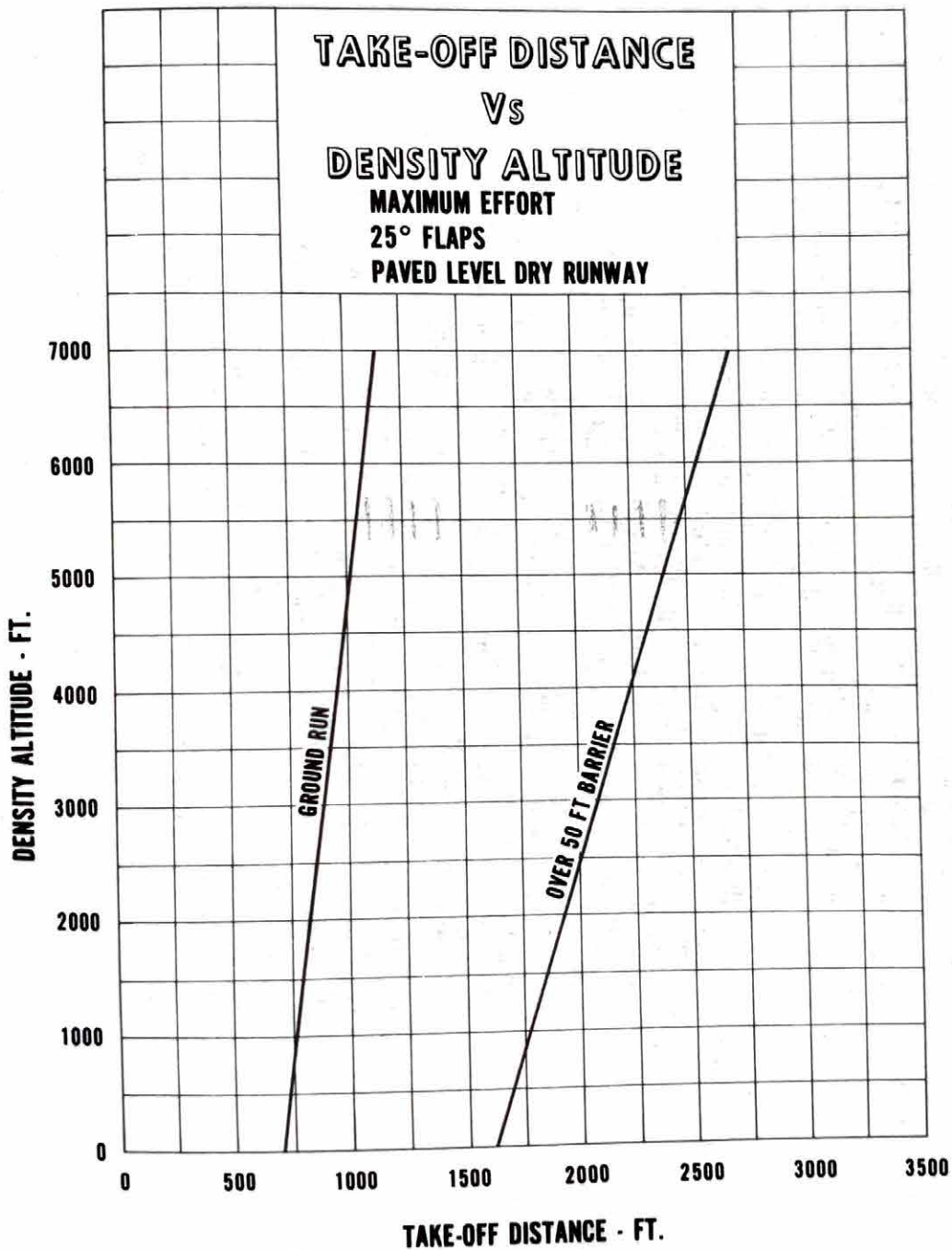

# PA-28-180 PIPER CHEROKEE

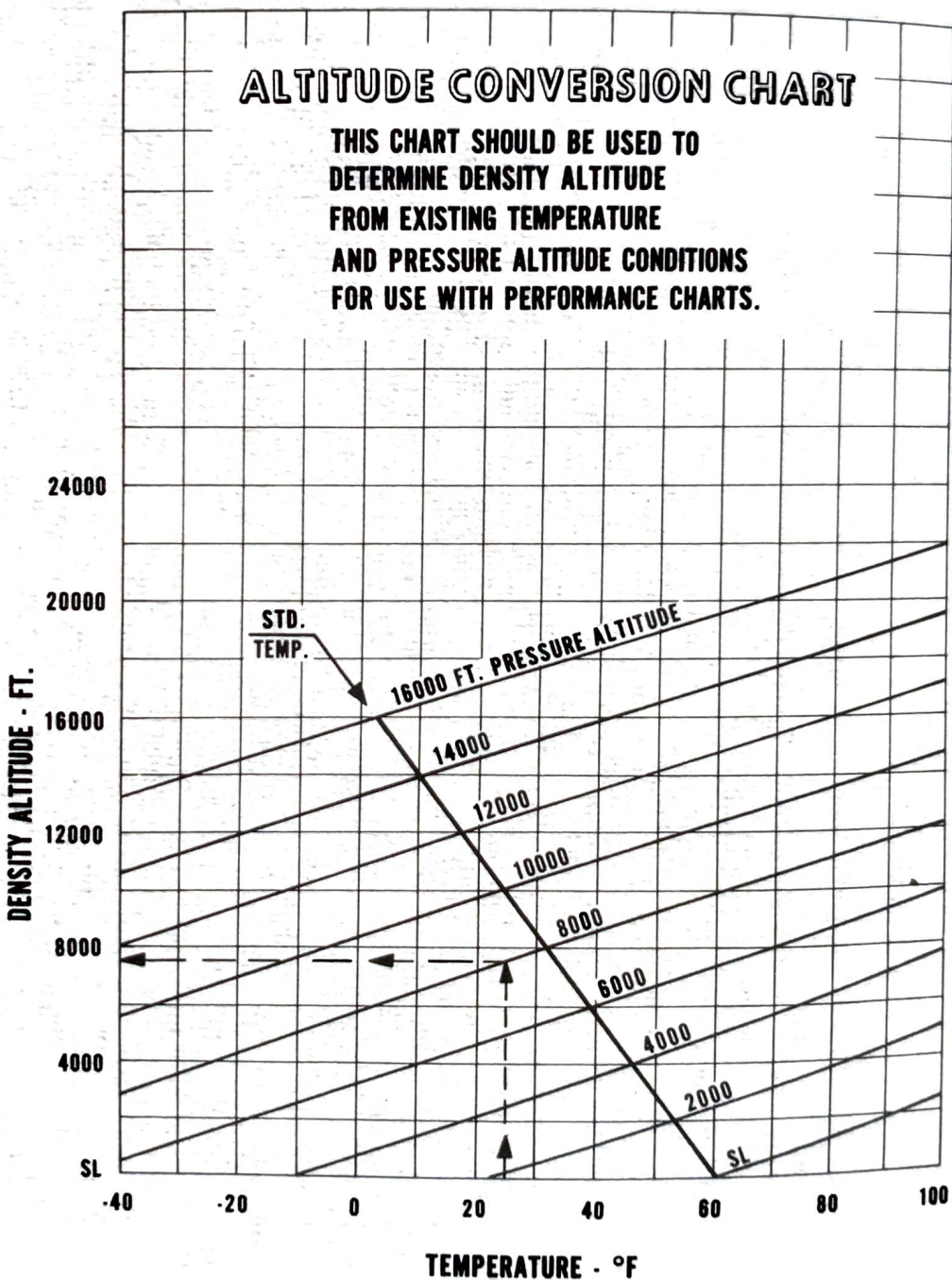

# PA-28-180 PIPER CHEROKEE

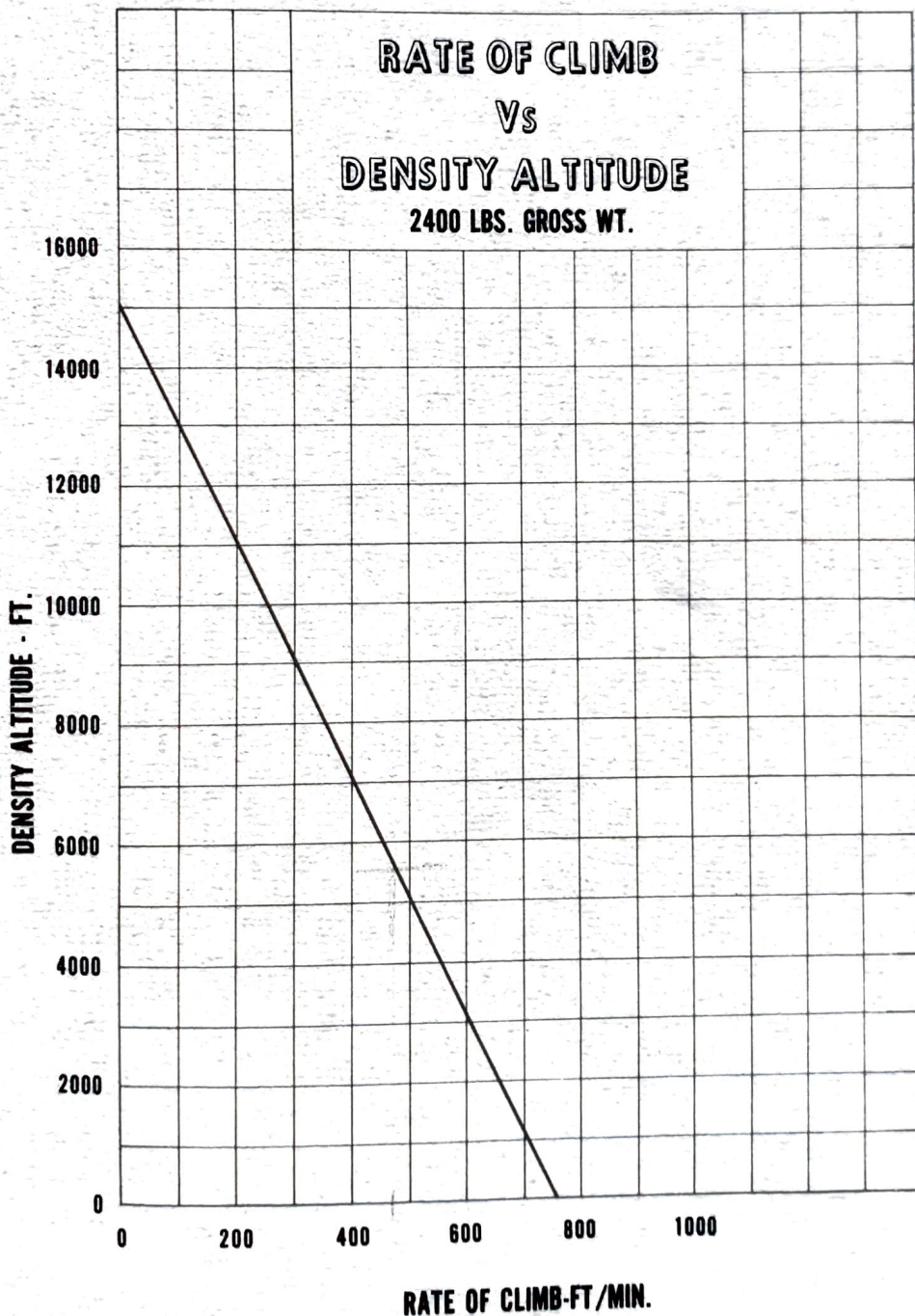

# PA-28-180 PIPER CHEROKEE

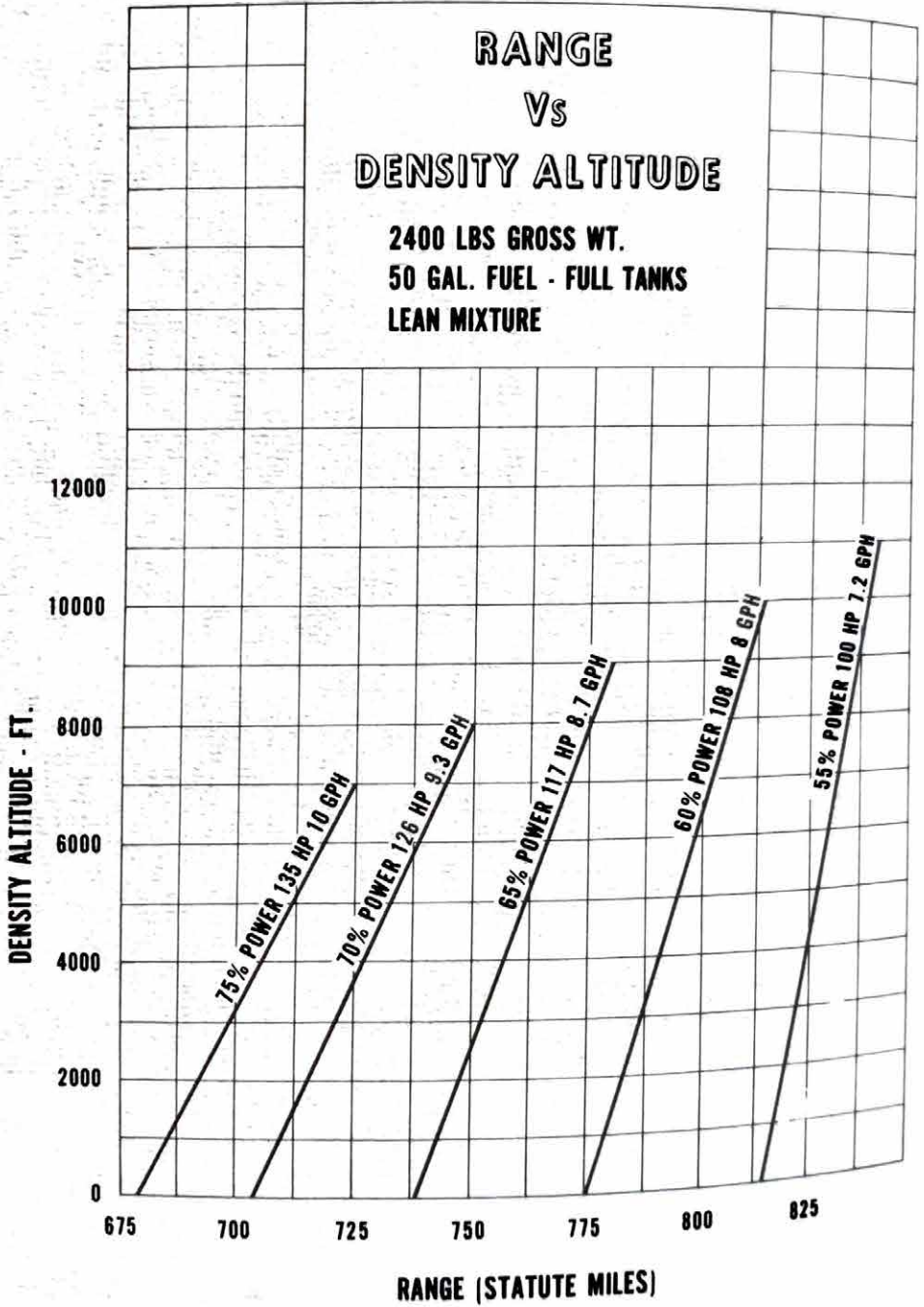



# PA-28-180 PIPER CHEROKEE

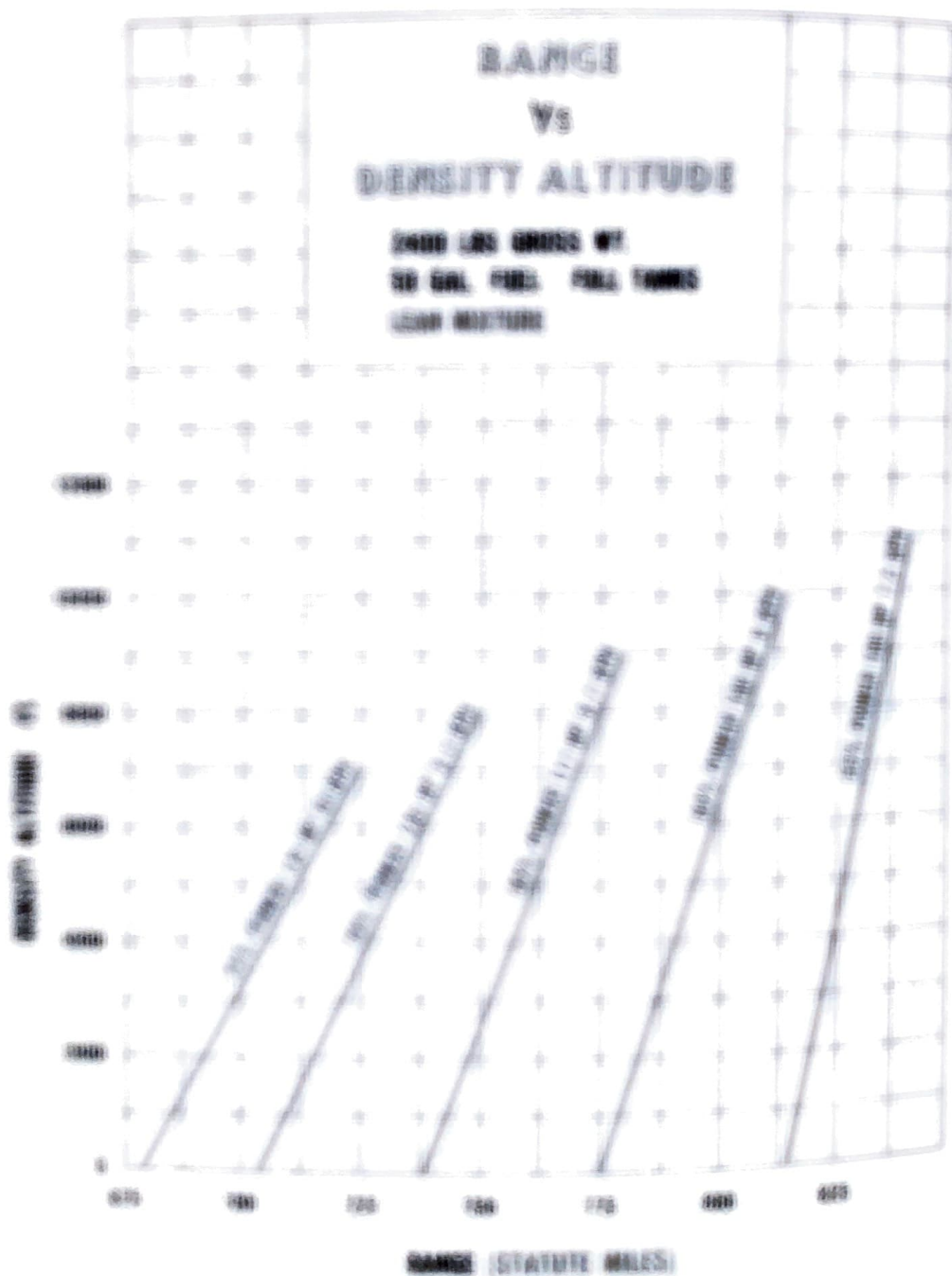



# PA-28-180 PIPER CHEROKEE

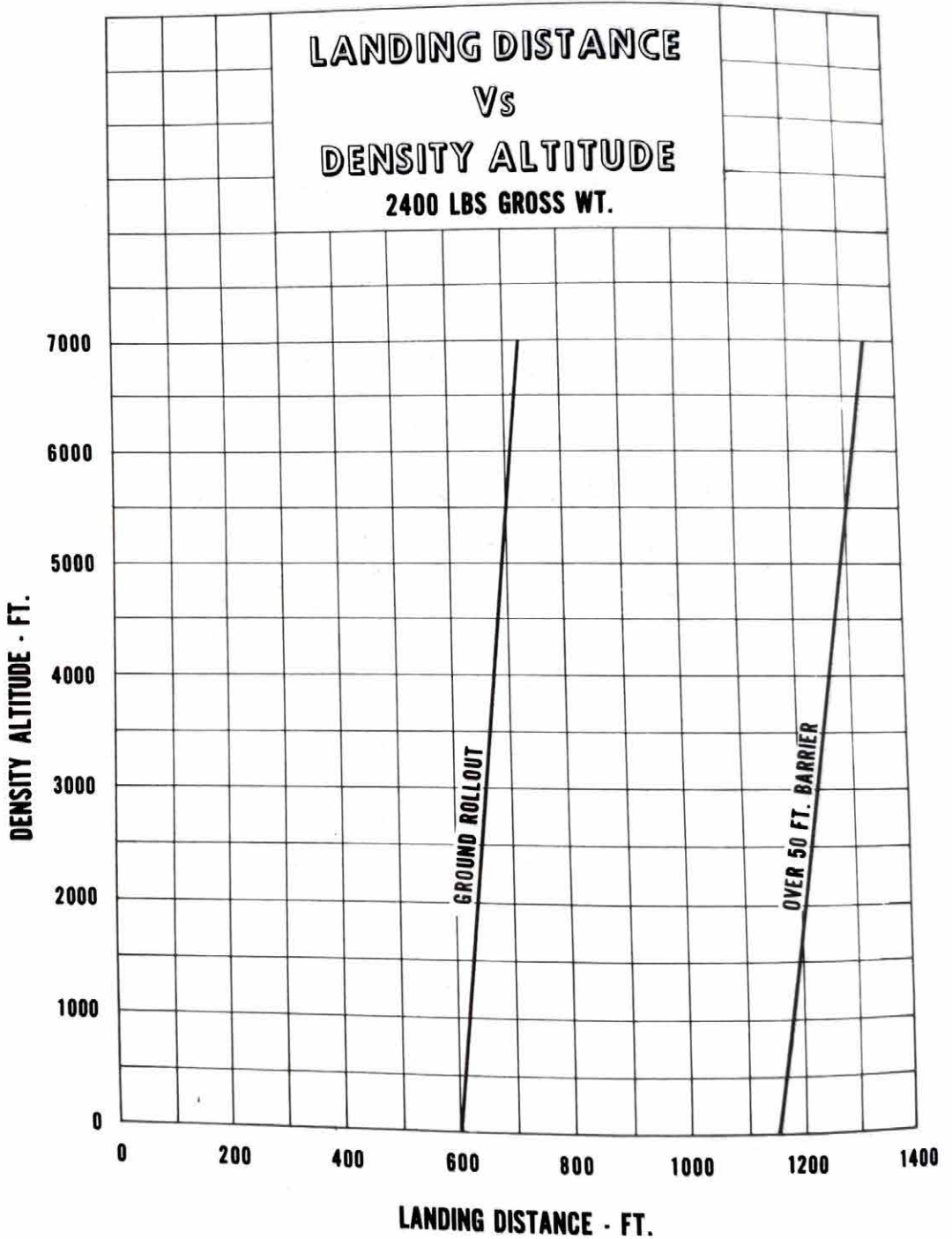

**Power Setting Table-Lycoming Model O-360 Series, 180 HP Engine**

Press. Alt	Std Alt Temp ° F	108 HP 60% Power RPM	117 HP 65% Power RPM	126 HP 70% Power RPM	135 HP 75% Power RPM	Press. Alt
SL	59	2290	2370	2440	2500	SL
1,000	55	2310	2390	2460	2520	1,000
2,000	52	2330	2410	2480	2540	2,000
3,000	48	2350	2430	2500	2560	3,000
4,000	45	2370	2450	2520	2580	4,000
5,000	41	2390	2470	2540	2600	5,000
6,000	38	2410	2490	2560	2620	6,000
7,000	34	2430	2510	2580	2640	7,000
8,000	31	2450	2530	2600	-	8,000
9,000	27	2470	2550	2620	-	9,000
10,000	23	2490	2570	-	-	10,000
11,000	19	2510	2590	-	-	11,000
12,000	16	2530	-	-	-	12,000

**SECTION V**  
**GENERAL MAINTENANCE**

Landing Gear Service . . . . .	34
Brake Service . . . . .	36
Tire Inflation . . . . .	36
Care of Windshield and Windows . . . . .	37
Battery Service . . . . .	37
Fuel and Oil Requirements . . . . .	38
Fuel System . . . . .	38
Care of Air Filter . . . . .	39
Leveling and Rigging . . . . .	39
Serial Number Plate . . . . .	40

## SECTION V

### GENERAL MAINTENANCE

This section of the Cherokee "D" Handbook contains information which pertains to minor maintenance of the airplane. For further maintenance assistance refer to the Service Manual for this airplane. Any complex repairs or modification should be accomplished by a Piper Certified Service Center or equivalent.

#### LANDING GEAR SERVICE

The main wheels are Cleveland Aircraft Products, Model #40-86, with Cleveland single disk hydraulic brake assemblies, Model #30-55. The nose wheel is a Cleveland Aircraft Products, Model #38501. All wheels use a 6.00 x 6, four ply rating, type III tire with tube.

Main wheels are easily removed by taking off the hub cap, axle nut, and the two bolts holding the brake segment in place, after which the wheel slips easily from the axle.

Tires are demounted from the wheels by deflating the tire, removing the three through-bolts, and separating the wheel halves.

Landing gear oleo struts should be checked for proper strut exposures and fluid leaks. The required extensions for the strut when under normal static load (empty weight of airplane plus full fuel and oil) is 3.25 inches for the nose gear and 4.50 inches for the main gear. Should the strut exposure be below that required, it should be determined whether air or oil is required by first raising the airplane on jacks. Depress the valve core to allow

air to escape from the strut housing chamber. Remove the filler plug and slowly raise the strut to full compression. If the strut has sufficient fluid it will be visible up to the bottom of the filler plug hole and will then only require proper inflation.

Should fluid be below the bottom of the filler plug hole, oil should be added. Replace the plug with valve core removed, attach a clear plastic hose to the valve strut of the filler plug and submerge the other end in a container of hydraulic fluid (MIL-H-5606). Fully compress and extend the strut several times thus drawing fluid from the container and expelling air from the strut chamber. To allow the fluid to enter the bottom chamber of the main gear strut housing, the torque link assembly must be disconnected to let the strut be extended a minimum of 10 inches. (The nose gear torque links need not be disconnected.) Do not allow the strut to extend more than 12 inches. When air bubbles cease to flow through the hose, compress the strut fully and again check fluid level. Reinstall the valve core and filler plug, and the main gear torque links, if disconnected.

With fluid in the strut housing at the correct level, attach a strut pump to the air valve and with the airplane on the ground, inflate the oleo strut to the correct height.

In jacking the Cherokee for landing gear or other service, a jack kit (available through Piper Dealers or Distributors) should be used. This kit consists of two hydraulic jacks and a tail stand. At least 250 pounds of ballast should be placed on the base of the tail stand before the airplane is jacked up. The hydraulic jacks should be placed under the jack points on the bottom of the wing and the airplane jacked up until the tail skid is at the right height to attach the tail stand. After attaching the tail stand and adding the ballast, the jacking may be continued until the aircraft is at the height desired.

The steering arms from the rudder pedals to the nose wheel are adjusted at the rudder pedals or at the nose wheel by turning in or out the threaded rod end bearings. Adjustment is normally accomplished at the forward end of the rods and should be done in such a way that the nose wheel is in line with the fore and aft axis of the plane when the rudder pedals and rudder are centered.

air to escape from the strut housing chamber. Remove the filler plug and slowly raise the strut to full compression. If the strut has sufficient fluid it will be visible up to the bottom of the filler plug hole and will then only require proper inflation.

Should fluid be below the bottom of the filler plug hole, oil should be added. Replace the plug with valve core removed, attach a clear plastic hose to the valve strut of the filler plug and submerge the other end in a container of hydraulic fluid (MIL-H-5606). Fully compress and extend the strut several times thus drawing fluid from the container and expelling air from the strut chamber. To allow the fluid to enter the bottom chamber of the main gear strut housing, the torque link assembly must be disconnected to let the strut be extended a minimum of 10 inches. (The nose gear torque links need not be disconnected.) Do not allow the strut to extend more than 12 inches. When air bubbles cease to flow through the hose, compress the strut fully and again check fluid level. Reinstall the valve core and filler plug, and the main gear torque links, if disconnected.

With fluid in the strut housing at the correct level, attach a strut pump to the air valve and with the airplane on the ground, inflate the oleo strut to the correct height.

In jacking the Cherokee for landing gear or other service, a jack kit (available through Piper Dealers or Distributors) should be used. This kit consists of two hydraulic jacks and a tail stand. At least 250 pounds of ballast should be placed on the base of the tail stand before the airplane is jacked up. The hydraulic jacks should be placed under the jack points on the bottom of the wing and the airplane jacked up until the tail skid is at the right height to attach the tail stand. After attaching the tail stand and adding the ballast, the jacking may be continued until the aircraft is at the height desired.

The steering arms from the rudder pedals to the nose wheel are adjusted at the rudder pedals or at the nose wheel by turning in or out the threaded rod end bearings. Adjustment is normally accomplished at the forward end of the rods and should be done in such a way that the nose wheel is in line with the fore and aft axis of the plane when the rudder pedals and rudder are centered.



Alignment of the nose wheel can be checked by pushing the airplane back and forth with the rudder centered to determine that the plane follows a perfectly straight line. The turning arc of the nose wheel is 22 degrees in either direction and factory adjusted at stops on the bottom of the forging. The turning radius of the nose wheel is 17 feet.

The steering arm stops should be carefully adjusted so that the nose wheel reaches its full travel just after the rudder hits its stops. This guarantees that the rudder will be allowed to move through its full travel.

## BRAKE SERVICE

The brake system is filled with MIL-H-5606 (Petroleum base) hydraulic brake fluid. This should be checked at every 50 hour inspection and replenished when necessary by filling the brake reservoir on the upper left front side of the firewall to the indicated level. If the system as a whole has to be refilled with fluid it should be done from the brake end of the system by filling with fluid under pressure. This will eliminate air from the system as it is being filled.

No adjustment of brake clearances is necessary on the Cherokee brakes. If after extended service the brake blocks become worn excessively, they are easily replaced with new segments.

## TIRE INFLATION

For maximum service from the tires on the Cherokee, keep the tires inflated to the proper pressure of 24 pounds for all three wheels. Interchange the tires on the main wheels if necessary to produce even wear. All wheels and tires are balanced before original installation, and the relationship of the tire, tube, and

wheel should be maintained if at all possible. Unbalanced wheels can cause extreme vibration on take-off. In the installation of new components it may be necessary to rebalance the wheel with the tire mounted.

## **CARE OF WINDSHIELD AND WINDOWS**

A certain amount of care is needed to keep the plexiglas windows clean and unmarred. The following procedure is recommended:

1. Flush with clean water and dislodge excess dirt, mud, etc. with your hand.

2. Wash with mild soap and water or Piper Plastic Cleaner. Use a soft cloth or sponge. Do not rub.

3. Remove oil, grease or sealing compounds with a soft cloth and kerosene.

4. After cleaning, apply a thin coat of hard polishing wax. Rub lightly with a soft cloth.

5. A severe scratch or mar may be removed by using jeweler's rouge to rub out the scratch, smoothing, and then applying wax.

## **BATTERY SERVICE**

Access for service or inspection of the battery is obtained through the removal of the panel at the right rear side of the baggage compartment. The stainless steel box has a plastic drain tube which is normally closed off with a clamp and which should be opened occasionally to drain off any accumulation of liquid. The battery should be checked for proper fluid level, but must not be filled above the baffle plates. Use only water - no acid. A hydrometer check should be performed to determine the percent of charge present in the battery.

If the battery is not up to charge, recharge starting at a 4 ampere rate and finishing with a 2 ampere rate. Quick charges are not recommended.

**FUEL AND OIL REQUIREMENTS**

Aviation Grade 91/96 Octane <sup>(BLUE)</sup> (minimum) fuel must be used in the Cherokee. Because the use of lower grades can cause serious damage in a very short period of time, the engine warranty is invalidated by such use.

The oil capacity of the Lycoming O-360-A4A is 8 quarts, and the minimum safe quantity is 2 quarts. It is recommended that the oil and oil filter be changed every 50 hours, or sooner under unfavorable conditions. The following grades are recommended for the specific temperatures:

Temperatures above 60° F	S.A.E. 50
Temperatures between 30° and 90° F	S.A.E. 40
Temperatures between 0° and 70° F	S.A.E. 30
Temperatures below 10° F	S.A.E. 20

**FUEL SYSTEM**

The fuel screen in the strainer will require cleaning every 50 hour inspection. The strainer, located ahead of the firewall, is accessible for cleaning by removal of the lower cowl. When the strainer is reassembled after cleaning, a small amount of grease applied to the gasket will facilitate assembly.

## CARE OF AIR FILTER

The carburetor air filter must be cleaned at least once every fifty hours. Under extremely adverse conditions of operation it may be necessary to clean the filter daily. Extra filters are inexpensive and a spare should be kept on hand and used as a rapid replacement.

The filter manufacturer recommends that the filter be tapped gently to remove dirt particles. Do not blow out with compressed air.

## LEVELING AND RIGGING

Leveling the Cherokee "D" for purposes of weighing or rigging is accomplished as follows:

1. Partially withdraw two machine screws located immediately below the left front side window. These screws are leveling points, and the airplane is longitudinally level when a level placed on the heads of these screws indicates level.

2. To put the airplane in a longitudinally level position on scales, first block the main gear oleos in the fully extended position, then deflate the nose wheel tire until the proper attitude is obtained. For rigging only, the airplane may be placed on jacks for leveling.

3. To level the airplane laterally, place a level across the baggage compartment floor along the rear bulkhead.

**Rigging:** Although the fixed flight surfaces on the Cherokee cannot be adjusted for rigging purposes, it may be necessary upon occasion to check the position of these surfaces. The movable surfaces all have adjustable stops, as well as adjustable turnbuckles on the cables or push-pull tubes, so that their range of travel can be altered. The positions and angular travels of the various surfaces are as follows:

1. Wings: 7° dihedral, 2° washout.
2. Stabilator Travel: 18° up, 2° down, tolerance  $\pm 1^\circ$ .

3. Fin should be vertical and in line with center of fuselage.
4. Aileron Travel: 30° up, 15° down, tolerance  $\pm 2^\circ$ .
5. Flap Travel: 10°, 25°, 40°, tolerance  $\pm 2^\circ$ .
6. Rudder Travel: 27° right and left, tolerance  $\pm 2^\circ$ .
7. Stabilator Tab Travel: 3° up, 12° down, tolerance  $\pm 1^\circ$ .

Cable tensions for the various controls are as follows:

Rudder: 40  $\pm 5$ #

Stabilator: 40  $\pm 5$ #

Ailerons: 40  $\pm 5$ #

Stabilator Trim: 10  $\pm 1$ #

Flaps: Approx. 10#

For extreme cases of wing heaviness, the flap on the wing heavy side may be adjusted down from the zero position as desired.

The service manual should be consulted for the proper method of adjusting surface travels.

### **SERIAL NUMBER PLATE**

The serial number plate is located near the stabilator on the left side of the airplane. Refer to this number for service or warranty matters.

3. Fin should be vertical and in line with center of fuselage.
4. Aileron Travel: 30° up, 15° down, tolerance  $\pm 2^\circ$ .
5. Flap Travel: 10°, 25°, 40°, tolerance  $\pm 2^\circ$ .
6. Rudder Travel: 27° right and left, tolerance  $\pm 2^\circ$ .
7. Stabilator Tab Travel: 3° up, 12° down, tolerance  $\pm 1^\circ$ .

Cable tensions for the various controls are as follows:

Rudder: 40  $\pm$  5#

Stabilator: 40  $\pm$  5#

Ailerons: 40  $\pm$  5#

Stabilator Trim: 10  $\pm$  1#

Flaps: Approx. 10#

For extreme cases of wing heaviness, the flap on the wing heavy side may be adjusted down from the zero position as desired.

The service manual should be consulted for the proper method of adjusting surface travels.

## **SERIAL NUMBER PLATE**

The serial number plate is located near the stabilator on the left side of the airplane. Refer to this number for service or warranty matters.

NOTES

<p>SKETCH A</p>	<p>SKETCH B</p>	<p>SKETCH C</p>	<p>SKETCH D</p>	<p>SKETCH E</p>
<p>SKETCH A</p>	<p>SKETCH B</p>	<p>SKETCH C</p>	<p>SKETCH D</p>	
<p><b>EXAMPLE</b></p> <p><b>PARTS IDENTIFICATION</b></p> <p><b>METHOD OF IDENTIFICATION</b></p>	<p><b>IDENTIFICATION LETTER</b></p> <p>A MIL-L-7870</p> <p>B MIL-L-6982</p> <p>C MIL-H-5606</p> <p>D MIL-G-2827</p> <p>E MIL-G-3545</p> <p>F DUPONT ALL PURPOSE SLIP SPRAY (6611) OR EQUIVALENT</p> <p>G PARKER "O" RING LUBRICANT</p>	<p><b>TYPE OF LUBRICANTS</b></p> <p><b>LUBRICANT SPECIFICATION</b></p> <p><b>LUBRICATING OIL, GENERAL PURPOSE:</b></p> <p>LUBRICATING OIL, AIRCRAFT RECIPRO-CATING ENGINE (FISSTON) GRADE AS LOW TEMPERATURE</p> <p><b>GREASE, AIRCRAFT AND INSTRUMENT, GEAR AND ACTUATOR SCREW</b></p> <p>HYDRAULIC FLUID, PETROLEUM BASE</p> <p><b>FREQUENCY</b></p> <p>MAINT □</p> <p>50 ○</p> <p>100 ◇</p> <p>500 ⬡</p> <p>AS ▲</p>	<p><b>SPECIAL INSTRUCTIONS:</b></p> <ol style="list-style-type: none"> <li>AIR FILTER - TO CLEAN FILTER, TAP GENTLY TO REMOVE DIRT PARTICLES. DO NOT BEAT OR PUNCTURE OR DAMAGED. USE OIL, RING BUSHINGS - CLEAN EXTERIOR WITH A DRY TYPE BEHAVIOR BEFORE LUBRICATING.</li> <li>WHEEL BEARINGS - DISASSEMBLE AND CLEAN WITH A DRY TYPE SOLVENT. ASCERTAIN THAT GREASE IS PACKED BETWEEN THE BEARING ROLLER AND CONE. DO NOT PACK GREASE IN WHEEL HOUSING.</li> <li>RETAINERS AND BRAKE RESERVOIR - FILL PER INSTRUCTIONS ON UNIT OR CONTAINER. REFER TO SERVICE MANUAL, SECTION II.</li> <li>"O" RING CONTROL SHAFT BUSHING - DISASSEMBLY "O" RING AND REASSEMBLY. WIPE ALL LUBRICATION POINTS CLEAN.</li> <li>LUBRICATING OIL, DIRT, ETC. BEFORE LUBRICATING. INTERVALLS BETWEEN OIL CHANGES CAN BE INCREASED AS MUCH AS 100% ON ENGINES EQUIPPED WITH FULL FLOW CARTRIDGE TYPE OIL FILTERS - PROVIDED THE ELEMENT IS REPLACED EACH 50 HOURS OF OPERATION.</li> </ol> <p><b>CAUTIONS</b></p> <ol style="list-style-type: none"> <li>DO NOT USE HYDRAULIC FLUID WITH A CASTOR OIL OR ESTER BASE.</li> <li>DO NOT OVER LUBRICATE COCKPIT CONTROLS.</li> <li>DO NOT APPLY LUBRICANT TO RUBBER PARTS.</li> </ol>	
<p><b>LUBRICATION CHART PA-28-180 'D'</b></p>	<p><b>NOTES</b></p> <ol style="list-style-type: none"> <li>PILOT AND PASSENGER SEATS - LUBRICATE TRACK ROLLERS AND STOP PINS AS REQUIRED. CLEANING AND REPACKING AFTER WHEEL BEARINGS NECESSARY.</li> <li>EXPOSED SELECTION VALVE - LUBRICATE FUEL SELECTOR VALVE AS REQUIRED. REFER TO PAPER SERVICE LETTER FOR USE OF DETERGENT OIL.</li> </ol>			



# INDEX

## SECTION I

	Page
Specifications: . . . . .	1
Performance . . . . .	1
Weights . . . . .	2
Power Plant . . . . .	2
Fuel and Oil . . . . .	2
Baggage . . . . .	3
Dimensions . . . . .	3
Landing Gear . . . . .	3

## SECTION II

Design Information: . . . . .	5
Engine and Propeller . . . . .	5
Structures . . . . .	6
Landing Gear . . . . .	7
Control Systems . . . . .	7
Fuel System . . . . .	9
Electrical System. . . . .	13
Heating and Ventilating System . . . . .	13
Cabin Features . . . . .	13

## SECTION III

Operating Instructions: . . . . .	16
Preflight . . . . .	17
Starting Engine . . . . .	19
Warm-Up and Ground Check . . . . .	19
Take-Off . . . . .	20
Climb . . . . .	20
Stalls . . . . .	21
Cruising . . . . .	22
Approach and Landing . . . . .	23
Stopping Engine . . . . .	23

## INDEX (cont)

### SECTION III (cont)

	Page
Engine Power Loss . . . . .	23
Moorng . . . . .	24
Weight and Balance . . . . .	24
Operating Tips . . . . .	24

### SECTION IV

Performance Charts: . . . . .	27
Take-off Distance vs Density Altitude . . . . .	27
Altitude Conversion Chart . . . . .	28
Rate of Climb vs Density Altitude . . . . .	29
Range vs Density Altitude . . . . .	30
True Airspeed and RPM vs Density Altitude . . . . .	31
Landing Distance vs Density Altitude . . . . .	32
Power Setting Table . . . . .	33

### SECTION V

General Maintenance: . . . . .	34
Landing Gear Service . . . . .	34
Brake Service . . . . .	36
Tire Inflation . . . . .	36
Care of Windshield and Windows . . . . .	37
Battery Service . . . . .	37
Fuel and Oil Requirements. . . . .	38
Fuel System . . . . .	38
Care of Air Filter . . . . .	39
Leveling and Rigging . . . . .	39
Serial Number Plate . . . . .	40