

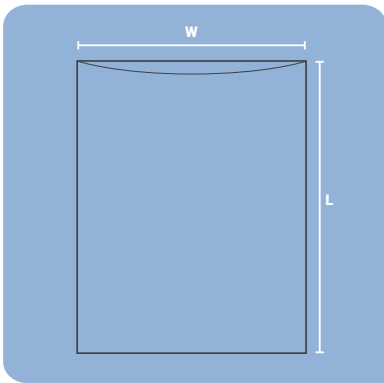

LAYFLAT POLY BAGS



THE BASICS

Our Layflat Poly Bags are designed for a wide range of uses and exhibit extreme durability. Produced with our state-of-the-art manufacturing equipment, they offer superior bottom seal and side weld constructions.

ENHANCED CLARITY & STRENGTH

Built utilizing high grade polyethylene resin and advanced blending techniques, these bags exhibit enhanced clarity and tensile strength.

CHOOSE FROM 7 THICKNESSES

- Light weight – 1, 1.25, 1.5 mil
- Medium weight – 2 mil
- Heavy weight – 3 mil
- Extra-heavy weight – 4 mil
- Super-heavy weight – 6 mil

TECHNICAL DETAILS

Made from a performance blend of Low-Density Polyethylene that meets FDA/USDA specifications. These are heat sealable and feature a bottom seal or side weld construction.

1 MIL LAYFLAT

ITEM	W x L	CNT	WT
2200	3 X 3	1000	1
2202	3 X 4	1000	2
2205	3 X 5	1000	2
2204	3 X 6	1000	2
2206	3 X 8	1000	2
2207	3 X 10	1000	3
2208	3 X 12	1000	3
2209	3 X 16	1000	4
2210	4 X 4	1000	2
2211	4 X 5	1000	2
2215	4 X 6	1000	2
2216	4 X 7	1000	2
2220	4 X 8	1000	3
2225	4 X 10	1000	3
2222	4 X 12	1000	4
2224	4 X 16	1000	5
2229	5 X 6	1000	2
2230	5 X 7	1000	3
2235	5 X 8	1000	3
2240	5 X 10	1000	4
2245	5 X 12	1000	5
2246	5 X 16	1000	6
2250	6 X 6	1000	3
2255	6 X 8	1000	4
2260	6 X 9	1000	4
2265	6 X 10	1000	4
2270	6 X 12	1000	5
2256	6 X 14	1000	6
2259	6 X 20	1000	8
2272	7 X 7	1000	4
2273	7 X 8	1000	5
2274	7 X 9	1000	5
2275	7 X 10	1000	5
2276	7 X 12	1000	6
2277	7 X 14	1000	7
2278	7 X 16	1000	8
2279	7 X 18	1000	8
2280	8 X 8	1000	5
2285	8 X 10	1000	6
2290	8 X 12	1000	7
2295	8 X 14	1000	8
2300	8 X 16	1000	9
2301	8 X 18	1000	9
2302	8 X 20	1000	10

1 MIL LAYFLAT

ITEM	W x L	CNT	WT
2303	8 X 24	1000	12
2308	9 X 10	1000	7
2305	9 X 12	1000	8
2310	9 X 14	1000	8
2315	9 X 16	1000	9
2320	9 X 18	1000	11
2325	10 X 10	1000	7
2330	10 X 12	1000	8
2335	10 X 14	1000	9
2340	10 X 16	1000	11
2345	10 X 18	1000	12
2346	10 X 20	1000	13
2347	10 X 24	1000	15
2351	11 X 12	1000	9
2352	11 X 14	1000	10
2353	11 X 16	1000	12
2354	11 X 18	1000	13
2350	12 X 12	1000	10
2355	12 X 14	1000	11
2358	12 X 15	1000	12
2360	12 X 16	1000	12
2365	12 X 18	1000	14
2370	12 X 20	1000	15
2371	12 X 24	1000	18
2373	12 X 36	1000	27
2378	13 X 14	1000	12
2379	13 X 16	1000	14
2381	13 X 20	1000	17
2375	14 X 14	1000	12
2380	14 X 16	1000	15
2385	14 X 18	1000	16
2390	14 X 20	1000	18
2391	14 X 24	1000	21
2392	14 X 30	1000	26
2396	15 X 15	1000	15
2397	15 X 18	1000	17
2398	15 X 24	1000	23
2395	16 X 16	1000	16
2400	16 X 18	1000	20
2405	16 X 20	1000	22
2406	16 X 24	1000	26
2407	16 X 30	1000	33
2409	16 X 40	1000	43
2410	18 X 18	1000	22

1 MIL LAYFLAT

ITEM	W x L	CNT	WT
2415	18 X 24	1000	27
2416	18 X 30	1000	33
2420	20 X 20	1000	25
2425	20 X 24	1000	30
2426	20 X 30	1000	37
2427	20 X 36	500	22
2428	20 X 42	500	26
2430	24 X 24	1000	36
2435	24 X 30	500	22
2440	24 X 36	500	27
2443	26 X 26	1000	42
2444	26 X 30	500	24
2446	26 X 36	500	29
2449	28 X 36	500	31
2445	30 X 30	500	28
2450	30 X 36	500	34
2452	30 X 42	500	39
2455*	36 X 36	500	40
2460*	40 X 46	250	29
2470*	44 X 48	250	33
2475*	48 X 48	250	36

1.25 MIL LAYFLAT

ITEM	W x L	CNT	WT
2754	4 X 5	1000	2
2778	6 X 9	1000	5
2782	6 X 12	1000	6
2798	8 X 10	1000	7
2818	9 X 12	1000	9
2830	10 X 14	1000	11
2854	12 X 14	1000	14
2856	12 X 16	1000	16
2858	12 X 18	1000	17
2878	14 X 18	1000	21
2902	16 X 20	1000	27
2912	18 X 20	1000	31
2914	18 X 24	1000	34
2936	24 X 30	500	27
2938	24 X 36	500	33
2982*	40 X 60	250	45

* ENGINEERED AND MANUFACTURED IN THE U.S.A.

LAYFLAT POLY BAGS

1.5 MIL LAYFLAT

ITEM	W x L	CNT	WT
5	2 X 3	1000	1
10	2 X 4	1000	2
11	2 X 6	1000	2
12	2 X 8	1000	3
16	2 X 10	1000	3
20	3 X 3	1000	2
25	3 X 4	1000	2
30	3 X 5	1000	2
35	3 X 6	1000	2
40	3 X 8	1000	3
41	3 X 10	1000	3
42	3 X 12	1000	4
44	3 X 24	1000	7
45	4 X 4	1000	2
50	4 X 5	1000	3
55	4 X 6	1000	3
56	4 X 7	1000	3
60	4 X 8	1000	4
65	4 X 10	1000	4
70	4 X 12	1000	5
63	4 X 14	1000	6
71	4 X 16	1000	6
72	4 X 20	1000	8
69	5 X 5	1000	3
74	5 X 6	1000	3
75	5 X 7	1000	4
80	5 X 8	1000	4
77	5 X 9	1000	5
85	5 X 10	1000	5
90	5 X 12	1000	6
94	5 X 30	1000	14
95	6 X 6	1000	4
99	6 X 7	1000	5
100	6 X 8	1000	5
105	6 X 9	1000	6
110	6 X 10	1000	6
115	6 X 12	1000	7
106	6 X 14	1000	8
116	6 X 16	1000	9
107	6 X 18	1000	11
111	7 X 7	1000	6
112	7 X 8	1000	6
113	7 X 9	1000	6
120	7 X 10	1000	7
114	7 X 12	1000	8
123	7 X 18	1000	12
125	8 X 8	1000	7
130	8 X 10	1000	8
135	8 X 12	1000	10
137	8 X 14	1000	11
140	8 X 16	1000	13
131	8 X 18	1000	15
141	8 X 20	1000	16
142	8 X 24	1000	20
132	8 X 28	1000	23
143	8 X 30	1000	24
133	8 X 36	1000	26
134	8 X 40	1000	32
145	9 X 12	1000	10
150	9 X 14	1000	13

1.5 MIL LAYFLAT

ITEM	W x L	CNT	WT
152	9 X 15	1000	14
155	9 X 16	1000	15
161	9 X 24	1000	22
165	10 X 10	1000	10
170	10 X 12	1000	12
175	10 X 14	1000	14
177	10 X 15	1000	15
180	10 X 16	1000	16
185	10 X 18	1000	18
186	10 X 20	1000	20
187	10 X 24	1000	24
182	10 X 28	1000	26
188	10 X 30	1000	28
189	10 X 36	1000	33
192	11 X 14	1000	16
193	11 X 16	1000	18
190	12 X 12	1000	15
195	12 X 14	1000	17
199	12 X 15	1000	18
200	12 X 16	1000	20
205	12 X 18	1000	22
210	12 X 20	1000	24
215	12 X 24	1000	29
217	12 X 30	1000	33
218	12 X 36	1000	40
223	13 X 16	1000	21
224	13 X 20	1000	27
219	14 X 14	1000	20
220	14 X 16	1000	23
225	14 X 18	1000	23
230	14 X 20	1000	26
231	14 X 24	1000	34
233	14 X 36	1000	46
236	15 X 15	1000	23
237	15 X 18	1000	25
238	15 X 20	1000	28
239	15 X 24	1000	37
234	16 X 16	1000	23
235	16 X 18	1000	27
240	16 X 20	1000	30
245	16 X 24	1000	39
247	16 X 30	1000	44
248	16 X 36	500	27
249	16 X 40	500	29
250	18 X 18	1000	30
252	18 X 20	1000	37
255	18 X 24	1000	40
260	18 X 30	500	25
261	18 X 36	500	30
262	18 X 42	500	38
263	18 X 48	500	40
265	20 X 20	1000	36
270	20 X 24	500	22
275	20 X 30	500	27
276	20 X 36	500	32
271	22 X 24	500	24
273	22 X 30	500	30
274	22 X 36	500	35
280*	24 X 24	500	26
281*	24 X 26	500	28

1.5 MIL LAYFLAT

ITEM	W x L	CNT	WT
285*	24 X 30	500	32
290*	24 X 36	500	39
293*	24 X 60	250	32
287*	26 X 30	500	35
288*	26 X 36	500	42
289*	26 X 42	250	25
307*	28 X 40	250	25
295*	30 X 30	500	40
300*	30 X 36	250	24
301*	30 X 42	250	28
302*	30 X 48	250	32
311*	32 X 32	500	46
312*	32 X 40	250	29
321*	34 X 40	250	31
305*	36 X 36	250	29
310*	36 X 42	250	34
315*	36 X 48	250	39
329*	38 X 60	200	41
319*	40 X 42	250	38
320*	40 X 48	200	34
322*	40 X 54	200	39
325*	40 X 60	200	43
330*	48 X 48	200	41
335*	48 X 60	100	26
337*	52 X 60	100	28
339*	56 X 60	100	30

2 MIL LAYFLAT

ITEM	W x L	CNT	WT
340	2 X 3	1000	1
345	2 X 4	1000	2
346	2 X 6	1000	2
347	2 X 8	1000	3
351	2 X 10	1000	3
352	2 X 12	1000	4
348	2 X 16	1000	4
354	2 X 24	1000	7
355	3 X 3	1000	1
360	3 X 4	1000	2
365	3 X 5	1000	2
370	3 X 6	1000	3
375	3 X 8	1000	3
376	3 X 10	1000	4
377	3 X 12	1000	5
372	3 X 14	1000	6
373	3 X 16	1000	7
378	3 X 18	1000	8
379	3 X 24	1000	9
380	4 X 4	1000	3
385	4 X 5	1000	3
390	4 X 6	1000	4
391	4 X 7	1000	4
395	4 X 8	1000	4
400	4 X 10	1000	6
405	4 X 12	1000	7
402	4 X 14	1000	7
406	4 X 16	1000	8
404	4 X 18	1000	9
407	4 X 20	1000	10

2 MIL LAYFLAT

ITEM	W x L	CNT	WT
408	4 X 24	1000	12
409	5 X 5	1000	4
411	5 X 6	1000	5
410	5 X 7	1000	5
415	5 X 8	1000	6
412	5 X 9	1000	6
420	5 X 10	1000	7
425	5 X 12	1000	8
413	5 X 14	1000	9
414	5 X 16	1000	10
417	5 X 20	1000	12
418	5 X 24	1000	15
419	5 X 28	1000	18
429	5 X 30	1000	18
430	6 X 6	1000	5
431	6 X 7	1000	6
435	6 X 8	1000	7
440	6 X 9	1000	8
445	6 X 10	1000	8
450	6 X 12	1000	10
446	6 X 14	1000	11
451	6 X 16	1000	12
447	6 X 18	1000	14
452	6 X 20	1000	16
453	6 X 24	1000	18
448	6 X 28	1000	21
454	6 X 30	1000	22
449	7 X 7	1000	7
456	7 X 8	1000	8
458	7 X 9	1000	8
455	7 X 10	1000	9
459	7 X 12	1000	12
457	7 X 14	1000	13
461	7 X 16	1000	15
462	7 X 18	1000	17
463	7 X 20	1000	19
464	7 X 24	1000	23
467	7 X 30	1000	26
460	8 X 8	1000	9
465	8 X 10	1000	10
470	8 X 12	1000	12
472	8 X 14	1000	14
475	8 X 16	1000	15
468	8 X 18	1000	17
476	8 X 20	1000	20
477	8 X 24	1000	24
471	8 X 36	1000	35
473	8 X 40	1000	38
479	9 X 10	1000	11
480	9 X 12	1000	13
485	9 X 14	1000	15
486	9 X 15	1000	17
490	9 X 16	1000	18
495	9 X 18	1000	20
496	9 X 20	1000	22
497	9 X 24	1000	26
500*	10 X 10	1000	12
505*	10 X 12	1000	15
506*	10 X 13	1000	15
510*	10 X 14	1000	17

2 MIL LAYFLAT

ITEM	W x L	CNT	WT
511*	10 X 15	1000	18
515*	10 X 16	1000	20
520*	10 X 18	1000	22
521*	10 X 20	1000	24
522*	10 X 24	1000	29
524*	10 X 36	1000	43
527*	11 X 14	1000	19
528*	11 X 16	1000	21
529*	11 X 18	1000	24
525*	12 X 12	1000	18
530*	12 X 14	1000	21
534*	12 X 15	1000	22
535*	12 X 16	1000	23
540*	12 X 18	1000	26
545*	12 X 20	1000	29
550*	12 X 24	1000	35
552*	12 X 30	1000	43
553*	12 X 36	500	26
536*	13 X 13	1000	20
538*	13 X 16	1000	25
539*	13 X 20	1000	31
541*	13 X 24	1000	38
554*	14 X 14	1000	24
555*	14 X 16	1000	27
560*	14 X 18	1000	31
565*	14 X 20	1000	34
566*	14 X 24	1000	40
567*	14 X 30	500	26
568*	14 X 36	500	30
564*	14 X 40	500	34
571*	15 X 15	1000	27
572*	15 X 18	1000	33
573*	15 X 20	1000	36
576*	15 X 30	500	27
569*	16 X 16	1000	31
570*	16 X 18	1000	35
575*	16 X 20	1000	39
580*	16 X 24	1000	46
578*	16 X 28	500	27
582*	16 X 30	500	29
583*	16 X 36	500	35
585*	18 X 18	1000	39
586*	18 X 20	1000	43
590*	18 X 24	500	26
595*	18 X 30	500	33
596*	18 X 36	500	39
597*	18 X 42	500	45
598*	18 X 48	250	26
600*	20 X 20	500	24
605*	20 X 24	500	29
610*	20 X 30	500	36
611*	20 X 36	500	43
612*	20 X 42	250	26
613*	20 X 48	250	29
606*	22 X 24	500	32
607*	22 X 30	500	40
615*	24 X 24	500	35
616*	24 X 26	500	38
620*	24 X 30	500	43
625*	24 X 36	250	26

LAYFLAT POLY BAGS

2 MIL LAYFLAT

ITEM	W x L	CNT	WT
626*	24 X 42	250	31
627*	24 X 48	250	35
628*	24 X 60	250	43
621*	26 X 26	500	41
623*	26 X 36	250	28
624*	26 X 42	250	33
629*	26 X 48	250	38
631*	28 X 28	500	47
632*	28 X 32	250	27
633*	28 X 36	250	31
634*	28 X 40	250	34
639*	28 X 48	250	40
641*	28 X 60	200	40
630*	30 X 30	250	27
635*	30 X 36	250	33
636*	30 X 42	250	38
637*	30 X 48	250	43
638*	30 X 60	200	43
642*	32 X 32	250	31
643*	32 X 40	250	39
646*	32 X 48	200	37
647*	32 X 56	200	43
648*	34 X 36	250	37
649*	34 X 40	250	41
651*	34 X 48	200	39
640*	36 X 36	250	39
645*	36 X 42	200	37
650*	36 X 48	200	42
652*	36 X 60	100	26
656*	38 X 42	200	39
3147*	38 X 60	100	28
3148*	38 X 65	100	30
654*	40 X 42	200	40
655*	40 X 48	100	23
657*	40 X 54	100	26
660*	40 X 60	100	29
661*	44 X 48	100	26
663*	44 X 60	100	32
665*	48 X 48	100	28
667*	48 X 54	100	31
670*	48 X 60	100	35
674*	56 X 60	100	40

3 MIL LAYFLAT

ITEM	W x L	CNT	WT
675	2 X 3	1000	2
680	2 X 4	1000	2
681	2 X 6	1000	3
682	2 X 8	1000	4
690	3 X 3	1000	2
695	3 X 4	1000	3
700	3 X 5	1000	4
705	3 X 6	1000	4
710	3 X 8	1000	5
711	3 X 10	1000	6
712	3 X 12	1000	7
715	4 X 4	1000	4
720	4 X 5	1000	4
725	4 X 6	1000	5
727	4 X 7	1000	6
730	4 X 8	1000	6
735	4 X 10	1000	8

3 MIL LAYFLAT

ITEM	W x L	CNT	WT
740	4 X 12	1000	9
736	4 X 14	1000	11
741	4 X 16	1000	13
746	5 X 5	1000	6
747	5 X 6	1000	6
745	5 X 7	1000	7
750	5 X 8	1000	8
748	5 X 9	1000	9
755	5 X 10	1000	10
760	5 X 12	1000	11
765	6 X 6	1000	7
766	6 X 7	1000	8
770	6 X 8	1000	9
775	6 X 9	1000	11
780	6 X 10	1000	12
785	6 X 12	1000	15
782	6 X 14	1000	17
786	6 X 16	1000	20
783	6 X 18	1000	22
788	6 X 24	1000	27
793	7 X 8	1000	11
794	7 X 9	1000	13
790	7 X 10	1000	14
796	7 X 12	1000	17
797	7 X 16	1000	23
795	8 X 8	1000	13
800	8 X 10	1000	15
805*	8 X 12	1000	17
807*	8 X 14	1000	20
810*	8 X 16	1000	23
811*	8 X 20	1000	29
814*	9 X 10	1000	16
815*	9 X 12	1000	20
820*	9 X 14	1000	23
825*	9 X 16	1000	26
835*	10 X 10	1000	18
840*	10 X 12	1000	22
845*	10 X 14	1000	25
846*	10 X 15	1000	27
850*	10 X 16	1000	29
855*	10 X 18	1000	32
856*	10 X 20	1000	36
857*	10 X 24	1000	43
859*	10 X 36	500	32
860*	12 X 12	1000	26
865*	12 X 14	1000	30
866*	12 X 15	1000	32
870*	12 X 16	1000	34
875*	12 X 18	1000	39
880*	12 X 20	1000	43
885*	12 X 24	500	26
888*	12 X 36	500	39
889*	14 X 14	1000	35
890*	14 X 16	1000	40
895*	14 X 18	1000	45
900*	14 X 20	500	25
901*	14 X 24	500	30
908*	15 X 20	500	27
909*	15 X 24	500	32
912*	15 X 36	250	24
904*	16 X 16	1000	46
905*	16 X 18	500	26
910*	16 X 20	500	29
915*	16 X 24	500	34

3 MIL LAYFLAT

ITEM	W x L	CNT	WT
916*	16 X 28	500	40
917*	16 X 30	500	43
922*	18 X 20	500	32
925*	18 X 24	500	39
930*	18 X 30	250	24
931*	18 X 36	250	29
935*	20 X 20	500	36
940*	20 X 24	250	22
945*	20 X 30	250	27
946*	20 X 36	250	32
947*	20 X 42	250	38
924*	22 X 30	250	30
926*	22 X 36	250	35
950*	24 X 24	250	26
951*	24 X 26	250	28
955*	24 X 30	250	32
960*	24 X 36	250	39
961*	24 X 42	250	45
962*	24 X 48	200	41
953*	26 X 26	250	30
954*	26 X 30	250	35
956*	26 X 36	250	42
964*	28 X 32	250	40
966*	28 X 36	200	36
967*	28 X 40	100	20
965*	30 X 30	250	40
970*	30 X 36	200	39
971*	30 X 42	100	23
972*	30 X 48	100	26
977*	32 X 40	100	23
983*	34 X 40	100	25
975*	36 X 36	100	23
980*	36 X 42	100	27
985*	36 X 48	100	31
986*	36 X 60	100	39
988*	38 X 42	100	29
3150*	38 X 60	100	41
3151*	38 X 64	100	44
3152*	38 X 65	100	44
990*	40 X 48	100	35
992*	40 X 54	100	39
997*	44 X 60	50	24
1000*	48 X 48	100	41
1002*	48 X 54	100	47
1005*	48 X 60	50	26
1007*	52 X 60	50	28

4 MIL LAYFLAT

ITEM	W x L	CNT	WT
1010	2 X 3	1000	3
1015	2 X 4	1000	3
1017	2 X 6	1000	4
1019	2 X 8	1000	5
1021	2 X 10	1000	6
1025	3 X 3	1000	3
1030	3 X 4	1000	4
1035	3 X 5	1000	5
1040	3 X 6	1000	5
1045	3 X 8	1000	6
1046	3 X 10	1000	8
1047	3 X 12	1000	9
1048	3 X 18	1000	14
1050	4 X 4	1000	5
1055	4 X 5	1000	6

4 MIL LAYFLAT

ITEM	W x L	CNT	WT
1060	4 X 6	1000	7
1062	4 X 7	1000	8
1065	4 X 8	1000	9
1070	4 X 10	1000	11
1075	4 X 12	1000	12
1074	4 X 18	1000	18
1077	4 X 20	1000	20
1078	4 X 24	1000	24
1079	5 X 5	1000	7
1081	5 X 6	1000	8
1080	5 X 7	1000	9
1085	5 X 8	1000	10
1090	5 X 10	1000	13
1095	5 X 12	1000	15
1083	5 X 14	1000	18
1092	5 X 18	1000	22
1096	5 X 28	1000	34
1100	6 X 6	1000	10
1101	6 X 7	1000	11
1105	6 X 8	1000	12
1110	6 X 9	1000	13
1115	6 X 10	1000	15
1120*	6 X 12	1000	18
1102*	6 X 14	1000	21
1121*	6 X 16	1000	23
1123*	6 X 24	1000	35
1124*	6 X 30	1000	43
1106	7 X 7	1000	13
1107	7 X 8	1000	14
1108*	7 X 9	1000	15
1125*	7 X 10	1000	17
1126*	7 X 12	1000	21
1127*	7 X 14	1000	24
1130	8 X 8	1000	16
1135*	8 X 10	1000	20
1140*	8 X 12	1000	23
1142*	8 X 14	1000	27
1145*	8 X 16	1000	31
1136*	8 X 18	1000	35
1147*	8 X 24	1000	46
1137*	8 X 28	500	27
1150*	9 X 12	1000	26
1160*	9 X 16	1000	35
1165*	9 X 18	1000	39
1170*	10 X 10	1000	24
1175*	10 X 12	1000	29
1180*	10 X 14	1000	34
1181*	10 X 15	1000	36
1185*	10 X 16	1000	38
1190*	10 X 18	1000	43
1191*	10 X 20	1000	48
1192*	10 X 24	500	29
1193*	10 X 30	500	36
1186*	11 X 16	1000	42
1187*	11 X 18	500	24
1195*	12 X 12	1000	35
1200*	12 X 14	1000	40
1201*	12 X 15	1000	43
1205*	12 X 16	500	23
1210*	12 X 18	500	26
1215*	12 X 20	500	29
1220*	12 X 24	500	35
1222*	12 X 30	500	43
1223*	12 X 36	250	26

4 MIL LAYFLAT

ITEM	W x L	CNT	WT
1224*	14 X 14	1000	47
1225*	14 X 16	500	27
1230*	14 X 18	500	31
1235*	14 X 20	500	34
1236*	14 X 24	500	42
1237*	14 X 30	250	25
1238*	14 X 36	250	31
1242*	15 X 15	500	27
1243*	15 X 18	500	33
1246*	15 X 24	500	43
1247*	15 X 30	250	27
1239*	16 X 16	500	31
1240*	16 X 18	500	35
1245*	16 X 20	500	39
1250*	16 X 24	500	46
1249*	16 X 28	250	27
1251*	16 X 30	250	29
1252*	16 X 36	250	35
1255*	18 X 18	500	39
1257*	18 X 20	500	43
1260*	18 X 24	250	26
1265*	18 X 30	200	26
1266*	18 X 36	200	31
1270*	20 X 20	250	24
1275*	20 X 24	250	29

ISO 9001 QUALITY

We are ISO 9001 Quality Registered. This means every bag we make must pass multiple quality inspections before it's shipped to you. The lot number on every case allows us to track and document the purity of the raw material and its exact specifications.

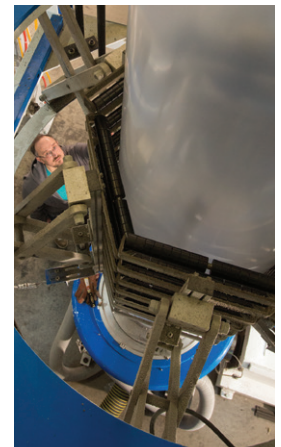

*ENGINEERED AND MANUFACTURED IN THE U.S.A.

POLY BAGS

LAYFLAT POLY BAGS

4 MIL LAYFLAT CASES

ITEM	W x L	CNT	WT
1280*	20 X 30	250	36
1281*	20 X 36	250	43
1282*	20 X 42	200	41
1283*	20 X 48	200	46
1261*	22 X 24	250	32
1262*	22 X 30	250	40
1285*	24 X 24	250	35
1290*	24 X 30	250	43
1295*	24 X 36	200	42
1296*	24 X 42	200	48
1297*	24 X 48	100	28
1298*	24 X 60	100	35
1287*	26 X 26	250	41
1288*	26 X 30	200	37
1289*	26 X 36	200	45
1291*	26 X 42	100	27
1294*	28 X 32	200	43
1299*	28 X 36	100	25
1301*	28 X 40	100	27
1300*	30 X 30	200	43
1305*	30 X 36	100	26
1306*	30 X 42	100	30
1307*	30 X 48	100	35
1308*	30 X 60	100	43
1304*	32 X 32	100	25
1309*	32 X 40	100	31
1311*	32 X 44	100	34
1312*	32 X 48	100	37
1313*	32 X 56	100	43
1316*	34 X 40	100	33
1317*	34 X 48	100	39
1310*	36 X 36	100	31
1315*	36 X 42	100	37
1320*	36 X 48	100	42
1322*	36 X 60	50	26
1319*	38 X 48	100	44
3155*	38 X 60	50	28
3302*	38 X 64	50	30
8727*	38 X 65	50	30
1324*	40 X 42	100	41
1325*	40 X 48	50	23
1327*	40 X 54	50	26
1330*	40 X 60	50	29
1331*	44 X 48	50	26
1335*	48 X 48	50	28
1337*	48 X 54	50	31
1340*	48 X 60	50	35
1342*	52 X 60	50	38
1344*	56 X 60	50	41

6 MIL LAYFLAT CASES

ITEM	W x L	CNT	WT
8135	4 X 6	1000	10
8145	4 X 10	1000	16
8185	5 X 7	1000	14
8190	5 X 8	1000	15
8220	6 X 8	1000	19
8225	6 X 9	1000	21
8230	6 X 10	1000	23
8235	6 X 12	1000	28
8270*	7 X 10	1000	27
8280*	7 X 14	1000	37
8290*	8 X 8	1000	24
8295*	8 X 10	1000	30
8300*	8 X 12	1000	36
8350*	9 X 12	1000	41
8355*	9 X 14	500	24
8360*	9 X 16	500	27
8385*	10 X 12	1000	45
8390*	10 X 14	500	27
8395*	10 X 16	500	30
8400*	10 X 18	500	34
8410*	10 X 24	500	45
8435*	12 X 12	500	27
8440*	12 X 14	500	32
8445*	12 X 16	500	36
8450*	12 X 18	500	41
8455*	12 X 20	500	45
8465*	12 X 30	250	34
8500*	14 X 16	500	42
8505*	14 X 18	250	24
8510*	14 X 20	250	27
8515*	14 X 24	250	32
8520*	14 X 30	250	40
8545*	16 X 18	250	28
8550*	16 X 20	250	30
8555*	16 X 24	250	36
8560*	16 X 30	250	45
8570*	18 X 18	250	31
8580*	18 X 24	250	41
8585*	18 X 30	200	41
8590*	18 X 36	100	25
8600*	20 X 20	250	38
8605*	20 X 24	250	45
8610*	20 X 30	200	45
8615*	20 X 36	100	28
8625*	24 X 24	200	44
8630*	24 X 30	100	28
8635*	24 X 36	100	33
8645*	24 X 48	100	44
8655*	28 X 32	100	34
8670*	28 X 48	50	26
8685*	30 X 36	100	41
8700*	30 X 60	50	34
8705*	36 X 36	50	25
8710*	36 X 48	50	33
8715*	36 X 60	50	41
8720*	38 X 48	50	35
8725*	38 X 60	50	43
8730*	38 X 65	50	47

BAGS ON ROLLS

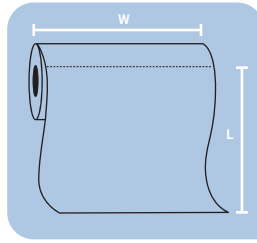

THE BASICS

Our Bags on Rolls demonstrate exceptional clarity for increased visibility. Ideal for hand loading product, these are manufactured with a perforation between the bags for easy dispensing.

- ▶ Easy to store – hang anywhere
- ▶ Bags stay neat – never folded

TECHNICAL DETAILS

Made from a performance blend of Low-Density Polyethylene (LDPE) that meets FDA/USDA specifications. These are heat sealable and feature a bottom seal construction. Rolls have 3" cores.

2 MIL LAYFLAT ON ROLLS

ITEM	W x L	CNT	WT
7715*	6 X 9	2000	14
7720*	8 X 10	1000	11
7725*	9 X 12	1000	14
7730*	10 X 16	1000	20
7735*	12 X 18	1000	27
7740*	16 X 20	1000	39
7745*	18 X 24	500	27
7750*	20 X 30	500	37
7751*	24 X 24	500	36
7753*	24 X 30	500	45
7755*	24 X 36	500	53
7760*	30 X 42	250	40
7765*	36 X 48	250	54
7770*	40 X 54	200	54
7775*	48 X 60	150	55

3 MIL LAYFLAT ON ROLLS

ITEM	W x L	CNT	WT
6905*	38 X 65	100	44

4 MIL LAYFLAT ON ROLLS

ITEM	W x L	CNT	WT
6820*	8 X 10	500	11
6825*	9 X 12	500	14
6830*	10 X 16	500	20
6835*	12 X 18	500	27
6845*	18 X 24	250	27
6850*	20 X 30	250	37
6855*	24 X 36	250	53
6860*	30 X 42	125	40
6865*	36 X 48	125	54
6919*	38 X 64	50	29
6920*	38 X 65	50	30
6875*	48 X 60	75	55

ROLL DISPENSERS

Made of steel, these can accommodate a roll of up to 13.5" in diameter.



ITEM	SIZE	CNT	WT
4830	12"	1	2
4832	24"	1	3

DURABLE BOTTOM SEALS & WELDS

Our state-of-the-art manufacturing equipment produces high strength bottom seal and side weld constructions. We take special pride in the durability we build into each bag.

Our side welded seams combine dependability and economy.

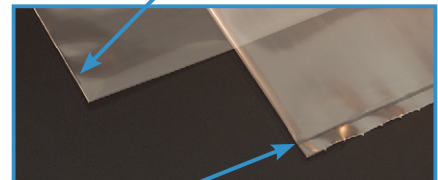

Precision bottom seals combined with tubular construction offer maximum strength.

* ENGINEERED AND MANUFACTURED IN THE U.S.A.

Layflat and Gusseted

CUSTOM CAPABILITIES

In addition to over 58 of our own extrusion lines in 5 manufacturing facilities, Laddawn offers extensive capabilities through Berry and 30 other partner plants. We can produce bags, tubing and sheeting in a wide array of materials, sizes and constructions, all built to your specification. Choose from 16 standard colors, 3 venting styles, printing capabilities and a host of performance additives to create your custom-tailored product.

MADE IN THE U.S.A.

To optimize clarity and strength, Laddawn-made medium and larger size items are engineered to provide over three times the impact and twice the tensile strength of traditional low-density polyethylene. Laddawn-made products are exclusively manufactured in the U.S.A. Laddawn is an ISO 9001 registered manufacturer.

ENERGY EFFICIENT

Laddawn uses energy efficient lighting, equipment and designs in our facilities. We also utilize renewable energy sources in many of our operational practices.

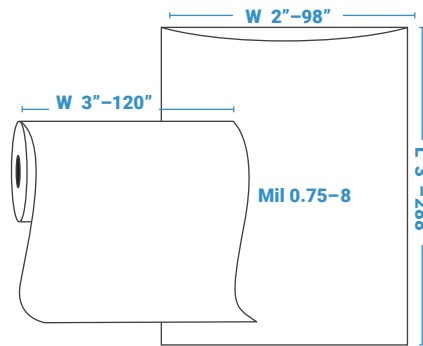

CUSTOM VENTING

Vented Bags W: 4"–98" W+D max. = 150"
Micro-Perforation W: 10"–60" W+D max. = 118"

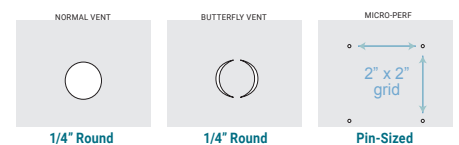
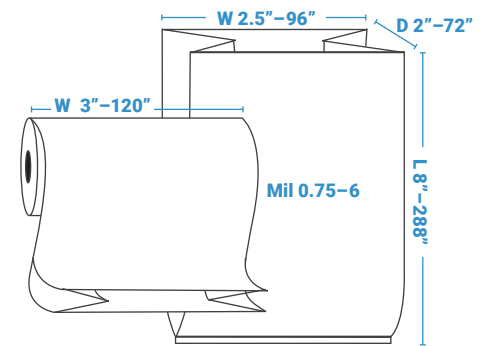

MATERIALS & ADDITIVES

- Anti-Block** For easy opening and loading
- Anti-Static** For static-dissipative film
- HDPE** High-Density Polyethylene for thinner, more economical film
- High Slip** For reduced friction between film
- LDPE** Low-Density Polyethylene for standard strength film
- LLD** High Strength Linear Low-Density
- LLDPE** Linear Low-Density Polyethylene for high strength film
- Metallocene** For high strength film or cold storage
- Non-Slip** To increase friction between film
- Non-Scratch** No anti-block for a smoother film surface
- Postal-Approved** Higher slip & anti-static for film used in USPS mailings
- UVI/UVA** Ultraviolet Inhibitor/Absorber to protect film and contents from the sun
- VCI** Vapor Corrosion Inhibitor to prevent rust

PACKAGING DETAILS

- Cases or Rolls** Loose in a case or on a roll for easy dispensing
- Case or Roll Count** Get the quantity that works best for your customer
- Boxed Rolls** Protect product prior to use
- Cradle Packed Rolls** Use less packaging, save money and provide more stable shipments
- Tray-Packed Rolls** Use less packaging, saves time unpacking

FILM COLORS (SWATCHES ARE APPROXIMATE)

	Black		Blue-Green
	Brown		Leaf Green
	Buff		Dark Green
	Gray		Red
	White		Orange
	Med. Blue		Yellow
	Sky Blue		Pink
	Baby Blue		Purple

Tint For film that you can see through in interior light
Color For film you may not see through in interior light
Opaque For film you cannot see through in interior light (black film only, minimum thickness 2.5 mil)

*Custom bags made to your approved specifications are not eligible for return.

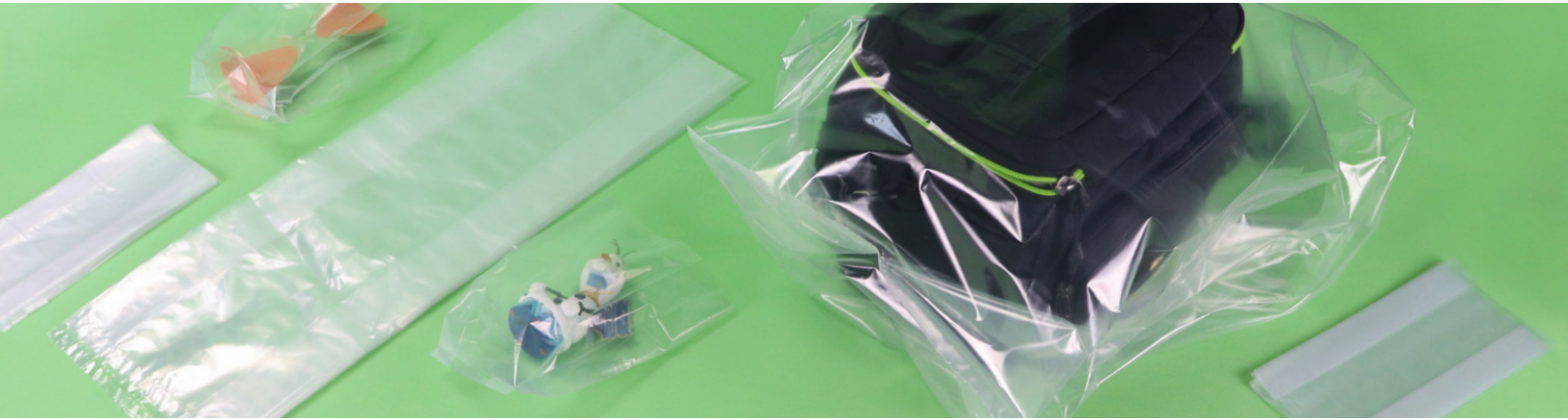

GUSSETED BAGS IN CASES

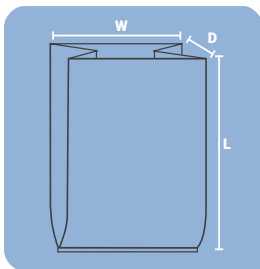

THE BASICS

Our Gusseted Bags are ideal for bulky or larger sized items and suitable for a wide range of applications. Like our Layflat Bags, these are manufactured with superior clarity and strength and maintain a durable bottom seal.

TECHNICAL DETAILS

Made from a performance blend of Low-Density Polyethylene (LDPE) that meets FDA/USDA specifications. These are heat sealable and feature a bottom seal construction.

* ENGINEERED AND MANUFACTURED IN THE U.S.A.

1 MIL GUSSETED

ITEM	WxDxL	CNT	WT
1345	4 X 2 X 8	1000	4
1347	4 X 2 X 10	1000	4
1350	4 X 2 X 12	1000	5
1355	5 X 2 X 12	1000	6
1360	5 X 3 X 15	1000	8
1361	5 X 3.5 X 12	1000	7
1363	5 X 4 X 15	1000	9
1378	5.5 X 4.75 X 19	1000	13
1366	6 X 3 X 12	1000	7
1365	6 X 3 X 15	1000	9
1370	6 X 3 X 18	1000	11
1375	6 X 4 X 15	1000	10
1374	6 X 4 X 20	1000	13
1380	8 X 3 X 15	1000	11
1385	8 X 3 X 20	1000	14
1390	8 X 4 X 15	1000	12
1395	8 X 4 X 18	1000	14
1393	10 X 4 X 20	1000	18
1396	10 X 6 X 20	1000	20
1398*	10 X 8 X 24	1000	27

1.25 MIL GUSSETED

ITEM	WxDxL	CNT	WT
1399*	20 X 18 X 30	250	22

1.5 MIL GUSSETED

ITEM	WxDxL	CNT	WT
1400	4 X 2 X 8	1000	5
1405	4 X 2 X 12	1000	7
1415	5 X 3 X 15	1000	12
1417	6 X 3 X 12	1000	10
1420	6 X 3 X 15	1000	13
1430	6 X 4 X 15	1000	14
1432	6 X 4 X 20	1000	18
1445*	8 X 4 X 15	1000	16
1450*	8 X 4 X 18	1000	20
1455*	10 X 4 X 20	1000	25
1465*	10 X 8 X 20	1000	32
1470*	10 X 8 X 24	1000	39
1475*	12 X 8 X 24	500	22
1480*	12 X 8 X 30	500	27
1482*	12 X 10 X 24	500	24
1486*	12 X 12 X 24	500	26

1.5 MIL GUSSETED

ITEM	WxDxL	CNT	WT
1493*	14 X 14 X 26	500	33
1485*	15 X 9 X 24	500	26
1496*	15 X 9 X 27	500	29
1490*	15 X 9 X 32	500	34
1491*	16 X 12 X 30	500	37
1497*	16 X 14 X 24	500	32
1498*	16 X 14 X 30	500	40
1495*	16 X 14 X 36	250	24
1499*	18 X 14 X 36	250	26
1500*	18 X 16 X 40	250	30
1508*	20 X 18 X 36	250	31
1505*	20 X 20 X 48	250	43
1503*	24 X 12 X 36	250	29
1510*	24 X 20 X 48	200	38
1515*	24 X 24 X 48	100	21
1516*	25 X 15 X 30	250	27
1517*	26 X 24 X 48	200	43
1518*	26 X 24 X 60	100	27
1520*	28 X 24 X 60	100	28
1514*	30 X 18 X 48	200	41
1525*	30 X 26 X 60	100	30

2 MIL GUSSETED

ITEM	WxDxL	CNT	WT
1530	4 X 2 X 8	1000	7
1533	4 X 2 X 10	1000	8
1535	4 X 2 X 12	1000	9
1540	5 X 2 X 12	1000	11
1545	5 X 3 X 15	1000	15
1547	6 X 3 X 12	1000	14
1550	6 X 3 X 15	1000	17
1555	6 X 3 X 18	1000	20
1560*	6 X 4 X 15	1000	18
1562*	6 X 4 X 20	1000	24
1565*	8 X 3 X 15	1000	20
1575*	8 X 4 X 15	1000	22
1580*	8 X 4 X 18	1000	26
1582*	8 X 4 X 22	1000	32
1585*	10 X 4 X 20	1000	34
1589*	10 X 6 X 20	1000	39
1590*	10 X 6 X 24	500	24
1595*	10 X 8 X 20	500	22
1600*	10 X 8 X 24	500	26

2 MIL GUSSETED

ITEM	WxDxL	CNT	WT
1605*	12 X 8 X 24	500	29
1610*	12 X 8 X 30	500	36
1611*	12 X 10 X 24	500	32
1612*	12 X 10 X 30	500	40
1613*	12 X 12 X 24	500	35
1621*	14 X 14 X 26	500	44
1615*	15 X 9 X 24	500	35
1620*	15 X 9 X 32	250	24
1617*	16 X 10 X 32	250	25
1618*	16 X 12 X 30	250	25
1619*	16 X 12 X 36	250	31
1623*	16 X 14 X 24	500	43
1624*	16 X 14 X 30	250	27
1625*	16 X 14 X 36	250	33
1627*	18 X 14 X 36	250	35
1630*	18 X 16 X 40	200	33
1622*	20 X 10 X 36	250	33
1636*	20 X 16 X 42	200	36
1637*	20 X 16 X 60	100	26
1638*	20 X 18 X 36	250	41
1635*	20 X 20 X 48	100	24
1629*	24 X 10 X 48	200	39
1632*	24 X 12 X 36	250	39
1640*	24 X 20 X 48	100	26
1645*	24 X 24 X 48	100	28
1647*	26 X 24 X 48	100	29
1648*	26 X 24 X 60	100	36
1649*	28 X 24 X 52	100	33
1650*	28 X 24 X 60	100	38
1646*	30 X 18 X 48	100	28
1655*	30 X 26 X 60	100	40

3 MIL GUSSETED

ITEM	WxDxL	CNT	WT
1665	4 X 2 X 12	1000	14
1675	5 X 3 X 15	1000	22
1680*	6 X 3 X 15	1000	25
1695*	8 X 3 X 15	1000	30
1705*	8 X 4 X 15	1000	32
1710*	8 X 4 X 18	1000	39
1712*	8 X 4 X 22	500	24
1715*	10 X 4 X 20	500	25
1717*	10 X 4 X 24	500	30

3 MIL GUSSETED

ITEM	WxDxL	CNT	WT
1719*	10 X 6 X 20	500	29
1725*	10 X 8 X 20	500	32
1730*	10 X 8 X 24	500	38
1735*	12 X 8 X 24	500	43
1740*	12 X 8 X 30	250	27
1738*	12 X 10 X 24	250	24
1739*	12 X 10 X 30	250	30
1742*	12 X 12 X 24	250	26
1743*	12 X 12 X 30	250	32
1749*	14 X 14 X 26	250	33
1745*	15 X 9 X 24	250	26
1750*	15 X 9 X 32	250	34
1746*	16 X 10 X 32	250	37
1747*	16 X 12 X 30	250	38
1753*	16 X 14 X 24	250	32
1754*	16 X 14 X 30	250	40
1755*	16 X 14 X 36	200	39
1756*	18 X 14 X 36	200	41
1760*	18 X 16 X 40	100	25
1751*	20 X 10 X 36	200	39
1762*	20 X 16 X 42	100	27
1764*	20 X 18 X 36	100	25
1765*	20 X 20 X 48	100	34
3296*	22 X 16 X 60	100	41
3281*	23 X 10 X 40	100	24
1757*	24 X 10 X 36	200	44
1758*	24 X 10 X 48	100	29
1759*	24 X 12 X 36	100	23
1770*	24 X 20 X 48	100	38
1775*	24 X 24 X 48	50	21
3287*	25 X 17 X 48	100	36
1776*	26 X 24 X 48	50	22
1777*	26 X 24 X 60	50	27
1774*	30 X 18 X 48	50	21
1785*	30 X 26 X 60	50	30

4 MIL GUSSETED

ITEM	WxDxL	CNT	WT
3276*	16 X 14 X 36	100	26
3282*	23 X 10 X 40	100	32
3289*	25 X 17 X 48	50	25

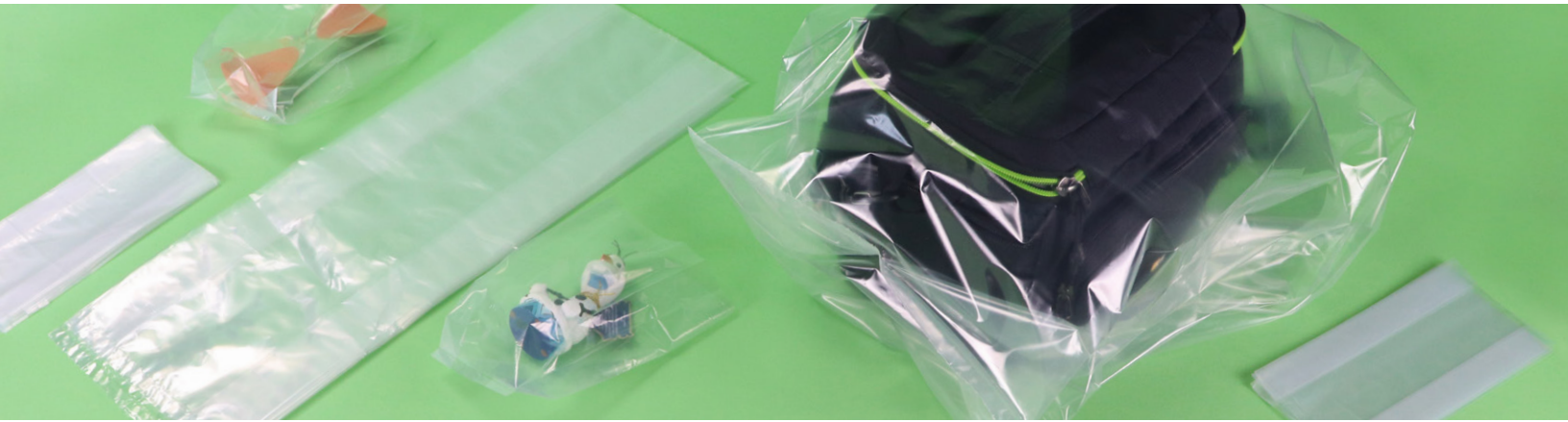

GUSSETED BAGS ON ROLLS

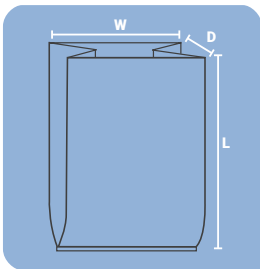

THE BASICS

Our Gusseted Bags on Rolls are designed with a tear perforation for easy dispensing and hand product loading. These are suitable for a wide range of applications and are ideal for large or bulky items.

TECHNICAL DETAILS

Made from a performance blend of Low-Density Polyethylene (LDPE) that meets FDA/USDA specifications. These are heat sealable and feature a bottom seal construction.

* ENGINEERED AND MANUFACTURED IN THE U.S.A.

1 MIL GUSSETED

ITEM	WxDxL	CNT	WT
1395R*	8 X 4 X 18	1000	14
1398R*	10 X 8 X 24	1000	28
1400R*	48 X 42 X 48	150	43

1.25 MIL GUSSETED

ITEM	WxDxL	CNT	WT
9975*	54 X 44 X 96	100	78

1.5 MIL GUSSETED

ITEM	WxDxL	CNT	WT
1485R*	15 X 9 X 24	500	27
1495R*	16 X 14 X 36	250	25
1508R*	20 X 18 X 36	250	32
1510R*	24 X 20 X 48	200	39
1515R*	24 X 24 X 48	100	22
1517R*	26 X 24 X 48	200	44
1525R*	30 X 26 X 60	100	32
10000*	32 X 28 X 48	200	53
10010*	32 X 28 X 72	135	54
10045*	36 X 28 X 60	160	57
10095*	36 X 36 X 60	130	53
10110*	42 X 32 X 54	140	53
10115*	42 X 32 X 60	130	54
10160*	44 X 36 X 80	100	60
10170*	44 X 36 X 96	80	58
10195*	46 X 44 X 80	70	48
10180*	48 X 36 X 72	110	63
10210*	48 X 46 X 72	75	48
10215*	48 X 46 X 96	60	51
10240*	51 X 49 X 73	75	52
10242*	51 X 49 X 85	60	49
10245*	51 X 49 X 97	50	47
10250*	52 X 48 X 96	60	55
10255*	52 X 48 X 108	50	51
10225*	53 X 42 X 78	65	46
10230*	54 X 44 X 72	75	51
10235*	54 X 44 X 96	60	54
10265*	58 X 46 X 96	60	57
10270*	58 X 46 X 108	50	54

2 MIL GUSSETED

ITEM	WxDxL	CNT	WT
1580R*	8 X 4 X 18	1000	27
1600R*	10 X 8 X 24	500	27
1605R*	12 X 8 X 24	500	30
1625R*	16 X 14 X 36	250	33
1638R*	20 X 18 X 36	250	42
1639R*	23 X 17 X 46	200	46
1640R*	24 X 20 X 48	100	27
1655R*	30 X 26 X 60	100	42
10300*	32 X 28 X 48	160	57
10305*	32 X 28 X 60	130	58
10310*	32 X 28 X 72	110	59
10315*	32 X 28 X 84	90	56
10320*	32 X 28 X 96	80	57
10345*	36 X 28 X 60	130	62
10370*	36 X 32 X 48	160	65
10375*	36 X 32 X 60	130	66
10390*	36 X 36 X 48	125	54
10400*	36 X 36 X 72	80	52
10410*	42 X 32 X 54	110	55
10415*	42 X 32 X 60	100	56
10420*	42 X 32 X 72	80	54
10425*	42 X 32 X 84	70	55
10460*	44 X 36 X 80	75	61
10465*	44 X 36 X 88	70	62
10470*	44 X 36 X 96	60	58
10475*	44 X 36 X 108	55	60
10495*	46 X 44 X 80	55	51
10500*	46 X 44 X 100	45	52
10435*	48 X 30 X 60	100	59
10440*	48 X 30 X 72	80	57
10480*	48 X 36 X 72	80	61
10485*	48 X 36 X 96	60	61
10490*	48 X 42 X 48	100	57
10510*	48 X 46 X 72	60	52
10515*	48 X 46 X 96	45	52
10520*	48 X 46 X 126	35	53
10522*	51 X 49 X 73	55	51
10523*	51 X 49 X 85	50	54
10524*	51 X 49 X 97	40	50

2 MIL GUSSETED

ITEM	WxDxL	CNT	WT
10550*	52 X 48 X 96	45	55
10555*	52 X 48 X 108	40	55
10525*	53 X 42 X 78	55	52
10530*	54 X 44 X 72	60	54
10535*	54 X 44 X 96	45	54
10545*	54 X 44 X 132	30	50
10565*	58 X 46 X 96	45	58
10575*	58 X 46 X 125	35	58
10580*	68 X 65 X 82	50	70

3 MIL GUSSETED

ITEM	WxDxL	CNT	WT
1755R*	16 X 14 X 36	200	40
1764R*	20 X 18 X 36	100	26
1775R*	24 X 24 X 48	50	22
1776R*	26 X 24 X 48	50	23
1785R*	30 X 26 X 60	50	32
1800R*	48 X 46 X 72	45	57
1815R*	51 X 49 X 85	35	56
1817R*	51 X 49 X 97	30	52
1825R*	54 X 44 X 72	40	54
1820R*	54 X 44 X 96	30	54

4 MIL GUSSETED

ITEM	WxDxL	CNT	WT
10600*	32 X 28 X 48	80	57
10605*	32 X 28 X 60	65	58
10610*	32 X 28 X 72	55	59
10615*	32 X 28 X 84	45	56
10620*	32 X 28 X 96	40	57
10645*	36 X 28 X 60	65	62
10655*	36 X 28 X 96	40	61
10670*	36 X 32 X 48	80	65
10675*	36 X 32 X 60	65	66
10690*	36 X 36 X 48	60	52
10695*	36 X 36 X 60	50	54
10700*	36 X 36 X 72	40	52
10705*	36 X 36 X 108	25	49
10630*	40 X 22 X 72	55	62

4 MIL GUSSETED

ITEM	WxDxL	CNT	WT
10710*	42 X 32 X 54	55	55
10715*	42 X 32 X 60	50	56
10720*	42 X 32 X 72	40	54
10725*	42 X 32 X 84	35	55
10790*	44 X 36 X 80	35	57
10760*	44 X 36 X 88	35	62
10770*	44 X 36 X 108	25	55
10772*	44 X 44 X 70	25	40
10795*	46 X 44 X 80	35	63
10800*	46 X 44 X 100	30	68
10735*	48 X 30 X 60	50	59
10775*	48 X 36 X 72	40	61
10810*	48 X 46 X 72	35	60
10815*	48 X 46 X 96	25	57
10817*	50 X 44 X 57	25	36
10819*	50 X 48 X 84	25	53
10818*	51 X 49 X 73	30	56
10820*	51 X 49 X 85	25	54
10821*	51 X 49 X 97	20	50
10822*	52 X 43 X 70	25	43
10850*	52 X 48 X 96	25	61
10860*	52 X 48 X 120	20	61
10825*	53 X 42 X 78	35	66
10830*	54 X 44 X 72	30	54
10835*	54 X 44 X 96	25	60
10840*	54 X 44 X 120	20	60
10845*	54 X 44 X 132	20	65
10865*	58 X 46 X 96	25	64
10875*	58 X 46 X 125	20	66
10878*	68 X 65 X 82	25	70