



**EndurEnergy Systems, Inc.**



# **ESP-5100**

**Residential  
ESS Manual**



EndurEnergy Systems, Inc.



## About this manual

This manual is intended for the ESP-5100 Lithium Iron Phosphate (LiFePo<sub>4</sub>) Battery. These batteries can be installed in parallel configuration only. Please pay close attention to the DIP switch setting, address selection and cable connections.

## Statement

This product is compliant with the Best Practice Guide for Battery Storage Equipment—Electrical Safety, version 1. It meets the mandatory requirements of Method 1 for pre-assembled integrated battery energy storage system equipment, as well as the optional requirements listed under points a), c), e), f), g), h), i), j), k), l), m), n), o), p), and q).

## Declaration

EndurEnergy declares that the ESP-5100 is compliant with the essential requirements and other relevant standards of UL/CE.

## Disclaimer

EndurEnergy cannot be responsible for system failure, damage, or injury resulting from improper installation of their products. The information included in this manual is subject to change without notice.

## CONTENT

1	Safety Introduction .....	1
1.1	Important Safety Instructions .....	1
1.2	Warnings in this Document .....	1
1.3	Battery Handling Guide.....	2
1.4	Response to Emergency Situations.....	2
1.4.1	Leaking Batteries.....	2
1.4.2	Fire.....	3
1.4.3	Wet battery .....	3
1.4.4	Damaged Battery.....	4
1.5	Installers.....	4
1.6	Disposing Batteries .....	4
1.7	Contact Information.....	4
2	Guidance for Disconnection of Batteries During Shipment.....	5
3	Product Introduction .....	6
3.1	Technical Specifications .....	6
3.2	Indicators and Ports.....	7
3.2.1	Indicators .....	7
3.2.2	Ports .....	7
3.2.3	Communication Interface .....	8
3.3	Typical Battery application.....	9
3.4	Feature.....	10
4	Installation Prerequisites.....	11
4.1	Installation Process .....	11
4.2	Installation Location.....	11
4.3	Tools.....	12
4.4	Personal protective equipment (PPE).....	12
4.5	Storage.....	13
5	Battery Installation .....	13
5.1	Package Items .....	13
5.2	Package Items – EMP Hardened System.....	14
5.3	Before Installation.....	15
5.4	Battery Mounting.....	16
5.4.1	Rack Mounting (R6 / R12).....	16
5.4.2	Enclosure Mounting - (BU10/15/20/30).....	19
5.5	Cable Connections of the Battery.....	22
5.5.1	Battery Grounding .....	23
5.5.2	Power Cable Connection (Parallel - Low Voltage application) .....	24
5.5.3	Power Cable Connection (Parallel – EMP Low Voltage application).....	26
5.5.4	Communication Cables.....	27
5.6	Battery DIP Switch Setting .....	31



EndurEnergy Systems, Inc.



6	Battery connectivity.....	36
6.1	APP Setup.....	36
6.1.1	Connect the Battery to the Internet.....	36
6.1.2	Visualize Battery Data from the App.....	40
7	Commissioning.....	41
7.1	Commissioning Battery.....	41
7.2	Shutting Down Battery.....	42
7.3	Battery charger parameters.....	42
8	Firmware Update & Troubleshooting .....	42

## 1 Safety Introduction

### 1.1 Important Safety Instructions







This manual contains crucial instructions for the **ESP-5100 Residential ESS product**. It is **imperative to follow this manual during installation and use of the product**.

While this product is designed and tested to meet international safety requirements such as UL1973, CE, IEC 62040, and IEC 62619, it is essential to take certain precautions when installing and/or operating any electrical and electronic equipment. To minimize the risk of personal injury and ensure the safe installation and operation of the product, it is crucial to thoroughly read and adhere to all instructions, cautions, and warnings provided in this manual.

<b>WARNING</b>
<p>Failure to follow the instructions or warnings in this document can result in electrical shock, serious injury, or death. Damage to the Battery is also possible, potentially rendering it inoperable.</p> <p>High Life Risk Due to Fire or Electrocution – ONLY qualified personnel should install the ESP-5100.</p>

### 1.2 Warnings in this Document

A warning indicates a potential hazard to equipment or personnel. It highlights procedures or practices that, if not performed correctly, may result in damage to or destruction of the equipment, other connected equipment, or personal injury.

Symbol	Description
	Caution, risk of electric shock
	Heavy enough may cause severe injury
	Keep the battery away from open flame or ignition sources
	Keep the battery away from children
	Dispose of waste batteries according to local laws and regulations
	Recycling
	Read this manual before installation and operation



EndurEnergy Systems, Inc.



For safety reasons, it is the responsibility of installers to thoroughly review the contents of this manual and familiarize themselves with all warnings prior to performing the installation.

### 1.3 Battery Handling Guide

Please follow the guidelines below to ensure safe handling and usage of the battery pack:

- Use the battery pack only as directed.
- If the battery appears cracked, broken, damaged, or fails to operate, immediately contact EndurEnergy hot line at 1-888-E2-ENDUR (1-888-323-6387).
- Do not attempt to open, disassemble, repair, tamper with, or modify the battery in any way.
- The battery is not suitable for users to handle independently.
- When transporting the battery, handle it with care to protect the battery and its components from damage.
- Avoid subjecting the battery to any strong force or impact.
- Do not insert foreign objects into any part of the battery pack.
- Refrain from using cleaning solvents to clean the battery.
- Never connect the battery directly to a SELV (Separated Extra-Low Voltage) circuit.

### 1.4 Response to Emergency Situations

While the ESP-5100 Residential ESS is equipped with multiple safety features to prevent hazards caused by failures, it is important to note that EndurEnergy cannot guarantee absolute safety in uncertain situations.

#### 1.4.1 Leaking Batteries

In the event of electrolyte leakage from the battery pack, it is crucial to avoid contact with the leaking liquid or gas. Electrolyte is corrosive and can cause skin irritation and chemical burns. If you are exposed to the leaked substance, please follow these actions:

- Inhalation:
  - Evacuate the contaminated area immediately.
  - Seek medical attention without delay.
- Eye contact:
  - Rinse your eyes with flowing water for at least 15 minutes.
  - Seek medical attention promptly.
- Skin contact:
  - Wash the affected area thoroughly with soap and water.
  - Seek medical attention as soon as possible.
- Ingestion:



EndurEnergy Systems, Inc.



- If the electrolyte is ingested, promptly induce vomiting.
- Seek immediate medical attention.

The previous instructions are provided to address potential risks associated with electrolyte leakage. It is important to prioritize your safety and seek professional medical assistance without delay in case of exposure to the leaked substance.

### 1.4.2 Fire

In the event of a fire, it is important to have an ABC or carbon dioxide extinguisher readily available. Do not use water to extinguish the fire.



#### WARNING

The battery pack may catch fire when heated above 150°

If a fire breaks out where the battery is installed, please follow these actions:

- Prioritize extinguishing the fire before the battery catches fire if it is safe to do so. Use appropriate fire extinguishing methods and equipment according to the type of fire (e.g., ABC or carbon dioxide extinguisher). Ensure your safety and consider seeking professional assistance if necessary.
- If the battery has already caught fire or if it is not safe to attempt extinguishing the fire, prioritize the immediate evacuation of all individuals from the area. Follow established emergency evacuation procedures and ensure everyone moves to a safe location. Contact the appropriate emergency services to report the fire.

Note: The above actions are intended to address fire situations where the battery is involved. Always prioritize personal safety and adhere to established emergency procedures.

#### WARNING

If the battery catches fire, it will produce poisonous gases. Do not approach.

### 1.4.3 Wet battery

If the battery becomes wet or submerged in water, do not attempt to access it. Instead, please contact EndurEnergy Customer Service or reach out to your distributor for immediate technical assistance.



#### 1.4.4 Damaged Battery

If you notice any damage to the battery, please contact EndurEnergy customer service or your distributor for assistance as soon as possible. It is crucial to handle a damaged battery with extreme caution, as it can be dangerous. A damaged battery is not suitable for use and may pose a risk to people and property. If you suspect the battery is damaged, promptly return it to EndurEnergy or your distributor.

<b>CAUTION</b>
A damaged battery may potentially release electrolyte or flammable gas.

### 1.5 Installers

It is highly recommended that the installation of the ESP-5100 Residential ESS is carried out by a skilled worker or electrician. A skilled worker is defined as an individual who has received proper training and possesses the necessary qualifications as an electrician, or has acquired the following skills and experience:

- Comprehensive knowledge of the functional principles and operation of on-grid Energy Storage systems.
- Understanding of the potential dangers and risks associated with the installation and use of electrical devices, as well as familiarity with acceptable mitigation methods.
- Proficiency in the installation of electrical devices.
- Familiarity with and adherence to the instructions provided in this manual, including all safety precautions and best practices.

### 1.6 Disposing Batteries

When dealing with scrap battery(-ies), it is important to comply with local laws and regulations regarding the recycling or disposal of batteries. Please ensure that you follow the appropriate procedures as outlined by your local authorities for recycling or disposing of Lithium Iron Phosphate batteries.

### 1.7 Contact Information

For technical assistance, please use the contacts provided. Please note that the phone numbers are available for assistance during business hours on weekdays.





EndurEnergy Systems, Inc.



<b>Customer careline</b>	1-888-E2-ENDUR (1-888-323-6387)
<b>Email</b>	support@endurenergy.com

## 2 Guidance for Disconnection of Batteries During Shipment

- The ESP-5100 is not suitable for air transport.
- Cartons that have been crushed, punctured, or torn in such a way that the contents are revealed shall be set aside in an isolated area and inspected by a skilled person. If the package is deemed to be non-shippable, the contents shall be promptly collected, segregated, and either the consignor or consignee should be contacted.
- The battery has been turned off prior to shipping.
- We have conducted comprehensive tests to ensure that the equipment distributed worldwide is safe for shipping. These products should be handled with care and immediately inspected if visibly damaged. If the carton is visibly damaged, please contact EndurEnergy customer service to confirm whether the battery can be used safely or not.



EndurEnergy Systems, Inc.



### 3 Product Introduction

#### 3.1 Technical Specifications

<b>Product Type</b>	ESP-5100
<b>Total Energy*</b>	5.12 kWh
<b>Usable Energy (DC)*</b>	5.12 kWh
<b>Nominal Voltage</b>	51.2 VDC
<b>Max. Continuous Discharge/Charge Power</b>	3.0 kW
<b>Peak Power (Only Discharge)</b>	5.12 kW for 3s
<b>Operation Voltage</b>	42~54 VDC
<b>Maximum Discharge Current</b>	60A
<b>Maximum Charge Current</b>	60A
<b>Maximum Charge Voltage</b>	56 VDC
<b>Weight</b>	42 kg 92.4 lb
<b>Dimensions</b>	442 x 500 x 133 mm 17.4 x 19.7 x 5.2 inch
<b>Max. Recommended Depth of Discharge (DOD)</b>	90%
<b>Operating Condition</b>	Indoor use
<b>Charge Temperature Range</b>	0 to 45 °C (32 to 113 °F)
<b>Discharge Temperature Range</b>	-10 to 55 °C (14 to 131 °F)
<b>WIFI Frequency Range</b>	2400 MHz-2483 MHz
<b>Humidity Limit</b>	<60% (no condensed water)
<b>Over Voltage Category</b>	II
<b>Cooling Type</b>	Natural cooling
<b>Case Material</b>	Steel
<b>Color</b>	White
<b>Installation</b>	Cabinet or Rack mounting
<b>IP Rating</b>	IP 20
<b>Protective Class</b>	I
<b>Max. Number of Parallel Connections</b>	16S/16P
<b>Warranty</b>	10-Year
<b>Lifespan</b>	> 15 years
<b>Communication Protocols</b>	CAN/ RS485
<b>Protection Mode</b>	Triple hardware protection
<b>Battery Protection</b>	Over-Current/Over-Voltage/Short Circuit
<b>Certificates</b>	UL1973, UL9540, CEC, SGIP
<b>Testing</b>	EMC
<b>Hazardous Material Classification</b>	9
<b>Transportation</b>	UN 38.3

\*Testing conditions based on temperature 25 °C at the beginning of life.

\*Total Energy/Usable Energy measured under specific conditions from ESP 0.2C CC-CV.

### 3.2 Indicators and Ports

#### 3.2.1 Indicators

There are two LED indicators on the front of the battery that show its operating status.



Item	Designation	Definition
1	Run	Steady: The battery is working normally. Blinking: Reset Button pressed, expecting Wifi connection from App.
2	Fault	There are failures or issues with the battery. See troubleshooting or contact EndurEnergy Tech Support.

#### 3.2.2 Ports

The power cable interface and the communication cable interface are shown in the following image.

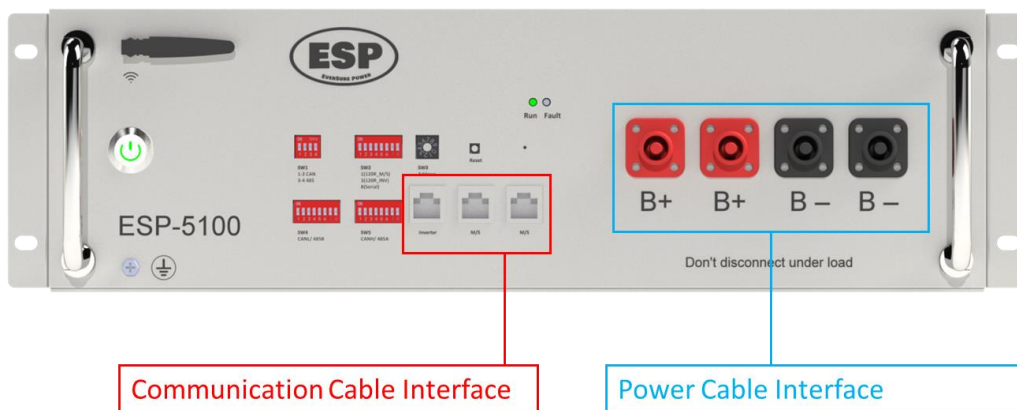

### 3.2.3 Communication Interface

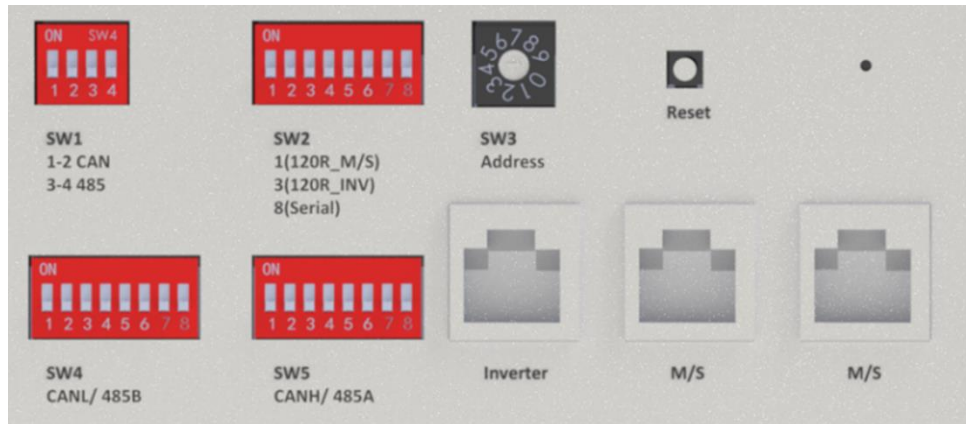

**NOTICE**

For switches: SW1, SW2, SW4 and SW5; the “ON” position means the number is on the upper side.

Designation	Definition
SW 1	The DIP switch is used to select the communication mode between CAN and RS485. Please refer to the inverter's user manual for detailed instructions. <ul style="list-style-type: none"> <li>For CAN Communication, set SW1 to positions 1 and 2 “ON”.</li> <li>For RS485 Communication, set SW1 to positions 3 and 4 “ON”.</li> </ul>
SW 2	The communication resistance and DIP switch settings for parallel or series connections.  <b>(See Section 5.5)</b>
SW 3	Used for setting the battery address in a multiple battery system setup.  <b>(See Section 5.5)</b>
SW 4	Used for communication between the primary battery and the inverter. <ul style="list-style-type: none"> <li>Factory standard setting: position 5 “ON”.</li> </ul>
SW 5	Used for communication between the primary battery and the inverter. <ul style="list-style-type: none"> <li>Factory standard setting: position 4 “ON”.</li> </ul>
Reset	Used to reset the Wi-Fi or GPPS/GPS module configuration.

Inverter	Ethernet port used for communication between the primary battery and the inverter.
M/S	Ethernet ports used for communication between batteries.

**NOTICE**

The battery is designed to work on a close loop environment for communicating with a Sol-Ark inverter or compatible inverter (check inverter compatibility list), for open loop type of applications we do not ensure proper operation and not encourage it. If you intend to use the battery on an open loop application or not supported inverter, call our technical support.

### 3.3 Typical Battery application

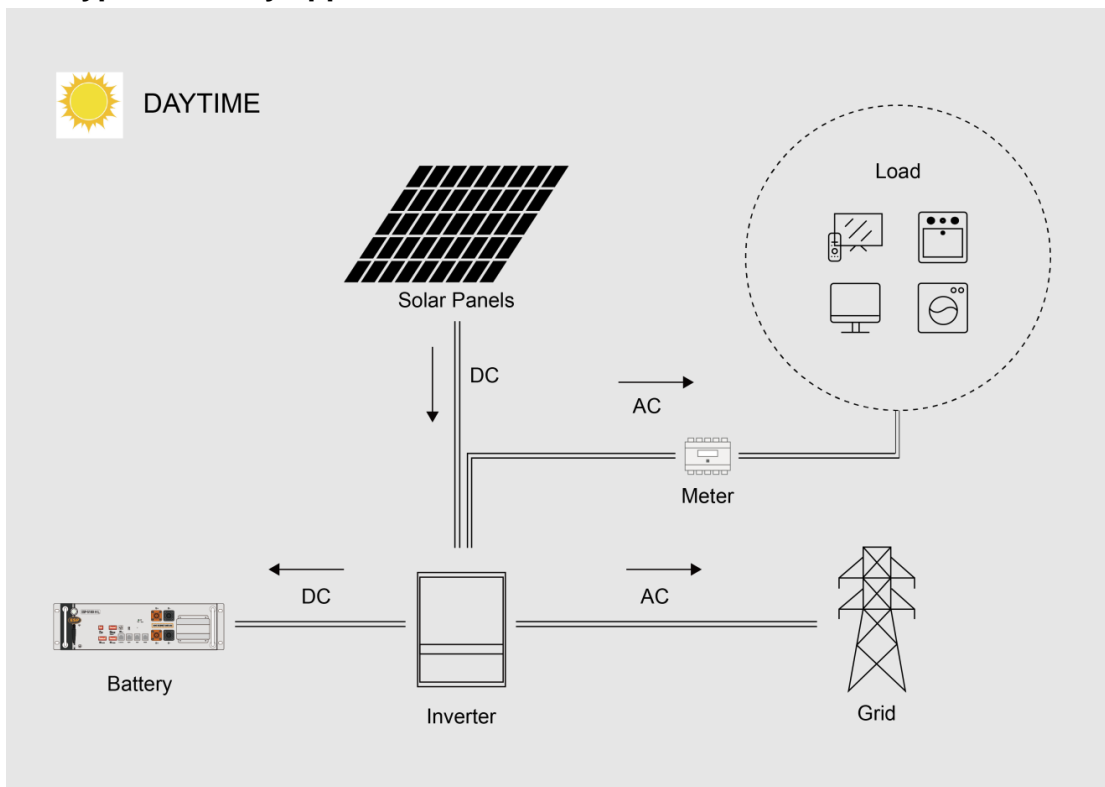

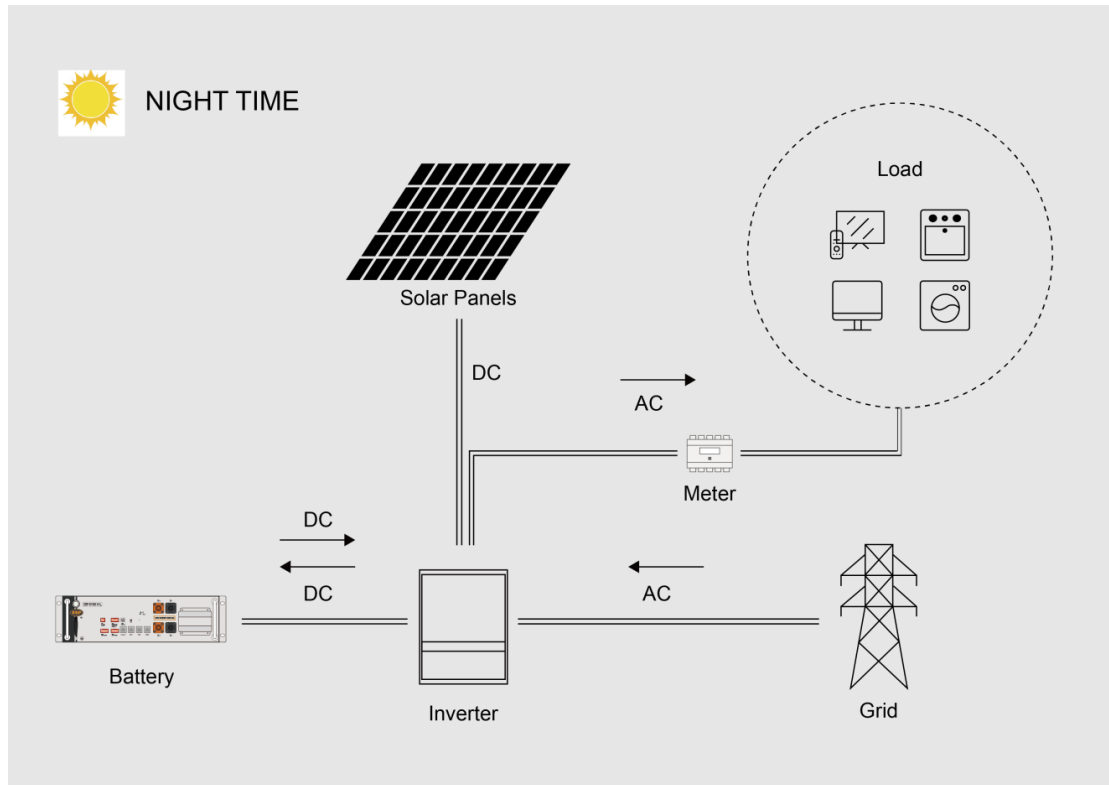

### 3.4 Feature

The ESP-5100 battery has the following features:

- **Energy storage unit:** This battery is suitable for compatibility with photovoltaic systems.
- **Battery management system (BMS):** The battery has a built-in BMS that monitors its operation and prevents it from operating outside the design limitations.
- **Monitor:** The battery's built-in BMS is equipped with a Wi-Fi module, allowing users to monitor the battery's operating information on mobile phones and computers.
- **Easy firmware update:** The BMS firmware can be easily updated to the latest version.
- **Expandability:** The battery capacity can be increased by adding another battery.

## 4 Installation Prerequisites

### 4.1 Installation Process

The battery should be installed according to the following flowchart. The detailed installation process is described in Section **Battery Installation**.

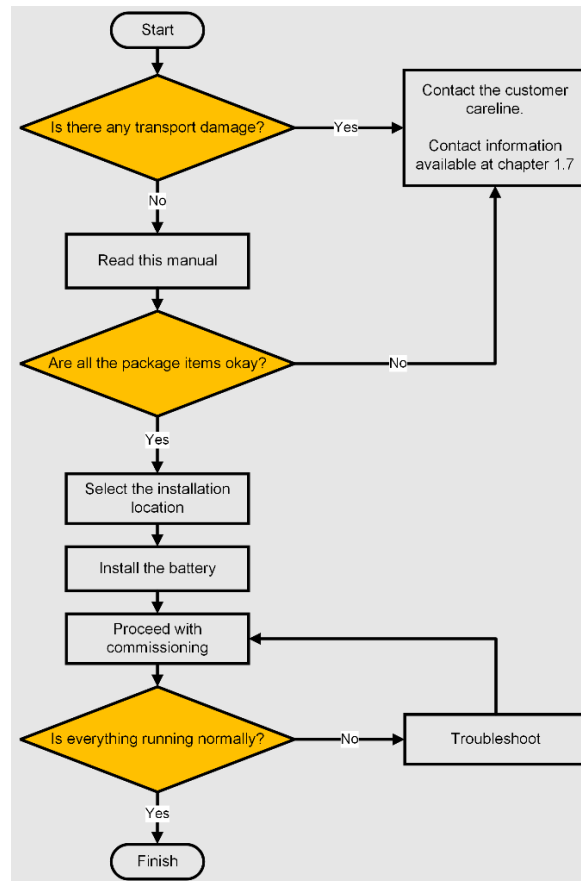

### 4.2 Installation Location

Ensure that the installation location meets the following conditions:

- The building is designed to withstand earthquakes as per the building code (when applicable).
- It is far away from the sea to avoid saltwater and humidity.
- The floor is flat and level.
- There are no flammable or explosive materials nearby.
- The optimal ambient temperature is between 15°C and 30°C.
- The temperature and humidity remain at a constant level.
- There is minimal dust and dirt in the area.

- There are no corrosive gases present, including ammonia and acid vapor.
- The battery and racks are rated IP20, indicating that they are suitable for indoor use, if required to be placed outside it will require an enclosure or cabinet.

If the ambient temperature is outside the operating range, the battery will protect itself by shutting down. The optimal operating temperature for the battery is 15°C to 30°C. Frequent exposure to severe operating conditions would negatively affect the performance and lifespan of the battery.

### 4.3 Tools

To install the battery pack, the following tools are required:

			
<b>Flat-head &amp; Phillips Screwdriver</b>	<b>Torque wrench</b>	<b>Cable crimper</b>	<b>Wire clamp</b>
			
<b>Voltmeter</b>	<b>Measuring tape</b>	<b>Drill</b>	<b>Bubble Level</b>

To ensure the safety of the operator and installer, please select and use suitable tools and measuring instruments that are certified for precision and accuracy.

### 4.4 Personal protective equipment (PPE)

When handling the battery, the following safety gear should be worn. Installers must comply with the relevant requirements of UL1973, IEC 62040, and IEC 62619, or applicable domestic legislation and other relevant international standards.

		
<b>Insulated gloves</b>	<b>Safety goggles</b>	<b>Dielectric Safety shoes</b>



## 4.5 Storage

If the battery is not going to be installed immediately and needs to be stored for a long period, please choose an appropriate location for storage. Follow these instructions for storage:



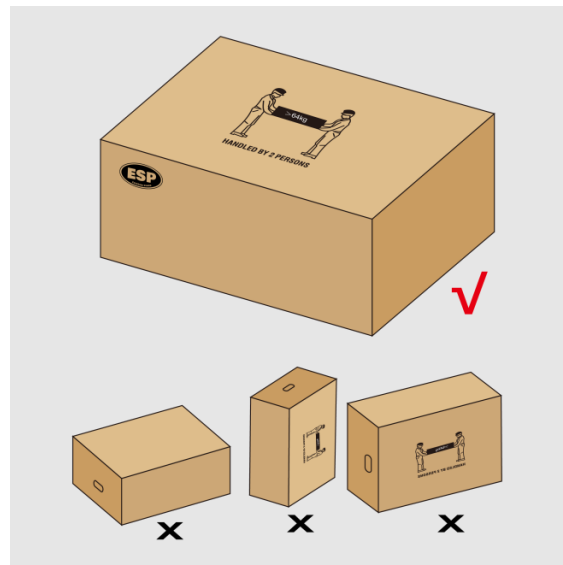

- Do not stack more than four battery boxes.
- The recommended storage temperature for the battery is in the range of -20°C to 30°C.
- Avoid exposing the battery to water.
- If the battery needs to be stored for over 3 months, it will discharge at a minimum rate and the capacity may degrade depending on the storage time.
- If the battery is stored for over 6 months, it is recommended to connect the battery with the inverter and commission the system.
- The battery boxes should be stored upright as shown in the following figure and should not be stacked upside down.



## 5 Battery Installation

### 5.1 Package Items

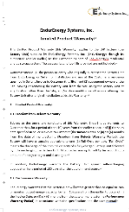

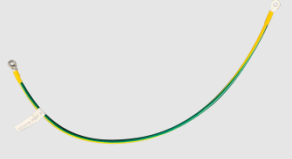



You will receive one packing carton containing the batteries. The items included are summarized as follows:

		
<b>1 x ESP-5100</b>	<b>1 x User Manual</b>	<b>1 x Warranty Letter</b>
		
<b>1 x Communication Cable</b>	<b>1 x Power Cables</b>	<b>1 x Grounding Wire</b>

Note: Product accessories are customized according to customer needs. This list represents only the standard accessories. Endur does not provide cables for all situations, for special projects ask sales team.

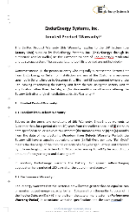
## 5.2 Package Items – EMP Hardened System

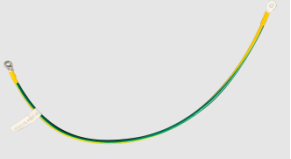
You will receive one packing carton containing the batteries. The items included are summarized as follows:

		
<b>1 x ESP-5100</b>	<b>1 x User Manual</b>	<b>1 x Warranty Letter</b>
		
<b>1 x Communication Cable</b>	<b>1 x Power Cables</b>	<b>1 x Grounding Wire</b>
		
<b>2 x Suppressors</b>	<b>1 x Hardware Package</b>	



EndurEnergy Systems, Inc.



Note: Product accessories are customized according to customer needs. This list represents only the standard accessories. Endur does not provide cables for all situations, for special projects ask sales team.

### **5.3 Before Installation**

There are a few things to check before installing the battery to ensure that it is free of defects.

Check the battery voltage using the following instructions:

- Press and hold the power button for 4 seconds and release it when two indicators turn on.
- Measure the voltage at the terminal interface using a voltmeter. If the voltage is lower than 48V, do not use the battery and contact customer service.
- Turn off the battery after checking voltage.

## 5.4 Battery Mounting

The ESP-5100 is designed as a rack mount type battery, this adds flexibility on installation and modularity for different configurations. We offer different rack and enclosure solutions for our batteries, see instructions below depending of the type of mounting.

### 5.4.1 Rack Mounting (R6 / R12)

1. Place the Rack in the location desired (refer to the details about the installation location described in [Chapter 4.2](#)). The enclosure should be moved close to its installation location inside its shipping container before it is unpacked. The enclosure must be installed in a structurally sound area with a level floor that is able to bear the weight of the rack + the intended number of batteries to be installed inside.

#### CAUTION

Our rack solutions are designed for indoor installations IP20/NEMA1.  
If the batteries are intended to be used outdoors, a cabinet / enclosure is required.  
**Our Racks are designed for high voltage / series applications, if you intend to use the rack for the ESP-5100 battery please ask a sales representative for special cables and busbars available.**

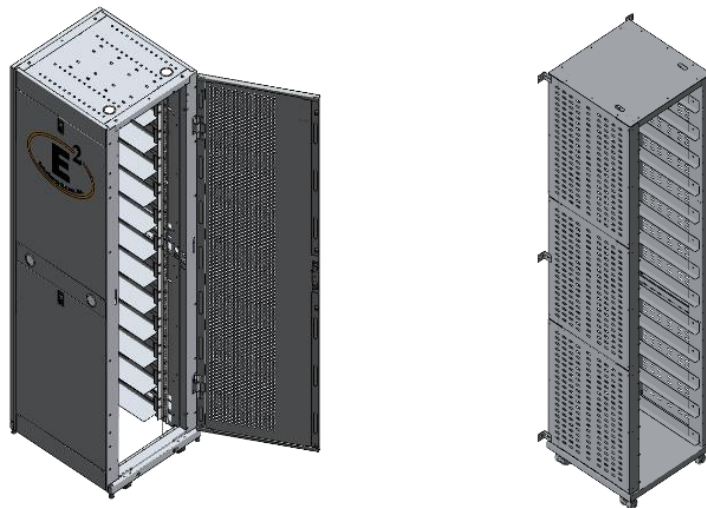

2. Adjust leveler feet (if included), lower each leveler unit it reaches the floor, make sure each leveler contacts the floor solidly. After lowering each leveler, use the carpenter's level / bubble level to confirm that the rack is level. Adjust levelers as needed to get level.

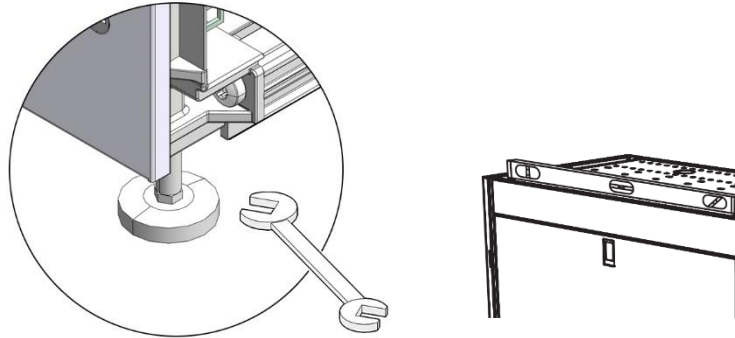

3. To secure the rack to the building structure for stability, attach the provided brackets to the wall or to the floor (depending on the rack model) using adequate screws. Verify foundation for seismic installations.

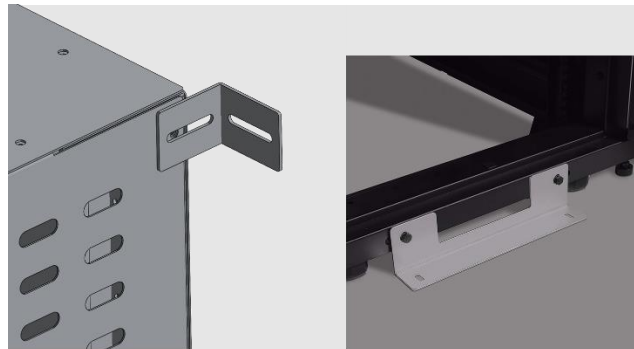

- Slide in each battery into the horizontal brackets of the rack, each battery shall be spaced out vertically around 1/3 U (0.6" / 15 mm) to ensure heating dissipation. Use M6 screws to secure the batteries in place to cage nuts, max torque of 8.7 lb\*ft. If Rack does not have cage nuts, use the appropriate screws to fix into the predrilled holes.

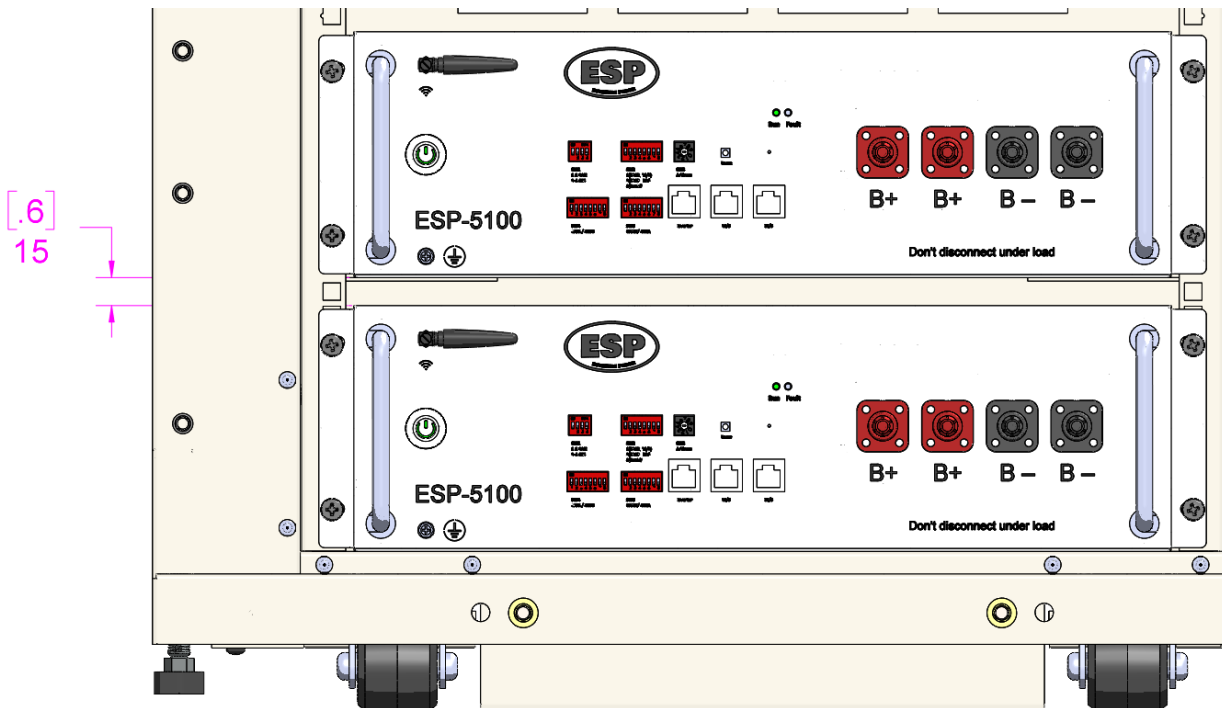
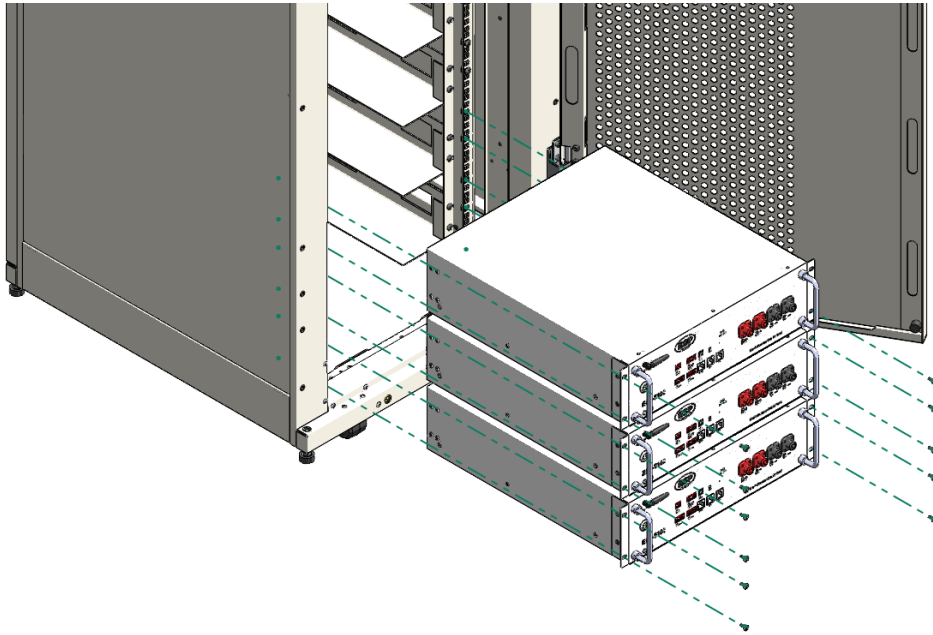

## 5.4.2 Enclosure Mounting - (BU10/15/20/30)

1. Place the enclosure in the location desired (refer to the details about the installation location described in [Chapter 4.2](#)). The enclosure should be moved close to its installation location inside its shipping container before it is unpacked. The enclosure must be installed in a structurally sound area with a level floor that is able to bear the weight of the enclosure + the intended number of batteries to be installed inside.

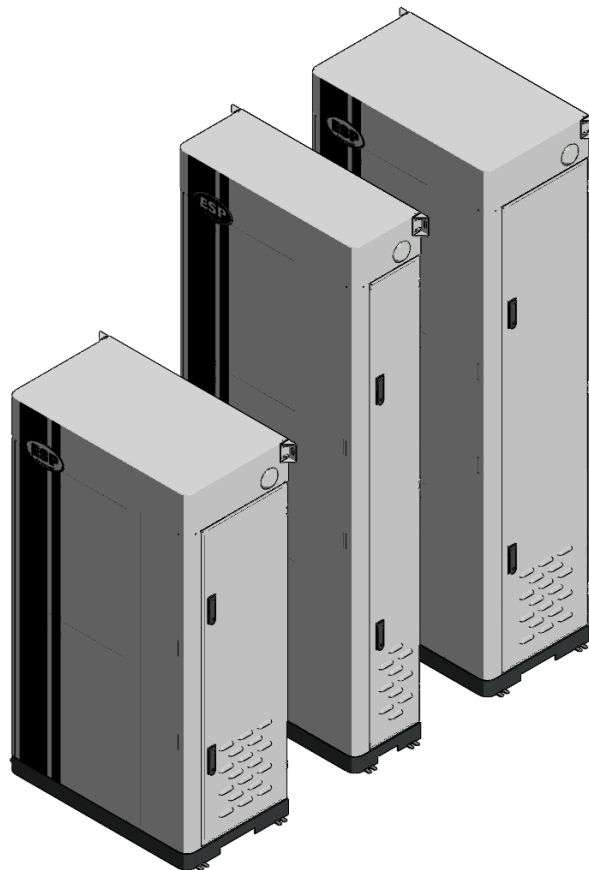

### NOTICE

Our enclosure solutions are designed for outdoor installations rated IP55 / NEMA 3R.  
**Our BU30 enclosure is intended for high voltage / series applications, if you intend to use the ESP-BU30 enclosure with the ESP-5100 battery please ask sales representative for special cables and busbars available.**

2. To secure the enclosure to the building structure for stability, adjust the 2x wall brackets by losing the screws, move the brackets to leave a gap of at least 0.5" between the wall and the enclosure to allow airflow and door opening. Tighten the screw brackets and attach both brackets to the wall with 2x adequate screws (M8 or 5/16").

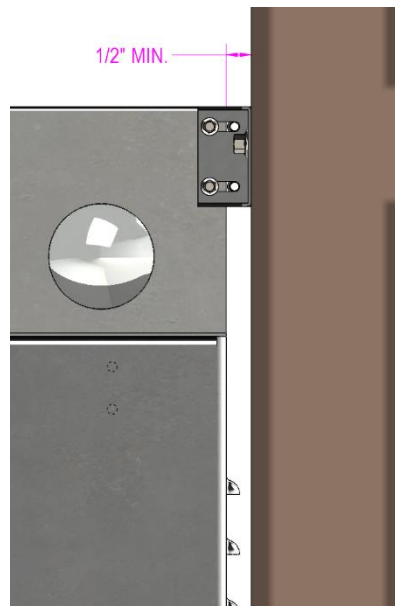
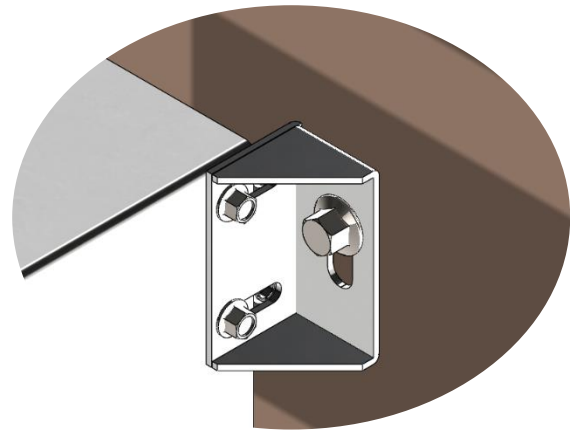
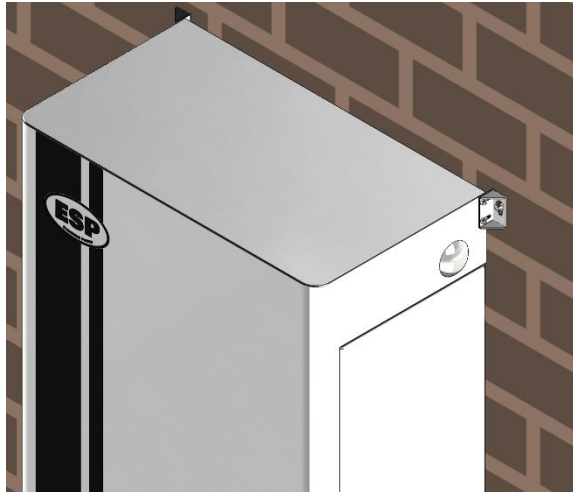



3. Fix the enclosure to the floor by using 4x adequate screws (M8 or 5/16"). Verify foundation for seismic installations.

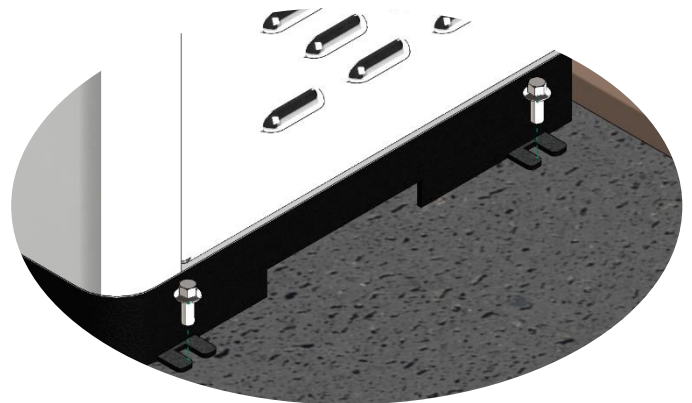
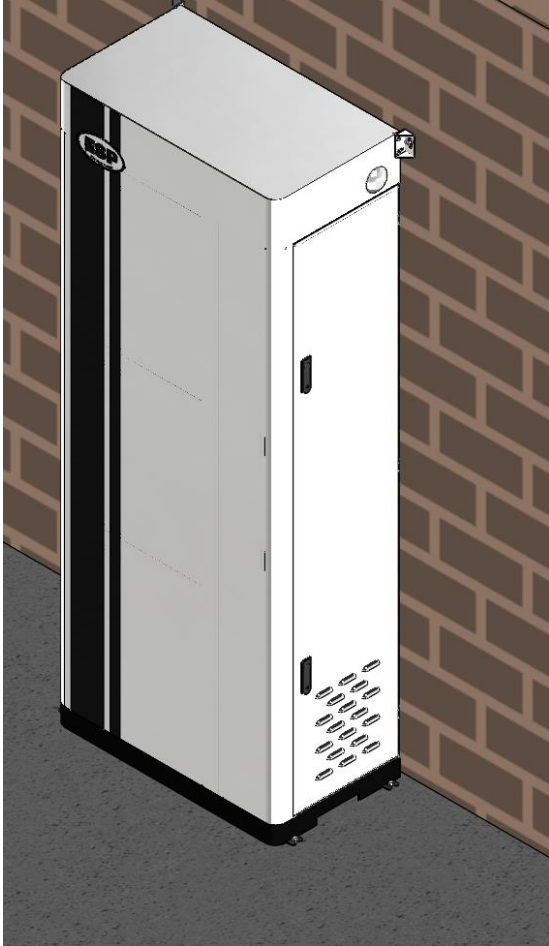

- Slide in each battery into the enclosure, the battery enters vertically. Use M6 screws to fix into the predrilled holes and secure the batteries in place, max torque of 8.7 lb\*ft.

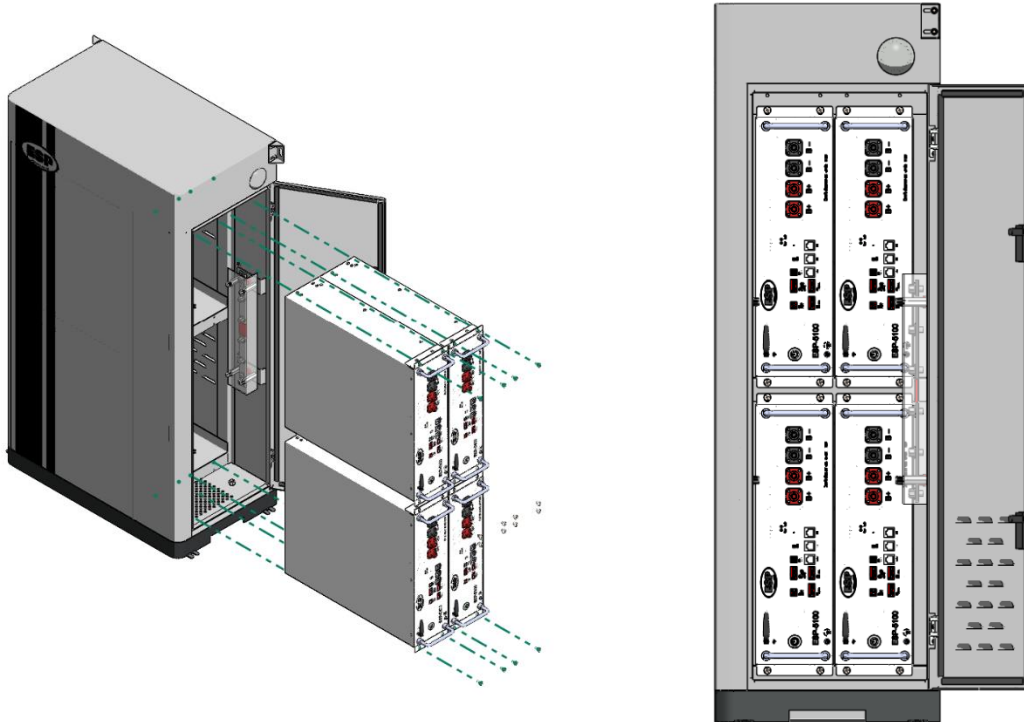

## 5.5 Cable Connections of the Battery

### WARNING

Connect the cables in accordance with local installation laws and regulations. Before connecting the cables, ensure that the battery is turned OFF. Failure to do so may result in electric shocks.

Make sure the cap is on if you don't need to use the power interface.



### 5.5.1 Battery Grounding

There is a grounding icon on the front of the battery that indicates the grounding screw of the battery, connect the grounding wire on this screw and make sure all the batteries grounds are interconnected, this ground shall also be connected to the bonding ground of the inverter or PCS where the batteries will be installed, the ground bonding system shall be installed as per NEC Article 250 or local regulations.

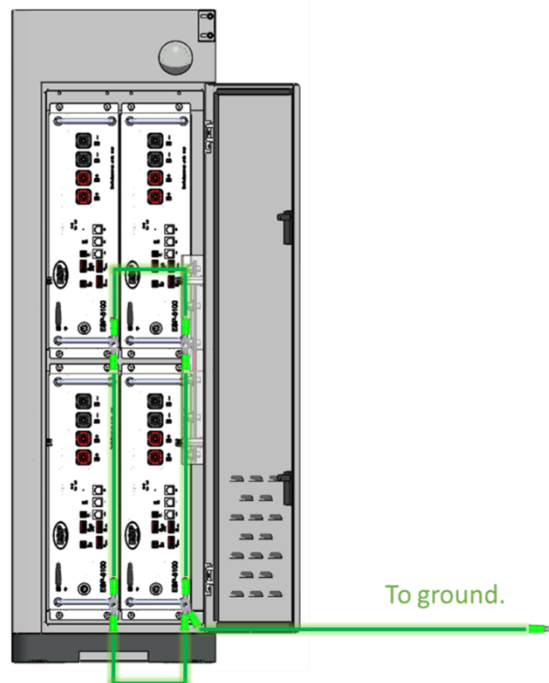
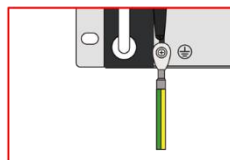

### 5.5.2 Power Cable Connection (Parallel - Low Voltage application)

**NOTICE**

Before two or more batteries are connected in parallel, please check the voltage of each battery and make sure the voltage difference is less than 2.0V.

A parallel connection for 3 batteries is shown in the below schematic, the positive terminal of all batteries is commonly wired, the same will be to the negative terminal, the main negative terminal of the full system (B-) is common negative and the main positive terminal (B+) is a common positive. The circuit shown below will have a nominal DC voltage of around 50VDC and a nominal charge/discharge current of 150A; this circuit is also called a string.

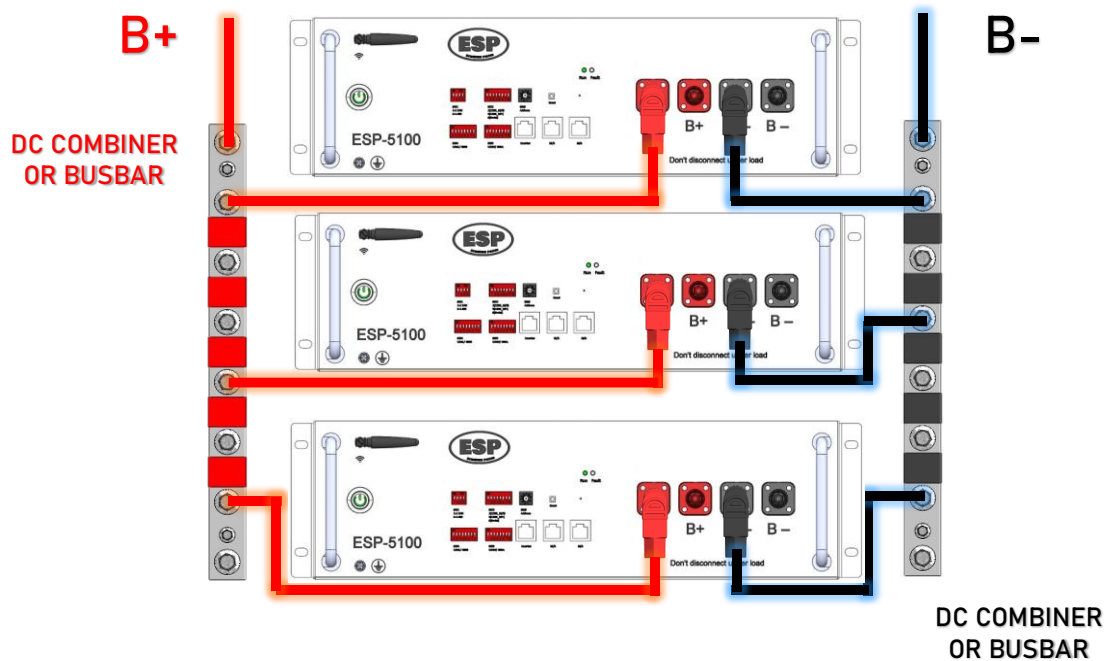

The main negative and positive terminal of the string will connect to the battery input of the inverter or PCS.

**NOTICE**

ESP-5100 does not include a breaker, it is required to add an external circuit breaker for the batteries if the inverter does not have one included.

The maximum possible ESP-5100 to put in parallel is 10 (51.2KWh), if the system requires more batteries in parallel then an ESP-BCU shall be added, the BCU setup is not part of the scope of this manual, refer to ESP-BCU Manual for setting up more than 10 ESP-5100 batteries in parallel.

**5.5.2.1 Parallel connection example: 1 string of 4\*ESP-5100 to a SA-12K inverter**

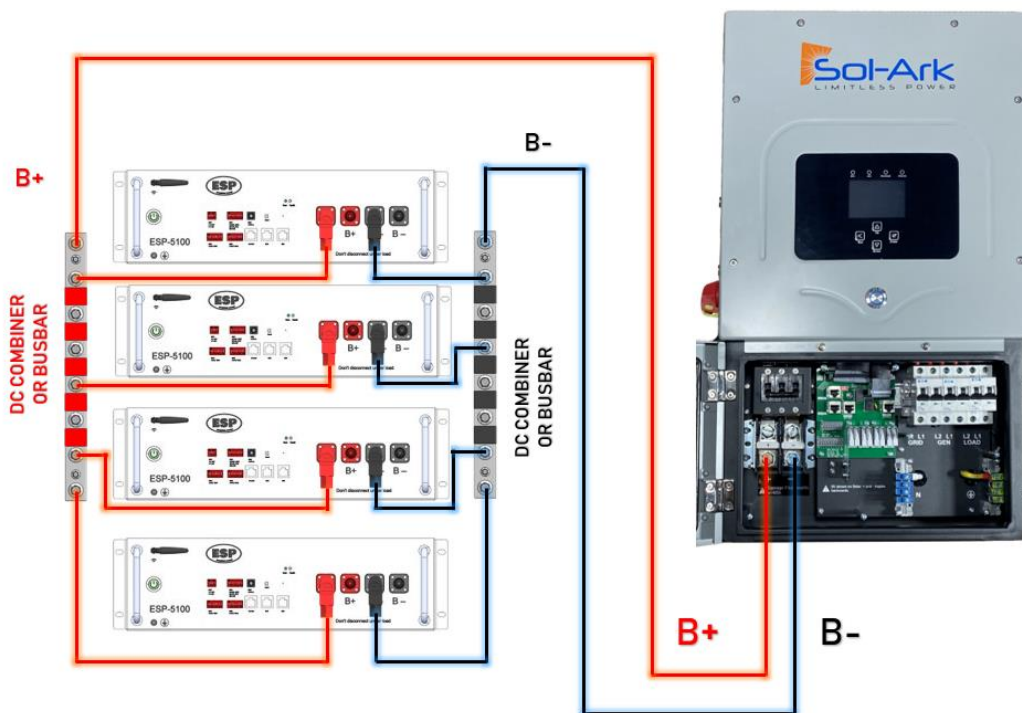

**WARNING**

Always follow Inverter's installation manual prior to making any connection.  
This manual does not substitute inverter manual.

### 5.5.3 Power Cable Connection (Parallel – EMP Low Voltage application)

If you purchased an ESP-5100 EMP, the primary protection is integrated within the battery package. Additionally, EMP suppressors are supplied to ensure safeguarding of the battery terminals. Each ESP-5100 EMP includes two suppressors, which should be installed on the power cord as near to the battery terminal as feasible.

A parallel connection for 3 batteries is shown in the below schematic, the positive terminal of all batteries is commonly wired, the same will be to the negative terminal, the main negative terminal of the full system (B-) is common negative and the main positive terminal (B+) is a common positive. The circuit shown below will have a nominal DC voltage of around 50VDC and a nominal charge/discharge current of 150A; this circuit is also called a string.

**NOTICE**

Before two or more batteries are connected in parallel, please check the voltage of each battery and make sure the voltage difference is less than 2.0V.

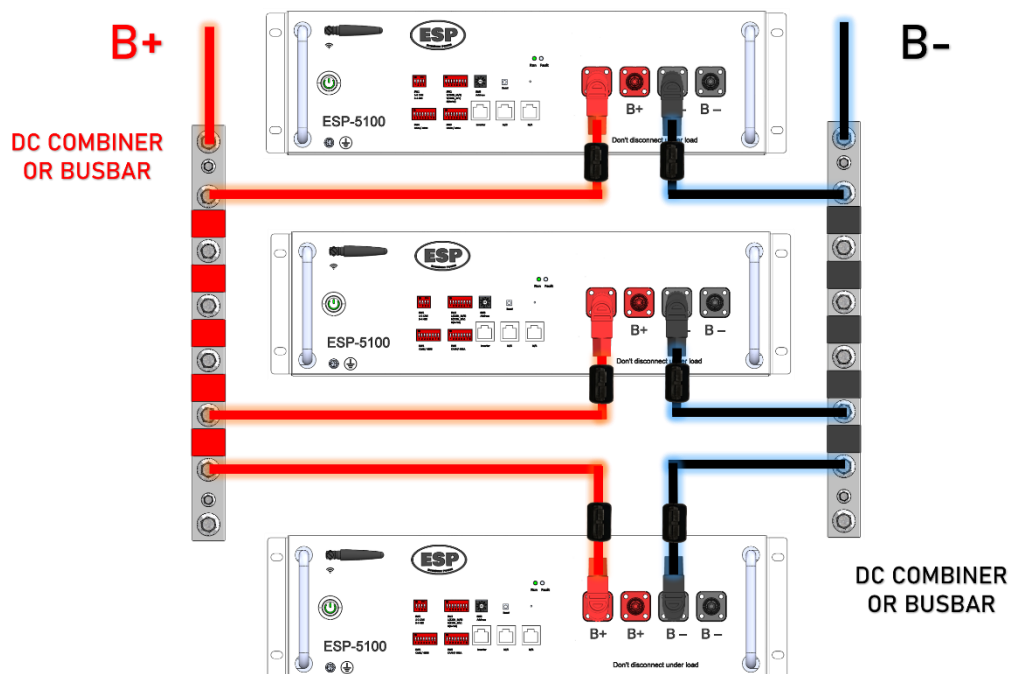

The main negative and positive terminal of the string will connect to the battery input of the inverter or PCS.

### 5.5.3.1 Parallel EMP System Example: 1 string of 4 \* ESP-5100 EMP to a SA-12K EMP Hardened Inverter

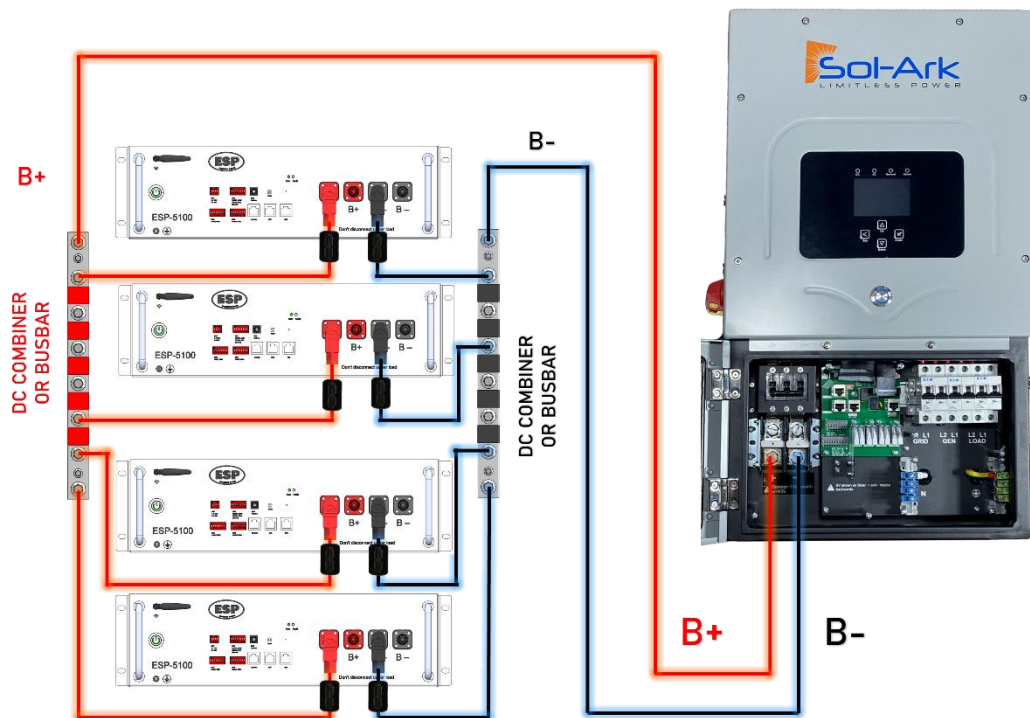

#### WARNING

Always follow Inverter's installation manual prior to making any connection.  
This manual does not substitute inverter manual.

### 5.5.4 Communication Cables

Each battery includes a BMS (Battery Management System) that allows for communication with compatible inverters, the communication is done through an ethernet cable UTP CAT6 with RJ45 connector, it accepts RS485 and CAN BUS.

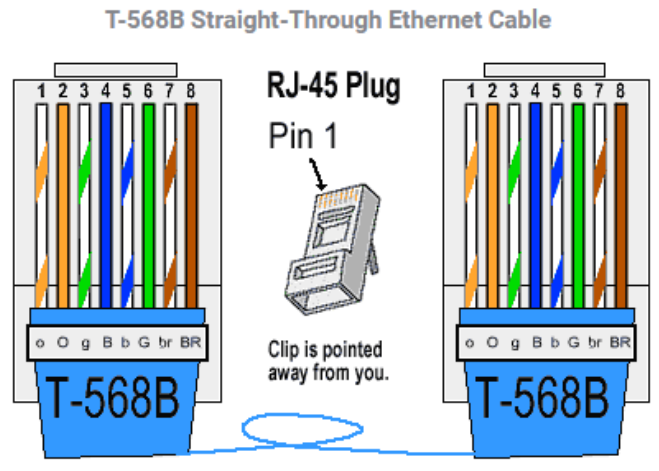

There are no special cable requirements for the wiring of these ethernet cables as long as all cables are wired the same, standard T-568B is recommended.

#### 5.5.4.1 Connecting Batteries for communication

When connecting two or more batteries in parallel, all the batteries must have communication between each other using a communication cable connected between their M/S Port.

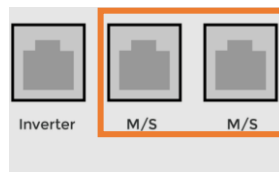
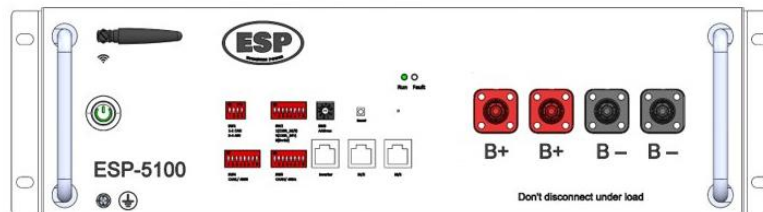



Connect all batteries in the string with a communication cable between their M/S Port. See diagram below for an example of 3 batteries connected.

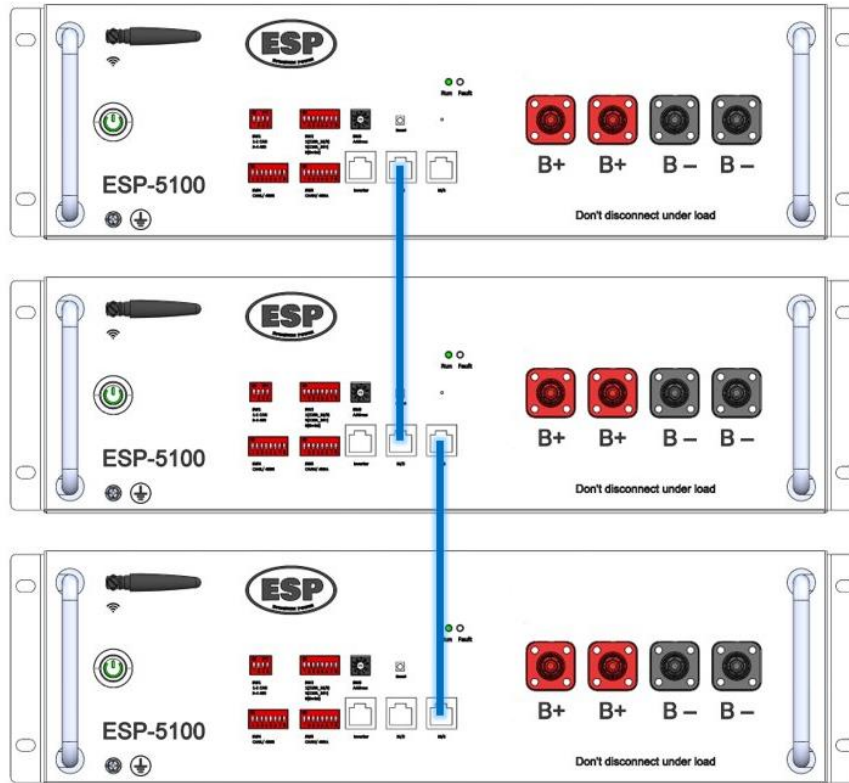

#### 5.5.4.2 Connecting Battery string for communication with inverter

##### NOTICE

The battery is designed to work on a close loop environment for communicating with the inverter / PCS (check inverter compatibility list), for open loop type of applications we do not ensure proper operation.

To ensure proper functionality of the batteries, the batteries must communicate to the main inverter through the supported protocols using a communication cable. Refer to the inverter compatibility list (not included in this manual).

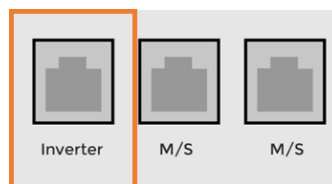

In a battery string only one of the batteries will acquire the role of Primary or Master (See [section 5.5](#)), this Primary battery will connect to the main inverter with the communication

cable, this allows the inverter to see all the batteries as a single bank. The primary battery will use the “Inverter” Port for that purpose.

#### 5.5.4.2.1 Communication connection example: 1 string of 4\*ESP-5100 to a SA-12K inverter

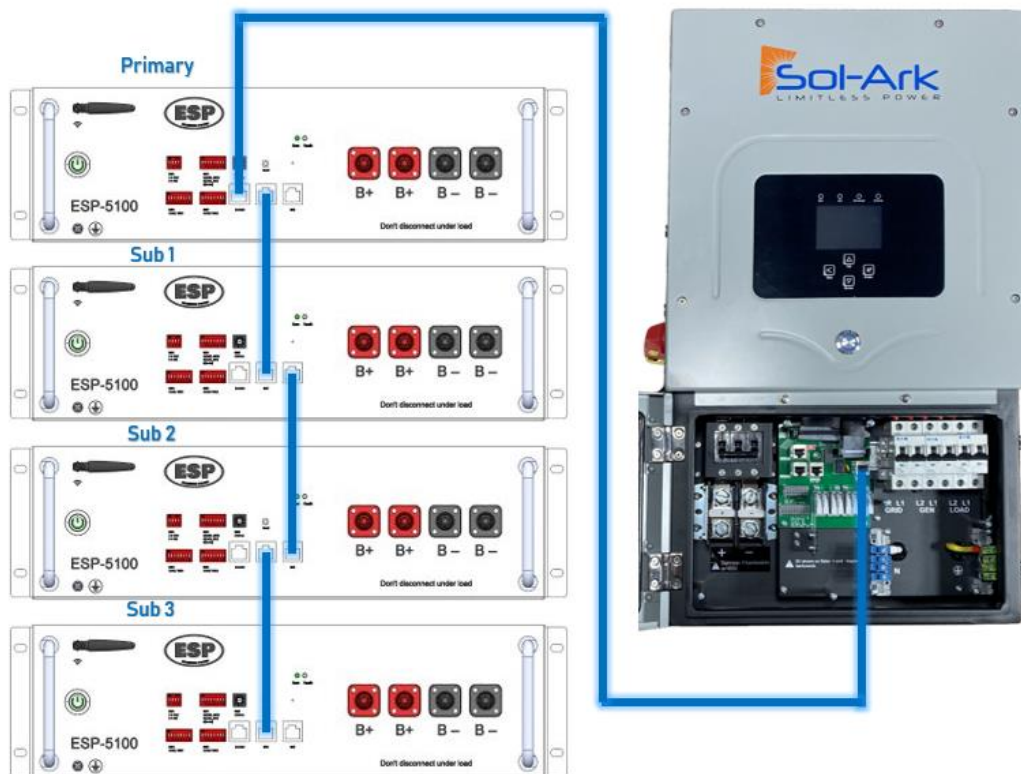

### WARNING

Always follow Inverter’s installation manual prior to making any connection.  
This manual does not substitute inverter manual.

### NOTICE

Once you completed the wiring for communication, verify the inverter manual or with inverter technical support for the correct settings on the inverter to properly ensure communication.

## 5.6 Battery DIP Switch Setting

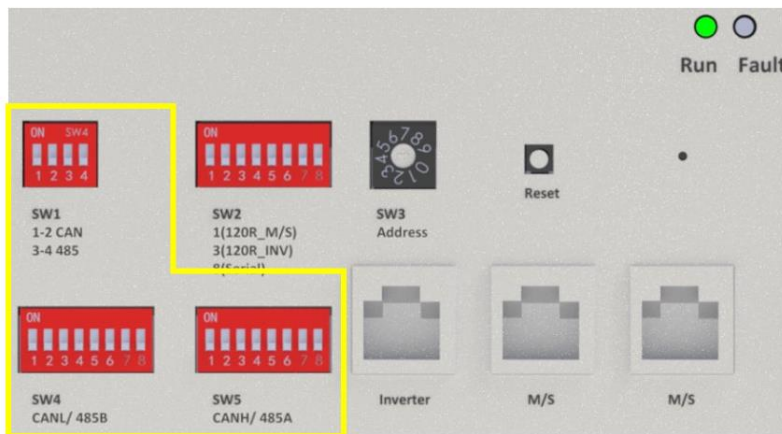
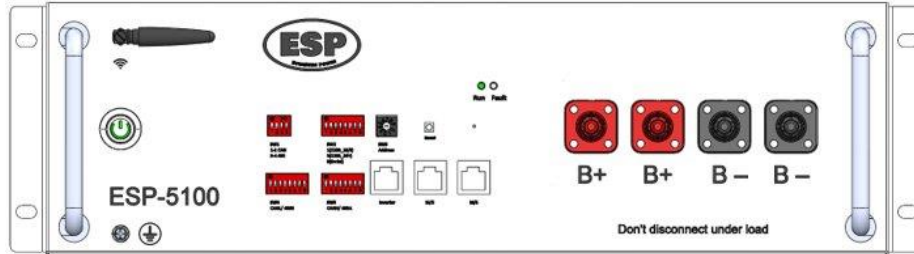

The settings for SW1/SW4/SW5 are defined in the inverter's user manual.

### NOTICE















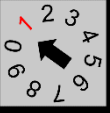

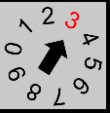



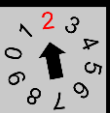

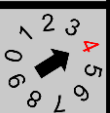
For switches: SW1, SW2, SW4 and SW5; the “ON” position means the number is on the upper side.

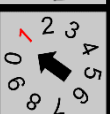
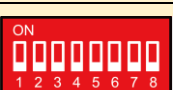
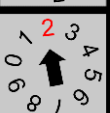
### WARNING

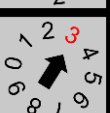
Please ensure that the SW1/SW4/SW5 settings are correctly set to the manufacturer's default and have not been accidentally changed.

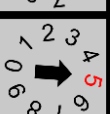
The default communication protocol for the battery is CAN (SW1: 1 & 2 on). If the inverter's communication mode is RS485 or any other protocol, please contact EndurEnergy before installing the battery.  
SW4 default: 5 on; SW5 default: 4 on.

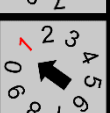
In the following table, you will find the configurations for **SW2** and **SW3**. This table includes configurations for 1 battery up to 10 batteries. Identify the actual number of batteries of your system/string and adjust the switches accordingly.

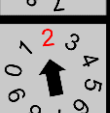
Number of Batteries connected	Group	Set of SW 2		Address (Set of SW3)
		Parallel connect		
1	/			
2	Primary			
	Sub 1			
3	Primary			
	Sub 1			
	Sub 2			
4	Primary			
	Sub 1			
	Sub 2			
	Sub 3			
5	Primary			
	Sub 1			
	Sub 2			



EndurEnergy Systems, Inc.



	Sub 3		
	Sub 4		
6	Primary		
	Sub 1		
	Sub 2		
	Sub 3		
	Sub 4		
	Sub 5		
7	Primary		
	Sub 1		
	Sub 2		
	Sub 3		
	Sub 4		
	Sub 5		
	Sub 6		



EndurEnergy Systems, Inc.



8	Primary		
	Sub 1		
	Sub 2		
	Sub 3		
	Sub 4		
	Sub 5		
	Sub 6		
	Sub 7		
9	Primary		
	Sub 1		
	Sub 2		
	Sub 3		
	Sub 4		
	Sub 5		
	Sub 6		



EndurEnergy Systems, Inc.



	Sub 7		
	Sub 8		
10	Primary		
	Sub 1		
	Sub 2		
	Sub 3		
	Sub 4		
	Sub 5		
	Sub 6		
	Sub 7		
	Sub 8		
	Sub 9		

## 6 Battery connectivity

The battery has Wi-Fi capabilities that allows it to be monitored remotely and perform OTA remote firmware updates. This setup is optional, and it is required to have a local Wi-Fi connection available to connect to the internet. Follow below instructions if you wish to setup the App and connect battery to the internet:

### 6.1 APP Setup

1. Search for the EndurEnergy App on Google Play Store or App Store: the app name is found as “E2 Smart”.
2. Install the App and create a user and password.
3. Login with your credentials.

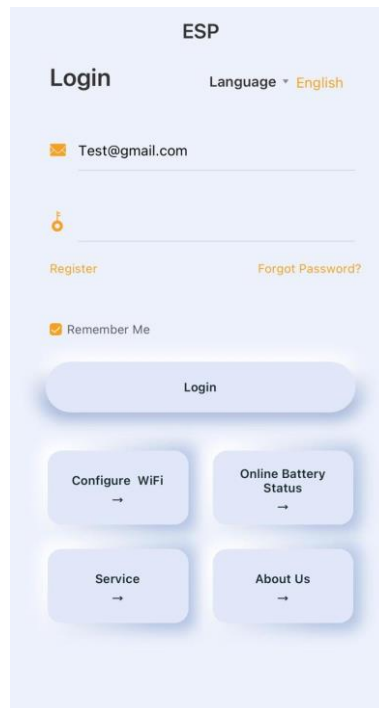

#### 6.1.1 Connect the Battery to the Internet

The battery comes with a built-in Wi-Fi module for use with the App. Follow the instructions to connect the battery to the local Wi-Fi.

1. Turn on the battery you wish to connect to the internet and press the "Reset" button on that battery for 2 seconds. The green light on the battery will start flashing, indicating that it is waiting for a WIFI connection.



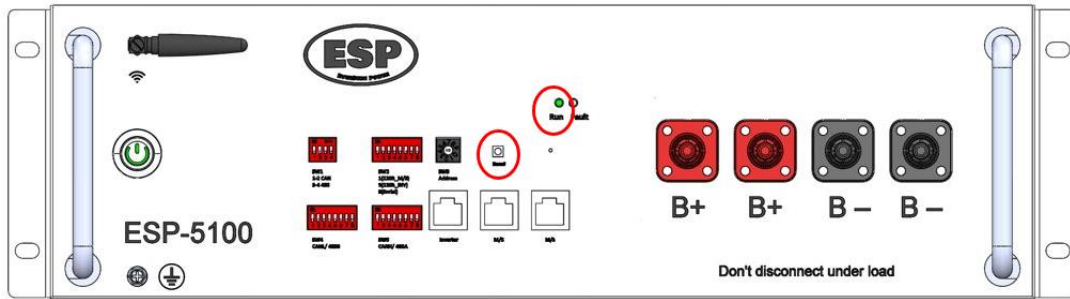

2. Before attempting to connect to the battery make sure your phone is connected to the same local Wi-Fi you wish to connect the battery to. Then go to the App main screen (Logout may be required) and select the 'Configure WIFI' option.

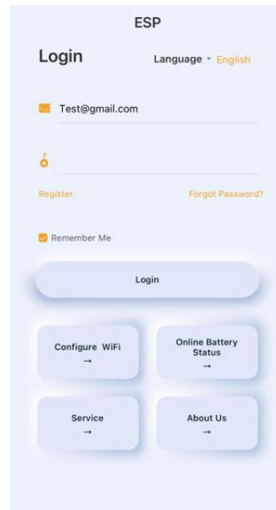

3. Select "ESP-5100" from the menu.



4. Enter your local Wi-Fi name and password on the SSID and password textboxes, then press 'Start'. **DO NOT change the Ap SSID name.**

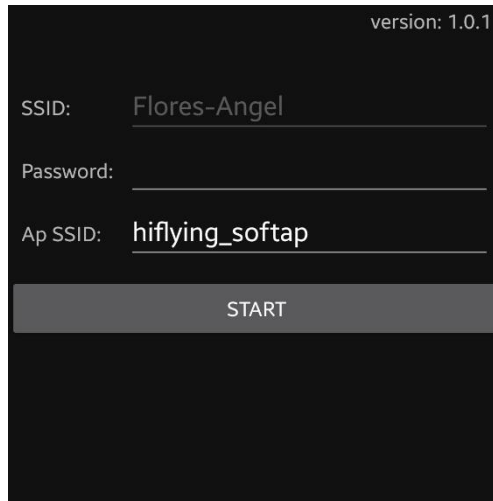

version: 1.0.1

SSID: Flores-Angel

Password: \_\_\_\_\_

Ap SSID: hiflying\_softap

START

5. A window will appear, select the option "GOTO SETUP"

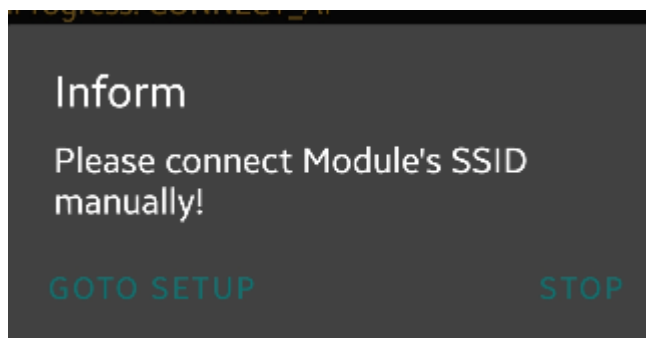

- The App will direct you to your phone Wi-Fi settings then connect your phone to the battery Wi-Fi displayed as “**hiflying\_softap**”. Once your phone connects, go back to the E2 app by using the “Back button” of your phone or swapping between apps.

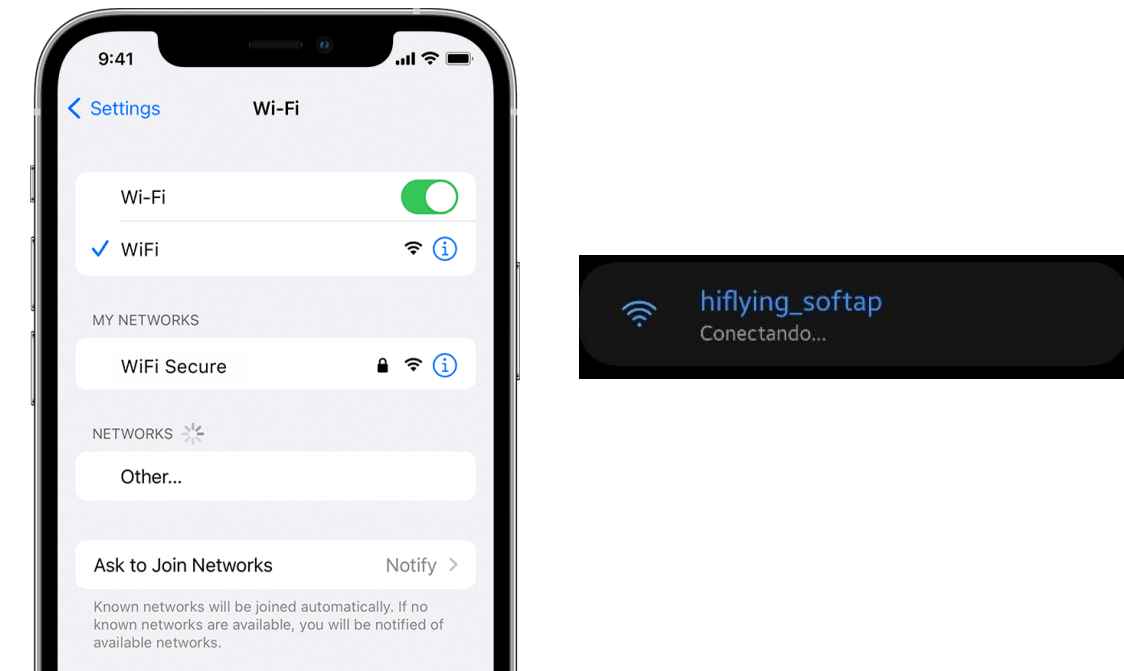

- Wait for the process to finish. The App will start communicating with the battery and it will try to pass the local Wi-Fi credentials to the battery.
- If the connection was successful a confirmation window will appear. If you encounter any issues, press the "Reset" button for 2 seconds and repeat all the above steps.

#### NOTICE

If you are unable to set up the WIFI the battery will still operate normally, however, it is strongly recommended to connect the battery for remote troubleshooting and update firmware.

If still not able to connect please contact us at [support@endureenergy.com](mailto:support@endureenergy.com)

### 6.1.2 Visualize Battery Data from the App

1. Once the battery is connected to the internet via Wi-Fi, you should be able to see the battery parameters, but first you must ensure to link the battery to your account.
2. Enter E2 App and sign in with your account credentials.
3. Select Enable Remote Viewing/Editing.

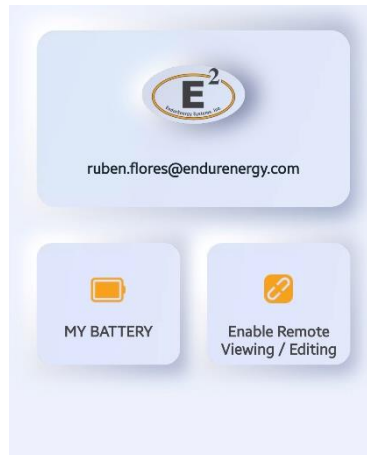

4. Scan or manually input the serial number of the battery you wish to monitor.
5. Add the battery under “MY BATTERY” section.
6. You should be able to see the parameters of that battery by selecting the serial number.

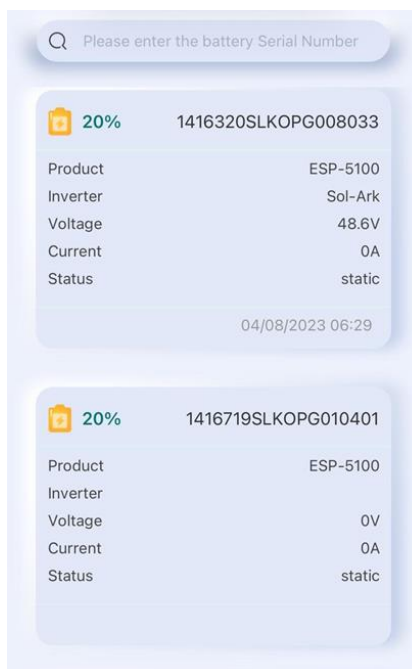

## 7 Commissioning

### 7.1 Commissioning Battery

#### NOTICE

The battery is designed to work on a close loop environment for communicating with the inverter / PCS (check inverter compatibility list), for open loop type of applications we do not ensure proper operation. Contact us if you wish to do an open loop connection.

1. Validate voltage of each battery pack before connecting anything:
  - Press and hold the power button for 4 seconds until the “Run” indicator light turns on.
  - If the voltage is  $\leq 48V$  do not use that battery and contact support for assistance.
  - Record the voltage for that battery.
  - Repeat for all batteries.
  - Comparing all the measured voltages of the batteries, the maximum voltage difference between batteries should be less than 2V. If not, contact support for assistance.
2. Do all the cable connections, make sure to do the proper grounding, power cable (parallel connection) and communication cables, follow instructions as per previous sections.
3. Set the DIP switches according to your battery setup by following instructions on [Section 5.5](#).
4. Follow all the inverter manual considerations prior to energizing the system. The inverter must be off before energizing the batteries.
5. Turn on the batteries by pressing and holding the power button for 4 seconds for each battery.
6. Turn on the inverter and wait for the startup sequence to complete fully. Make sure all the batteries have the green “run” light on and no faults are present after a few minutes.
7. Follow inverter setup and manual. Contact inverter technical support if required to achieve the desired operation, in some cases a firmware update is required.

## 7.2 Shutting Down Battery

WARNING
Shut down the battery only when it is not charging or discharging or connected to any loads. Make sure the Inverter is off or disconnected.

1. Turn off the main battery DC Breaker to the “OFF” position (this breaker is located on the inverter or may have added externally).
2. Press and hold the power button for 5 seconds, then release it after hearing the relay breaking.
3. Make sure that all lights on the battery are off.

## 7.3 Battery charger parameters

Follow the next table for setting values of the battery/inverter charger:

ESP-5100 recommended Charger parameters	
Max A. Charge Current	#ofBatteriesinParallel X 50A**
Max A. Discharge Current	#ofBatteriesinParallel X 50A**
Float Voltage	54.4 V
Absorption Voltage	55 V
Equalization Voltage	55 V
ShutDown Battery	10-20%
Low Battery	35%
Restart Battery	50%

\*\*Example, if your system is composed of 4 batteries in parallel the value will be  $4 \times 50A = 200A$ .

## 8 Firmware Update & Troubleshooting

If there is a persistent fault indicator in one or all the batteries, review the connections and dip switch settings again as well as the inverter connections and settings. If the problem persists and you require further assistance, please contact us ([see Section 1.7](#)).

If you need to upgrade the battery firmware version, please contact us ([see Section 1.7](#)).

For any open loop application, you must contact us to ensure appropriate settings are made.