



EndurEnergy Systems, Inc.



ESP-5K HL

Residential & Commercial ESS Manual



EndurEnergy Systems, Inc.



About this manual

This manual is intended for the ESP-5K HL Lithium Iron Phosphate (LiFePo₄) Battery. These batteries can be installed in parallel and series configurations. Please pay close attention to the DIP switch setting, address selection and cable connections.

Statement

This product is compliant with the Best Practice Guide for Battery Storage Equipment—Electrical Safety, version 1. It meets the mandatory requirements of Method 1 for pre-assembled integrated battery energy storage system equipment, as well as the optional requirements listed under points a), c), e), f), g), h), i), j), k), l), m), n), o), p), and q).

Declaration

EndurEnergy declares that the ESP-5K HL is compliant with the essential requirements and other relevant standards of UL/CE.

Disclaimer

EndurEnergy cannot be responsible for system failure, damage, or injury resulting from improper installation of their products. The information included in this manual is subject to change without notice.

CONTENT

1	Safety Introduction	1
1.1	Important Safety Instructions	1
1.2	Warnings in this Document.....	1
1.3	Battery Handling Guide	2
1.4	Response to Emergency Situations	2
1.4.1	Accidental release measures	2
1.4.2	Fire	3
1.4.3	Wet battery.....	3
1.4.4	Damaged Battery	3
1.5	Installers	4
1.6	Disposing Batteries.....	4
1.7	Contact Information	4
2	Guidance for Disconnection of Batteries During Shipment.....	4
3	Product Introduction	6
3.1	Technical Specifications	6
3.2	Indicators and Ports.....	7
3.2.1	Indicators	7
3.2.2	Ports.....	7
3.2.3	Communication Interface	8
3.3	Typical Battery application.....	9
3.4	Feature	11
4	Installation Prerequisites	11
4.1	Installation Process	11
4.2	Installation Location	12
4.3	Tools	12
4.4	Personal protective equipment (PPE)	13
4.5	Storage.....	13
5	Battery Installation.....	14
5.1	Package Items	14
5.2	Before Installation.....	14
5.3	Battery Mounting.....	15
5.3.1	Rack Mounting (R6 / R12)	15
5.3.2	Enclosure Mounting - (BU10/15/20/30)	18
5.4	Cable Connections of the Battery	21
5.4.1	Battery Grounding	22
5.4.2	Series Connection (High Voltage application)	23
5.4.3	Parallel Connection (Low Voltage application)	25
5.4.4	Communication Cables	27
5.5	Battery DIP Switch Setting	30
6	Battery connectivity	40



EndurEnergy Systems, Inc.



6.1	APP Setup	40
6.1.1	Connect Battery to Internet - WIFI.....	41
6.1.2	Connect Battery to Internet - Direct connection.....	42
6.1.3	Visualize Battery Data from the App	43
7	Commissioning	44
7.1	Commissioning Battery	44
7.2	Shutting Down Battery.....	45
8	Firmware Update & Troubleshooting.....	45
9	Warranty	45

1 Safety Introduction

1.1 Important Safety Instructions







This manual contains crucial instructions for the **ESP-5K HL Residential and Commercial ESS product**. **It is imperative to follow this manual during installation and use of the product.**

While this product is designed and tested to meet international safety requirements such as UL1973, CE, IEC 62040, and IEC 62619, it is essential to take certain precautions when installing and/or operating any electrical and electronic equipment. To minimize the risk of personal injury and ensure the safe installation and operation of the product, it is crucial to thoroughly read and adhere to all instructions, cautions, and warnings provided in this manual.

WARNING
<p>Failure to follow the instructions or warnings in this document can result in electrical shock, serious injury, or death. Damage to the Battery is also possible, potentially rendering it inoperable.</p> <p>High Life Risk Due to Fire or Electrocution – ONLY qualified personnel should install the ESP-5K-HL.</p>

1.2 Warnings in this Document

A warning indicates a potential hazard to equipment or personnel. It highlights procedures or practices that, if not performed correctly, may result in damage to or destruction of the equipment, other connected equipment, or personal injury.

Symbol	Description
	Caution, risk of electric shock
	Heavy enough may cause severe injury
	Keep the battery away from open flame or ignition sources
	Keep the battery away from children
	Dispose of waste batteries according to local laws and regulations
	Recycling
	Read this manual before installation and operation

For safety reasons, it is the responsibility of installers to thoroughly review the contents of this manual and familiarize themselves with all warnings prior to performing the installation.



1.3 Battery Handling Guide

Please follow the guidelines below to ensure safe handling and usage of the battery pack:

- Use the battery pack only as directed.
- If the battery appears cracked, broken, damaged, or fails to operate, immediately contact EndurEnergy hot line at 1-888-E2-ENDUR (1-888-323-6387).
- Do not attempt to open, disassemble, repair, tamper with, or modify the battery in any way.
- The battery is not suitable for users to handle independently.
- When transporting the battery, handle it with care to protect the battery and its components from damage.
- Avoid subjecting the battery to any strong force or impact.
- Do not insert foreign objects into any part of the battery pack.
- Refrain from using cleaning solvents to clean the battery.
- Never connect the battery directly to a SELV (Separated Extra-Low Voltage) circuit.
- Avoid mechanical or electrical abuse.
- Storage preferably in cool, dry and ventilated area, which is subject to little temperature change. Storage at high temperatures should be avoided.
- Do not place the battery near heating equipment, nor expose to direct sunlight for long periods.

1.4 Response to Emergency Situations

While the ESP-5K HL Residential and Commercial ESS is equipped with multiple safety features to prevent hazards caused by failures, it is important to note that EndurEnergy cannot guarantee absolute safety in uncertain situations.

1.4.1 Accidental release measures

In the event of electrolyte leakage from the battery pack, it is crucial to avoid contact with the leaking gas. If the battery material is released, remove operators from area until fumes dissipate. Provide maximum ventilation to clear out hazardous gases. Wipe it up with a cloth and dispose of it in a plastic bag and put into a steel can. The preferred response is to leave the area and allow the battery to cool and vapors to dissipate. Provide maximum ventilation. Avoid skin and eye contact or inhalation of vapors. Remove spilled liquid with absorbent and incinerate.



EndurEnergy Systems, Inc.



1.4.2 Fire

In the event of a fire, it is important to have an ABC or carbon dioxide extinguisher readily available. Do not use water to extinguish the fire.



WARNING

The battery pack may catch fire when heated above 150°

If a fire breaks out where the battery is installed, please follow these actions:

- Prioritize extinguishing the fire before the battery catches fire if it is safe to do so. Use appropriate fire extinguishing methods and equipment according to the type of fire (e.g., ABC or carbon dioxide extinguisher). Ensure your safety and consider seeking professional assistance if necessary.
- If the battery has already caught fire or if it is not safe to attempt extinguishing the fire, prioritize the immediate evacuation of all individuals from the area. Follow established emergency evacuation procedures and ensure everyone moves to a safe location. Contact the appropriate emergency services to report the fire.

Note: The above actions are intended to address fire situations where the battery is involved. Always prioritize personal safety and adhere to established emergency procedures.

WARNING

If the battery catches fire, it will produce poisonous gases. Do not approach.

1.4.3 Wet battery

If the battery becomes wet or submerged in water, do not attempt to access it. Instead, please contact EndurEnergy Customer Service or reach out to your distributor for immediate technical assistance.

1.4.4 Damaged Battery

If you notice any external or internal damage to the battery, please contact EndurEnergy customer service or your distributor for assistance as soon as possible. It is crucial to handle a damaged battery with extreme caution, as it can be dangerous. A damaged battery is not suitable for use and may pose a risk to people and property. If you suspect the battery is damaged, promptly return it to EndurEnergy or your distributor.

CAUTION

A damaged battery may potentially release electrolyte or flammable gas.



1.5 Installers

It is highly recommended that the installation of the ESP-5K HL Residential and Commercial ESS is carried out by a skilled worker or electrician. A skilled worker is defined as an individual who has received proper training and possesses the necessary qualifications as an electrician, or has acquired the following skills and experience:

- Comprehensive knowledge of the functional principles and operation of on-grid Energy Storage systems.
- Understanding of the potential dangers and risks associated with the installation and use of electrical devices, as well as familiarity with acceptable mitigation methods.
- Proficiency in the installation of electrical devices.
- Familiarity with and adherence to the instructions provided in this manual, including all safety precautions and best practices.

1.6 Disposing Batteries

When dealing with scrap battery(-ies), it is important to comply with local laws and regulations regarding the recycling or disposal of batteries. Please ensure that you follow the appropriate procedures as outlined by your local authorities for recycling or disposing of Lithium Iron Phosphate batteries.

1.7 Contact Information

For technical assistance, please use the contacts provided. Please note that the phone numbers are available for assistance during business hours on weekdays.

Customer careline	1-888-E2-ENDUR (1-888-323-6387)
Email	support@endurenergy.com

2 Guidance for Disconnection of Batteries During Shipment

- The ESP-5K HL is not suitable for air transport.
- Cartons that have been crushed, punctured, or torn in such a way that the contents are revealed shall be set aside in an isolated area and inspected by a skilled person. If the



EndurEnergy Systems, Inc.



package is deemed to be non-shippable, the contents shall be promptly collected, segregated, and either the consignor or consignee should be contacted.

- The DC circuit of the ESP-5K HL battery has been disconnected and turned off prior to shipping.
- We have conducted comprehensive tests to ensure that the equipment distributed worldwide is safe for shipping. These products should be handled with care and immediately inspected if visibly damaged. If the carton is visibly damaged, please contact EndurEnergy customer service to confirm whether the battery can be used safely or not.



EndurEnergy Systems, Inc.



3 Product Introduction

3.1 Technical Specifications

Product Type	ESP-5K HL
Total Energy*	5.00 kWh
Usable Energy (DC)*	5.00 kWh
Nominal Voltage	51.2 VDC
Max. Continuous Discharge/Charge Power	3.0 kW
Peak Power (Only Discharge)	5 kW for 3s
Operation Voltage	48~57.6 VDC
Maximum Discharge Current	60A
Maximum Charge Current	60A
Maximum Charge Voltage	57.6 VDC
Weight	46 kg 101.41 lb
Dimensions	442 x 500 x 133 mm 17.4 x 19.7 x 5.2 inch
Max. Recommended Depth of Discharge (DOD)	90%
Operating Condition	Indoor use
Charge Temperature Range	0 to 50 °C (32 to 122 °F)
Discharge Temperature Range	-10 to 55 °C (14 to 131 °F)
WIFI Frequency Range	2400 MHz-2483 MHz
Humidity Limit	<60% (no condensed water)
Over Voltage Category	II
Cooling Type	Natural cooling
Case Material	Steel
Color	White
Installation	Wall Mounting/Ground Installation
IP Rating	IP 20
Protective Class	I
Max. Number of Parallel Connections	16S/16P
Warranty	10-Year
Lifespan	> 15 years
Communication Protocols	CAN/ RS485
Protection Mode	Dual hardware protection
Battery Protection	Over-current/Over-voltage/Short circuit/ Under-voltage/Over temperature
Safety Certificate	UL1973, UL9540a, UL9540
Hazardous Material Classification	9
Transportation	UN 38.3

*Testing conditions based on temperature 25 °C at the beginning of life.

*Total Energy/Usable Energy measured under specific conditions from ESP 0.2C CC-CV.

3.2 Indicators and Ports

3.2.1 Indicators

There are two LED indicators on the front of the battery that show its operating status.

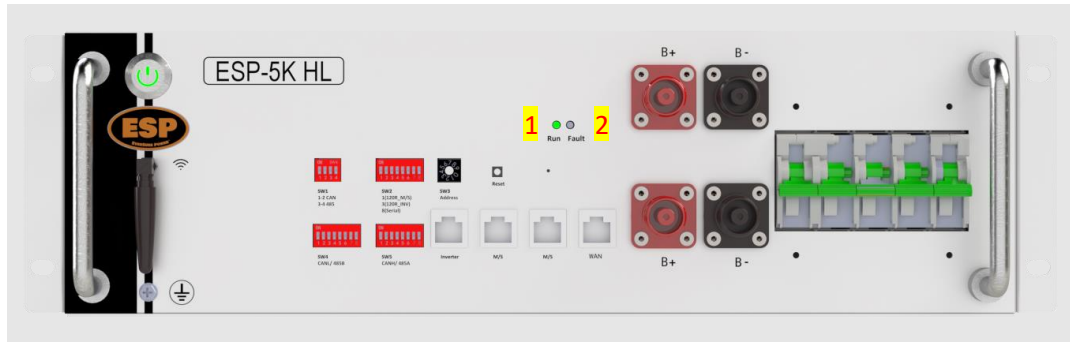

Item	Designation	Definition
1	Run	Steady: The battery is working normally. Blinking: Reset Button pressed, expecting Wifi connection from App.
2	Fault	There are failures or issues with the battery. See troubleshooting or contact EndurEnergy Tech Support.

3.2.2 Ports

The power cable interface and the communication cable interface are shown in the following image. **The DC Breaker comes with a cover for shipping, make sure to remove it by unscrewing the 4 cover screws after unpacking the battery.**

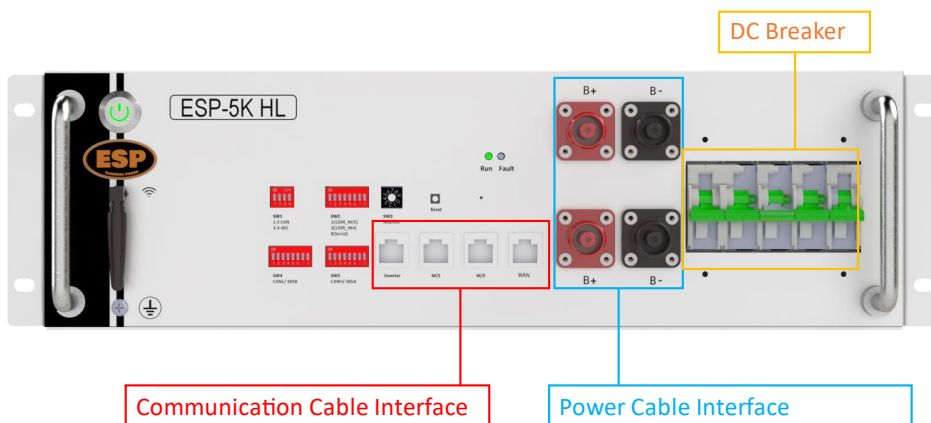

3.2.3 Communication Interface

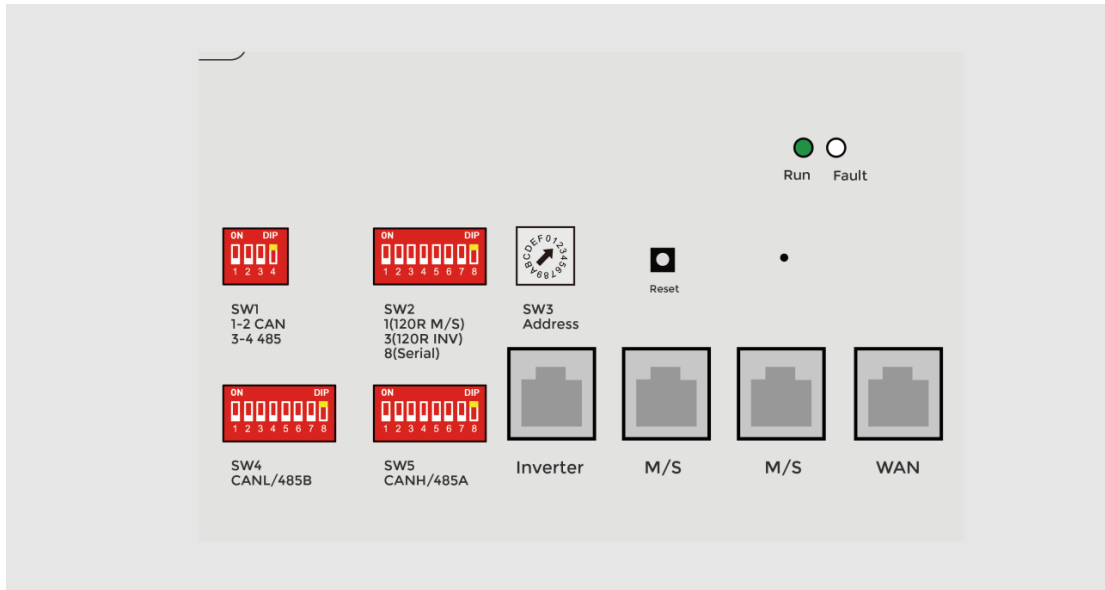

Note: For switches: SW1, SW2, SW4 and SW5; the “ON” position means the number is on the upper side.

Designation	Definition
SW 1	The DIP switch is used to select the communication mode between CAN and RS485. Please refer to the inverter's user manual for detailed instructions. <ul style="list-style-type: none"> For CAN Communication, set SW1 to positions 1 and 2 “ON”. For RS485 Communication, set SW1 to positions 3 and 4 “ON”.
SW 2	The communication resistance and DIP switch settings for parallel or series connections. (See Section 5.5)
SW 3	Used for setting the battery address in a multiple battery system setup. (See Section 5.5)
SW 4	Used for communication between the primary battery and the inverter. <ul style="list-style-type: none"> Factory standard setting: position 5 “ON”.
SW 5	Used for communication between the primary battery and the inverter. <ul style="list-style-type: none"> Factory standard setting: position 4 “ON”.
Reset	Used to reset the Wi-Fi or GPPS/GPS module configuration.
Inverter	Ethernet port used for communication between the primary battery and the inverter.

M/S	Ethernet ports used for communication between batteries.
WAN	Ethernet port used for the network interface.
DC Breaker	1000VDC, 75A Breaker internally wired, protects battery pack from an overcurrent or short circuit. The DC Breaker comes with a cover for shipping, make sure to remove it by unscrewing the 4 cover screws after unpacking the battery.

NOTICE

The battery is designed to work on a close loop environment for communicating with a Solark inverter or compatible inverter (check inverter compatibility list), for open loop type of applications we do not ensure proper operation and not encourage it. If you intend to use the battery on an open loop application or not supported inverter, call our technical support.

3.3 Typical Battery application

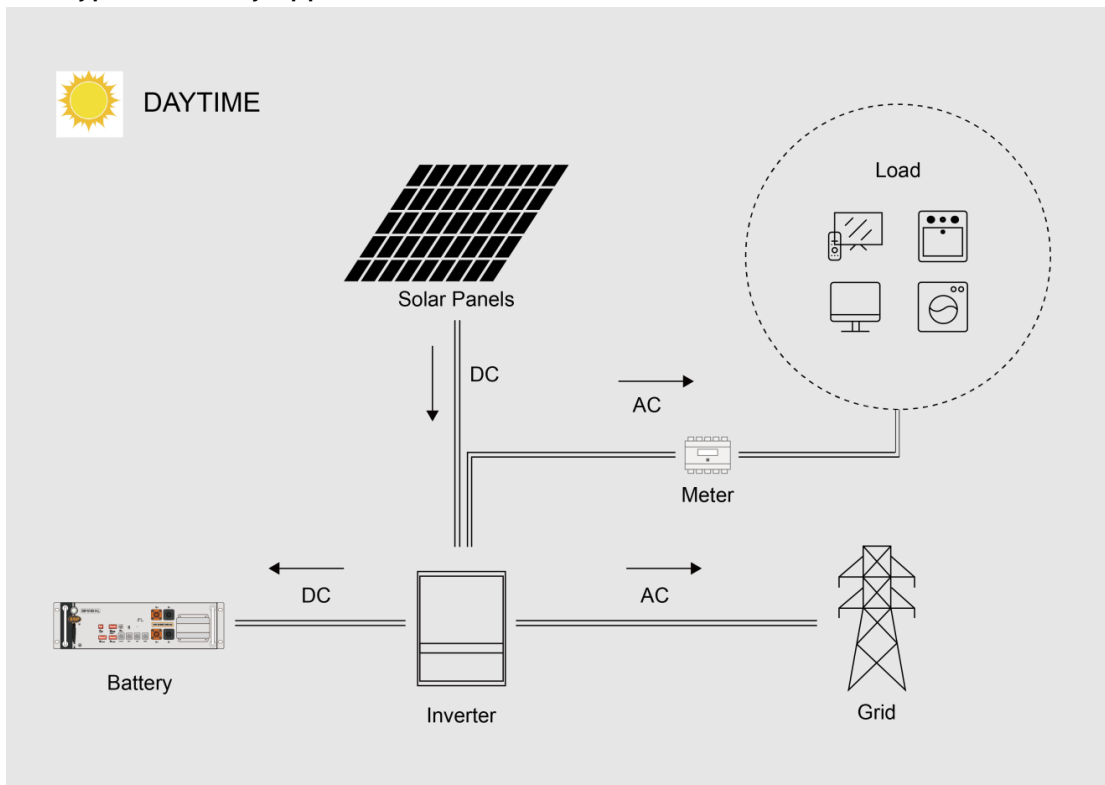



EndurEnergy Systems, Inc.

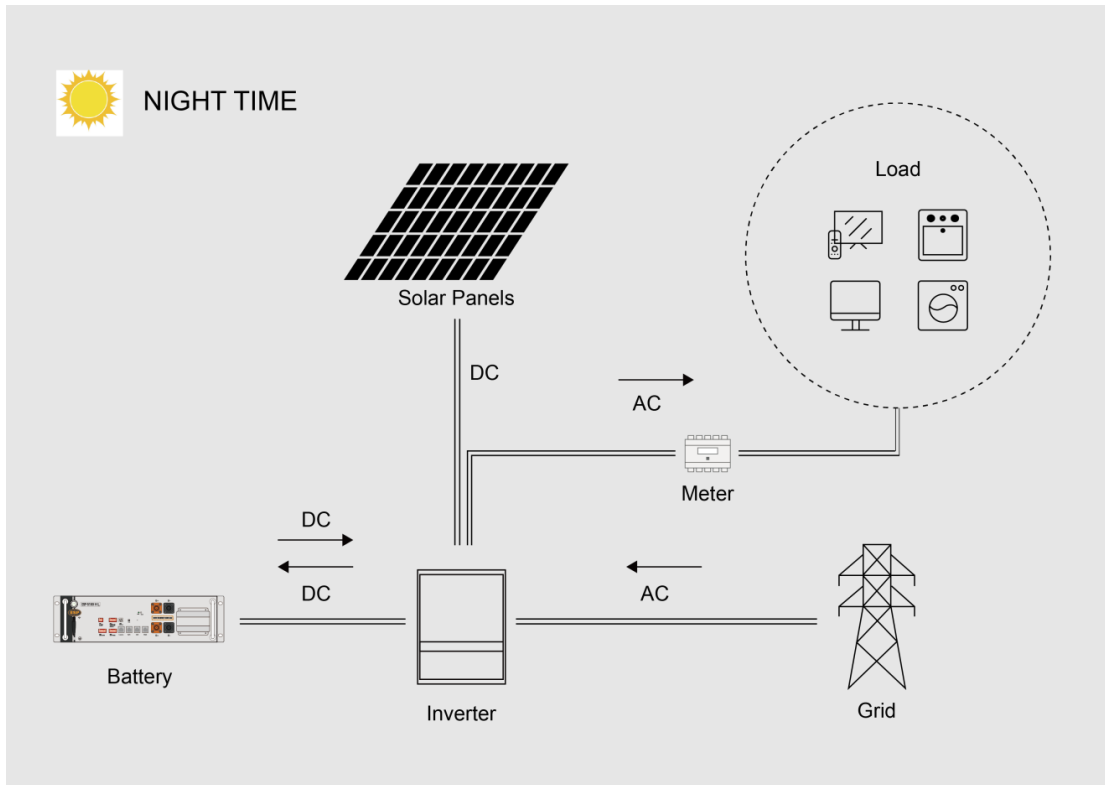

3.4 Feature

The ESP-5K HL battery has the following features:

- **Energy storage unit:** This battery is suitable for compatibility with photovoltaic systems.
- **Battery management system (BMS):** The battery has a built-in BMS that monitors its operation and prevents it from operating outside the design limitations.
- **Monitor:** The battery's built-in BMS is equipped with a WiFi module, allowing users to monitor the battery's operating information on mobile phones and computers.
- **Easy firmware update:** The BMS firmware can be easily updated to the latest version.
- **Expandability:** The battery capacity can be increased by adding another battery.

4 Installation Prerequisites

4.1 Installation Process

The battery should be installed according to the following flowchart. The detailed installation process is described in Section **Battery Installation**.

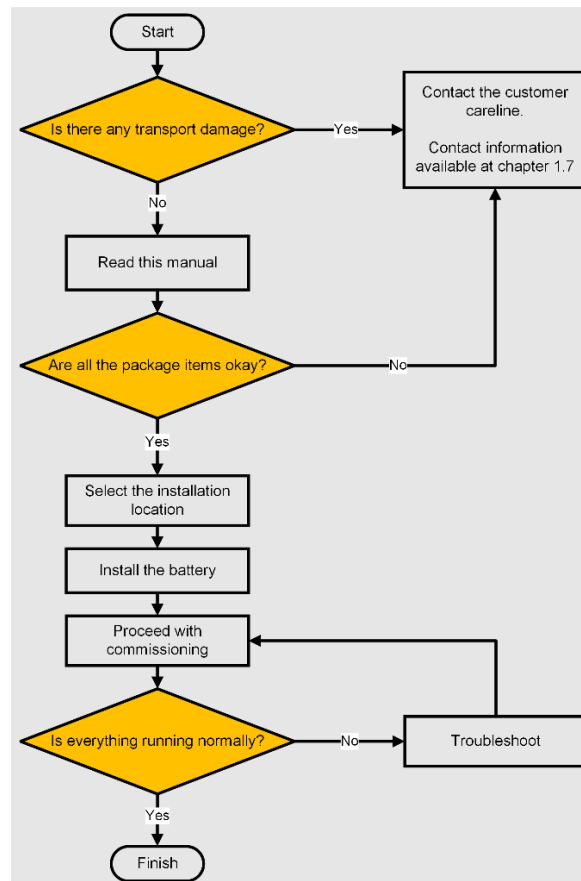

4.2 Installation Location

Ensure that the installation location meets the following conditions:

- The building is designed to withstand earthquakes as per the building code (when applicable).
- It is far away from the sea to avoid saltwater and humidity.
- The floor is flat and level.
- There are no flammable or explosive materials nearby.
- The optimal ambient temperature is between 15°C and 30°C.
- The temperature and humidity remain at a constant level.
- There is minimal dust and dirt in the area.
- There are no corrosive gases present, including ammonia and acid vapor.
- The battery and racks are rated IP20, indicating that they are suitable for indoor use, if required to be placed outside it will require an enclosure or cabinet.

If the ambient temperature is outside the operating range, the battery will protect itself by shutting down. The optimal operating temperature for the battery is 15°C to 30°C. Frequent exposure to severe operating conditions would negatively affect the performance and lifespan of the battery.

4.3 Tools

To install the battery pack, the following tools are required:

			
Flat-head & Phillips Screwdriver	Torque wrench	Cable crimper	Wire clamp
			
Voltmeter	Measuring tape	Drill	Bubble Level

To ensure the safety of the operator and installer, please select and use suitable tools and measuring instruments that are certified for precision and accuracy.

4.4 Personal protective equipment (PPE)

When handling the battery, the following safety gear should be worn. Installers must comply with the relevant requirements of UL1973, IEC 62040, and IEC 62619, or applicable domestic legislation and other relevant international standards.



4.5 Storage

If the battery is not going to be installed immediately and needs to be stored for a long period, please choose an appropriate location for storage. Follow these instructions for storage:



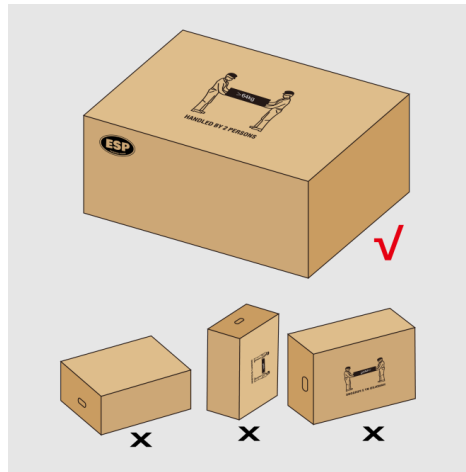

- Do not stack more than four battery boxes.
- The recommended storage temperature for the battery is in the range of -20°C to 30°C.
- Avoid exposing the battery to water.
- If the battery needs to be stored for over 3 months, it will discharge at a minimum rate and the capacity may degrade depending on the storage time.
- If the battery is stored for over 6 months, it is recommended to connect the battery with the inverter and commission the system.
- The battery boxes should be stored upright as shown in the following figure and should not be stacked upside down.



5 Battery Installation

5.1 Package Items

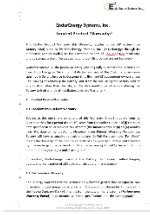
You will receive one packing carton containing the batteries. The items included are summarized as follows:

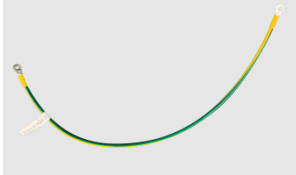
	 <p>ESP-5K HL Residential ESS Manual</p>	
<p>1 x ESP-5K HL</p>	<p>1 x User Manual</p>	<p>1 x Warranty Letter</p>
		
<p>1 x Communication Cable</p>	<p>1 x Power Cables</p>	<p>1 x Grounding Wire</p>

Note: Product accessories are customized according to customer needs. This list represents only the standard accessories. Endur does not provide cables for all situations, for special projects ask sales team.

5.2 Before Installation

There are a few things to check before installing the battery to ensure that it is free of defects.

Check the battery voltage using the following instructions:

- Press and hold the panel button for 4 seconds and release it when two indicators turn on.
- Measure the voltage at the terminal interface using a voltmeter. If the voltage is lower than 48V, do not use the battery and contact customer service.
- Turn off the battery after checking voltage.

5.3 Battery Mounting

The ESP-5K-HL is designed as a rack mount type battery, this adds flexibility on installation and modularity for different configurations. We offer different rack and enclosure solutions for our batteries, see instructions below.

5.3.1 Rack Mounting (R6 / R12)

1. Place the Rack in the location desired (refer to the details about the installation location described in [Chapter 4.2](#)). The enclosure should be moved close to its installation location inside its shipping container before it is unpacked. The enclosure must be installed in a structurally sound area with a level floor that is able to bear the weight of the rack + the intended number of batteries to be installed inside.

CAUTION

Our rack solutions are designed for indoor installations IP20/NEMA1.
if the batteries are intended to be used outdoors, a cabinet / enclosure is required.

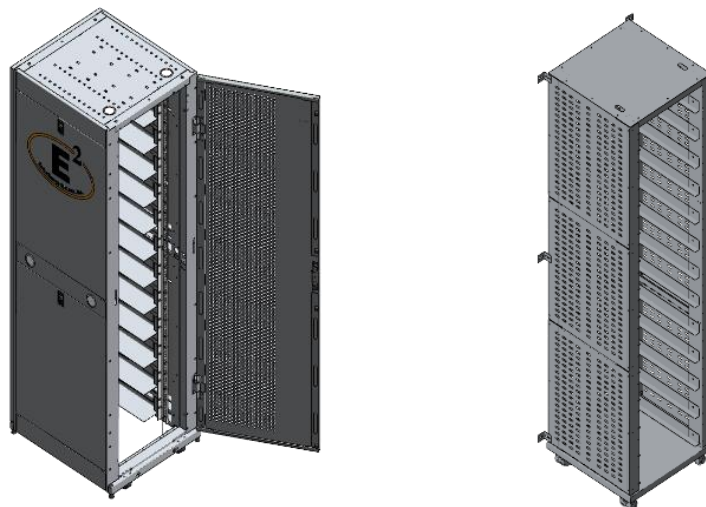

2. Adjust leveler feet (if included), lower each leveler unit it reaches the floor, make sure each leveler contacts the floor solidly. After lowering each leveler, use the carpenter's level / bubble level to confirm that the rack is level. Adjust levelers as needed to get level.

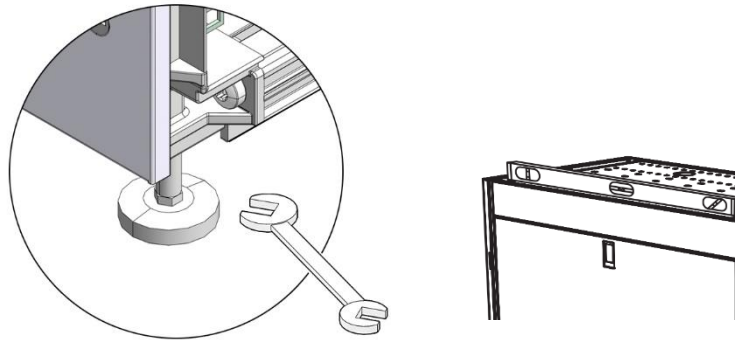

3. In order to secure the rack to the building structure for stability, attach the provided brackets to the wall or to the floor (depending on the rack model) using adequate screws. Verify foundation for seismic installations.

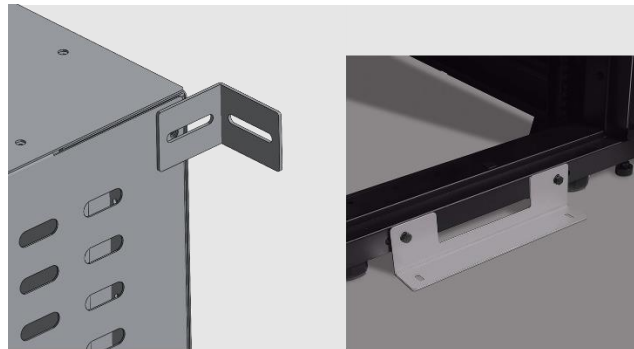

4. Slide in each battery into the horizontal brackets of the rack, each battery must be spaced out vertically 1/3 U (0.583" / 14.82 mm) to ensure heating dissipation. Use M6 screws to secure the batteries in place to cage nuts, max torque of 8.7 lb*ft. If Rack does not have cage nuts, use the appropriate screws to fix into the predrilled holes.

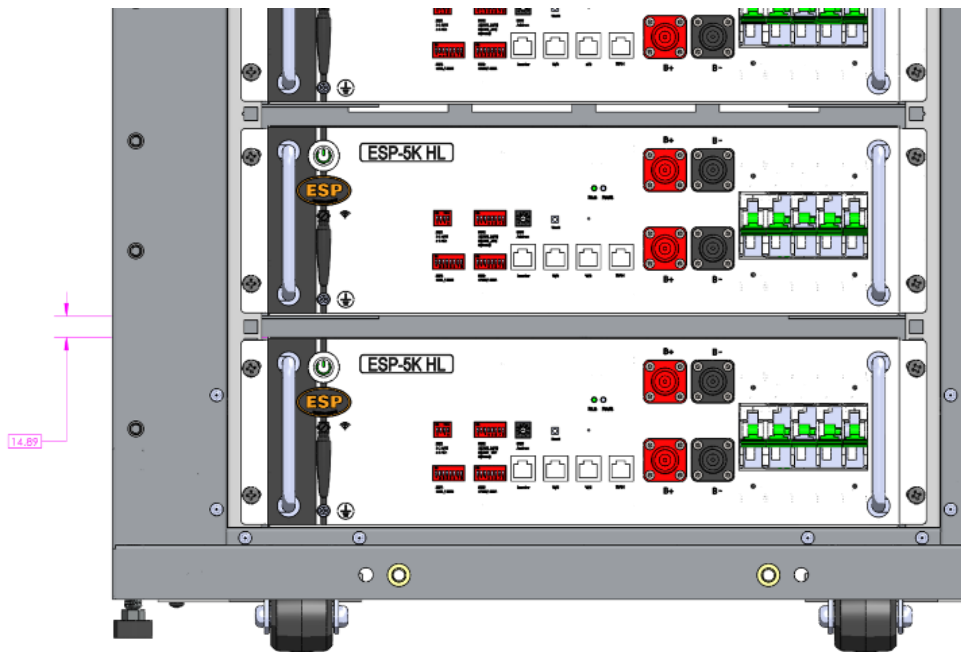
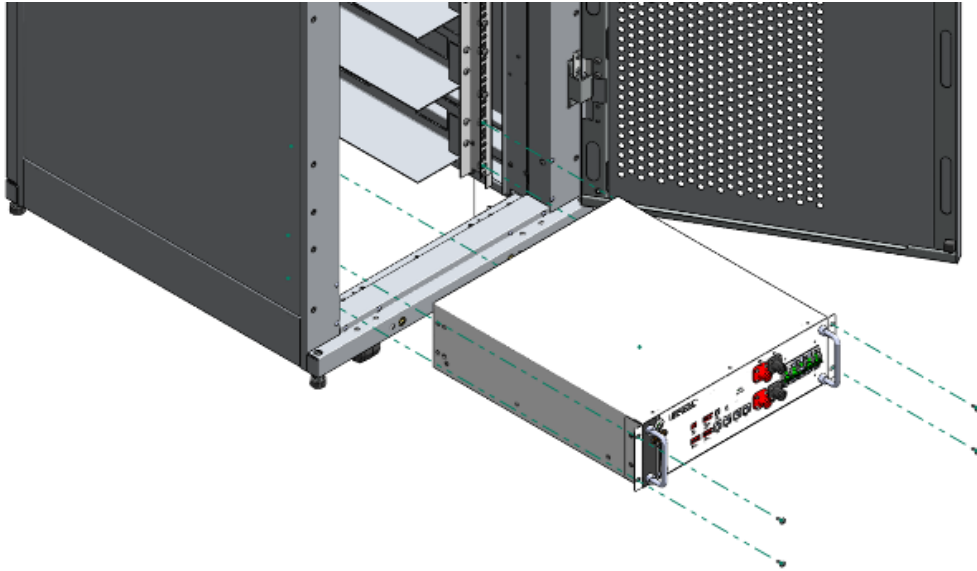



EndurEnergy Systems, Inc.



5.3.2 Enclosure Mounting - (BU10/15/20/30)

1. Place the enclosure in the location desired (refer to the details about the installation location described in [Chapter 4.2](#)). The enclosure should be moved close to its installation location inside its shipping container before it is unpacked. The enclosure must be installed in a structurally sound area with a level floor that is able to bear the weight of the enclosure + the intended number of batteries to be installed inside.

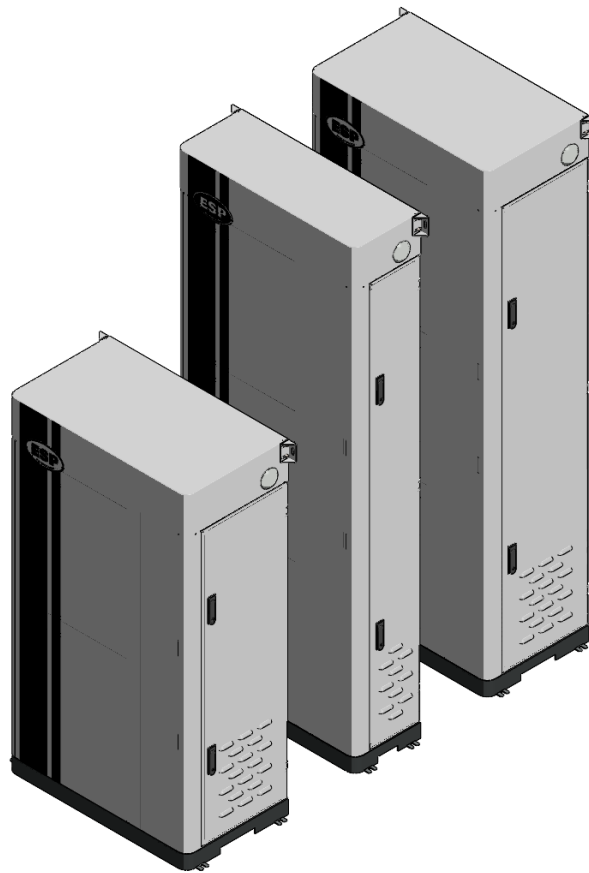

NOTICE

Our enclosure solutions are designed for outdoor installations rated IP55 / NEMA 3R.

2. In order to secure the enclosure to the building structure for stability, adjust the 2x wall brackets by losing the screws, move the brackets to leave a gap of at least 0.5" between the wall and the enclosure to allow airflow and door opening. Tighten the screw brackets and attach both brackets to the wall with 2x adequate screws (M8 or 5/16").

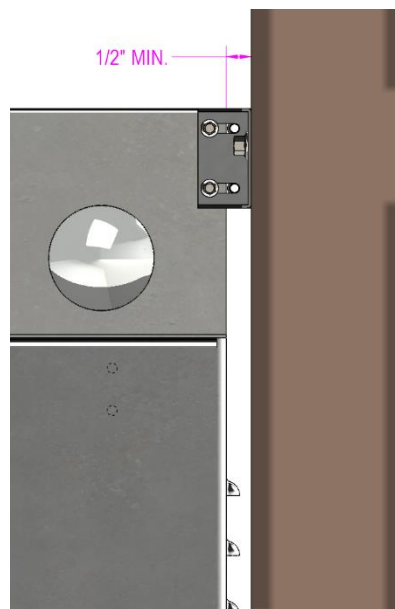
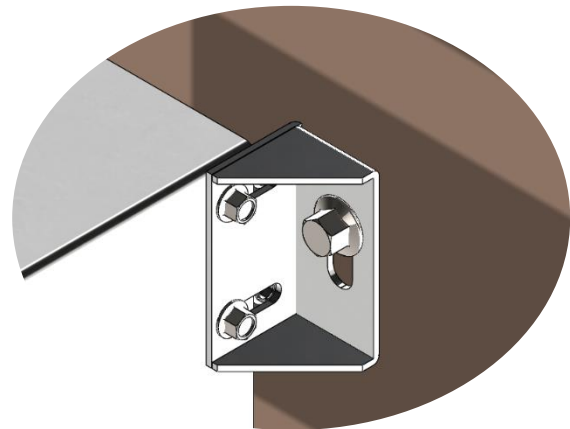
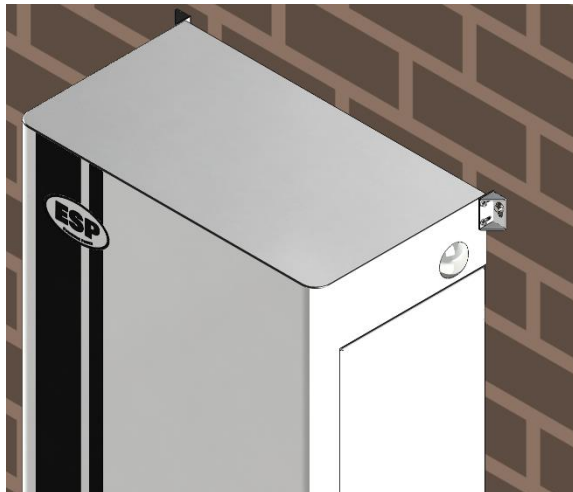

3. Fix the enclosure to the floor by using 4x adequate screws (M8 or 5/16"). Verify foundation for seismic installations.

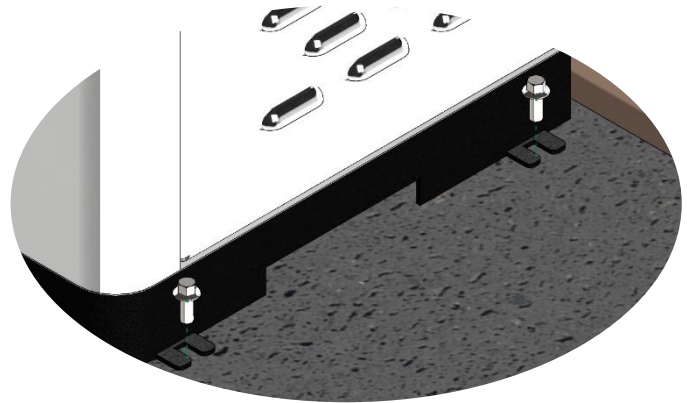
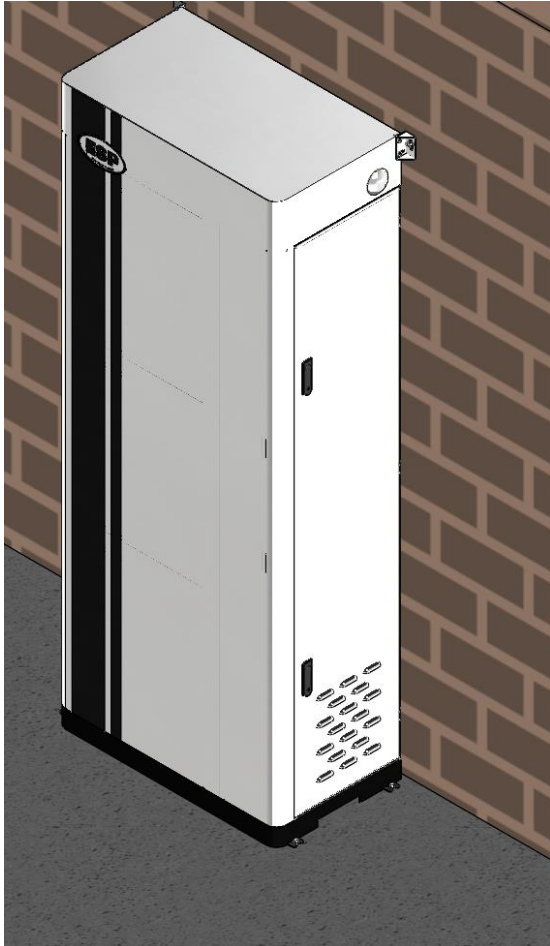

- Slide in each battery into the enclosure, the battery enters vertically. Use M6 screws to fix into the predrilled holes and secure the batteries in place, max torque of 8.7 lb*ft.

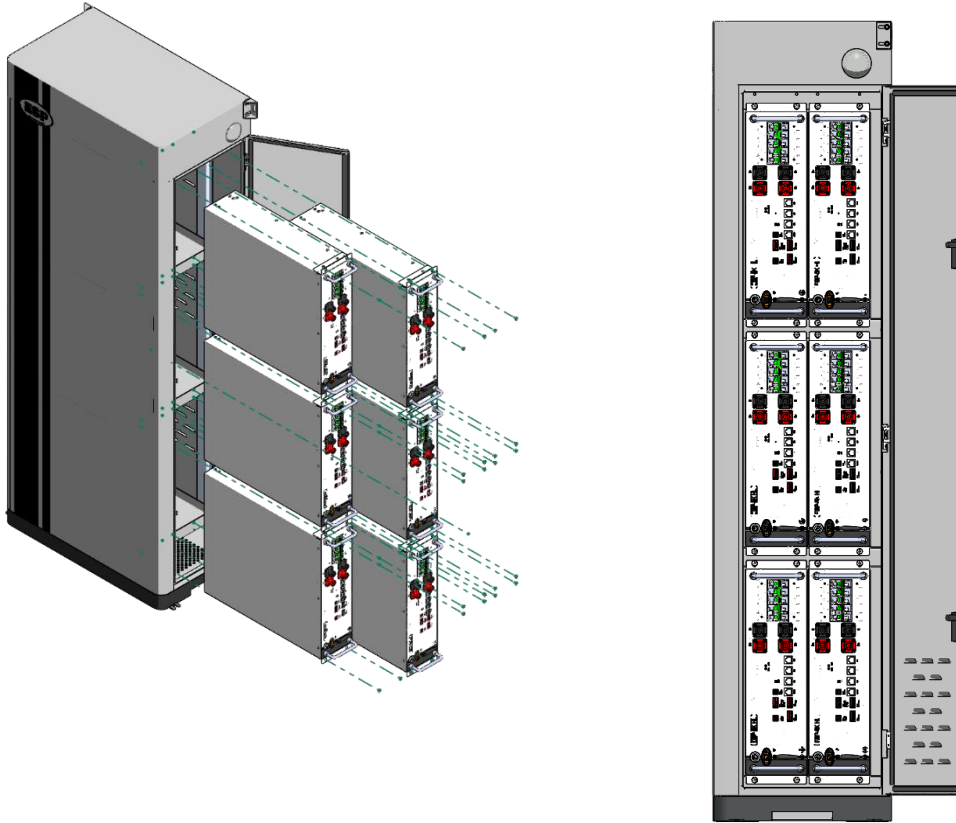

5.4 Cable Connections of the Battery

WARNING

Connect the cables in accordance with local installation laws and regulations. Before connecting the cables, ensure that the battery is turned OFF. Also, make sure to turn off the DC breaker of each battery. Failure to do so may result in electric shocks due to the high voltage of the battery.

Make sure the cap is on if you don't need to use the power interface.

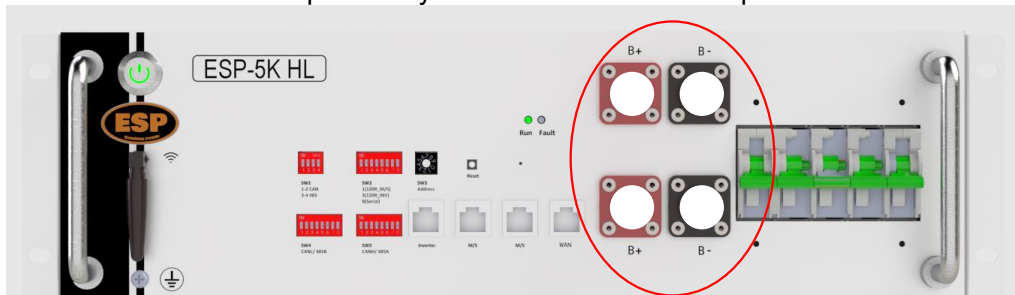

5.4.1 Battery Grounding

There is a grounding icon on the front of the battery that indicates the grounding screw of the battery, connect the grounding wire on this screw and make sure all the batteries grounds are interconnected, this ground shall also be connected to the bonding ground of the inverter or PCS where the batteries will be installed, the ground bonding system shall be installed as per NEC Article 250 or local regulations.

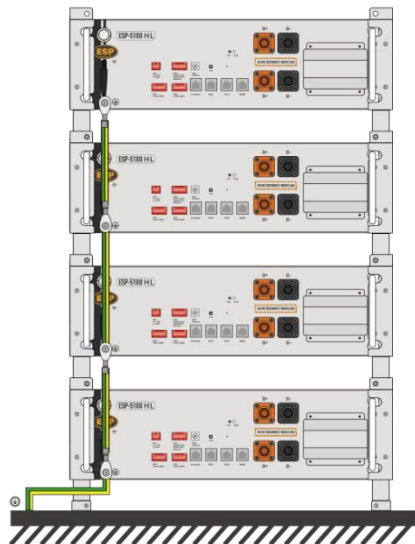
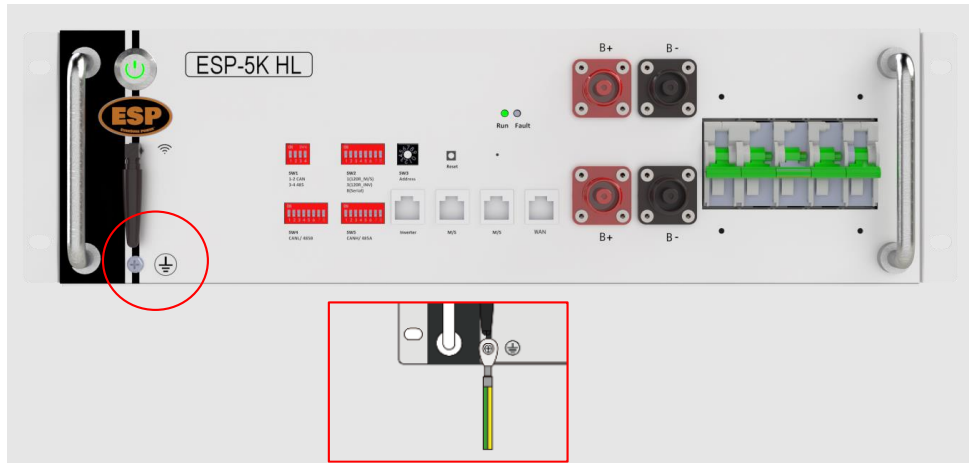

5.4.2 Series Connection (High Voltage application)

WARNING

When doing a series connection, the voltage of the system will increase for each battery added, voltage can reach up to 1000 V in some applications, have extra cautions when cabling this configuration, always turn off all the system when doing any cabling connection.

Make sure the inverter/PCS used for the system supports a high DC voltage application.

NOTICE

Before installing two or more batteries in series, please check the voltage of each battery and ensure that the voltage is the same or between $\pm 0.5V$.

A series connection for 3 batteries is shown in the below schematic, the positive terminal of 1 battery connects to the negative terminal of the following battery, the first battery starting the circuit (bottom) will have the main negative terminal of the full system (B-) and the last one in the circuit (top) will have the main positive terminal (B+). The circuit shown below will have a nominal DC voltage of around 150VDC (3 Batteries* 50V) and a max. charge/discharge current of 50A, this circuit is also called a string.

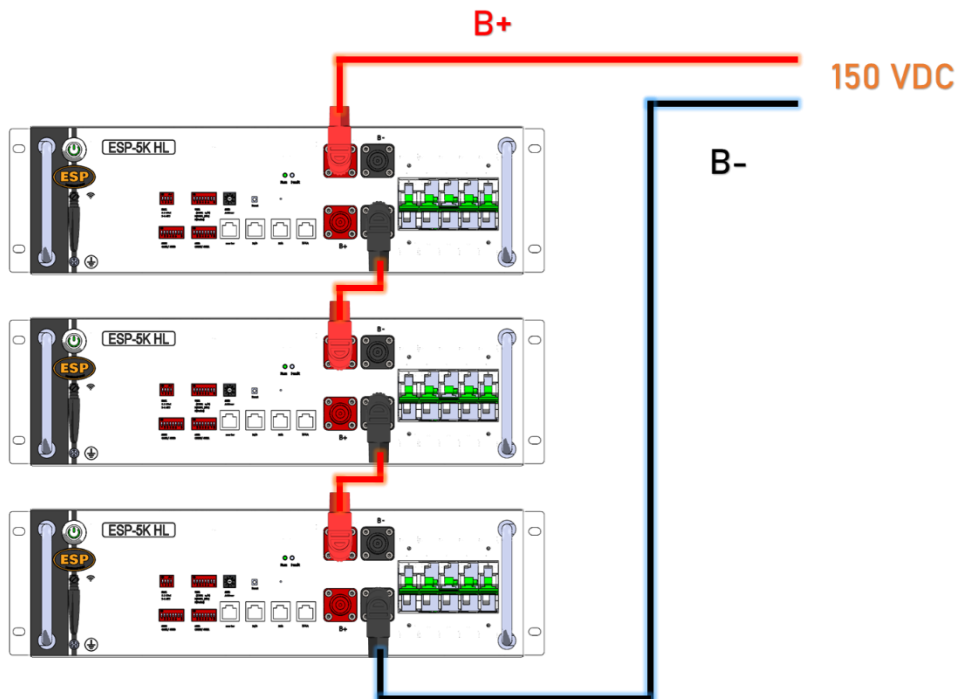

The main negative and positive terminal of the string will connect to the battery input of the inverter or PCS.

Following this principle, wire the # batteries in series required for the circuit in order to obtain the voltage required for the Inverter, use the series cable provided (short cable with Amphenol terminals on both sides).

WARNING

Do not connect more than 16 batteries in series.
Cables and circuits have a max rate of 1000 VDC, and dip switches will not allow this configuration.

NOTICE

If you add more strings in parallel and want to connect to that same input, an ESP-BCU-HL can be added, the BCU setup is not part of the scope of this manual, refer to ESP-BCU HL Manual for setting up multiple strings in parallel.
It is also recommended to add an appropriate circuit breaker for the system when multiple strings in parallel are used (not supplied by Endur).

5.4.2.1 Series connection example: 1 string of 6*ESP-5K-HL to a SA-30K inverter

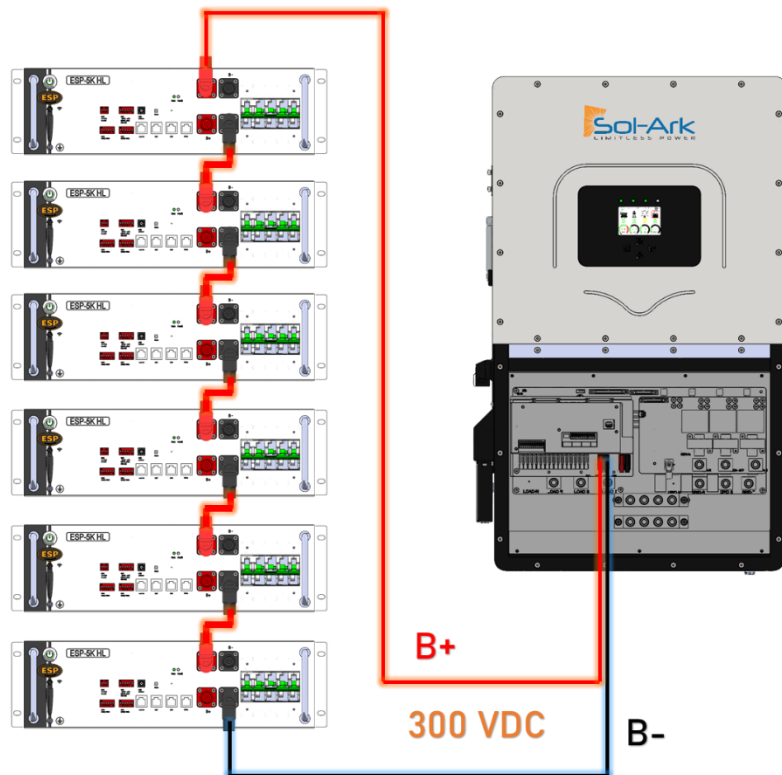

WARNING

Always follow Inverter's installation manual prior to making any connection.
This manual does not substitute inverter manual.

5.4.3 Parallel Connection (Low Voltage application)

NOTICE

Before two or more batteries are connected in parallel, please check the voltage of each battery and make sure the voltage difference is less than 2.0V.

A parallel connection for 3 batteries is shown in the below schematic, the positive terminal of all batteries is commonly wired, the same will be to the negative terminal, the main negative terminal of the full system (B-) is common negative and the main positive terminal (B+) is a common positive. The circuit shown below will have a nominal DC voltage of around 50VDC and a max. and a charge/discharge current of 150A; this circuit is also called a string.

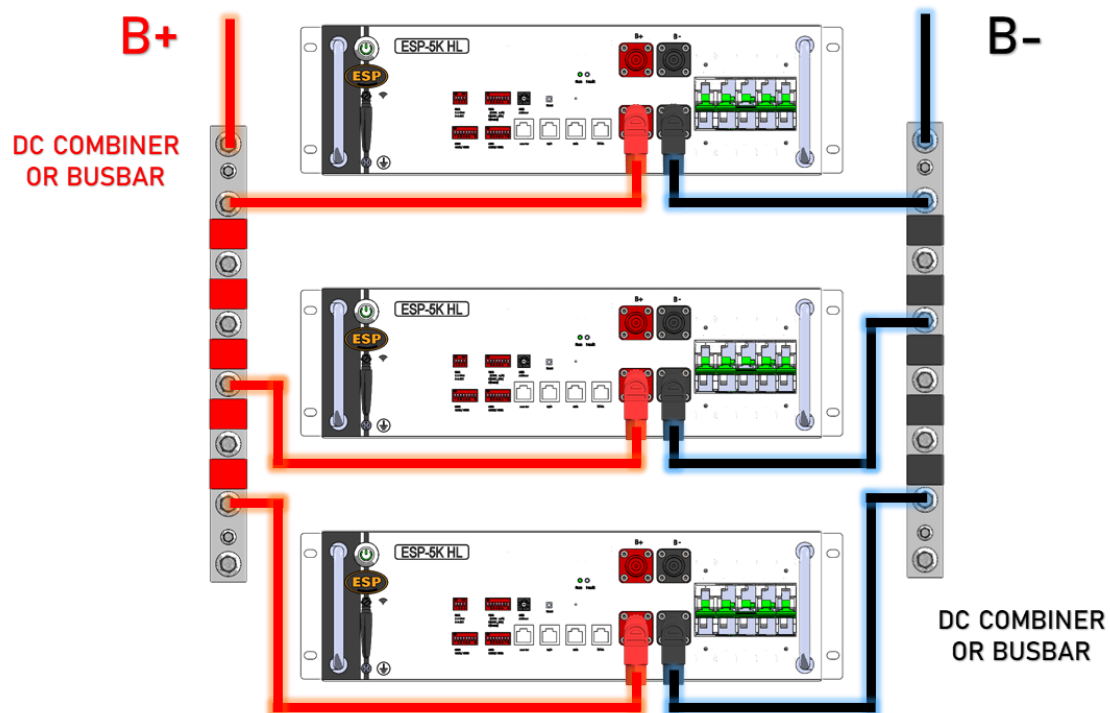

The main negative and positive terminal of the string will connect to the battery input of the inverter or PCS.



EndurEnergy Systems, Inc.



NOTICE

ESP-5K-HL includes a breaker in each battery, however, if you add more strings in parallel and want to connect to that same input, it is recommended to add an appropriate circuit breaker for the system (not supplied by Endur).

The maximum possible ESP-5K-HL to put in parallel is 16 (80KWh), if the system requires more batteries in parallel an ESP-BCU-HL can be added, the BCU setup is not part of the scope of this manual, refer to ESP-BCU HL Manual for setting up multiple strings in parallel.

5.4.3.1 Parallel connection example: 1 string of 4*ESP-5K-HL to a SA-12K inverter

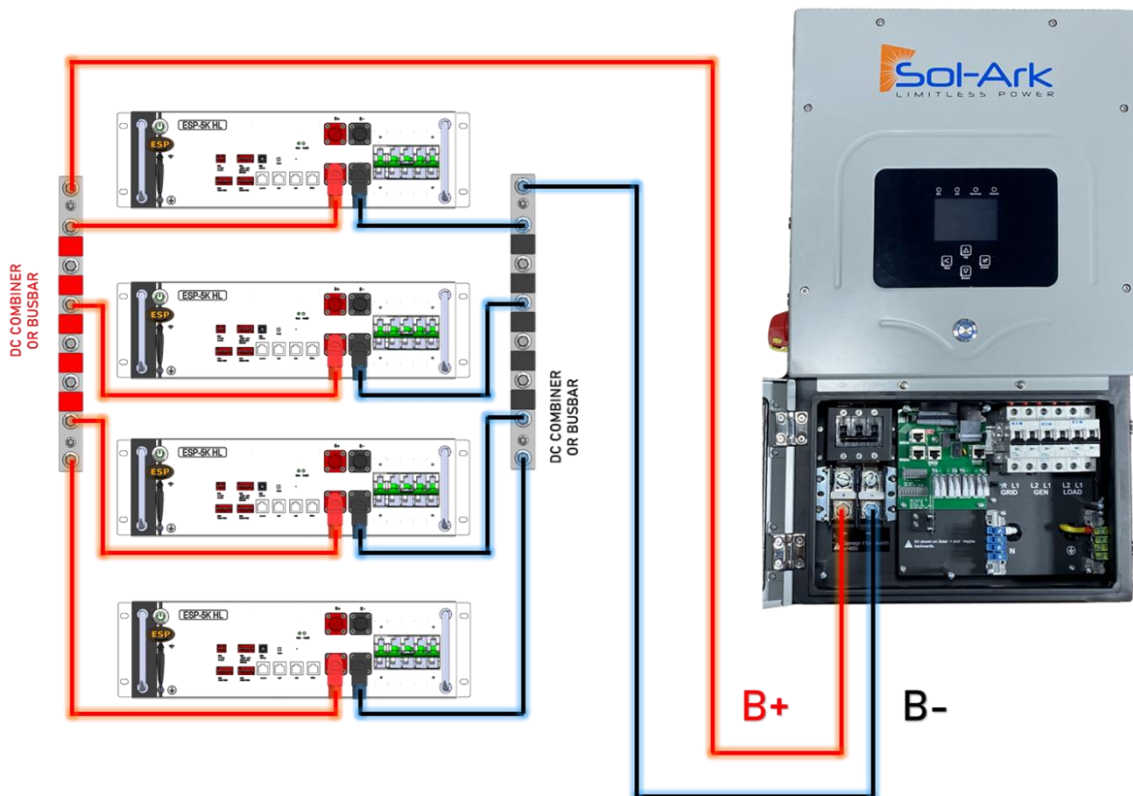

WARNING

Always follow Inverter's installation manual prior to making any connection.
This manual does not substitute inverter manual.

5.4.4 Communication Cables

Each battery includes a BMS (Battery Management System) that allows for communication with compatible inverters, the communication is done through an ethernet cable UTP CAT6 with RJ45 connector, it accepts RS485 and CAN BUS.

There are no special cable requirements for the wiring of these ethernet cables as long as all cables are wired the same, standard T-568B is recommended.

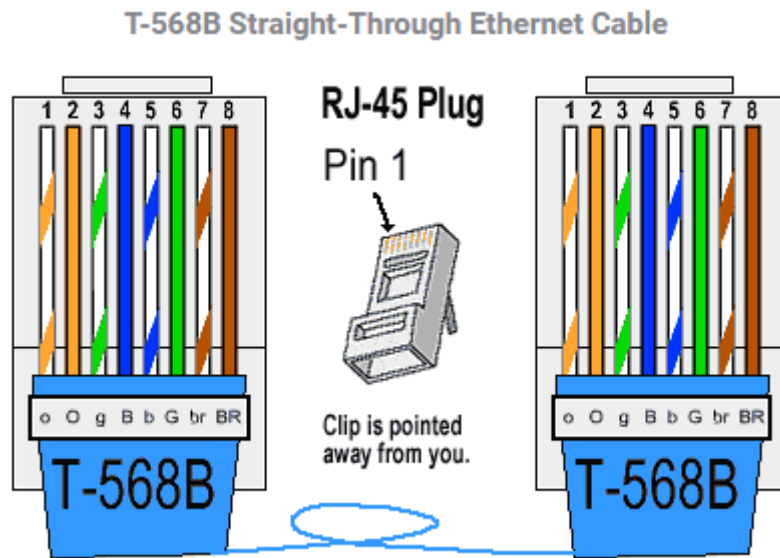

5.4.4.1 Connecting Batteries for communication

When connecting a string of batteries (either series or parallel) all the batteries of that string must have communication between each other using a communication cable connected between their M/S Port.

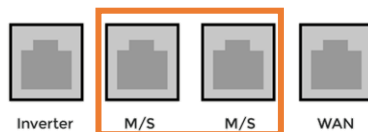
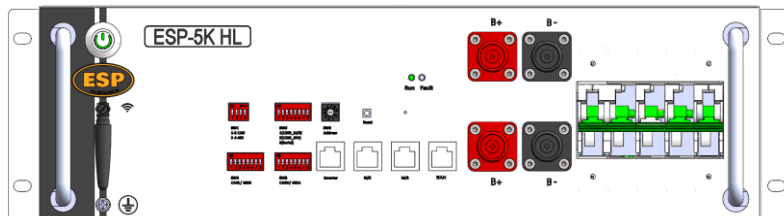

Connect all batteries in the string with a communication cable between their M/S Port. See diagram below for an example of 3 batteries connected.

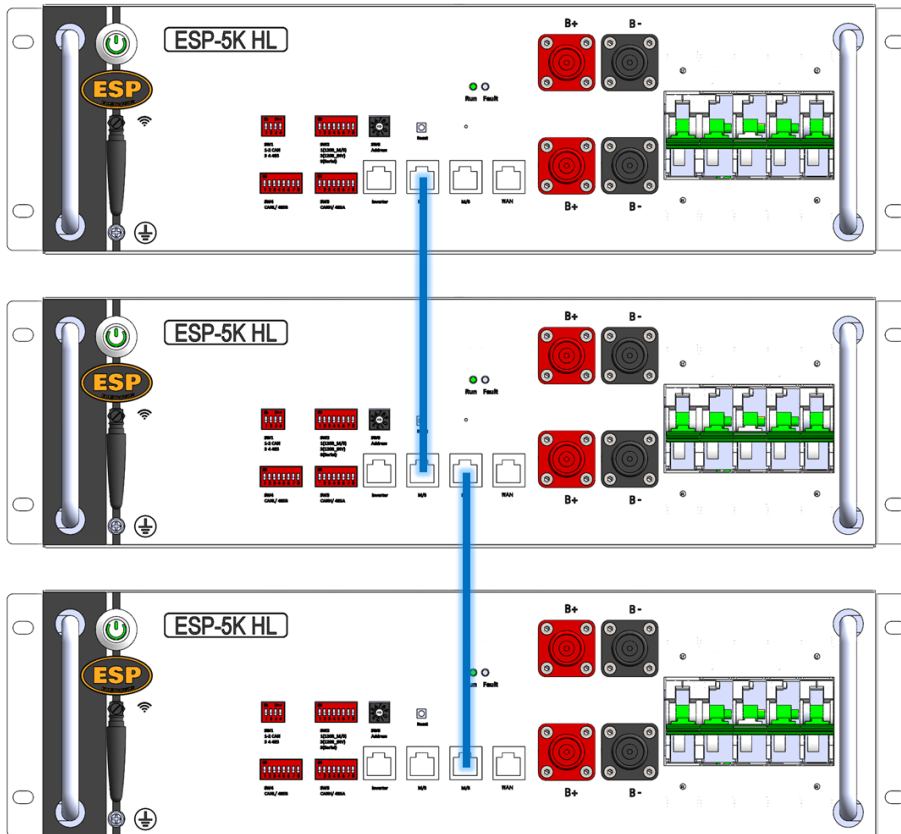

5.4.4.2 Connecting Battery string for communication with inverter

NOTICE

The battery is designed to work on a close loop environment for communicating with the inverter / PCS (check inverter compatibility list), for open loop type of applications we do not ensure proper operation.

To ensure proper functionality of the batteries, the batteries must communicate to the main inverter through the supported protocols using a communication cable. Refer to the inverter compatibility list (not included in this manual).

In a battery string only one of the batteries will acquire the role of Primary or Master (See [section 5.5](#)), this Primary battery will connect to the main inverter with the communication cable, this allows the inverter to see all the batteries as a single bank. The primary battery will use the “Inverter” Port for that purpose.



5.4.4.2.1 Communication connection example: 1 string of 4*ESP-5K-HL to a SA-12K inverter

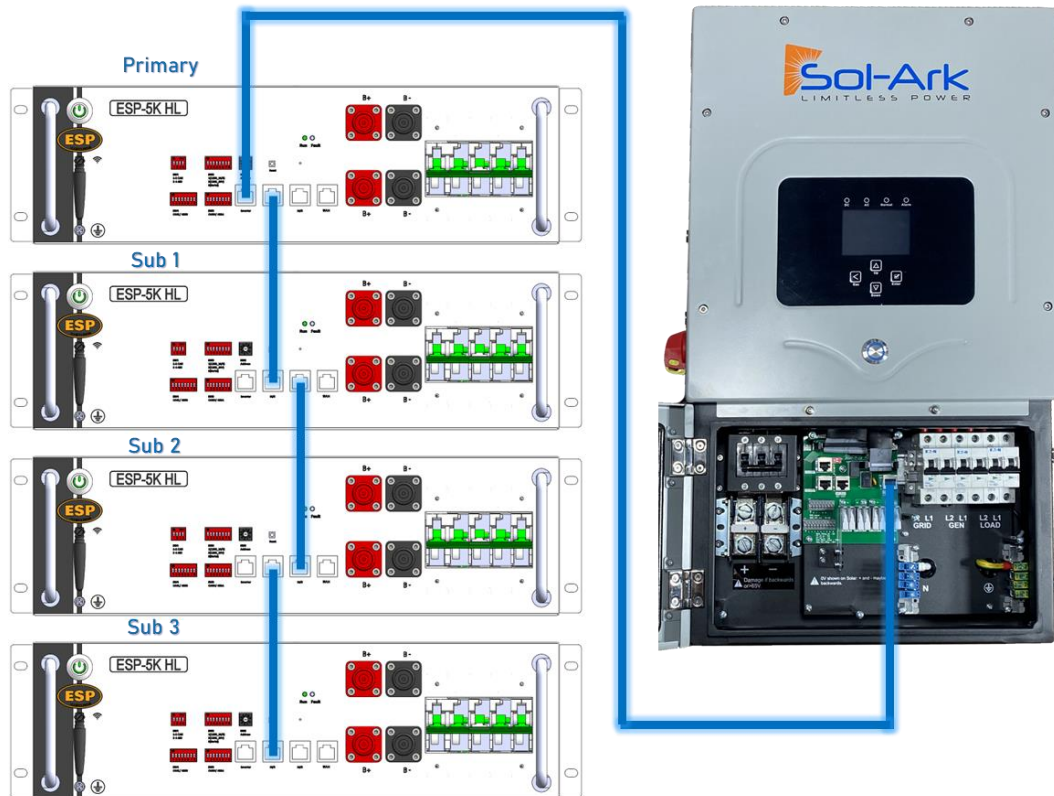

WARNING

Always follow Inverter's installation manual prior to making any connection.
This manual does not substitute inverter manual.

NOTICE

Once you completed the wiring for communication, verify the inverter manual or with inverter technical support for the correct settings on the inverter to properly ensure communication.

5.5 Battery DIP Switch Setting

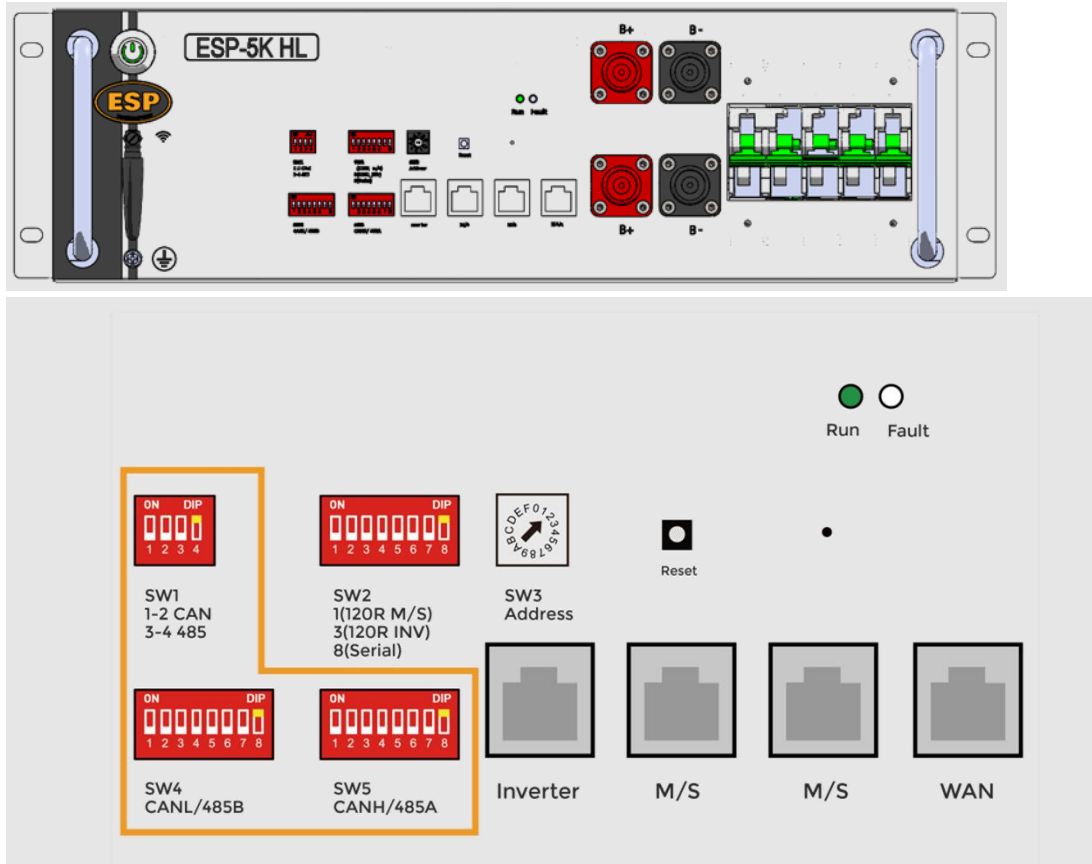

The settings for SW1/SW4/SW5 are defined in the inverter's user manual.

Note: For switches: SW1, SW2, SW4 and SW5; the "ON" position means the number is on the upper side.

WARNING:
Please ensure that the SW1/SW4/SW5 settings are correctly set to the manufacturer's default and have not been accidentally changed.
The default communication protocol for the battery is CAN (SW1: 1 & 2 on). If the inverter's communication mode is RS485 or any other protocol, please contact EndurEnergy before installing the battery. SW4 default: 5 on; SW5 default: 4 on.

In the following table, you will find the configurations for SW2 and SW3. This table includes configurations for 1 battery up to 16 batteries. Identify the actual number of batteries of your system/string and adjust the switches accordingly. The difference between parallel and series connection is as follows: For parallel connection, set SW2 DIP 8 to 'OFF', and for series connection, set SW2 DIP 8 to 'ON'. Please be careful in selecting the type of connection as this can affect the operation of your batteries.



EndurEnergy Systems, Inc.



Number of Batteries connected	Group	Set of SW 2		Address (Set of SW3)
		Series connect	Parallel connect	
1	/			
2	Primary			
	Sub 1			
3	Primary			
	Sub 1			
	Sub 2			
4	Primary			
	Sub 1			
	Sub 2			
	Sub 3			
5	Primary			
	Sub 1			
	Sub 2			



EndurEnergy Systems, Inc.



	Sub 3			
	Sub 4			
6	Primary			
	Sub 1			
	Sub 2			
	Sub 3			
	Sub 4			
	Sub 5			
7	Primary			
	Sub 1			
	Sub 2			
	Sub 3			
	Sub 4			
	Sub 5			
	Sub 6			



EndurEnergy Systems, Inc.



8	Primary			
	Sub 1			
	Sub 2			
	Sub 3			
	Sub 4			
	Sub 5			
	Sub 6			
	Sub 7			
9	Primary			
	Sub 1			
	Sub 2			
	Sub 3			
	Sub 4			
	Sub 5			
	Sub 6			



EndurEnergy Systems, Inc.



	Sub 7			
	Sub 8			
10	Primary			
	Sub 1			
	Sub 2			
	Sub 3			
	Sub 4			
	Sub 5			
	Sub 6			
	Sub 7			
	Sub 8			
	Sub 9			
11	Primary			
	Sub 1			
	Sub 2			



EndurEnergy Systems, Inc.



	Sub 3			
	Sub 4			
	Sub 5			
	Sub 6			
	Sub 7			
	Sub 8			
	Sub 9			
	Sub 10			
12	Primary			
	Sub 1			
	Sub 2			
	Sub 3			
	Sub 4			
	Sub 5			
	Sub 6			



EndurEnergy Systems, Inc.



	Sub 7			
	Sub 8			
	Sub 9			
	Sub 10			
	Sub 11			
13	Primary			
	Sub 1			
	Sub 2			
	Sub 3			
	Sub 4			
	Sub 5			
	Sub 6			
	Sub 7			
	Sub 8			
	Sub 9			



EndurEnergy Systems, Inc.



	Sub 10			
	Sub 11			
	Sub 12			
14	Primary			
	Sub 1			
	Sub 2			
	Sub 3			
	Sub 4			
	Sub 5			
	Sub 6			
	Sub 7			
	Sub 8			
	Sub 9			
	Sub 10			
Sub 11				



EndurEnergy Systems, Inc.











	Sub 12			
	Sub 13			
15	Primary			
	Sub 1			
	Sub 2			
	Sub 3			
	Sub 4			
	Sub 5			
	Sub 6			
	Sub 7			
	Sub 8			
	Sub 9			
	Sub 10			
	Sub 11			
Sub 12				



EndurEnergy Systems, Inc.



	Sub 13			
	Sub 14			
16	Primary			
	Sub 1			
	Sub 2			
	Sub 3			
	Sub 4			
	Sub 5			
	Sub 6			
	Sub 7			
	Sub 8			
	Sub 9			
	Sub 10			
Sub 11				
Sub 12				

	Sub 13			
	Sub 14			
	Sub 15			

6 Battery connectivity

The battery has Wi-Fi and WAN capabilities that allows it to be monitored remotely and perform OTA remote firmware updates, it is required a local Wi-Fi connection available or an ethernet cable from the main router to the “WAN” Port of the Primary battery. Follow below instructions to setup the system:

6.1 APP Setup

1. Search for the EndurEnergy App on Google Play Store or App Store: the app name is found as “E2 Smart”.
2. Install the App and create a user and password.
3. Login with your credentials.

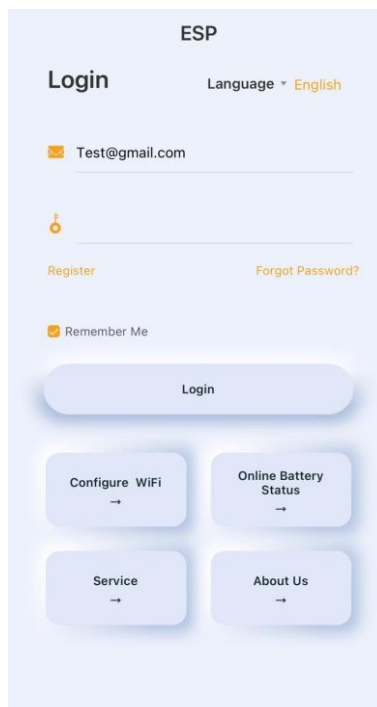

The screenshot shows the login interface of the ESP app. At the top, it says "ESP" and "Login" with a language dropdown set to "English". There is an email input field containing "Test@gmail.com" and a password input field with a lock icon. Below the password field are links for "Register" and "Forgot Password?". A "Remember Me" checkbox is checked. A large "Login" button is centered below these fields. At the bottom, there are four buttons: "Configure WiFi", "Online Battery Status", "Service", and "About Us", each with a right-pointing arrow.

6.1.1 Connect Battery to Internet - WIFI

The battery comes with a built-in Wi-Fi module for use with the App. Follow the instructions to connect the battery to the local Wi-Fi.

The ESP-5K HL battery connects to the internet all the batteries in the same string altogether, so you only require connecting the Master / Primary battery of each string you have on your system.

1. Turn on the primary battery or Master battery from the string you wish to connect to the internet and press the "Reset" button on that battery for 2 seconds. The green light on the battery will start flashing slowly, indicating that it is waiting for a WIFI connection.

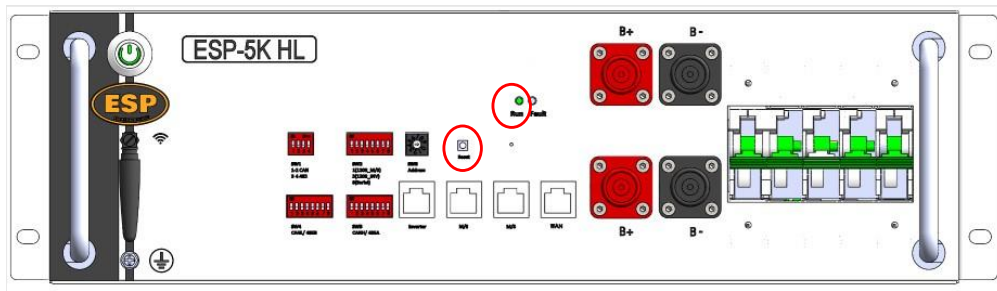

2. Make sure your phone is connected to the same Wi-Fi you wish to connect the battery to, then go to the App main screen and select the 'Config WIFI' option (you may need to logout to access this menu).
3. Select the "ESP-5K HL" Model. Select option 1 "EndurEnergy".

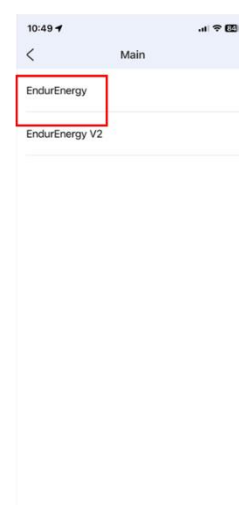
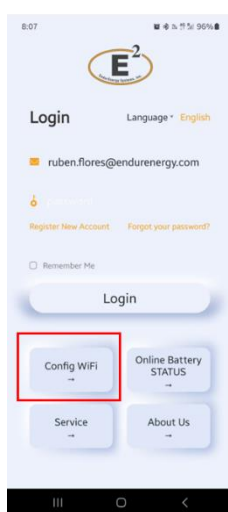

4. Enter your local Wi-Fi name and password on the textboxes, on Device count place number: 1, then press “Confirm”.
5. If connected successfully, the App will indicate an IP and MAC Address.
6. If you encounter any issues, repeat the above steps.

6.1.2 Connect Battery to Internet – Direct connection

The battery comes with a built-in ethernet port, use a CAT6a cable with RJ45 ports and connect the battery WAN port to the main router, this will allow the battery to connect to the internet.

The ESP-5K HL battery connects to the internet all the batteries in the same string altogether, so you only require connecting the Master / Primary battery of each string you have on your system.

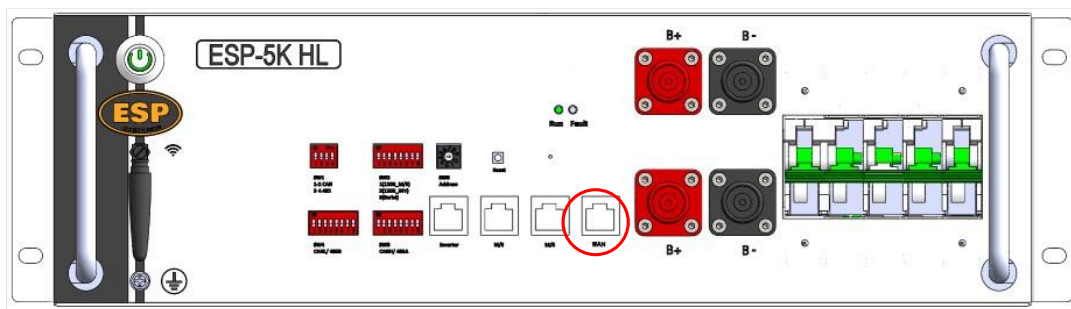

NOTICE

Carefully read our Limited Product Warranty, not connecting batteries to the internet may decrease your warranty period.

If you are unable to set up the WIFI or cannot connect directly using an ethernet cable on the WAN Port, the battery will still operate normally.

If still not able to connect please contact us at support@endurenergy.com

6.1.3 Visualize Battery Data from the App

1. Once the battery is connected to the internet via Wi-Fi or direct cable, you should be able to see the battery parameters, but first you must ensure to link the battery to your account.
2. Enter your account credentials.
3. Select Enable Remote Viewing/Editing.

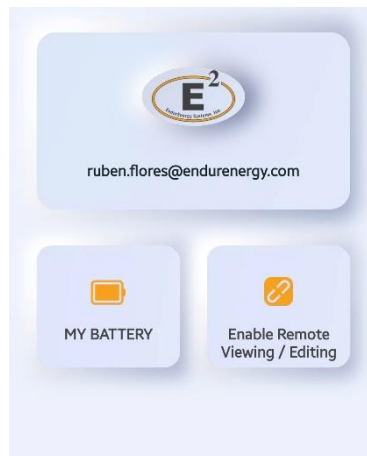

4. Scan or manually input the serial number of the battery you wish to monitor.
5. Add the battery under “MY BATTERY” section.
6. You should be able to see the parameters of that battery by selecting the serial number.

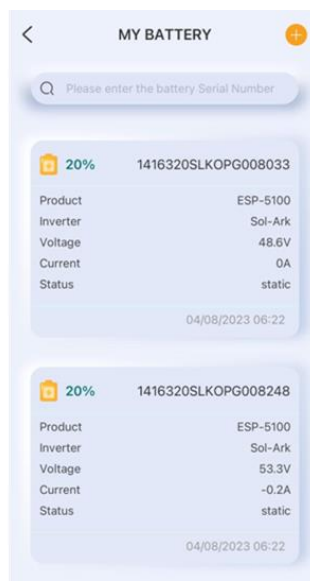
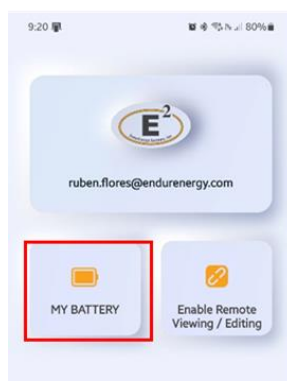

7 Commissioning

7.1 Commissioning Battery

NOTICE

The battery is designed to work on a close loop environment for communicating with the inverter / PCS (check inverter compatibility list), for open loop type of applications we do not ensure proper operation.

1. Validate voltage of each battery pack before connecting anything:
 - Press and hold the power button for 4 seconds until the “Run” indicator light turns on.
 - Trip the DC breaker to the “ON” position. **Note: The DC Breaker comes with a cover for shipping, make sure to remove it by unscrewing the 4 cover screws, this cover need to be dispatched after.**
 - If the voltage is $\leq 48V$ do not use that battery and contact support for assistance.
 - Record the voltage for that battery.
 - Trip the DC breaker to “OFF” position and then turn off the battery by pressing the power button.
 - Repeat the same for all batteries.
 - Compare all the measured voltages of the batteries, the maximum voltage difference between batteries should be less than 2V. If not, contact support for assistance.
2. Do all the cable connections, make sure to do the proper grounding, power cable (either series or parallel) and communication cables, follow instructions as per previous sections.
3. Set the DIP switches according to your battery setup by following instructions on [Section 5.5](#).
4. Follow all the inverter manual considerations prior to energizing the system. The inverter must be off before energizing the batteries.
5. Turn on the batteries by pressing and holding the power button for 4 seconds for each battery.
6. Trip the DC breaker to the “ON” position for each battery. If there is an additional external DC breaker turn it on.
7. Turn on the inverter and wait for the startup sequence to complete fully. Make sure all the batteries have the green “run” light on and no faults are present after a few minutes.
8. Follow inverter setup and manual. Contact inverter technical support if required to achieve the desired operation, in some cases a firmware update is required.
9. **Register your battery system on our website and connect batteries to the internet, failure to do so may affect the warranty period.**



EndurEnergy Systems, Inc.



7.2 Shutting Down Battery

Note: Shut down the battery only when it is not charging or discharging or connected to any loads. Make sure the Inverter is off or disconnected.

1. Turn all the battery DC Breakers to the “OFF” position.
2. Press and hold the power button for 5 seconds, then release it after hearing the relay breaking.
3. Make sure that all lights on the battery are off.

8 Firmware Update & Troubleshooting

If there is a persistent fault indicator in one or all the batteries, review the connections and dip switch settings again as well as the inverter connections and settings. If the problem persists and you require further assistance, please contact us (**see [Section 1.7](#)**).

If you need to upgrade the battery firmware version, please contact us (**see [Section 1.7](#)**).

For any open loop application you must contact us for ensuring appropriate settings are made.

Use our [Support Intake Form](#) for any assistance.

9 Warranty

Our Limited Product Warranty is not included in this manual, please find the latest version on our website.

Register your battery system on our website and connect batteries to the internet (See [Section 6](#)), failure to do so may affect the warranty period.