

THE SEDONA ELITE 2019

THE JOURNEY TO THE PERFECT ROAST CONTINUES...

Bringing together the craftsmanship of the past into the present and moving forward into the future. We introduce The Sedona Elite 2018 Models. Be it at home, in shop, or with today's rapidly growing Micro Roasters The Sedona Series continues bring you to 'The Perfect Roast'. Are you ready to take micro fresh coffee to the next level? Are you prepared to reach the top? The journey to the perfect roast continues in The Sedona Elite...

START YOUR ENGINES...
THE RACE TO PERFECTION IS ON



The Sedona Story...

**FROM THE ROASTMASTERS OF
THE PAST...INTO
& BEYOND THE PRESENT...**

FROM THE DAYS WHEN CRAFTSMEN
TOOK PRIDE IN THEIR WORK
DESIGNING TOOLS AND EQUIPMENT
THAT WENT FAR BEYOND JUST
MEETING THE NEEDS OF THE
ROASTMASTER. THIS IS NOT SIMPLY A
TOOL OF THE TRADE. THE SEDONA
ELITE IS A PRECISION TOOL DESIGNED
FOR YEARS OF QUALITY ROASTING
USING THE BEST IN TECHNOLOGY IN A
BEAUTIFULLY CRAFTED MACHINE
THAT IS A JOY TO WORK WITH. THE
BEST OF THE PAST COMBINED WITH
THE ADVANCEMENTS OF TODAY FOR
GREAT TOMORROWS.

**THE ARTISANS AND CRAFTSMAN OF
YESTERYEAR MEET THE TECHNICIANS
OF TOMORROW**



YESTERDAY, TODAY, TOMORROW

BCROASTERS.COM

NEW FOR 2019

DATA LOGGING:

WHILE THE SEDONA SERIES HAVE ALWAYS USED ARTISAN SOFTWARE ATTACHED VIA USB TO YOUR COMPUTER FOR DATA LOGGING STARTING IN 2019 WE ADD THE ABILITY TO DO DATA LOGGING WITH USB OR BT WITH ARTISAN OR OTHER BRANDS OF SOFTWARE AND EVEN VIA AN APP FOR IPHONES AND IPADS!

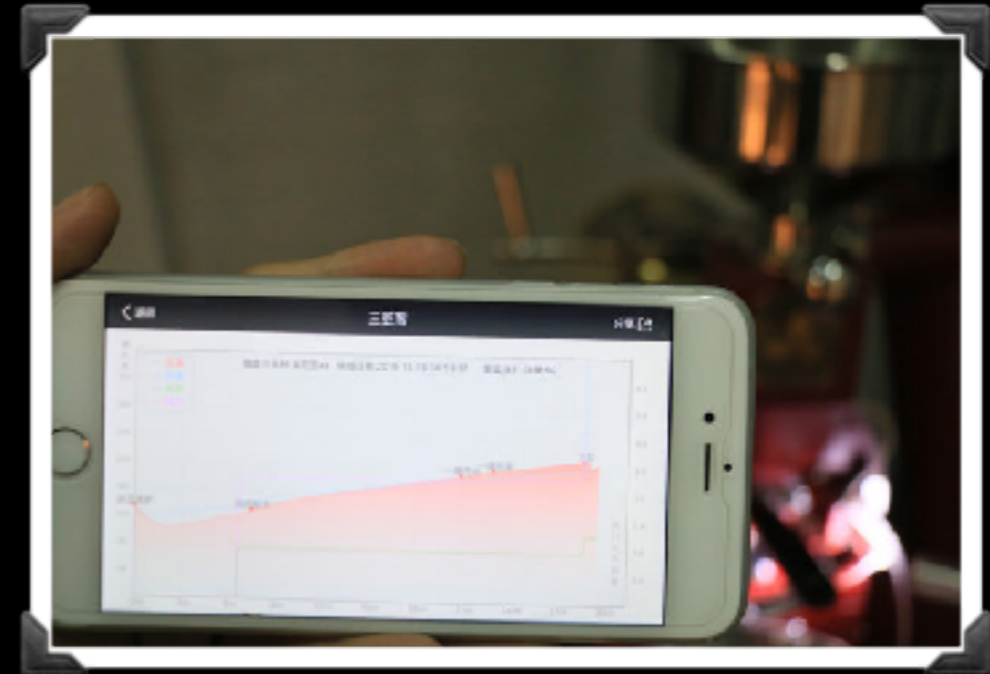

OTHER UPGRADES FOR 2019:

- *NEW SOFT GLOW BURNER SYSTEM
- *NEW STAND ALONE SEDONA ELITE 3200 DWS MODELS
- *MANY MORE INTERNAL AND SOME EXTERNAL UPGRADES



SOFT GLOW BURNERS



THE NEW
SEDONA ELITE
3200 DWS
MODELS FOR 2019!

THE 2019 LINEUP



NEW FOR 2019!

SOFT GLOW BURNER TECHNOLOGY PROVIDES EVEN UNIFORM HEATING TO ITS CERAMIC COATED SHAFTLESS SOLID CARBON STEEL DRUM FOR A MEASURE OF INFRARED HEATING

• **SEDONA SAMPLER**

EXCLUSIVELY SOLD AS A SAMPLE ROASTER. THE SEDONA SAMPLER IS THE MOST AFFORDABLE ROASTER IN THE SEDONA LINE MAKING IT A GREAT SAMPLE ROASTER FOR THE LARGER MODELS.

- ★ SHAFTLESS FAR INFRARED DRUM
- ★ CERAMIC COATED CARBON STEEL DRUM
- ★ DUAL CHANNEL TEMPERATURE CURVE OUTPUT OF BOTH BT & ET TEMPERATURES SIMULTANEOUSLY
- ★ BLUETOOTH DATA LOGGING VIA ARTISAN OR THROUGH APP.

Sedona Sampler Parameters



SEDONA SAMPLER:

ROASTING CAPACITY: 50-300G

ROASTING TIME: 8-12 MINUTES

HEATING SOURCE: LPG OR NG

SINGLE PHASE 220V 50/60HZ 120W

TEMPERATURE RANGE: 0F-500F

SIZE: 22X15X24 IN.

WEIGHT:75LB.SHIPPED CRATED

FREIGHT: 125LB.

1. SHAFT-LESS DRUM
2. DIRECT-FIRE ROW BURNER (SOFT GLOW BURNER SYSTEM)
3. SEPARATED SMOKE EXHAUST SYSTEM AND COOLING SYSTEM
4. ELECTRIC DAMPER
5. DRUM SPEED CONTROL
6. GAS PRESSURE GAUGE
7. FIRE FINE-TUNING VALVE
8. PROFESSIONAL CHAFF CYCLONE
9. DIGITAL TEMPERATURE DISPLAY FOR HOT AIR AND COFFEE BEANS
10. COMPATIBILITY FOR HALF HOT AIR AND DIRECT-FIRE ROASTING
11. LED AUXILIARY LIGHT
12. BLUETOOTH + USB DUAL CURVES
13. DIGITAL DISPLAY FOR DRUM SPEED
14. HOT-AIR PRESSURE GAUGE
15. FAR-INFRARED CERAMIC DRUM

Sedona 300



THE 300 IS A STEP UP FROM THE SAMPLER IN THAT IT HAS MANUAL DIAL DAMPER AIRFLOW CONTROL

- **SEDONA 300**

PERFECT IN THE HOME LANDSCAPE. SMALL ENOUGH FOR YOUR KITCHEN COUNTER. ELEGANT LIKE GOLD. ALWAYS AT HOME AND EVER READY TO ROAST THE PERFECT CUP.

- ★ SHAFTLESS FAR INFRARED DRUM
- ★ CERAMIC COATED CARBON STEEL DRUM
- ★ THE FINEST IN THE INDUSTRY ONLY FOR THOSE REQUIRING THE BEST AT HOME OR OFFICE
- ★ BLUETOOTH DATA LOGGING

Elite 300 Parameters

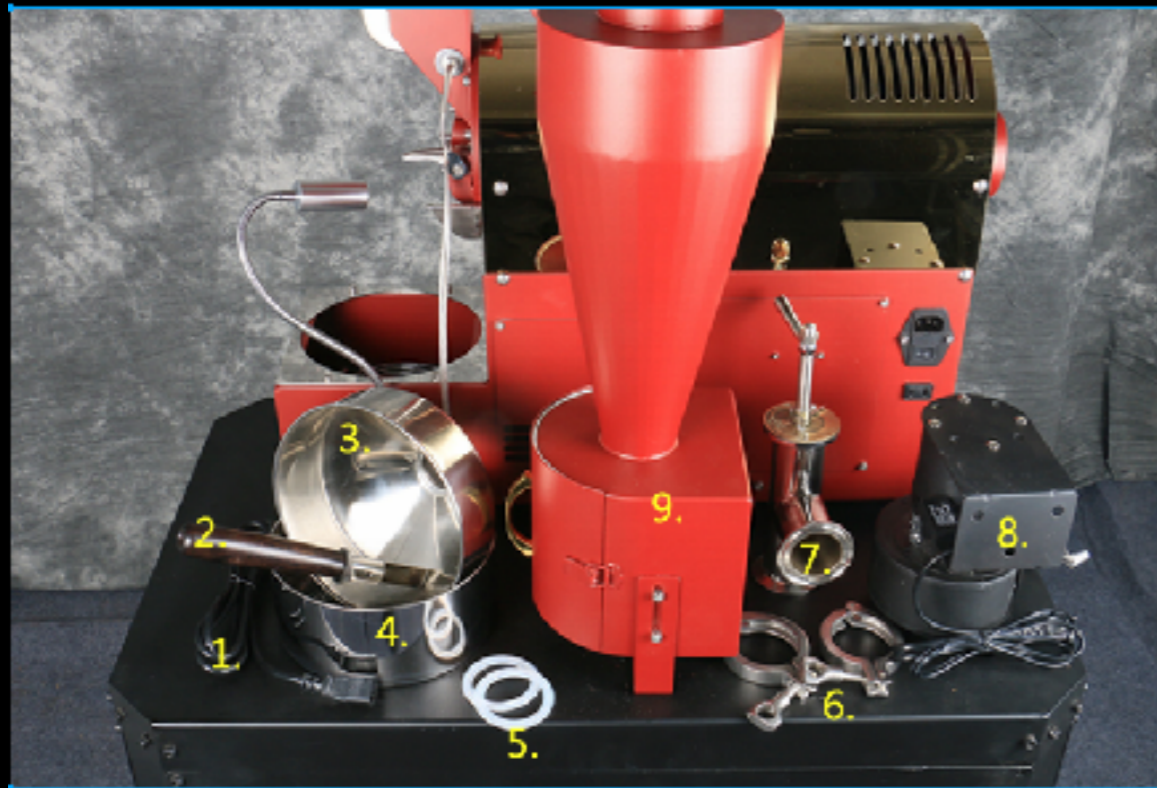

1. POWER SUPPLY CABLE
2. SAMPLER SPOON
3. HOPPER
4. COOLING TRAY
5. HOOP PADS
6. HOOPS
7. SMOKE EXHAUST DEVICE
8. HOT AIR FAN
9. CHAFF CYCLONE

- ★ DESCRIPTION: CERAMIC COATED CARBON STEEL DRUM
- ★ SOURCE: LIQUEFIED PETROLEUM GAS (GAS VERSION) LPG OR NG
- ★ FUEL PRESSURE: 0-2.8KP (LPG)
- ★ POWER: 220V 50-60HZ
- ★ ELECTRIC POWER: 200W
- ★ ROASTING AMOUNT: 100-300G
- ★ ROASTING TIMES: 10-15 MINUTES
- ★ THE INNER POT MATERIAL: THE FAR INFRARED COATING COATED CARBON STEEL
- ★ DIMENSIONS: LENGTH 1.97'X 1.21' WIDE 2.13' HIGH (60*37*65CM)
- ★ WEIGHT: 88LB (40KG)
- ★ SHIPPING WEIGHT: 125 LB. (INCLUDING PACKAGING)
- ★ DELIVERY PACKAGE: WOODEN CRATE
- ★ TRANSPORTATION: FREIGHT
- ★ BLUETOOTH DATA LOGGING ON IPHONE APP



NEW FOR 2019!

SOFT GLOW BURNER TECHNOLOGY PROVIDES EVEN UNIFORM HEATING TO IT'S CERAMIC COATED SHIFTLSS SOLID CARBON STEEL DRUM FOR A MEASURE OF INFRARED HEATING



NOW WITH SOFT GLOW BURNERS

Sedona Elite 700

• Sedona Elite 700

MAKES THE PERFECT SAMPLE OR SHOP ROASTER. CAPABLE OF REPEATABLE ROASTS AS LOW AS 3.5 OZ. TO 1.5 LB. ALIVE IN A COFFEE SHOP. EXCELS AT CUSTOM ROASTS AND FLAWLESS AS A SAMPLE ROASTER FOR ALL CARBON STEEL DRUM ROASTERS. ALL PROFESSIONAL WITH FAR INFRARED TECHNOLOGY WITH INNER POT COATED IN CERAMIC FINISH WITH WINDOW, SAMPLE SPOON, COMPUTER PROFILE SYSTEM ABILITY. SHAFTLESS CARBON STEEL DRUM WITH INDEPENDENT COOLING MOTORS AND DIRECT DRIVE DRUM MOTOR. LED LIGHT AND ATTACHED CHAFF UNIT AND CHROME PLATED COOLING TRAY.

NOW WITH BLUETOOTH TECHNOLOGY FOR DATA LOGGING WITH AN IPHONE OR IPAD!

IN LPG GAS, NATURAL GAS AND ALL ELECTRIC

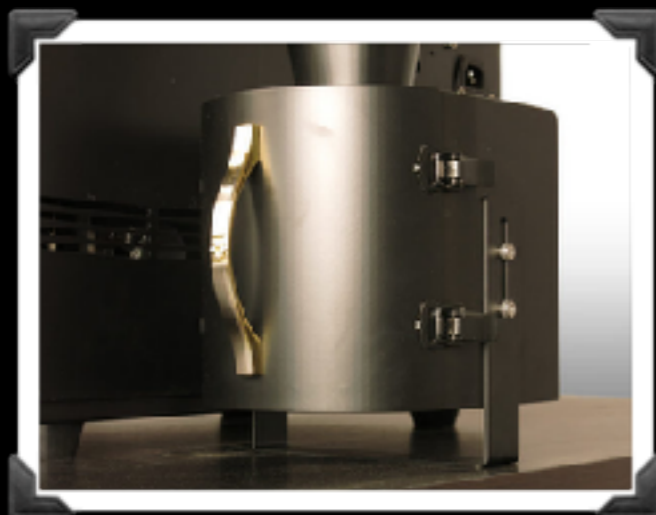

Direct Connect Chaff Unit
Easy to empty & clean drawer type chaff unit

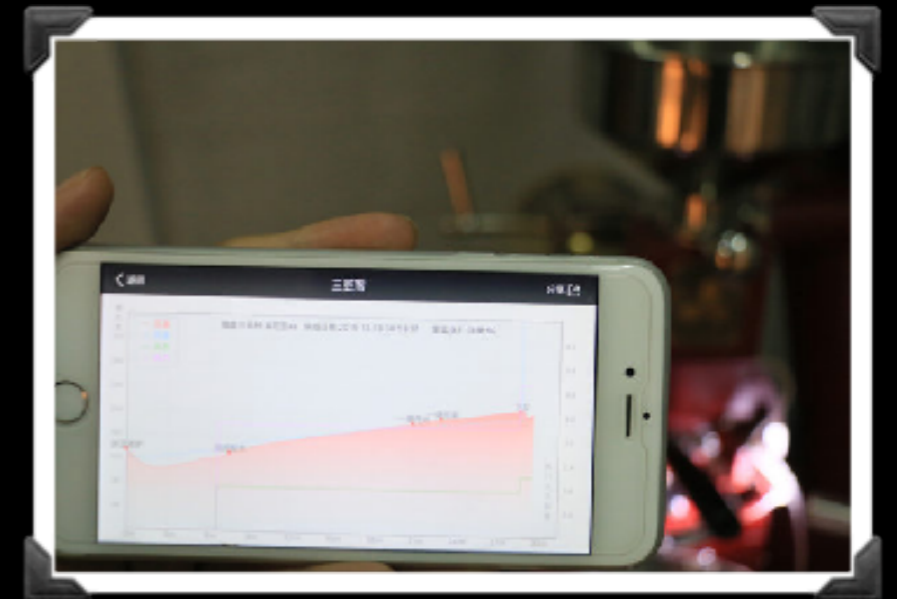

Data Log on an iPhone or iPad APP



Drum Speed Control

Elite 700 Parameters

- ★ Machine Description: Semi-hot coffee roasting machines
- ★ Heat source: liquefied petroleum gas (gas version) LPG
- ★ Fuel pressure: 0-2.8kp (LPG)
- ★ Power: 220V 50-60 Hz
- ★ Electric Power: 300W / 3300W (electric heating version)
- ★ Roasting amount: 100-700G
- ★ The inner pot Material: the far infrared coating coated carbon Steel
- ★ Dimensions: length 2.46' x 1.96' wide and 2.79' high
- ★ Shipping Weight: 165 lb. (including packaging)
- ★ Delivery Package: wooden crate
- ★ Transportation: freight



ELECTRIC 700



GAS TYPE 700

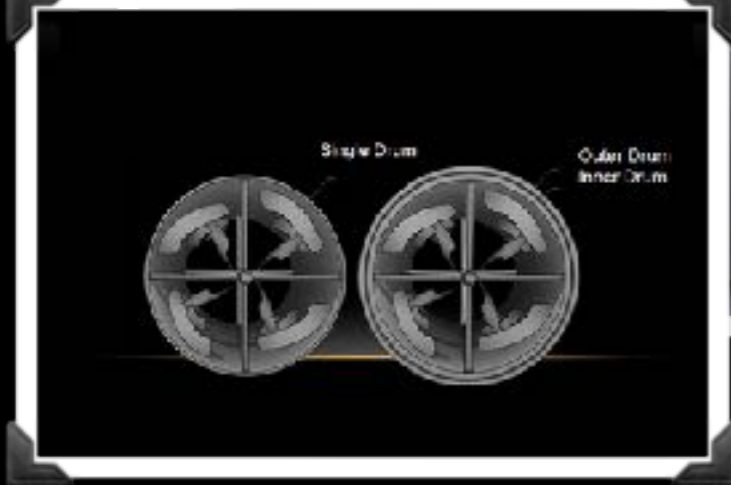

SEDONA ELITE 2000 DW

SEDONA ELITE 2000DW

CAFE OR COFFEE SHOP SIZE. ROASTS UP TO 2000 GRAMS OR 4.4 LB. PER ROAST. COMPACT BODY FOR SMALL SPACES BUT STILL PERFORMS SOLID 4 TO 5 ROASTS PER HOUR. EYE CATCHING DESIGN PERFECT FOR ADVERTISING YOUR MICRO FRESH ROASTED COFFEE. ABLE TO MAKE MORE THAN ENOUGH FOR SHOPS AND FOR SELLING COFFEE BAGGED. ALL THE FEATURES OF THE 3200 & 700 IN A SMALLER SETUP. COMES IN CHOICE OF FUJI CONTROL PANEL WITH USB DATA PROFILING VIA ARTISAN SOFTWARE OR NEW BLUETOOTH MODEL WITH IPHONE/IPAD APP FOR PROFILING- YOU CHOOSE!

DW= Double Wall Carbon Steel Drum

SEDONA ELITE 2000DW

Parameters

- ★ ROASTING MACHINE TYPE: SEMI-HOT COFFEE ROASTING MACHINES
- ★ SOURCE: LPG OR NG
- ★ WORKING AIR PRESSURE: 0-2.8KP (LPG)
- ★ POWER: 220V 50-60HZ
- ★ ELECTRIC POWER: 500W
- ★ ROASTING RANGE: 17 OZ. TO 4.4 LB.
- ★ THE INNER POT MATERIAL: DOUBLE WALL CARBON STEEL
- ★ DIMENSIONS: LENGTH 3.69'X 1.96' WIDTH X 4.26' HEIGHT
- ★ SHIPPING WEIGHT: 308 LB. (INCLUDING PACKAGING)
- ★ DELIVERY PACKAGE: WOODEN CRATE
- ★ TRANSPORTATION: FREIGHT



2018 MODEL BURNERS



2019 MODEL SOFT GLOW BURNERS



Sedona Elite 3200DW



**New! Sedona Elite 3200DW
Automated**

Now in 3 body Colors: White, Red & Black!

NEW 2019
SEDONA ELITE 3200 DWS MODELS

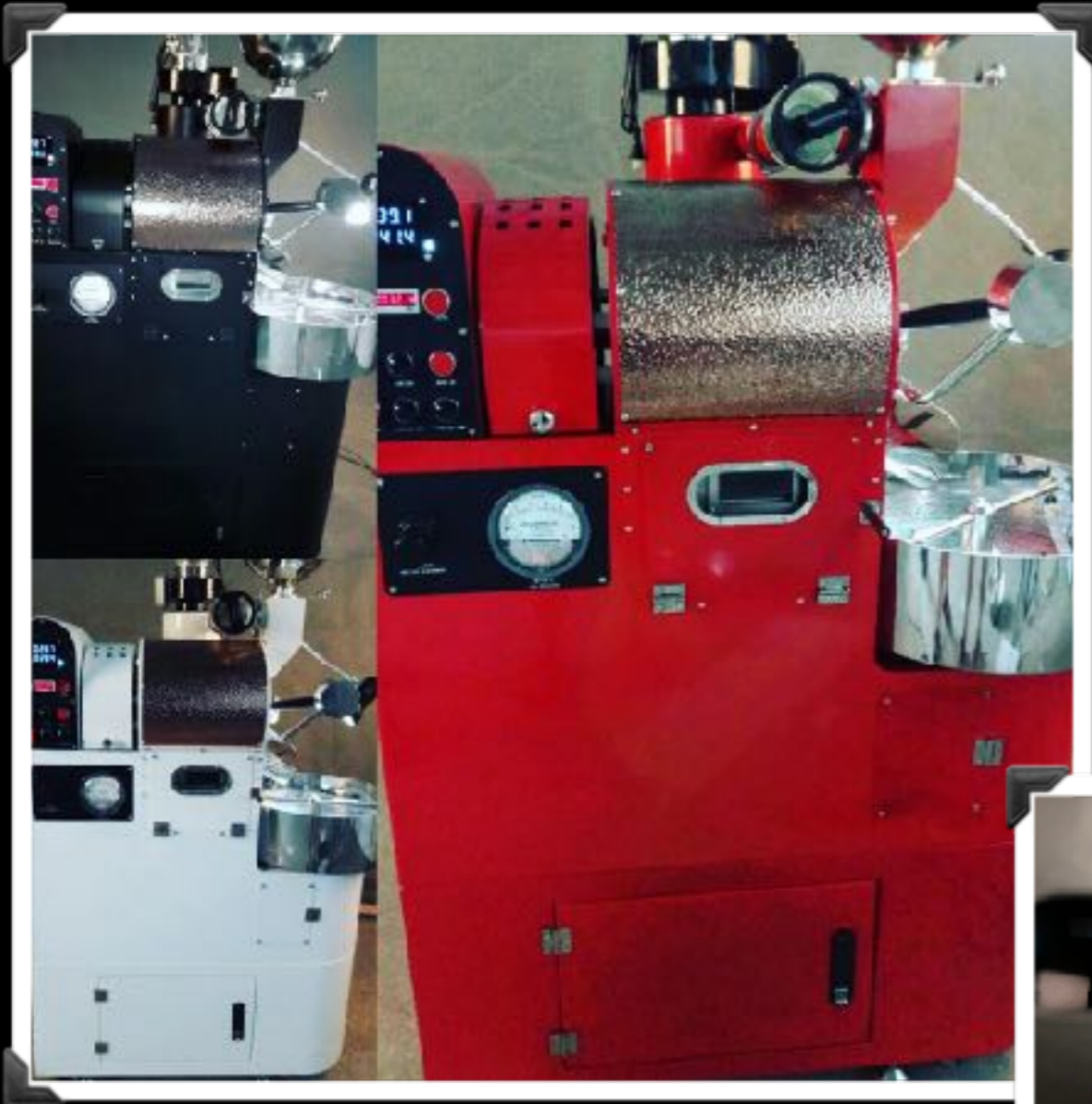

The all new 2019 Sedona
Elite DWS

IS A FLOOR STANDING MODEL USING ALL THE SAME TECHNOLOGY AS THE 3200DW BUT REQUIRES NO STAND FOR UNIT TO SIT ON. FURTHER IT ALLOWS EXTRA STORAGE FOR TOOLS AND WHEELS TO MOVE ROASTER AS NEEDED.

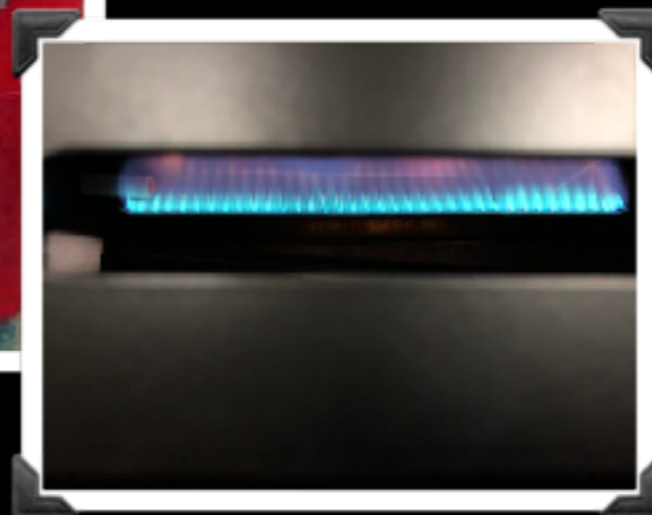

ALL 2019 SEDONA MODELS OFFER THE NEW SOFT GLOW BURNER SYSTEM

SEDONA ELITE 3200DW & DWS

THE SEDONA ELITE 3200 IS THE WORKHORSE OF THE ELITE LINE. IT IS ALSO THE MOST VERSATILE ROASTER ABLE TO DO REPEATABLE ROASTS AS SMALL AS 17 OZ. AS WELL AS ROASTING 7-8 LB. PER ROAST AND AS MANY AS 5 ROASTS AN HOUR. AND THE 3200 IS SIMPLY BEAUTIFUL! CHOOSE BETWEEN BLACK, RED OR WHITE WITH GOLD HAMMERED HOUSING. THE SEDONA ELITE 3200 COMES STANDARD WITH ALL THE ADD ON EXTRAS THE COMPETITION CHARGES A FORTUNE FOR.

ALSO NEW FOR IS THE AUTOMATED ELITE 3200DW!

THE JOURNEY TO THE PERFECT ROAST CONTINUES!

SEDONA ELITE 3200DW parameters:

- ★ SOURCE: LPG OR NATURAL GAS
- ★ GAS PRESSURE: 0-2.8KP (LPG)
- ★ POWER: 220V 50-60HZ
- ★ ELECTRIC: 500W
- ★ ROASTING RANGE: 17 OZ.-7-8 LB.
- ★ THE INNER DRUM MATERIAL:
★ CARBON STEEL DOUBLE WALL
- ★ CHOICE OF FUJI CONTROLS WITH USB PROFILING OR BT ON MANUAL UNIT
- ★ BLUETOOTH WITH IPHONE APP OR USB DATA LOGGING ON AUTOMATED
★ MODEL
- ★ DIMENSIONS:LxWxH 44X 29X50 INCHES
- ★ WEIGHT: 396 LB. (INCLUDING PACKAGING)
- ★ DELIVERY PACKAGE: WOODEN CRATE
- ★ TRANSPORTATION: FREIGHT

**DOUBLE-WALL
ADVANTAGE:**



SEDONA ELITE 6000

CHOICE OF MANUAL OR AUTOMATED MODEL

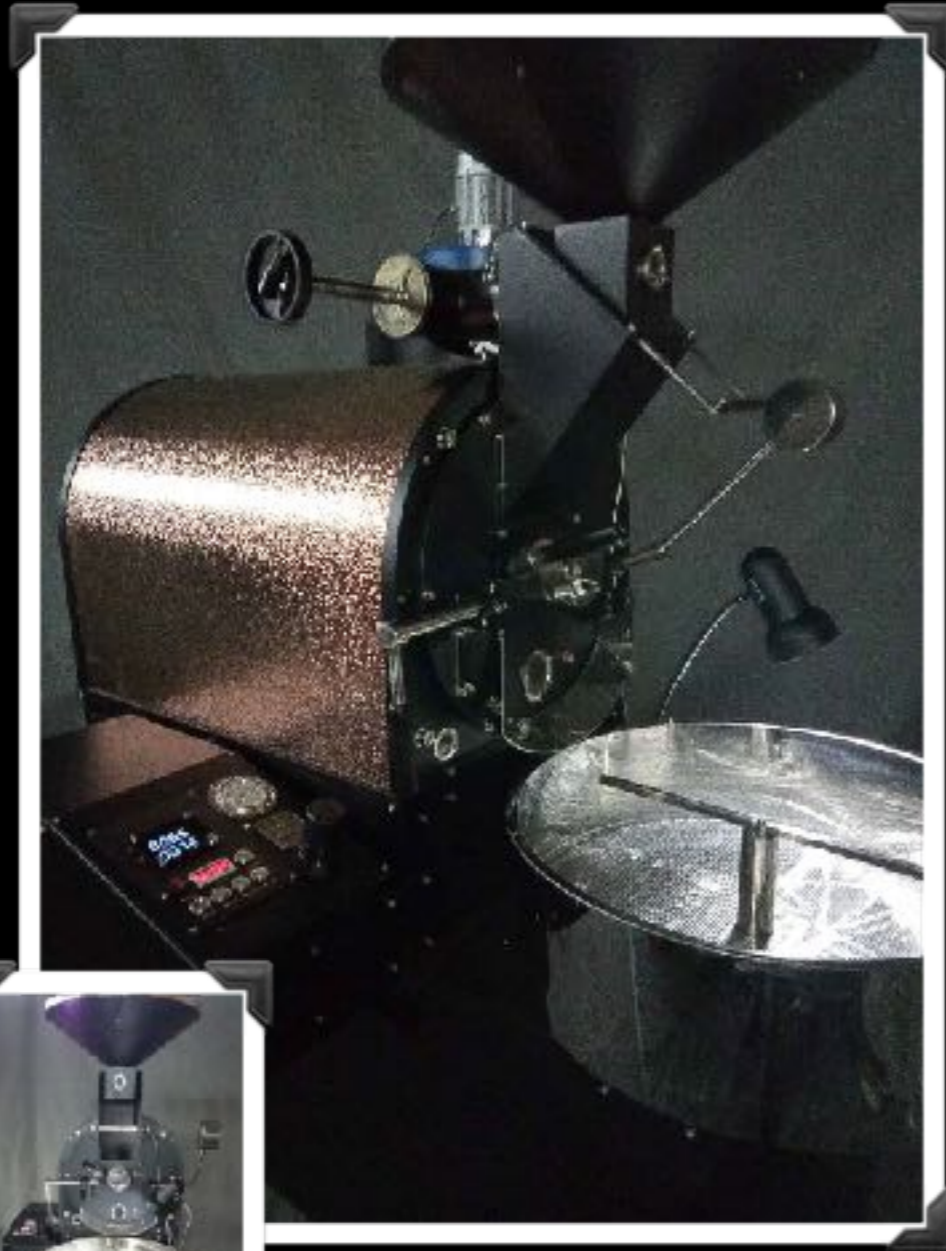

MANUAL 6000



AUTOMATED 6000

SEDONA ELITE 6000DW

THE ELITE 6000 ROASTS MELLOW EVEN ROASTS EVERY TIME WITH IT'S DOUBLE WALL CARBON STEEL DRUM CERAMIC COATED TO PREVENT STICKING. THE 6000 ROASTS OVER 13 LB. PER BATCH AND UP TO 5 BATCHES PER HOUR. THAT'S OVER 520 LB. A DAY. EVERY OPTION THE

'BIG BOYS' OFFER AT A PREMIUM COMES STANDARD:

- * CHROME STAINLESS STEEL FOOD GRADE COMPONENTS
- * THE HIGHEST QUALITY FUJI ELECTRONIC COMPONENTS
- * VARIABLE SPEED DOUBLE WALL DRUM
- * COMPUTER PROFILING WITH ARTISAN SOFTWARE
- * AND SO MUCH MORE!!
- * CHOICE OF MANUAL OR AUTOMATED ROASTER

GET READY TO BE
IMPRESSED WITH
THE SEDONA ELITE 6000



SEDONA ELITE 6000 parameters:

CHOOSE ALL MANUAL OR AUTOMATED MODEL:

- ★ ROASTING TYPE: NATURAL GAS OR LPG
- ★ SOURCE: LPG OR NATURAL GAS
- ★ GAS PRESSURE: 0-2.8KP (LPG)
- ★ POWER: 220V 50/60HZ
- ★ ELECTRIC POWER: 1500W
- ★ ROASTING RANGE: 2.2 LB.-13.22 LB. (500-6000G)
- ★ THE INNER DRUM DESIGN: DOUBLE INNER POT (CARBON STEEL)
- ★ DIMENSIONS: (142*84*172CM)(LxWxH 56x33x68")
- ★ WEIGHT: 1364LB. (GROSS 1804LB.)
- ★ DELIVERY PACKAGE: WOODEN CRATE
- ★ TRANSPORTATION: FREIGHT

SEDONA 12000A



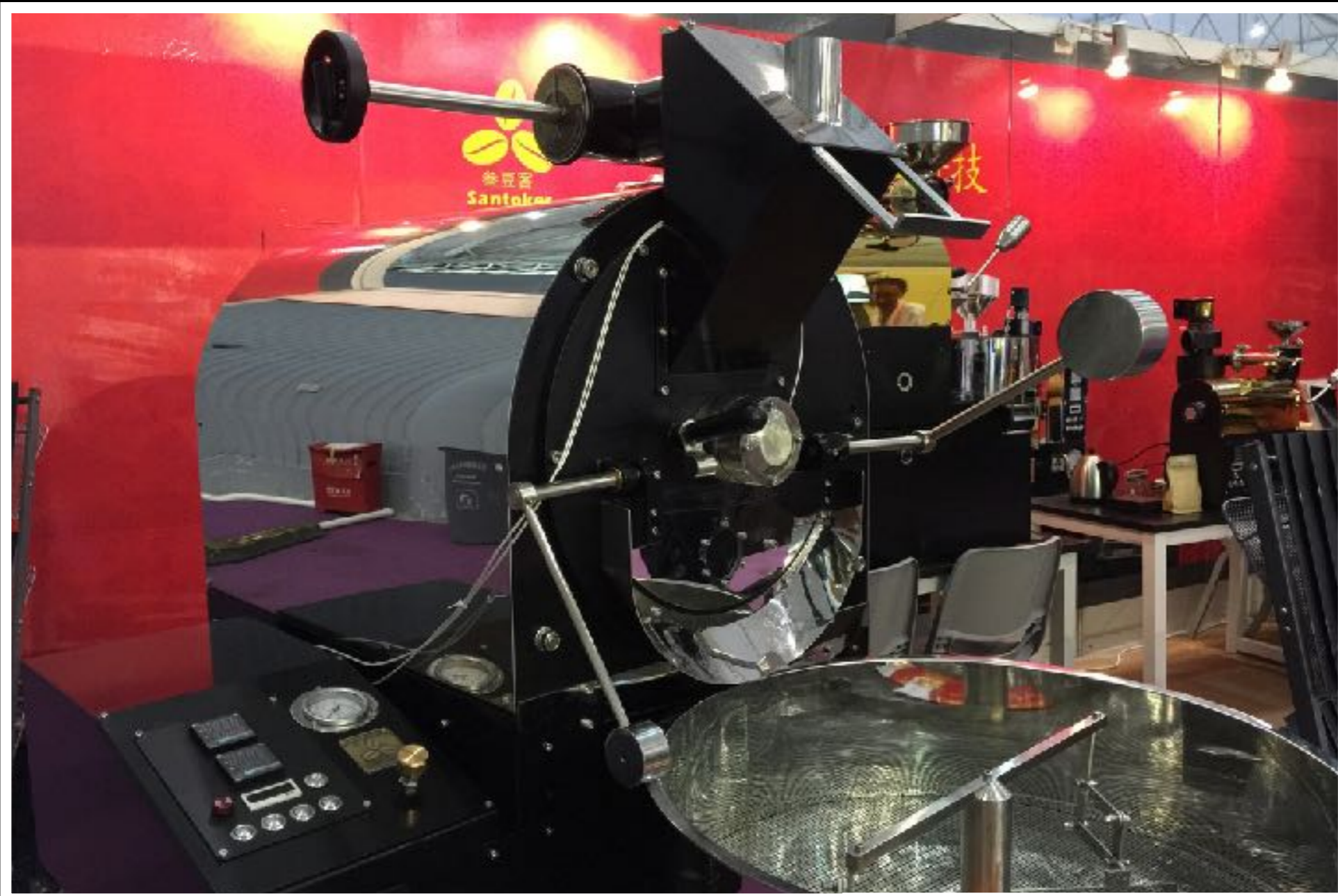

ELITE 12000M

**THE 12000 COMES IN CHOICE OF MANUAL
OR AUTOMATED
(EMAIL US FOR MORE DETAILS)**



Sedona Elite 12000 in Manual or Automated

- ★ HEAT SOURCE: GAS LPG OR NG
- ★ VOLTAGE: 220V 50/60HZ
- ★ POWER: 2000W
- ★ ROASTING CAPACITY: 2.2LB TO 26.4LB
- ★ DATA LOGGER: VIA BLUETOOTH WITH IPHONE APP OR USB WITH ARTISAN SOFTWARE
- ★ MACHINE SIZE: (142*86*185CM) (56X34X73")
- ★ MACHINE WEIGHT: 1716LB. NET 1870LB. GROSS

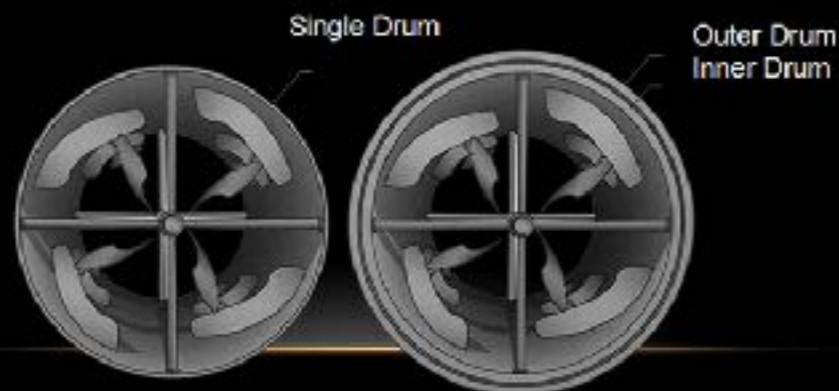

THE SEDONA 2000 TO
12000 ARE ALL DOUBLE
WALL CARBON STEEL DRUMS

SEDONA ELITE 2018



SEDONA ROASTERS CAN BE CUSTOM MADE FOR ALL COUNTRIES

BUCKEYE ARIZONA ROASTING COMPANY

BUCKEYECOFFEE.COM

623.332.1360

INFO@BUCKEYECOFFEE.COM

YOUR JOURNEY TO THE PERFECT ROAST BEGINS IN SEDONA