

2021 BC-5 SW & DW

BY BCROASTERS.COM

THE 2020 BC-5 COMES IN YOUR CHOICE OF SINGLE OR DOUBLE WALL DRUM MODELS. THE BIGGEST ADVANTAGE OF THE DW MODELS IS ITS ABILITY TO DO SMALLER BATCHES FOR SAMPLES. THE BC-5 IS OUR BEST SELLING ROASTER GREAT FOR A COFFEE SHOP OR A HOME STARTUP BUSINESS. IT CAN ROAST FROM 8OZ. TO 5LB. PER ROAST ON THE DOUBLE WALL UNIT (16OZ.-5LB. ON SW) AND UP TO 5 ROASTS PER HOUR ON THE GAS MODELS. MANY ARE ROASTING OVER 5LB. PER ROAST IN THE GAS MODELS. IT HAS ALL THE FEATURES MOST COMPANIES CHARGE EXTRA FOR BUILT INTO THE BASE PRICE. PRECISE AIRFLOW CONTROL VIA THE MDDS (MANUAL DAMPER) SYSTEM. SOLID HEAVY-DUTY STAINLESS STEEL DRUM AND BUILT IN PROFILING SYSTEM VIA ARTISAN OR CROPSTER FOR BT & ET. DIRECT-CONNECT CHAFF UNIT FOR GREATER EFFICIENCY & REDUCED FOOTPRINT. COMES IN CHOICE OF GAS OR ALL ELECTRIC. NOW IN BLACK, RED & WHITE BODY COLORS!



NEW 3MM THERMOCOUPLES FOR 2021 MODELS

FEATURES

DRUM TYPE
DATA LOGGING
THERMOCOUPLES
CONTROL PANEL
WARRANTY
PARTS AVAILABLE
110V CONVERTER

Single wall 304SS Drum 4mm
2 OMRON CONTROLS w/BT & ET
K-TYPE for BT & ET
BT & ET VEIW ON PANEL
1 YEAR PARTS & INSTRUCTION
10 Year Parts Available Guarantee
110V Voltage Converter 100W

BC-5MD	GAS TYPE	ELECTRIC
Batch Size	8oz-5lb.	8oz-4.4lb
Roasting Time	9-14 minutes	15min.
Production	20-25lb.hr	20lb. hr.
Heat Source	NG/LPG	electric
Voltage	220V	220V
Wattage	295W	5295W
Drum Motor	90W	60W
Chaff Fan Motor	45W	45W
Cooling Fan Motor	90W	90W
MIXING ARM	15W	15W
BTU	45,000	
NG PRESSURE	7-12WC	
LPG PRESSURE	MAX. 16-20WC	
Gas Consumption	0.4kg/hr	
Roaster Dim.	42x27x39	42x27x39
Roaster Weight	353lb.	353lb.

BC ROASTER COLORS

**BC ROASTERS NOW COME IN 3 BODY COLORS:
BLACK, RED & WHITE**



**BLACK BODY WITH BLACK
CHECKERED HOUSING**



**RED BODY WITH GOLD
CHECKERED HOUSING**



**WHITE BODY WITH
ROSE GOLD HOUSING**

**TWO NEW TEXTURED
HOUSINGS FOR 2021:**

GOLD MOSAIC

**HOUSING COLORS INCLUDE 3 SOLID COLORS:
ROSE GOLD, BLACK TITANIUM, STAINLESS**
(COLORS MAY VARY FROM PICTURES SLIGHTLY)

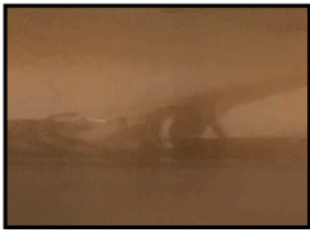

ROSE GOLD



STAINLESS



BLACK TITANIUM



SILVER RAINDROP

**ALSO HOUSING COLORS IN TEXTURED CHECKERED COLORS:
CHECKERED BLACK, SILVER OR GOLD:**

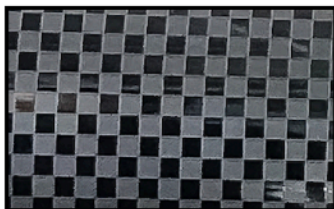

CHECKERED BLACK

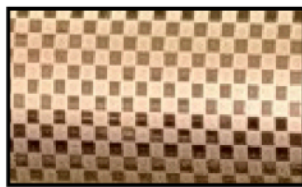

CHECKERED GOLD

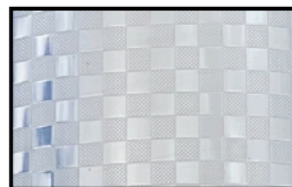

CHECKERED SILVER



**BODY COLORS:
BLACK, RED OR WHITE**

**SOLID HOUSING COLORS: ROSE GOLD, BLACK
TITANIUM, STAINLESS**

**TEXTURE HOUSINGS: CHECKERED GOLD,
CHECKERED BLACK OR CHECKERED SILVER**

NEW 2021 FEATURES & OPTIONS:

- + COOLING TRAY FAN IS VERTICAL FOR EASY VENTING
- + **NEW 3MM THICK THERMOCOUPLES**
- + OPTIONAL COOLING TRAY COVER NEW FOR 2021!



2021 MODELS HAVE COOLING TRAY FANS THAT ARE VERTICAL FOR EASY VENTING

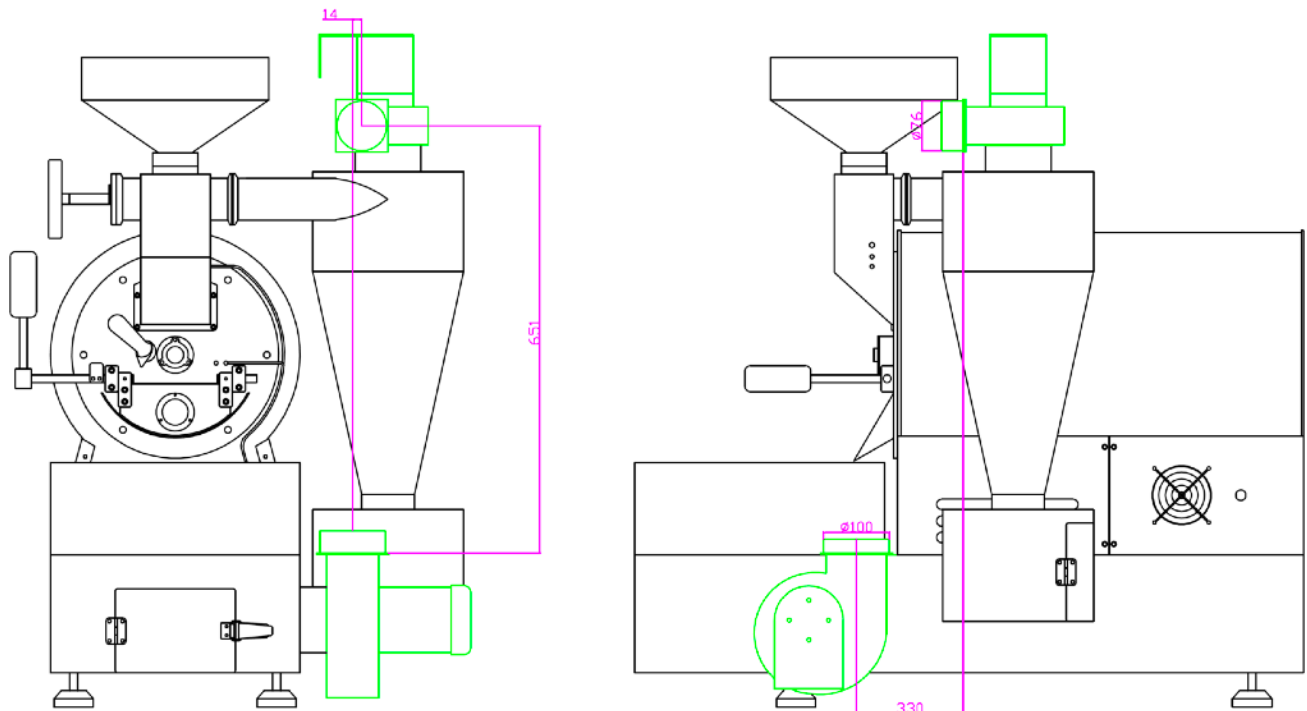

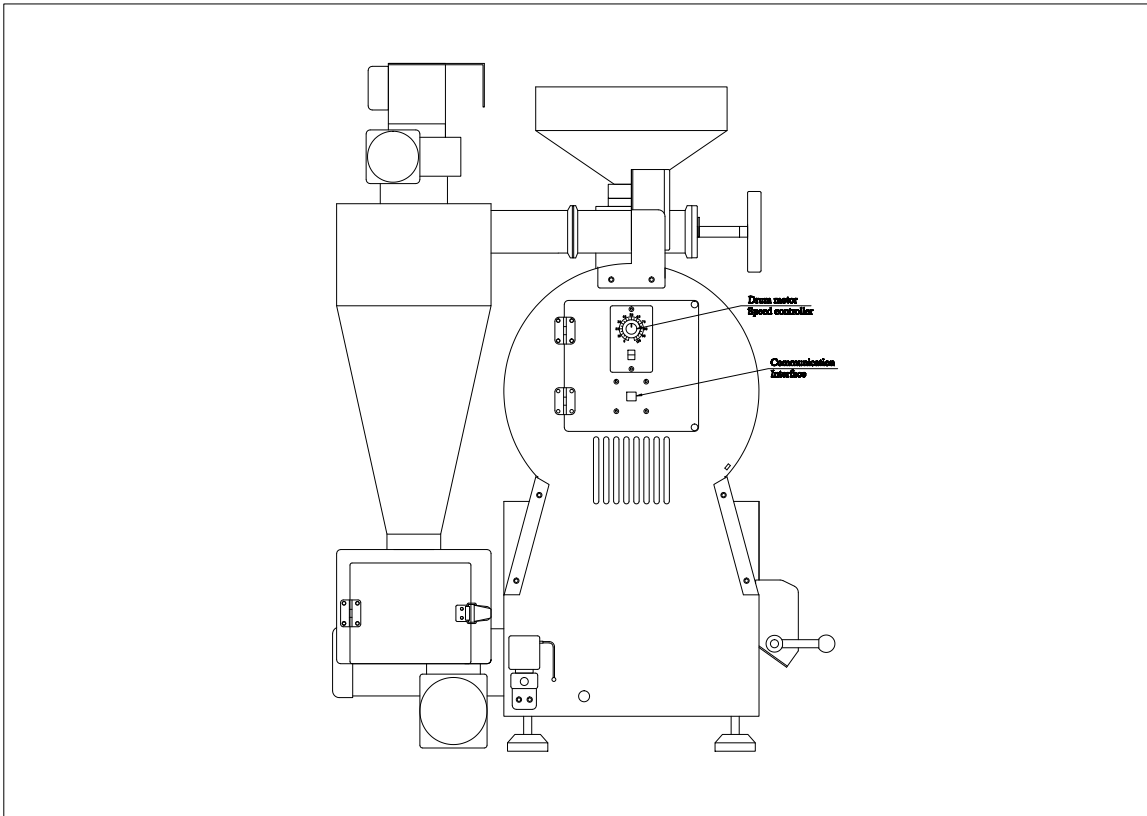
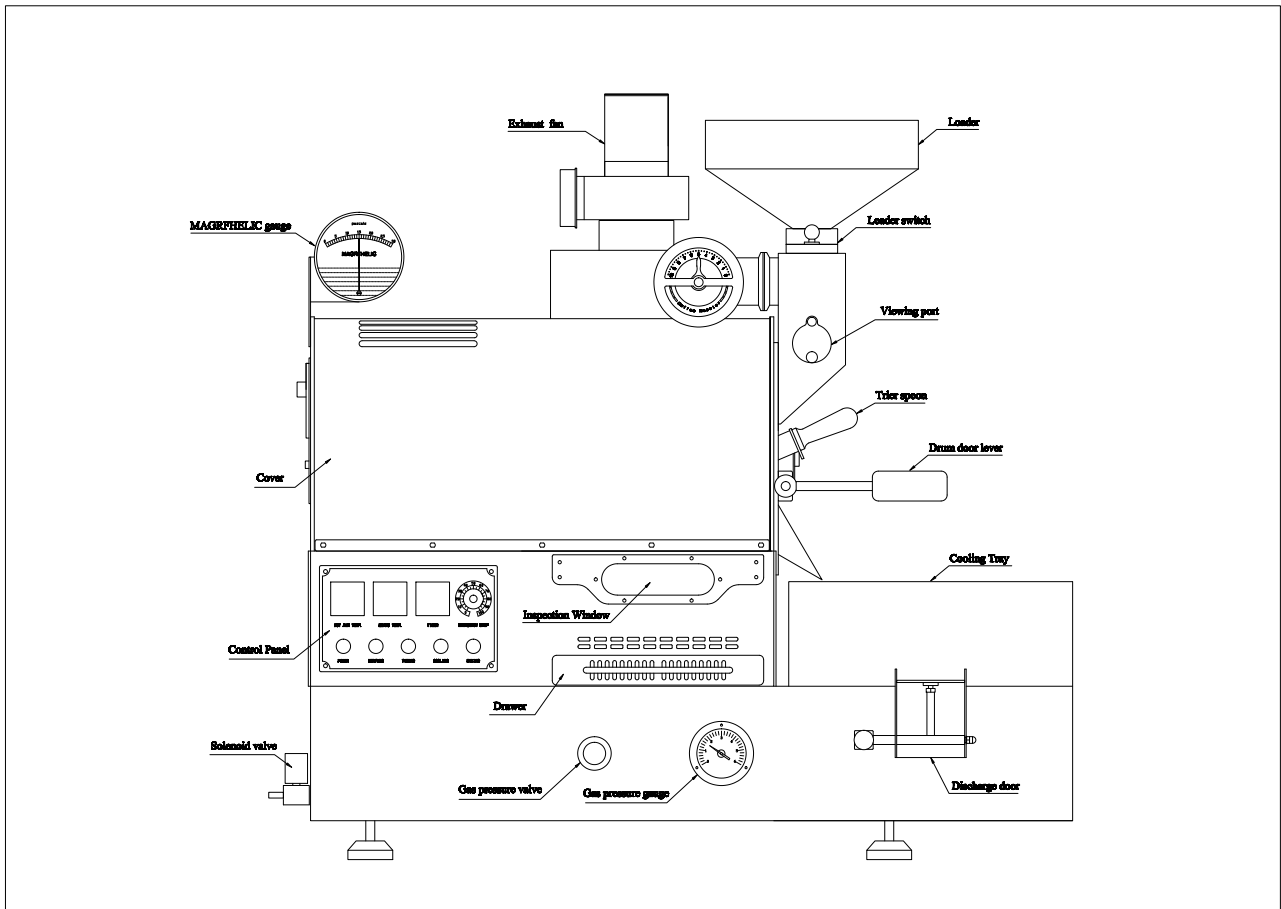

TWO EXHAUST PIPES COME OFF THE BC-5MD. FROM 2018 ONWARD MODELS HAVE UPDATED THE COOLING TRAY FAN WITH A 4" EXHAUST AND A 3" CHAFF FAN EXHAUST

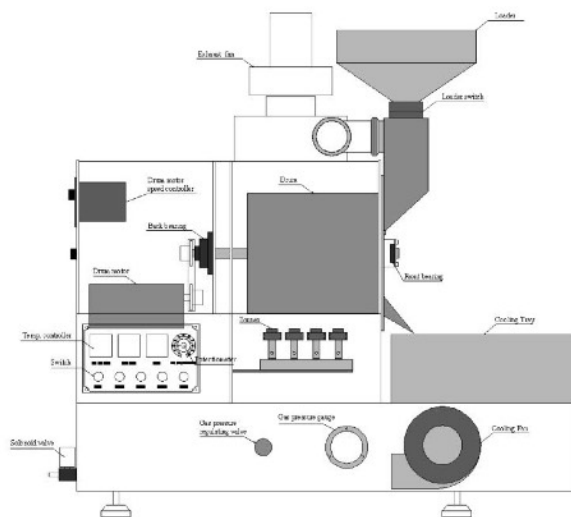

BC-5 COMMERCIAL COFFEE ROASTER	
	<ul style="list-style-type: none"> *TABLETOP OR STAND MODEL (18-24" STAND SUGGESTED) *DIRECT CONNECT CHAFF UNIT FOR SMALLER FOOTPRINT *CHOICE OF ALL ELECTRIC OR GAS MODELS
SIZE SETUP (LxWxH)	42x27x39" (INCLUDES DIRECT CONNECT CHAFF UNIT IN MEASUREMENT)
WEIGHT	353LB
MINIMUM CLEARANCE FROM COMBUSTABLE MATERIALS	18-24"
ROASTING CAPACITY	1-5LB SINGLE WALL 8OZ TO 5LB DOUBLE WALL
ROAST TIME & ROASTS PER HOUR	9-14 MINUTES (5 ROASTS PER HOUR GAS. 3.5 PER HOUR ELECTRIC)
DRUM INFORMATION	<p>SW DRUM: 4MM SUPERIOR 304SS CONTAINS 18% CHROMIUM AND 8% NICKEL</p> <p>DW DRUM: HAS TWO LAYERS OF 2MM 304SS WITH 4MM OF AIR CUSHION. SS WELDING</p>
ELECTRIC STATS:	<p>GAS MODEL: SINGLE PHASE 220V 50/60HZ 295W REQUIRES STANDARD 15A BREAKER</p> <p>ALL ELECTRIC MODELS: SINGLE PHASE 220V 50/60HZ 5295W REQUIRES 30A DEDICATED BREAKER</p>
ELECTRICAL PLUG TYPE	<p>GAS MODELS: 20A 250V 3 WIRE NEMA 6-20P</p> <p>ELECTRIC TYPE: LOCKING PLUG 250V 30A NEMA L6-30P</p>
FUEL CHOICES ON GAS MODELS	LPG GAS STANDARD WITH MODELS. NATURAL GAS CONVERSION KITS OFFERED FOR CUSTOMER INSTALLATION ONLY.
BURNER INFORMATION ON GAS MODELS	<p>SW BURNERS: 8 STANDARD HD BURNERS</p> <p>DW BURNERS: 10 STANDARD HD BURNERS</p>
BTU REQUIRMENTS	40,000 BTU MINIMUM REQUIRED FOR NG LINE
GAS PRESSURE	<p>LPG: 12-16WC (3-4KPA) MARSHALL 1912/197 REGULATOR RECOMMENDED</p> <p>NG: 7-14WC</p>

EXHAUST SETUP	
EXHAUST PIPE REQUIREMENTS	POSITIVE PRESSURE EXHAUST VENTING WITH MINIMUM CLEARANCE 18-24" FROM COMBUSTABLE MATERIALS
MAXIMUM VENTING LENGTHS	20-25' FROM CHAFF UNIT. DEDUCT 3-5' FOR 45-90 DEGREE PIPE ELBOWS. IF YOU MUST VENT AT LONGER LENGTHS CONSULT A LOCAL TECHNICIAN ON USE OF POSSIBLE BOOSTER FANS
MAXIMUM EXHAUST TEMPERATURES	425-475F
CHAFF UNIT HIGH TEMP.	300-350F
COOLING TRAY HIGH TEMP.	200F
DATA LOGGING VIA ARTISAN OR CROPSTER	BUILT IN DATA LOGGER ATTACHES TO COMPUTER (PC OR MAC) VIA USB OR BLUETOOTH
K TYPE THERMOCOUPLES	BT & ET WITH TWO ADDITIONAL PREDRILLED CAPPED THREADED HOLES TO ADD OR ADJUST LOCATION OF PROBES
MANUFACTURED IN CHINA FOR BC ROASTERS	CUSTOM BUILT FOR BC SPECS IN USA AND OVER 200 LANDS

FOR MORE INFORMATION SEE:

BCROASTERS.COM

HTTP://WWW.BUCKEYECOFFEE.COM/BC-COFFEE-ROASTERS.HTML

**BC ROASTERS
BUCKEYE, ARIZONA 85326
TONOPAH, ARIZONA 85354**

**TOLL FREE: 844.522.6333
INFO@BUCKEYECOFFEE.COM
INFO@BCROASTERS.COM**

BCROASTERS.COM INFO@BUCKEYECOFFEE.COM 844.522.6333