

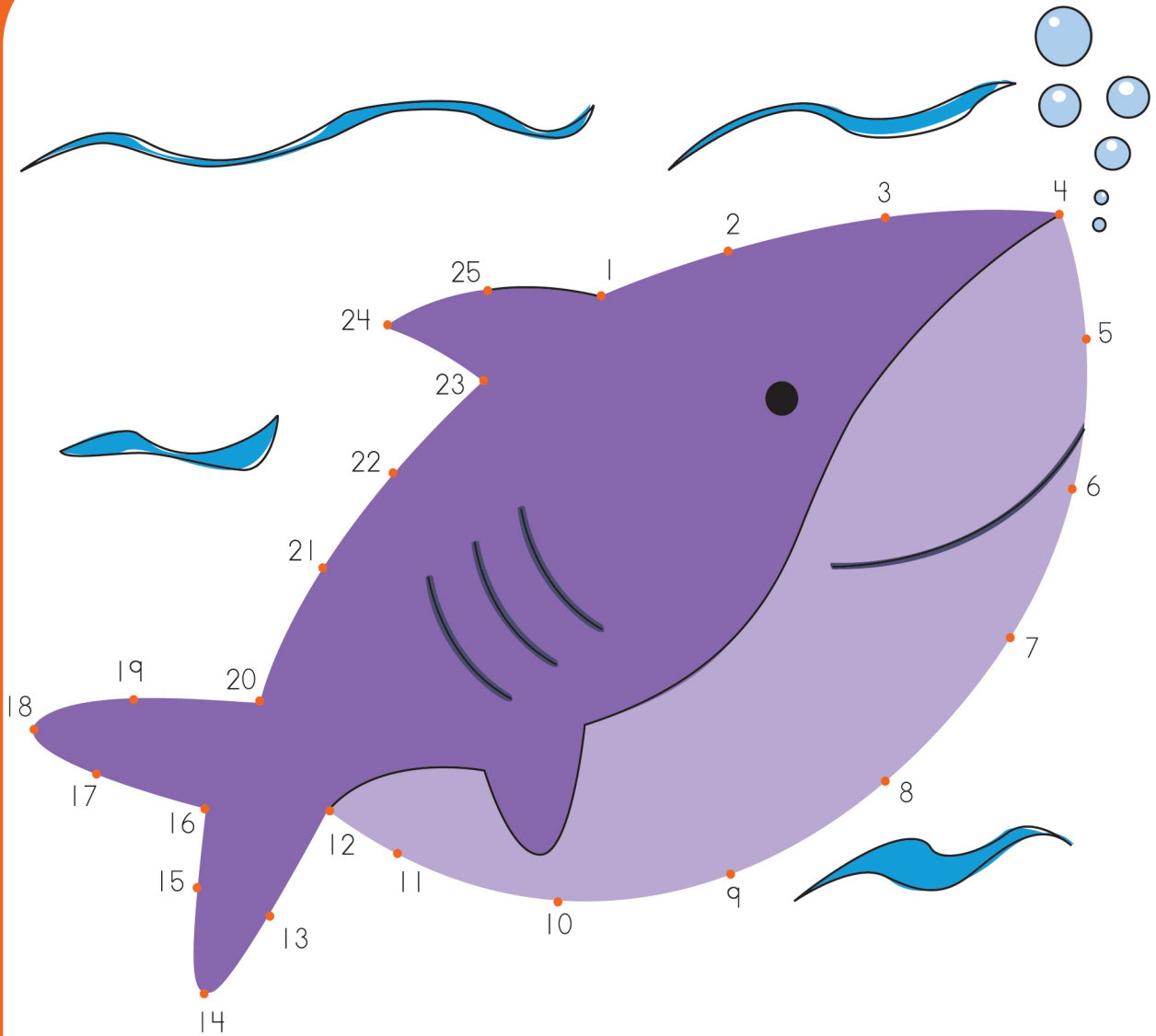

DOT-TO-DOT

PRACTICE WORKBOOK



Kids LOVE connect-the-dots activities! They aren't just fun, they are also great educational tools. Tracing and counting are excellent ways to develop the fine motor skills kids need for kindergarten and grade one! The Ready to Learn™ Dot-To-Dot Practice Workbook is an engaging supplement to the Ready to Learn™ Kindergarten and Grade One workbooks and workpads. This book makes learning fun and reinforces the skills necessary for success in counting and fine motor skills all through fun connect-the-dots activities!

Connect the dots to complete the picture. Then trace the word and colour the picture.

CHICK

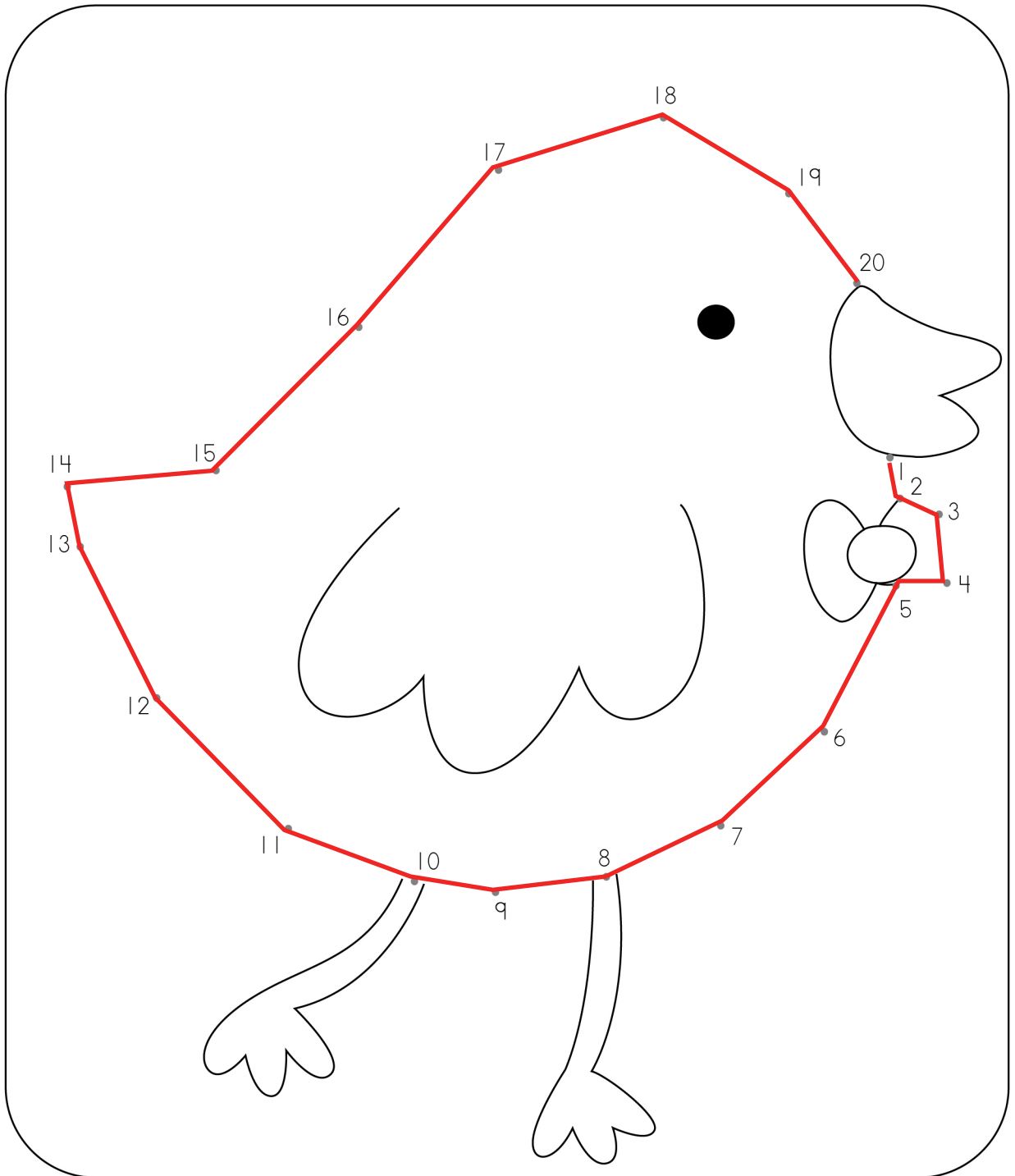

Connect the dots to complete the picture. Then trace the word and colour the picture.

DOLPHIN

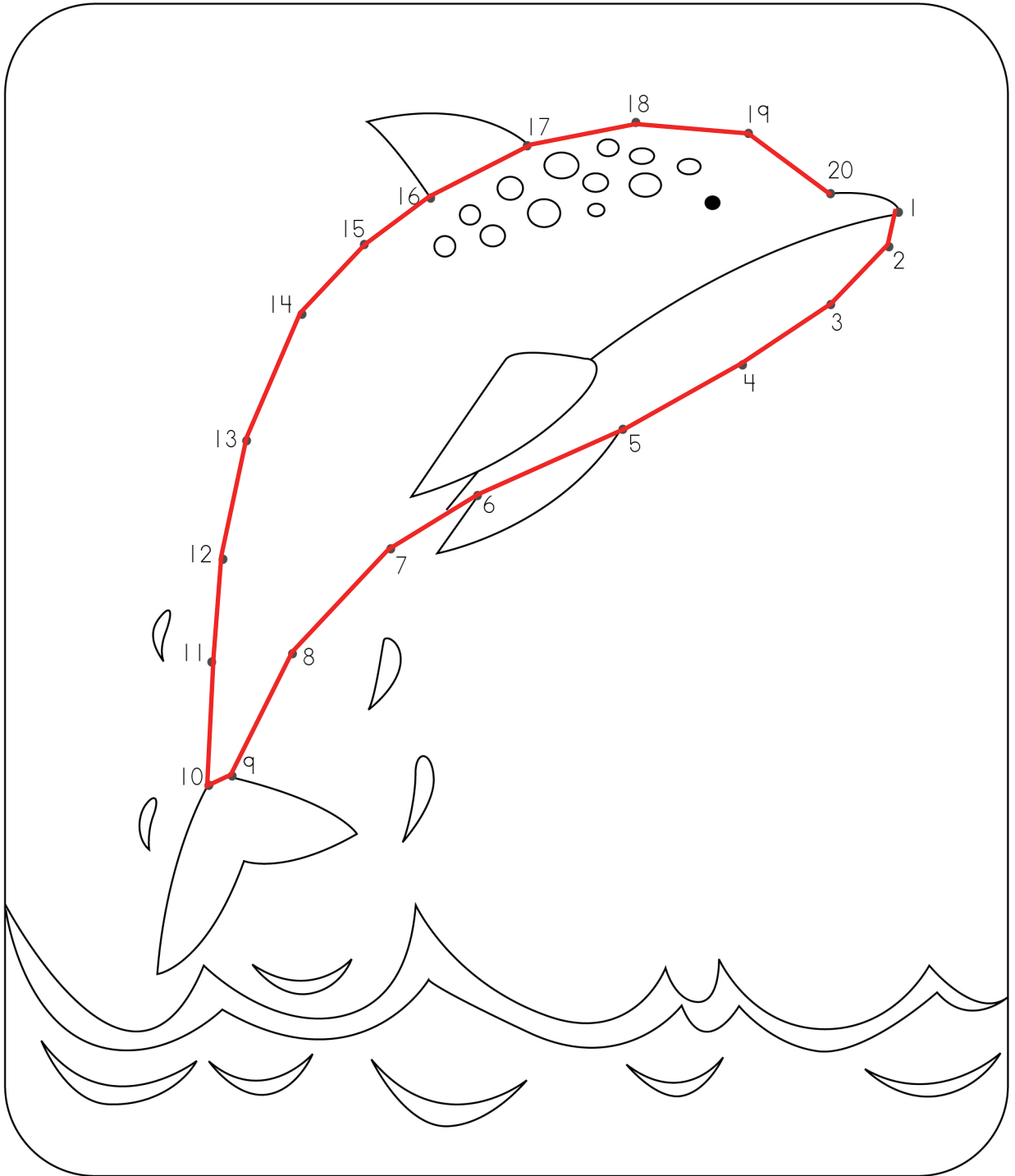

Connect the dots to complete the picture. Then trace the word and colour the picture.

HELICOPTER

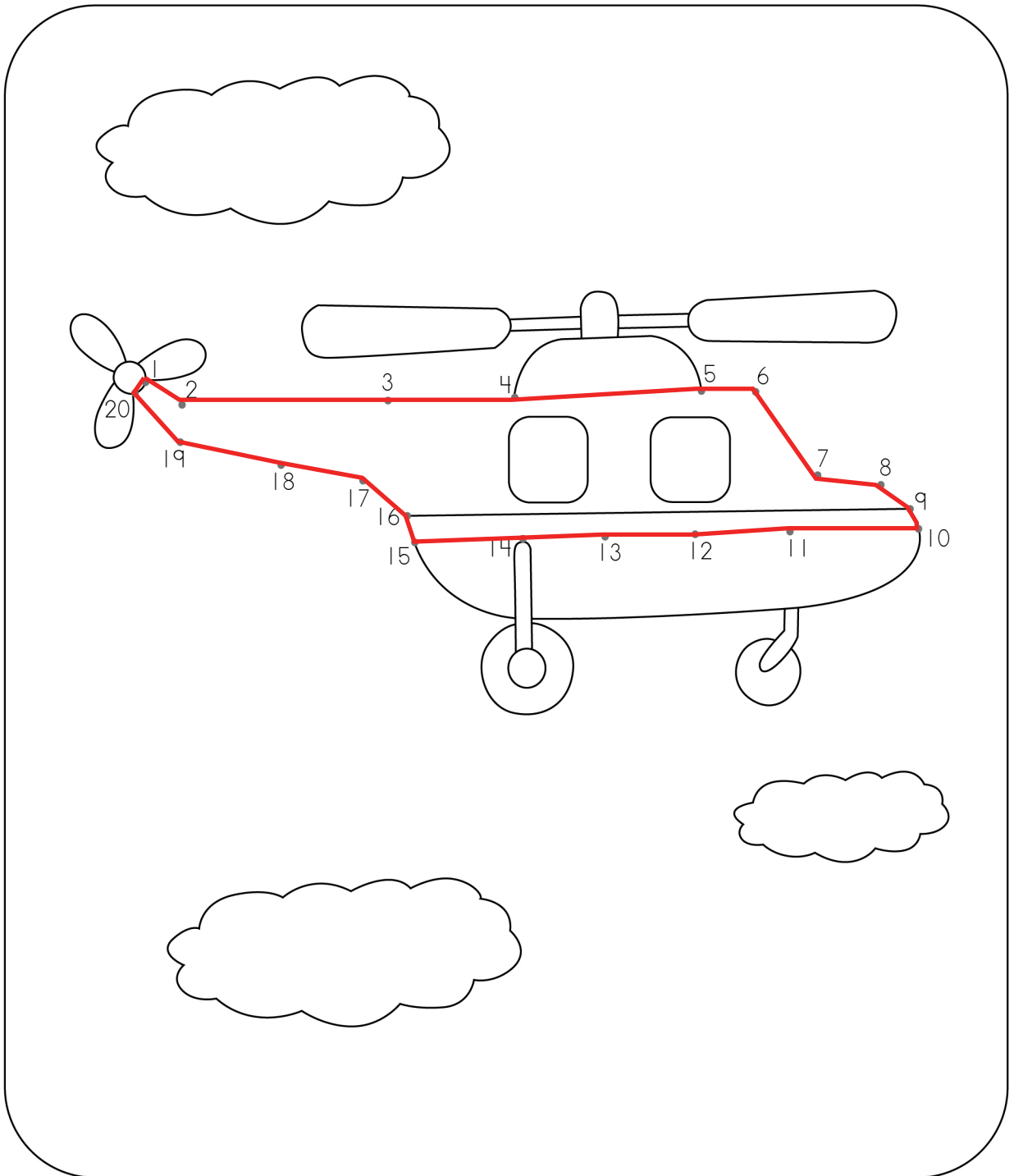

Connect the dots to complete the picture. Then trace the word and colour the picture.

GERBIL

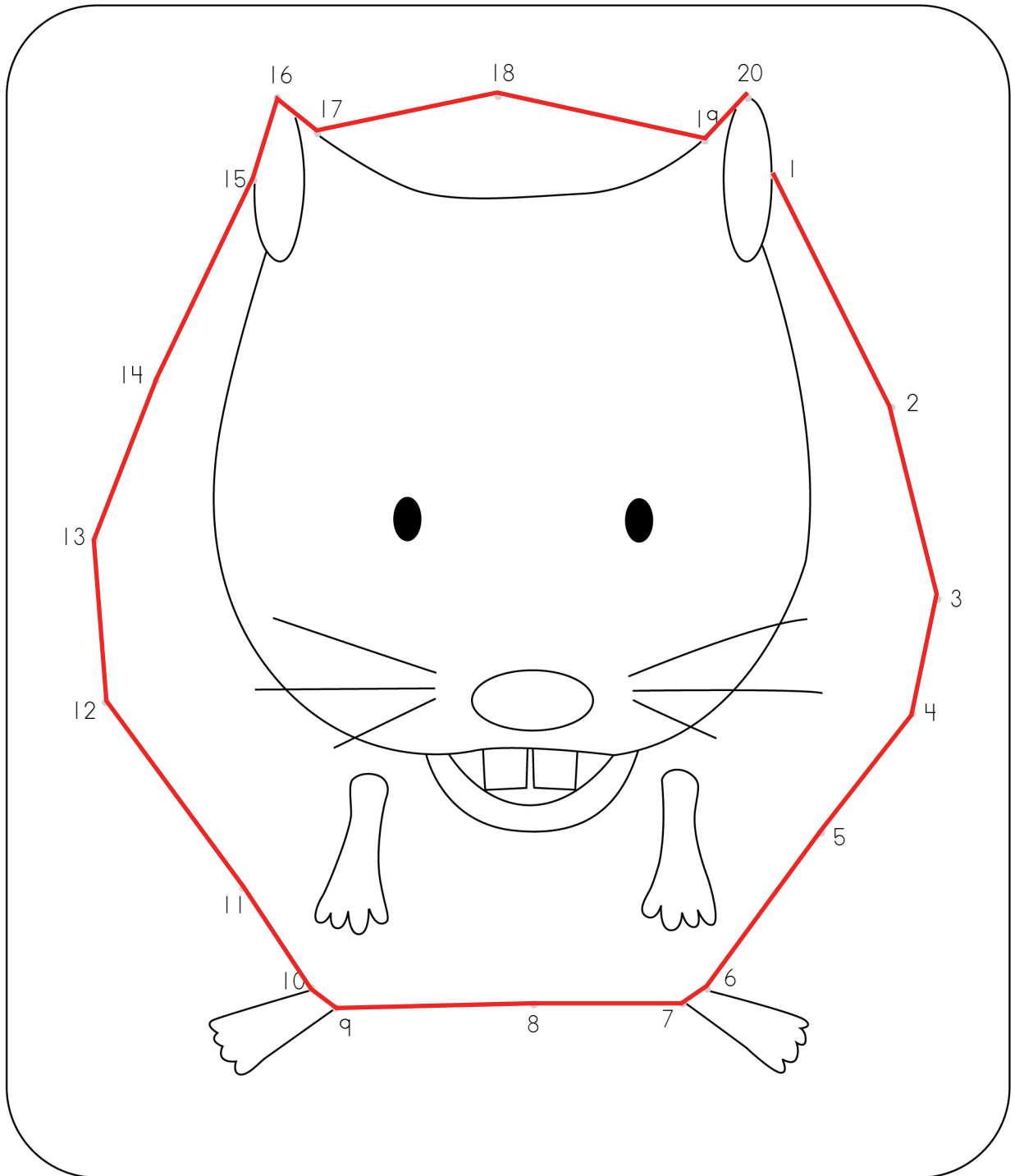

Connect the dots to complete the picture. Then trace the word and colour the picture.

PARROT

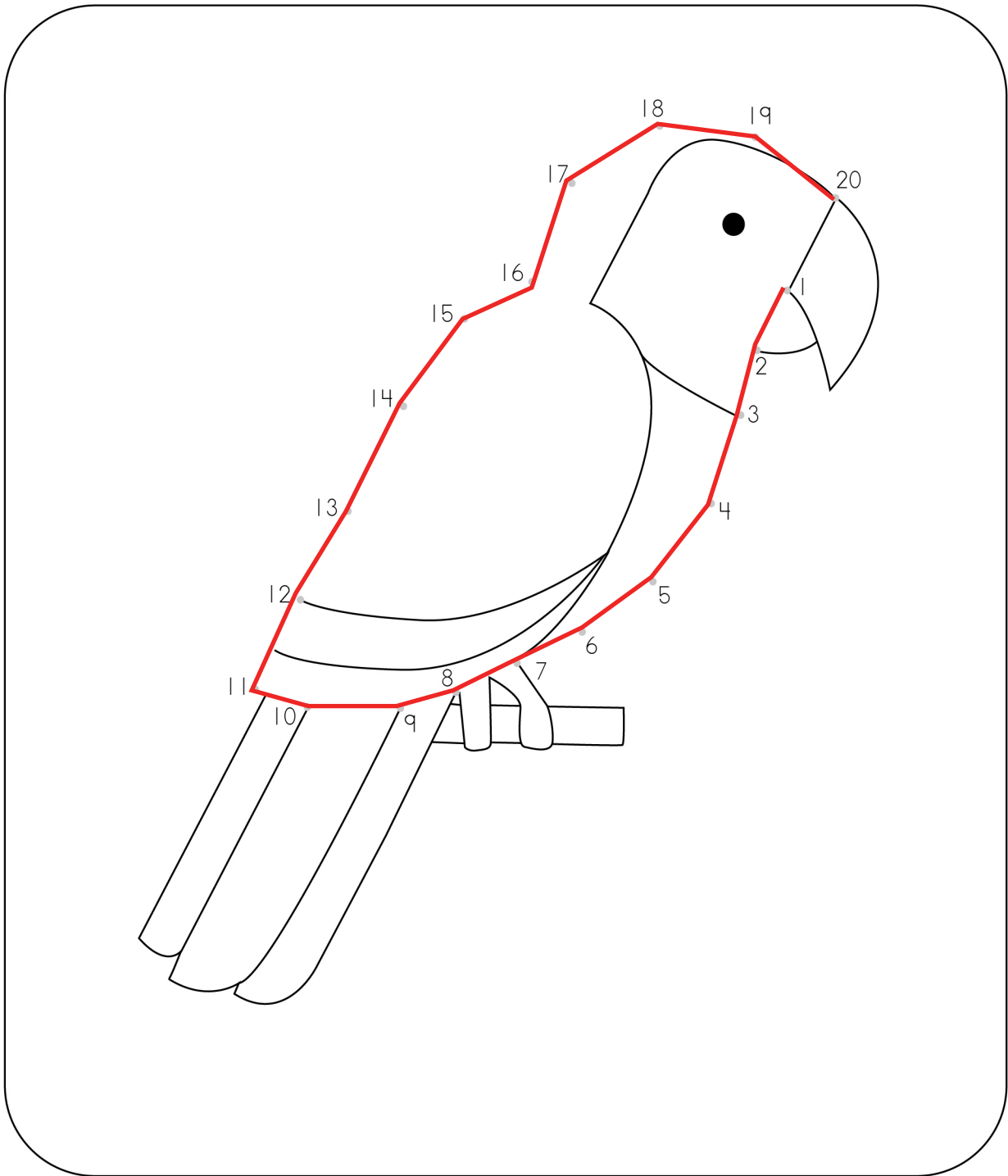

Connect the dots to complete the picture. Then trace the word and colour the picture.

SEASHELL

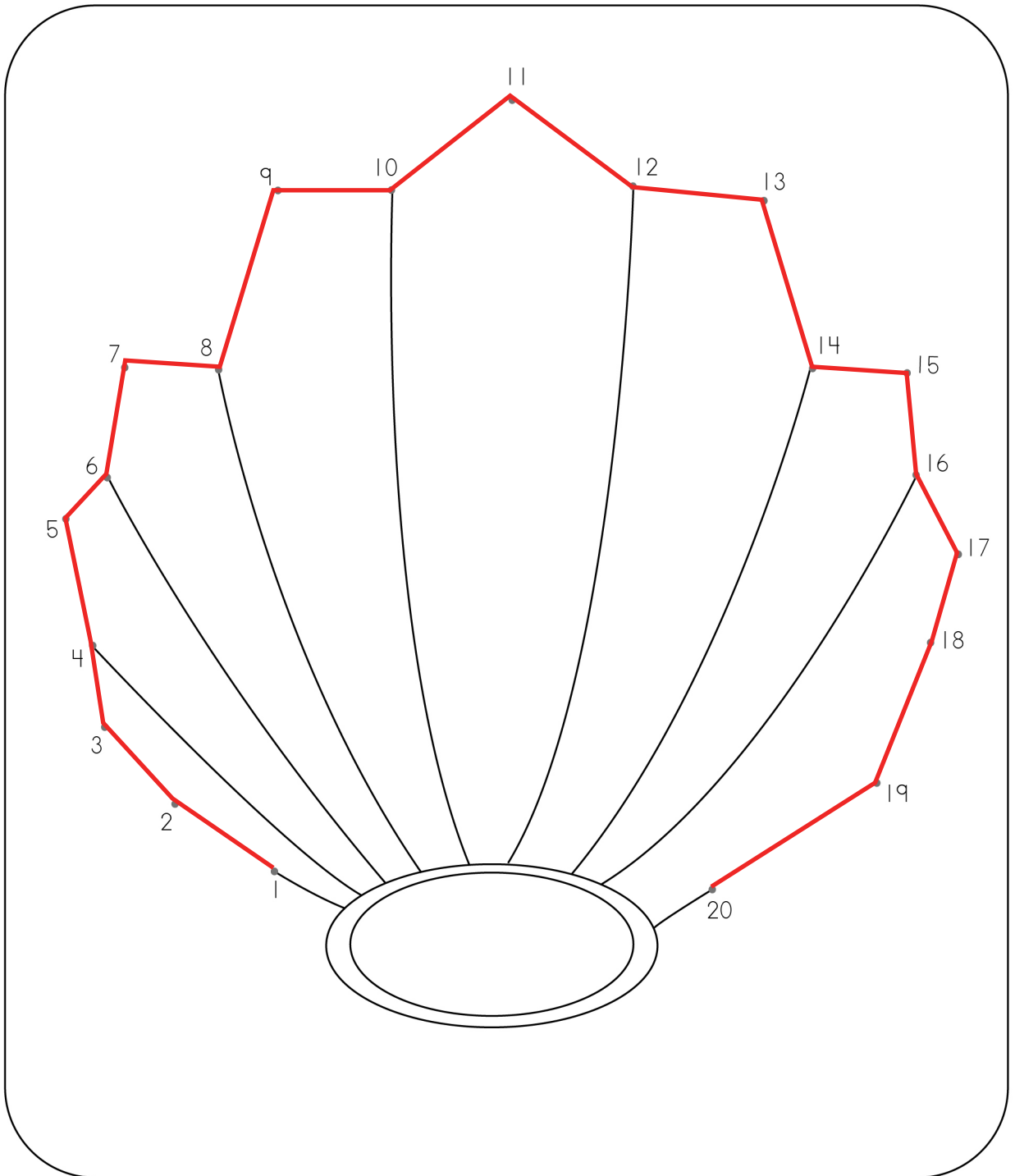

Connect the dots to complete the picture. Then trace the word and colour the picture.

TRUCK

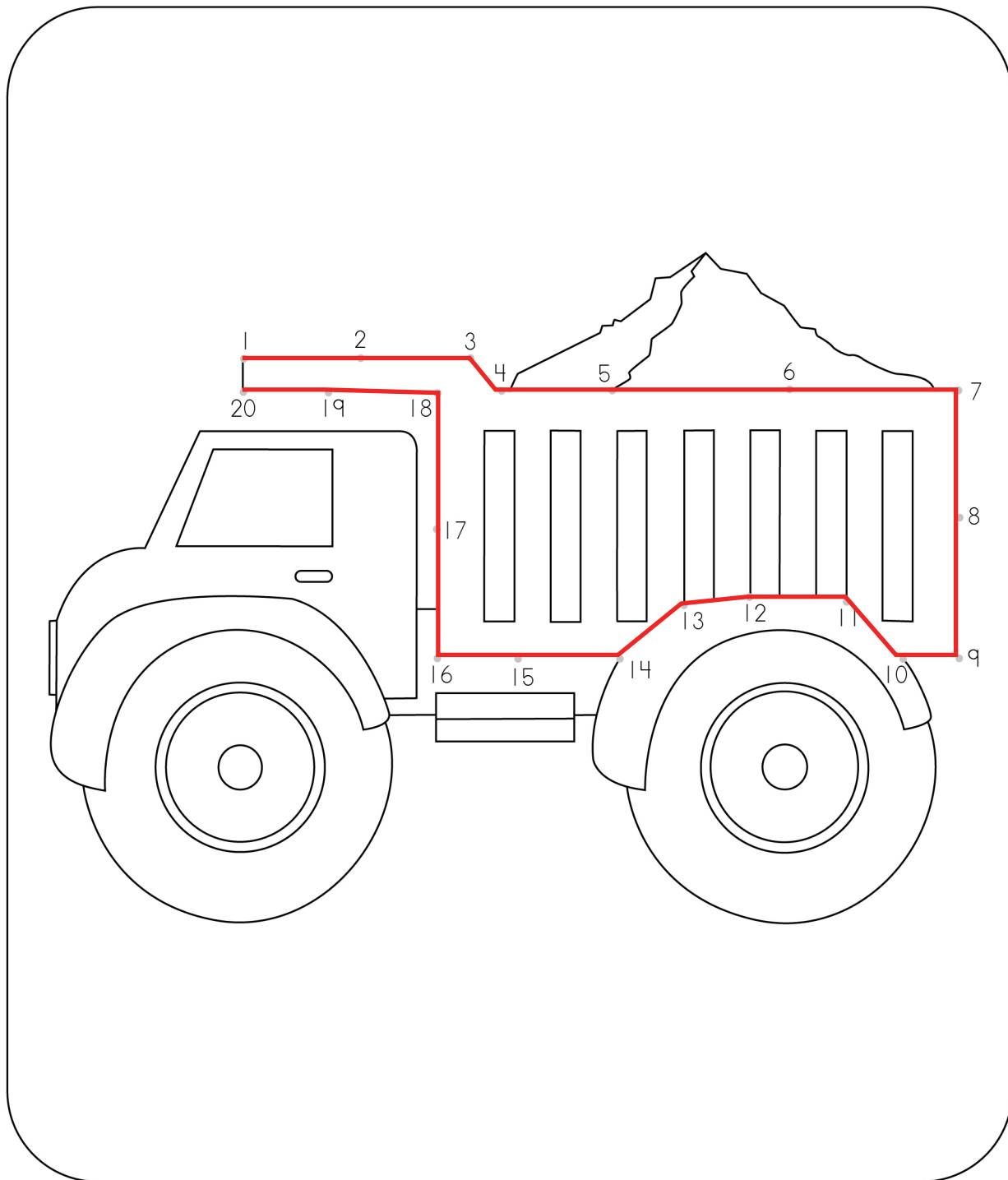

Connect the dots to complete the picture. Then trace the word and colour the picture.

CAR

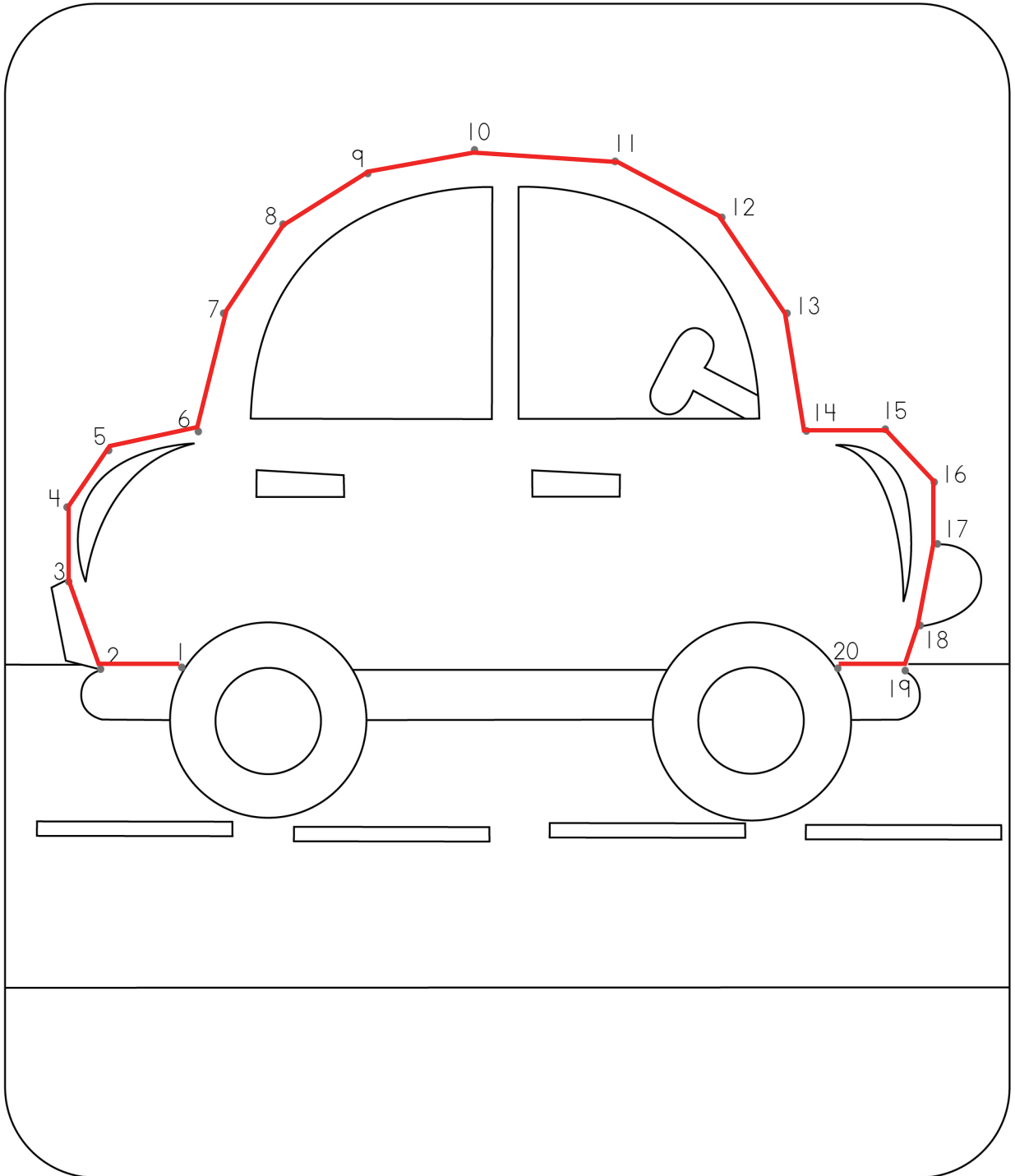

Connect the dots to complete the picture. Then trace the word and colour the picture.

CRAB

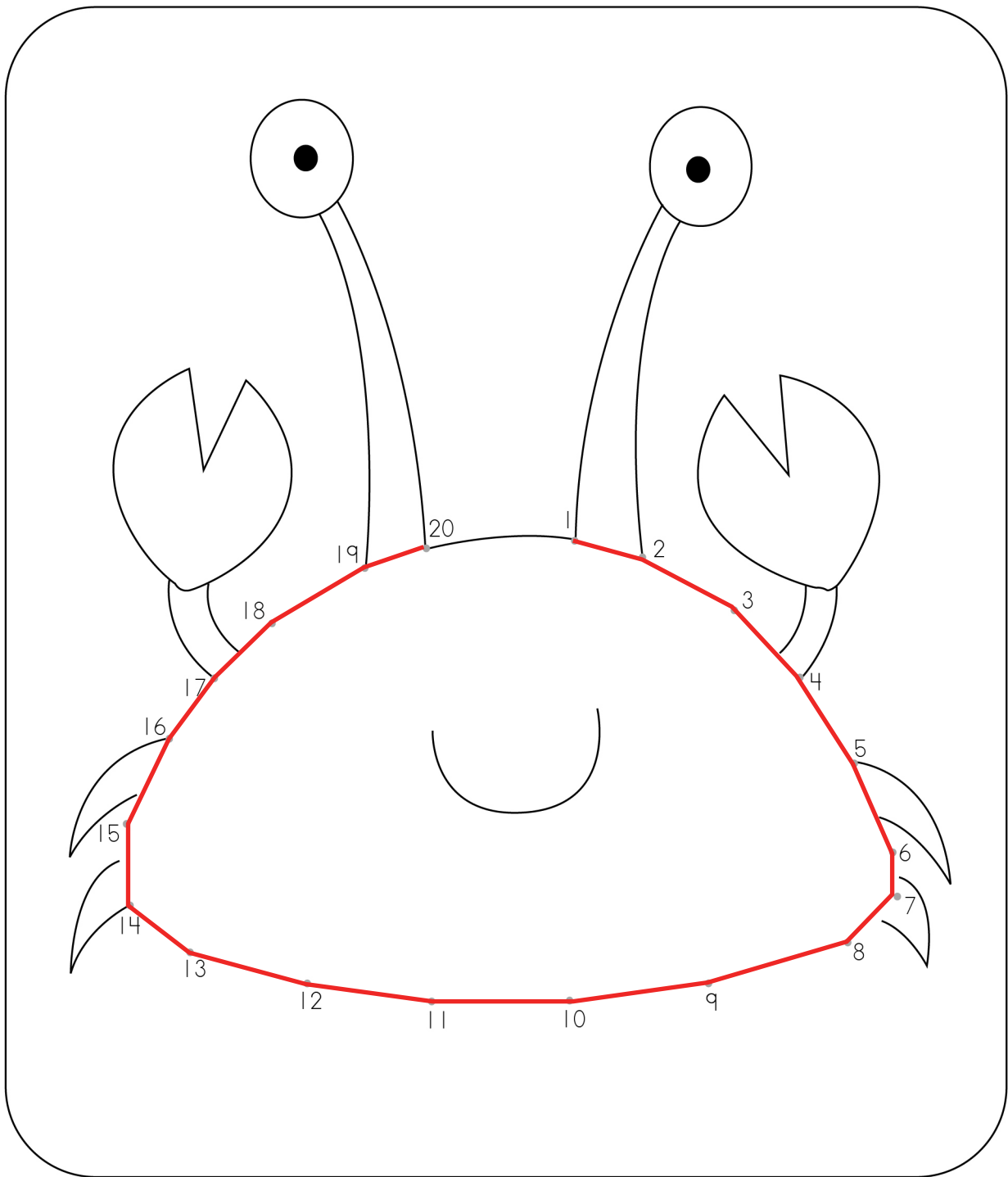

Connect the dots to complete the picture. Then trace the word and colour the picture.

FROG

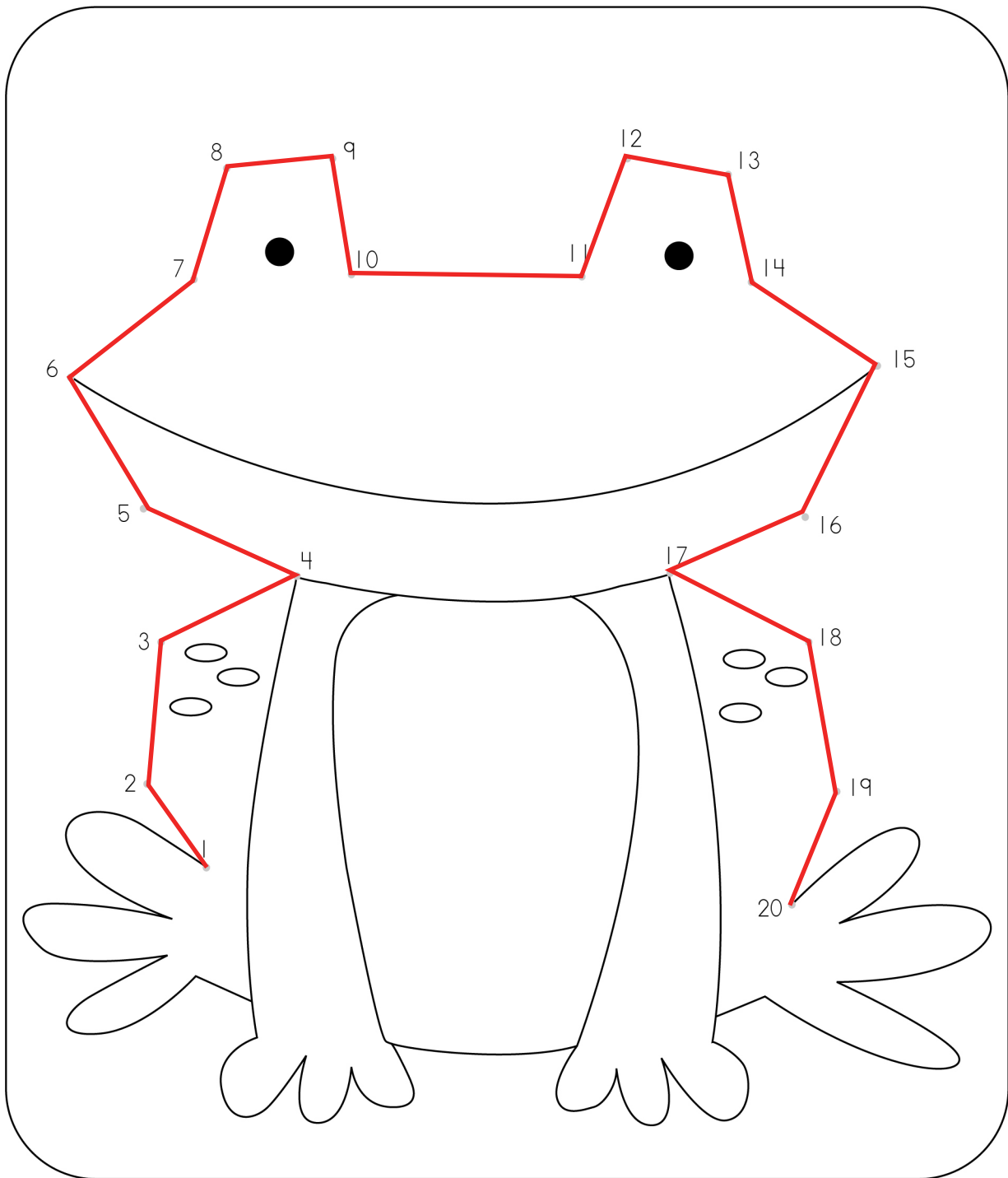

Connect the dots to complete the picture. Then trace the word and colour the picture.

GOLDFISH

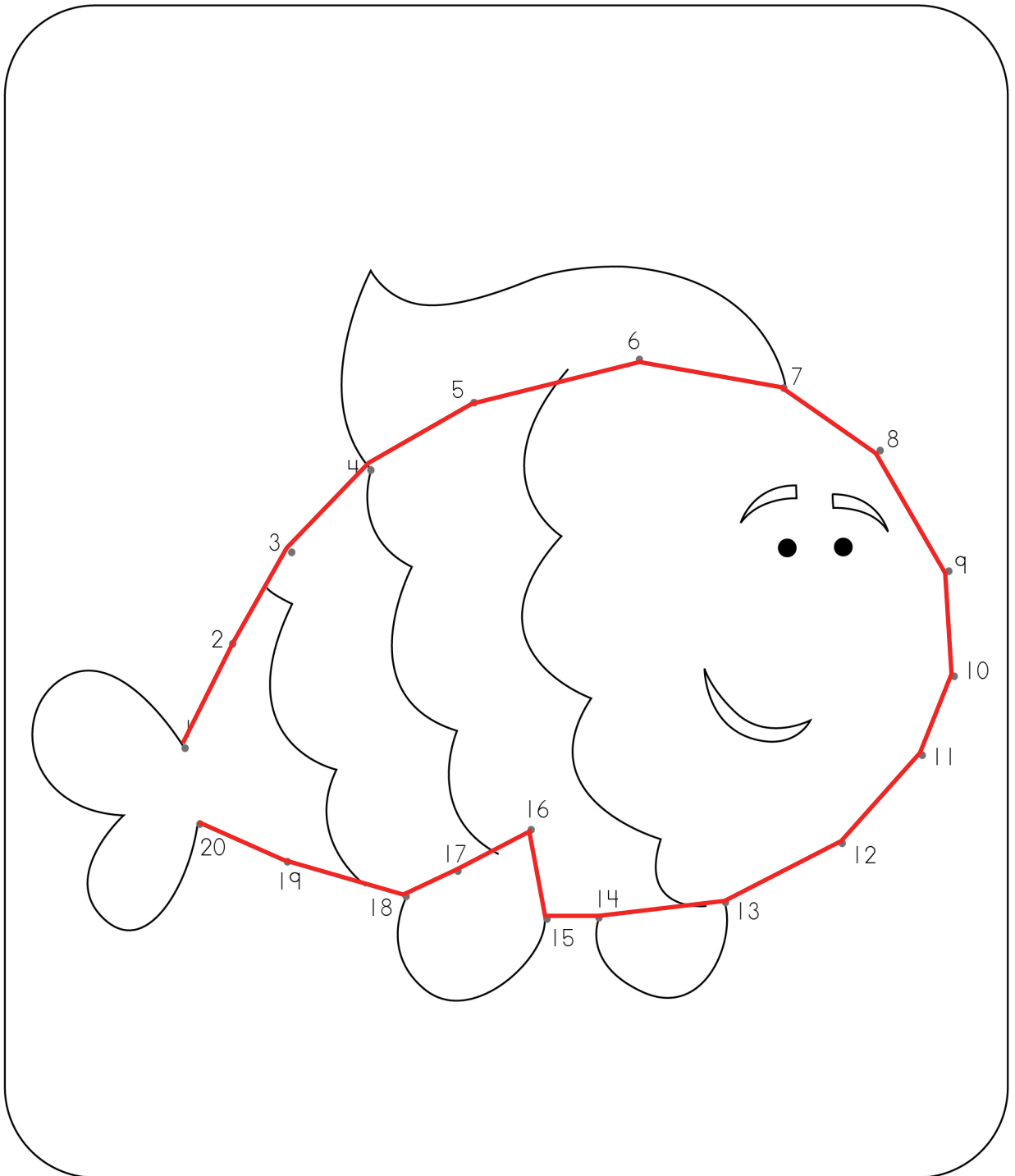

Connect the dots to complete the picture. Then trace the word and colour the picture.

JELLYFISH

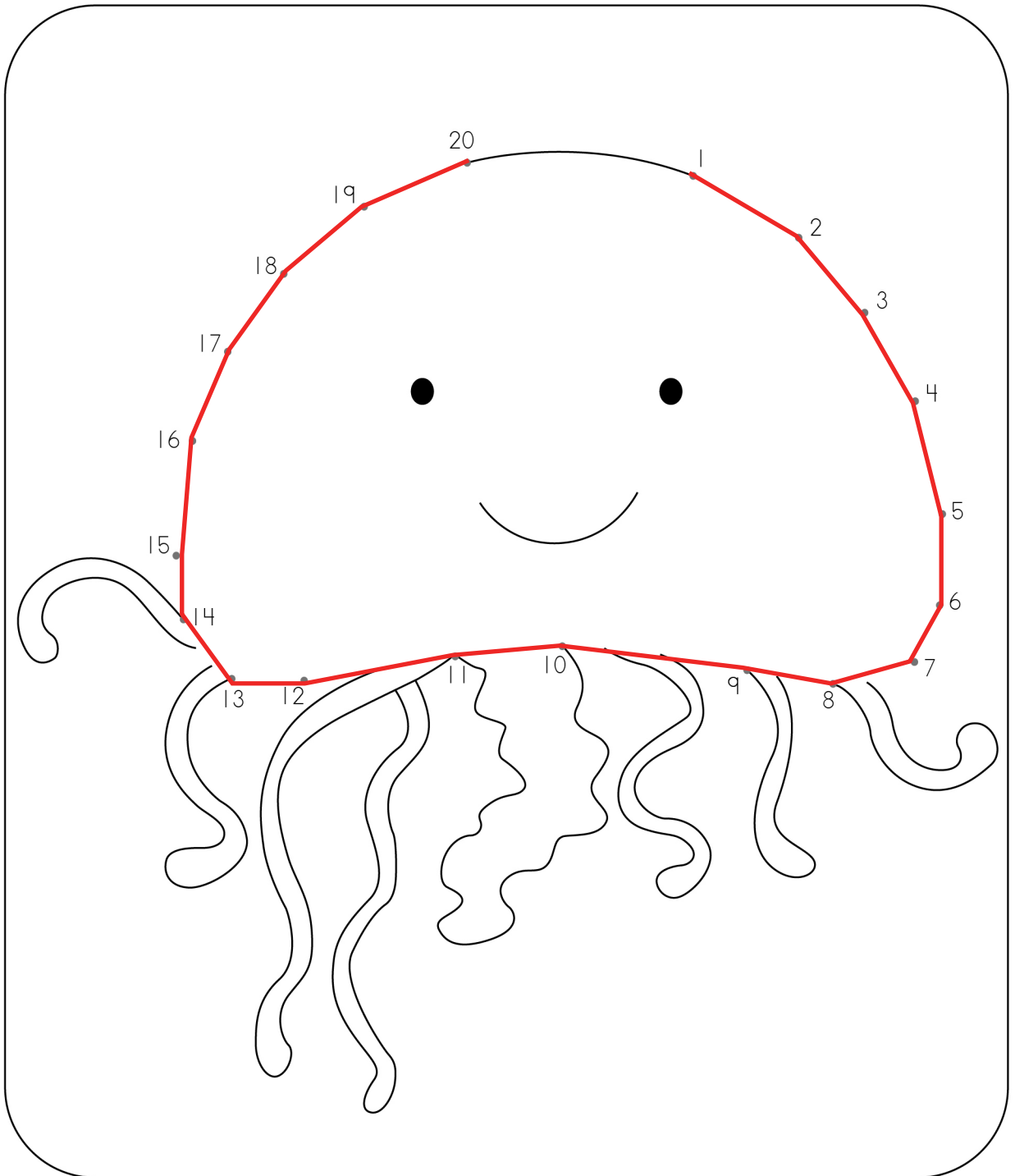

Connect the dots to complete the picture. Then trace the word and colour the picture.

OCTOPUS

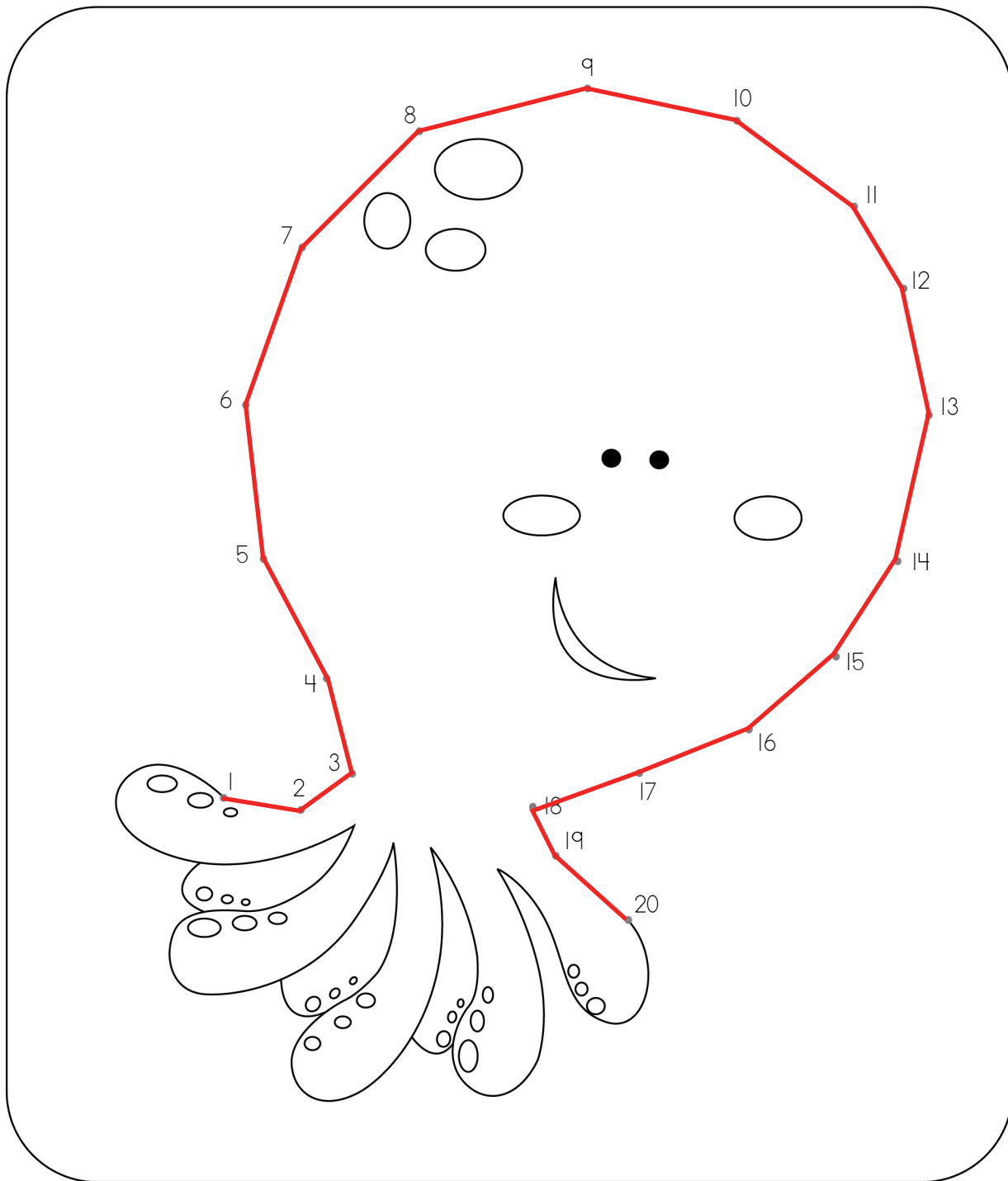

Connect the dots to complete the picture. Then trace the word and colour the picture.

DUCK

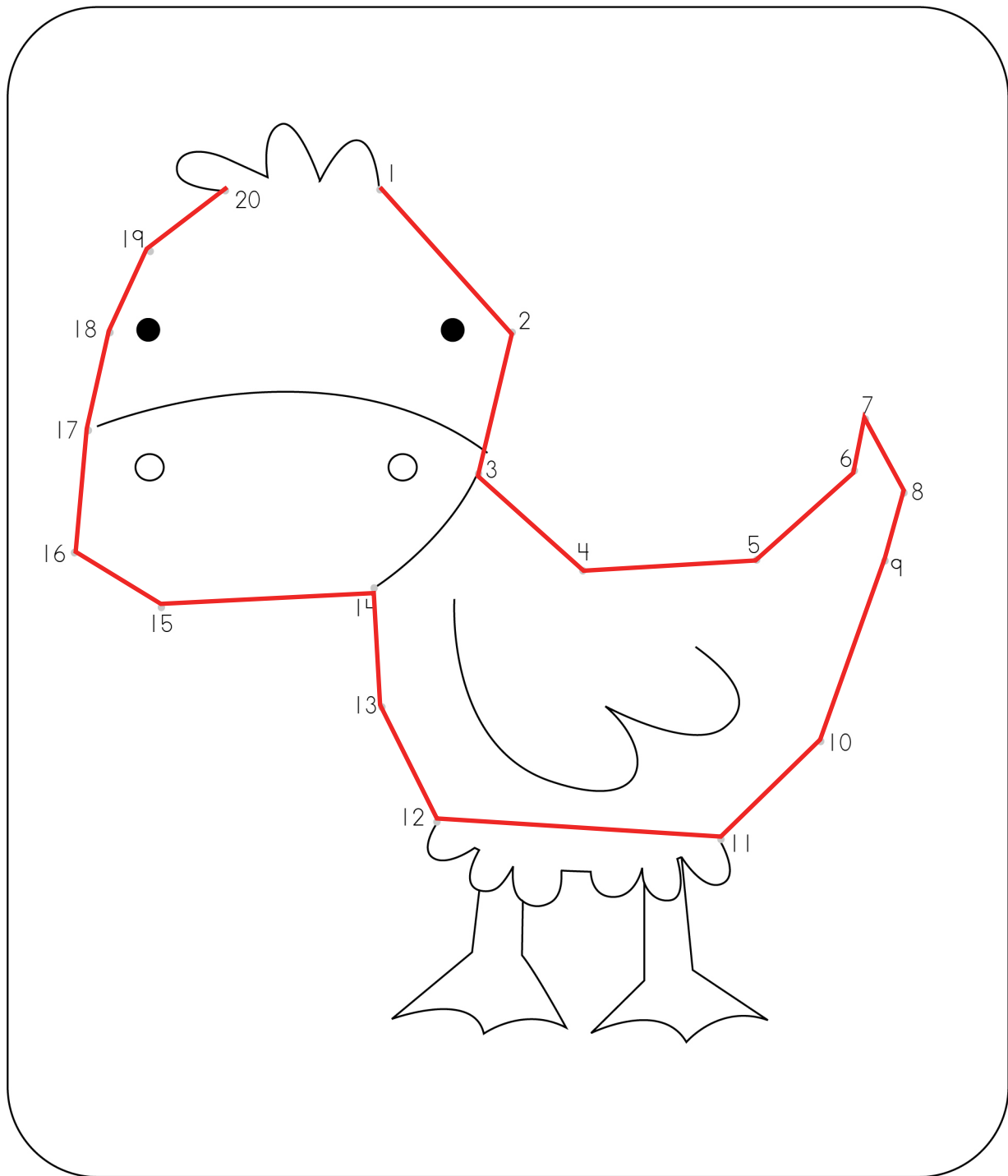

Connect the dots to complete the picture. Then trace the word and colour the picture.

bee

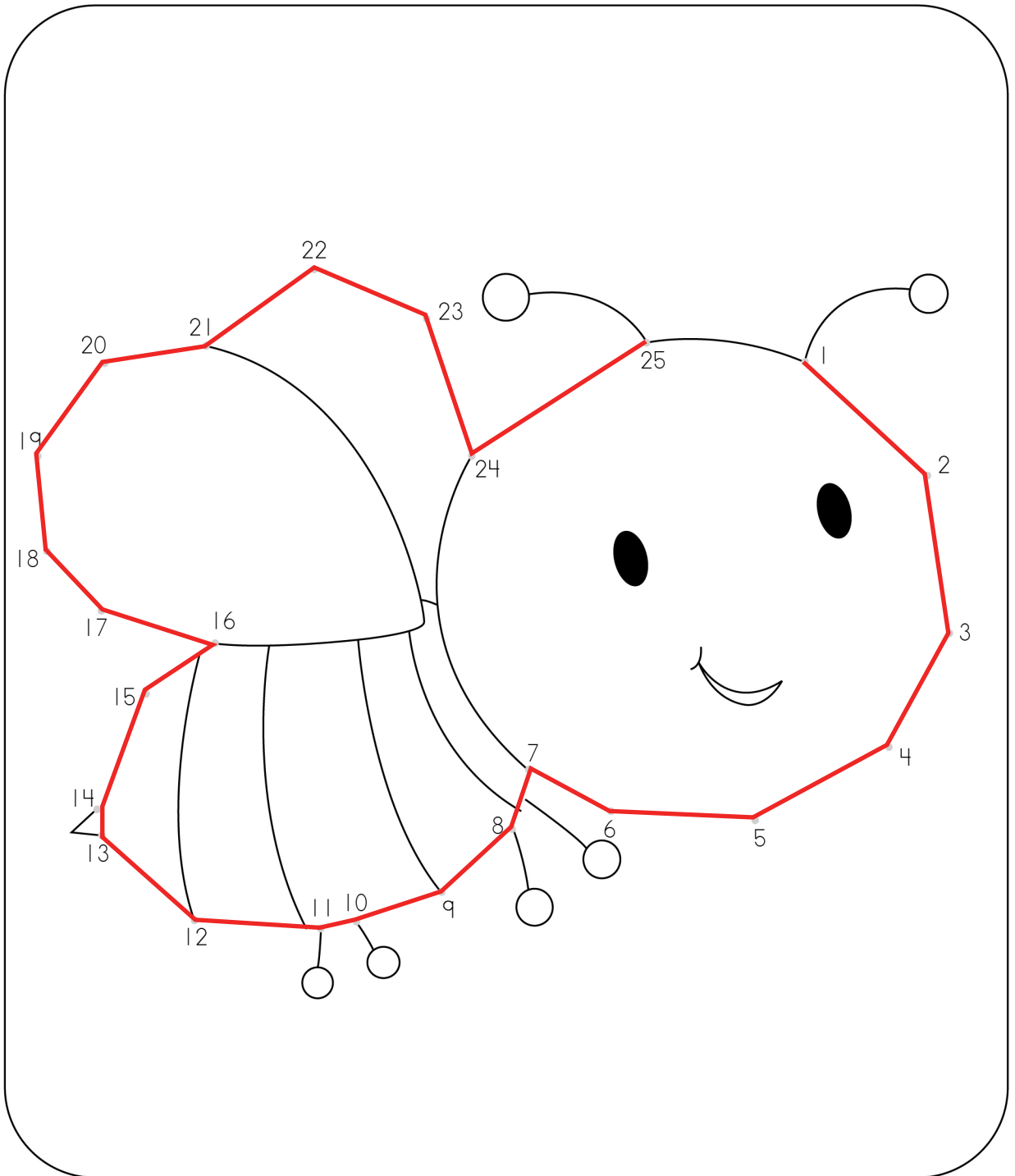

Connect the dots to complete the picture. Then trace the word and colour the picture.

chicken

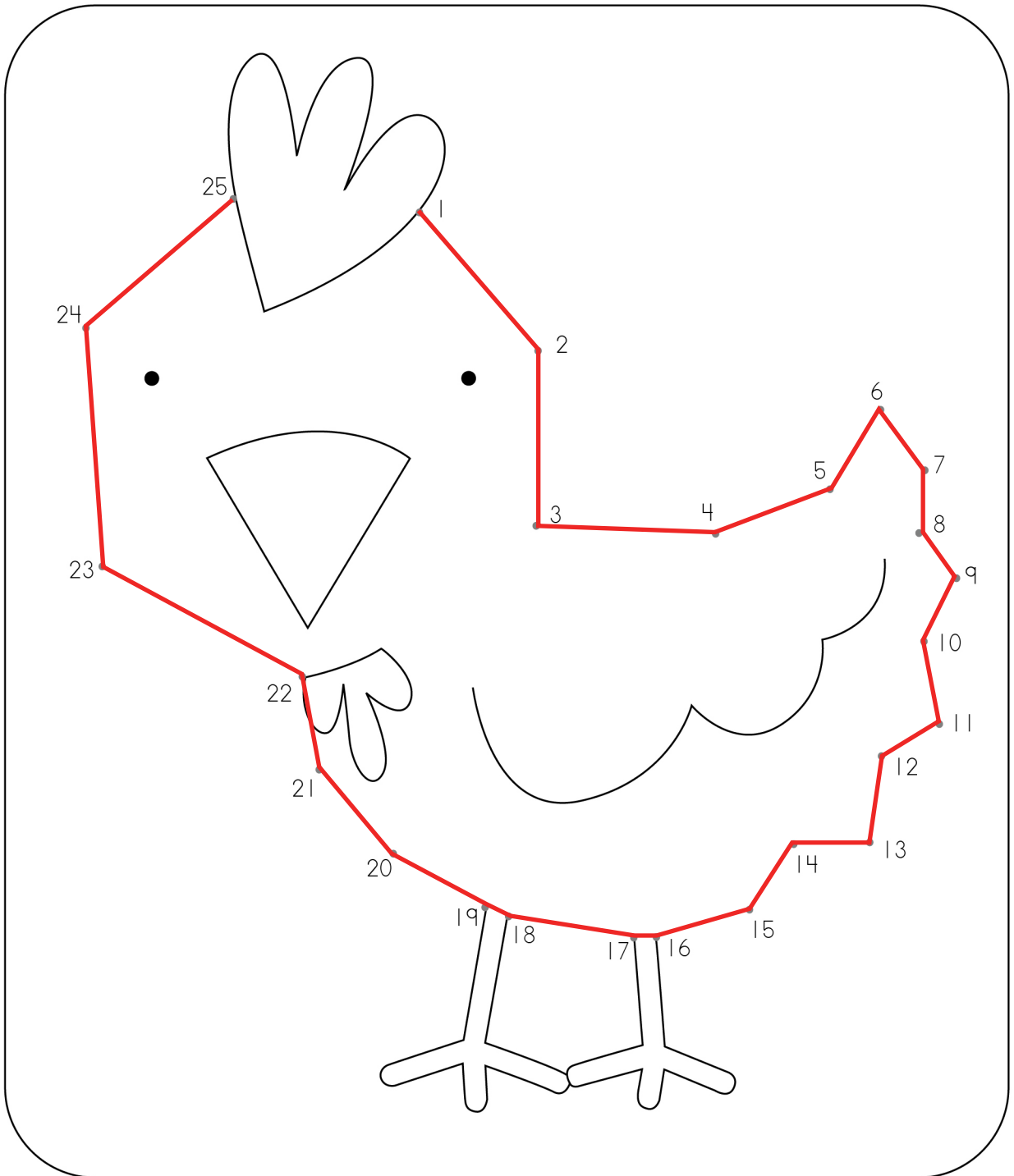

Connect the dots to complete the picture. Then trace the word and colour the picture.

COW

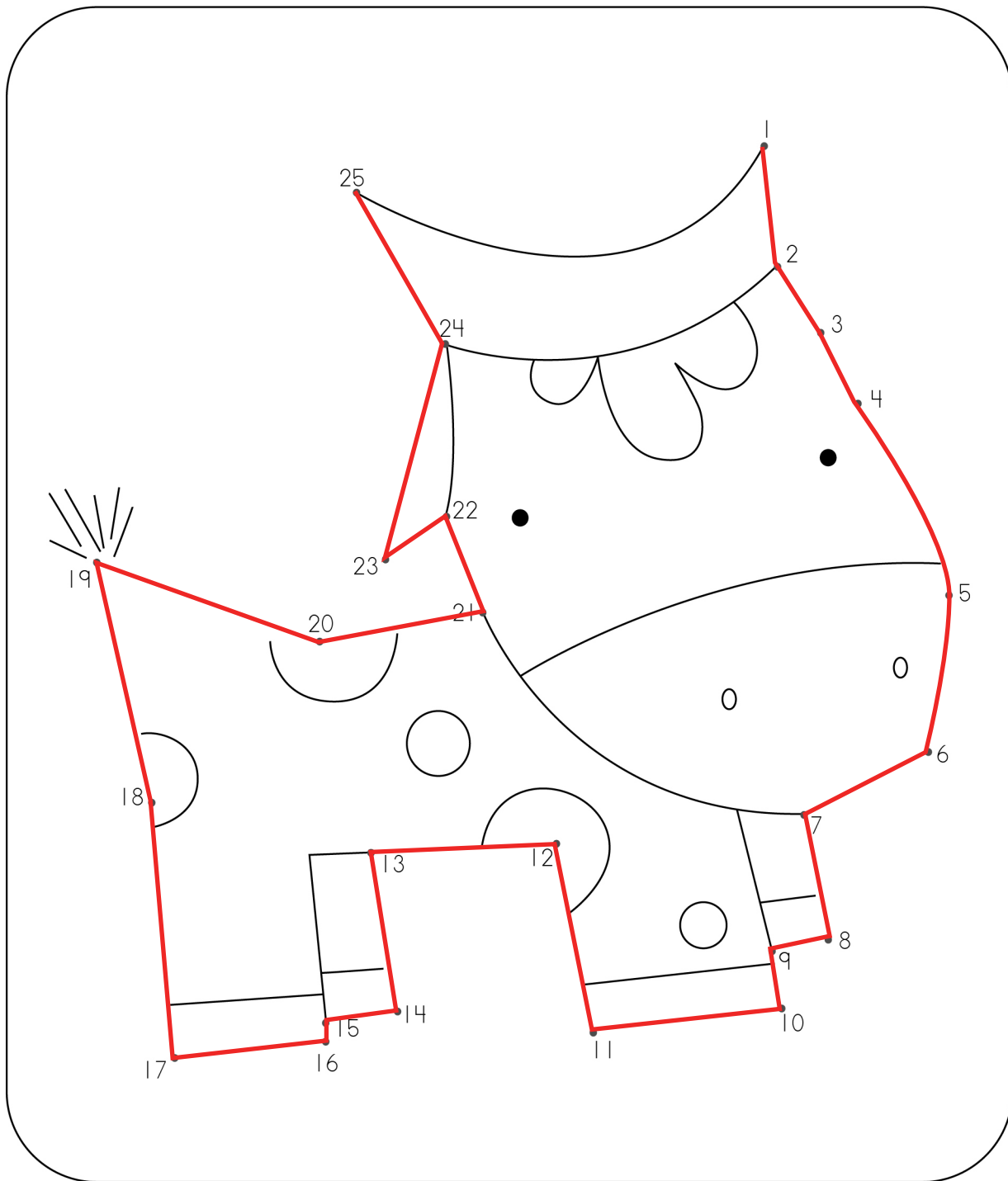

Connect the dots to complete the picture. Then trace the word and colour the picture.

sheep

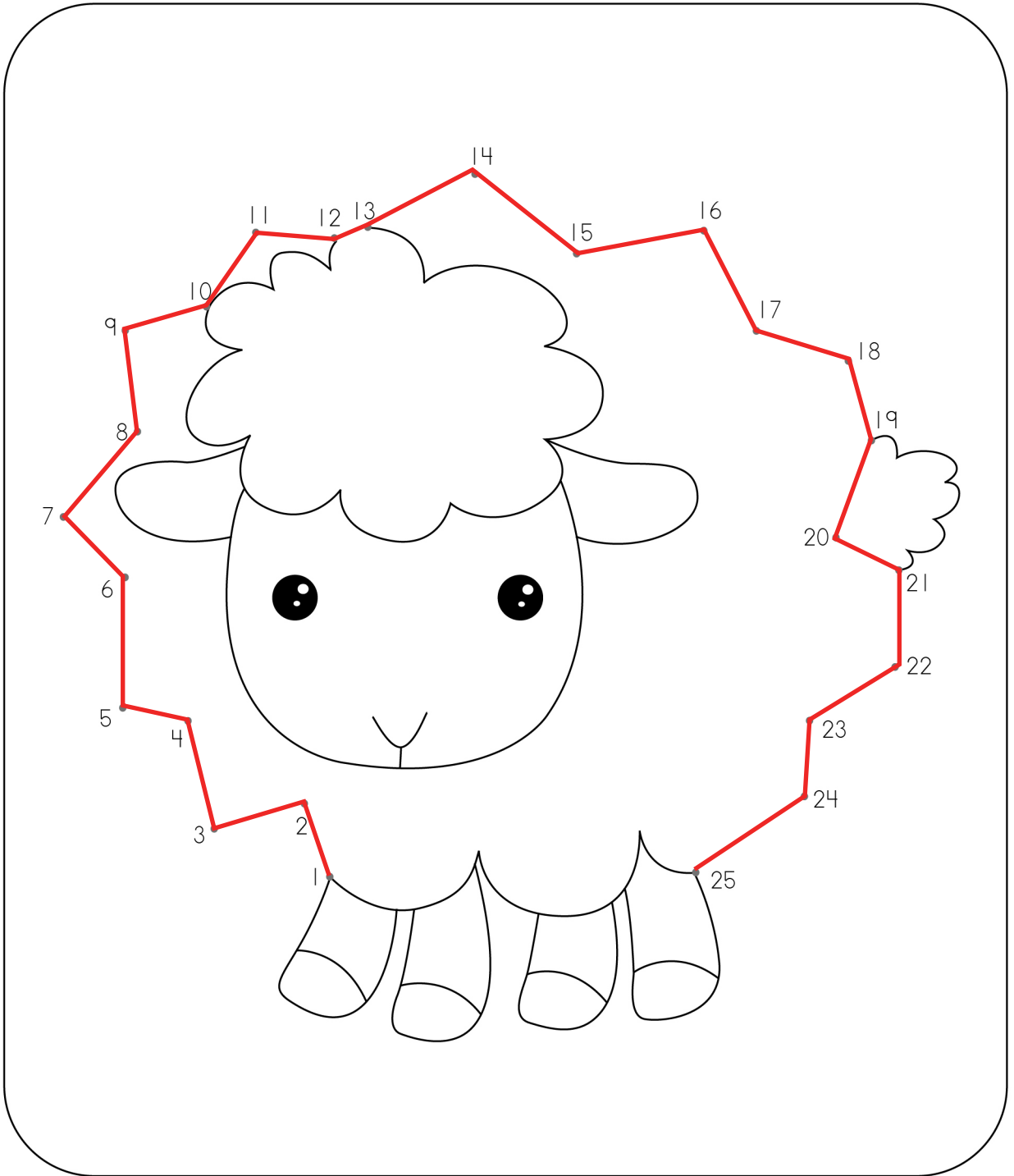

Connect the dots to complete the picture. Then trace the word and colour the picture.

snail

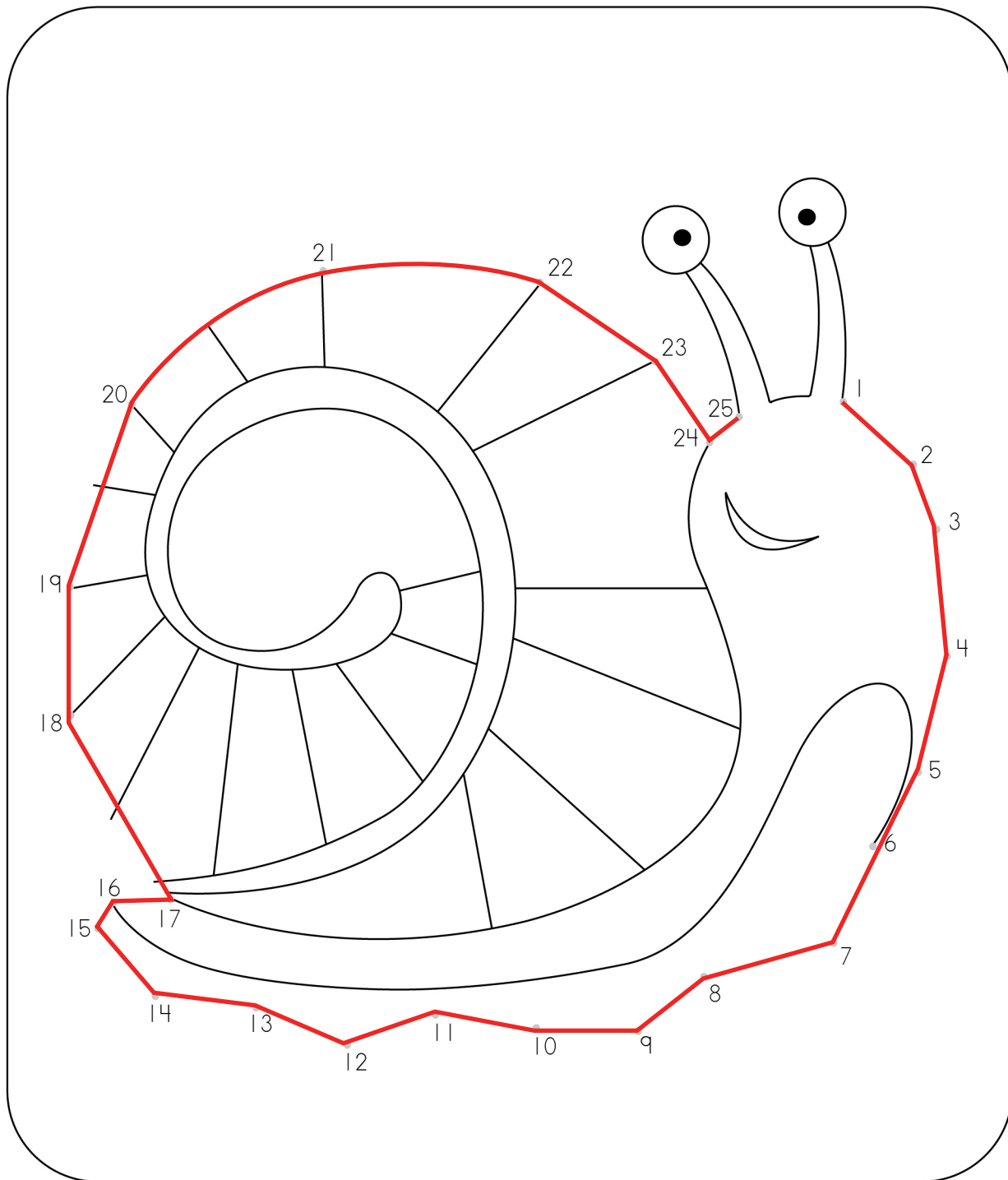

Connect the dots to complete the picture. Then trace the word and colour the picture.

motorcycle

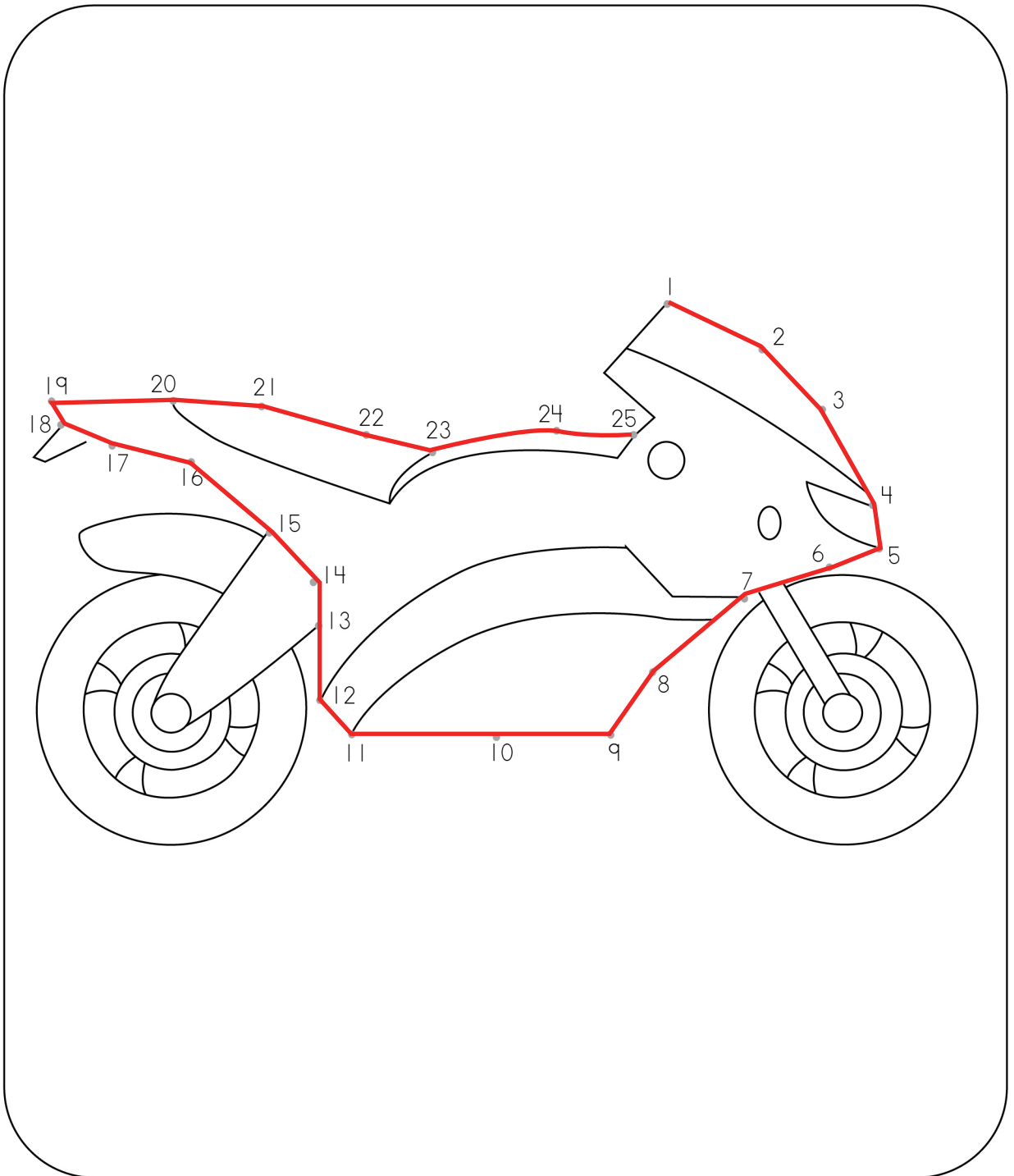

Connect the dots to complete the picture. Then trace the word and colour the picture.

caterpillar

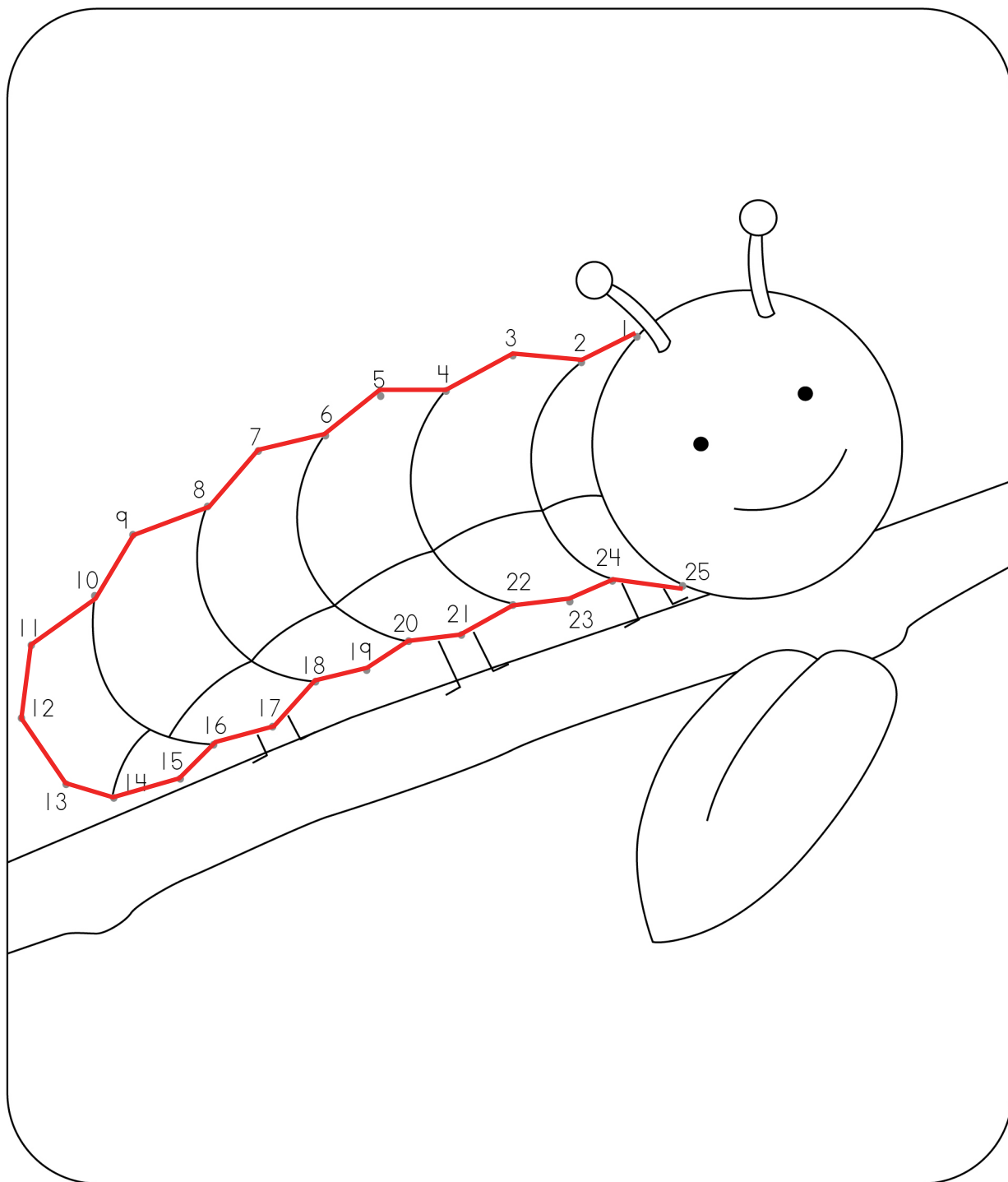

Connect the dots to complete the picture. Then trace the word and colour the picture.

clownfish

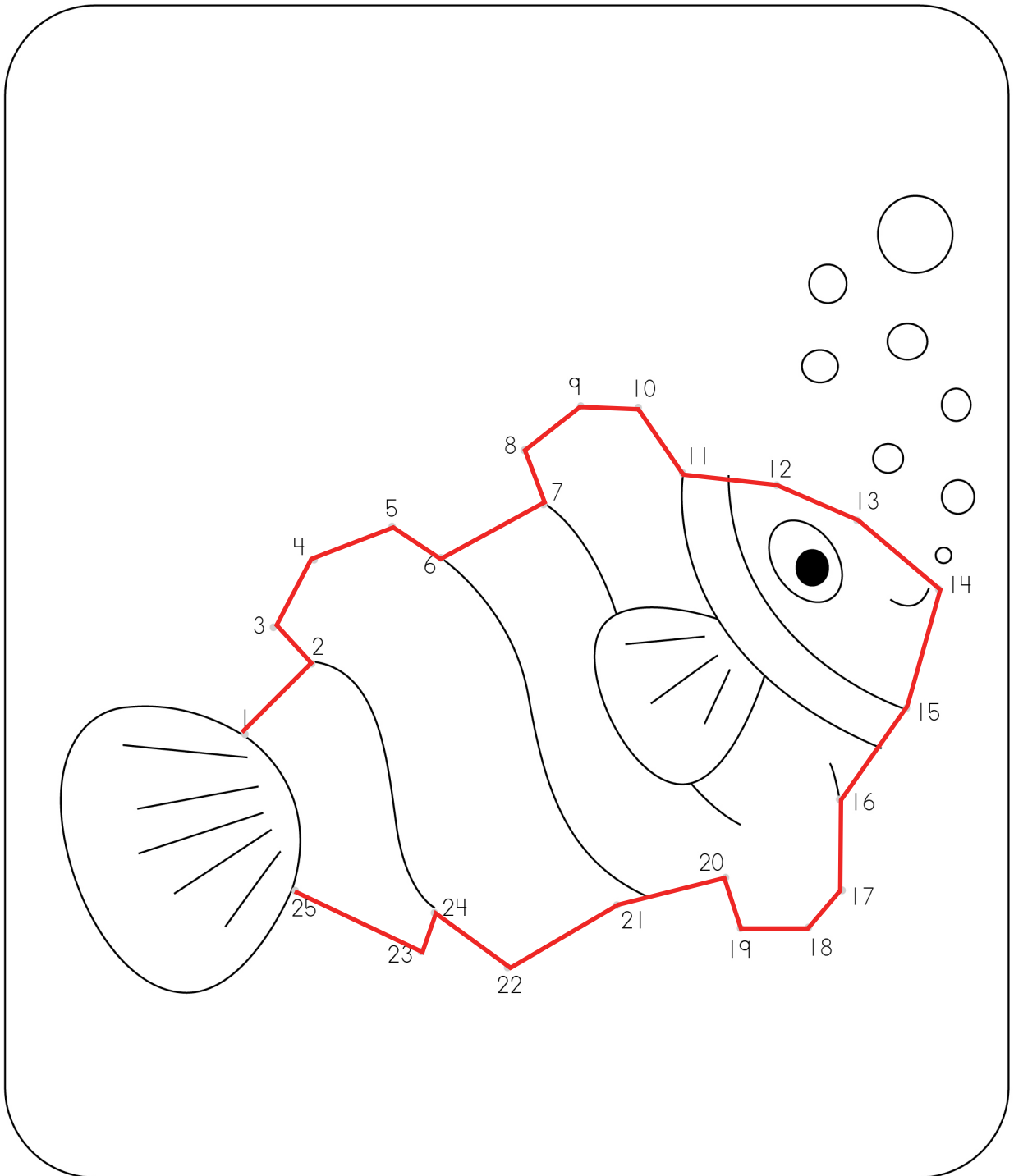

Connect the dots to complete the picture. Then trace the word and colour the picture.

flower

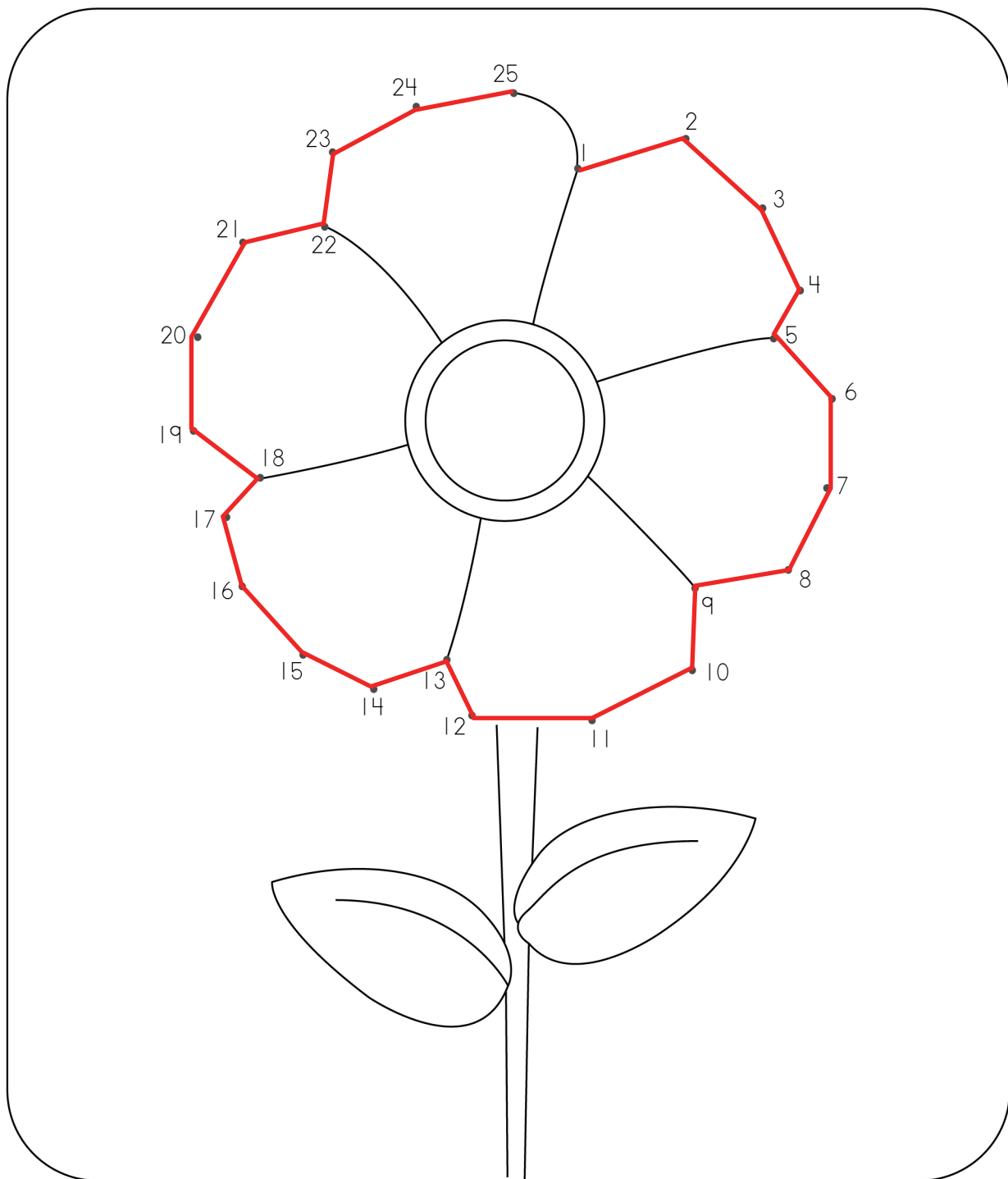

Connect the dots to complete the picture. Then trace the word and colour the picture.

giraffe

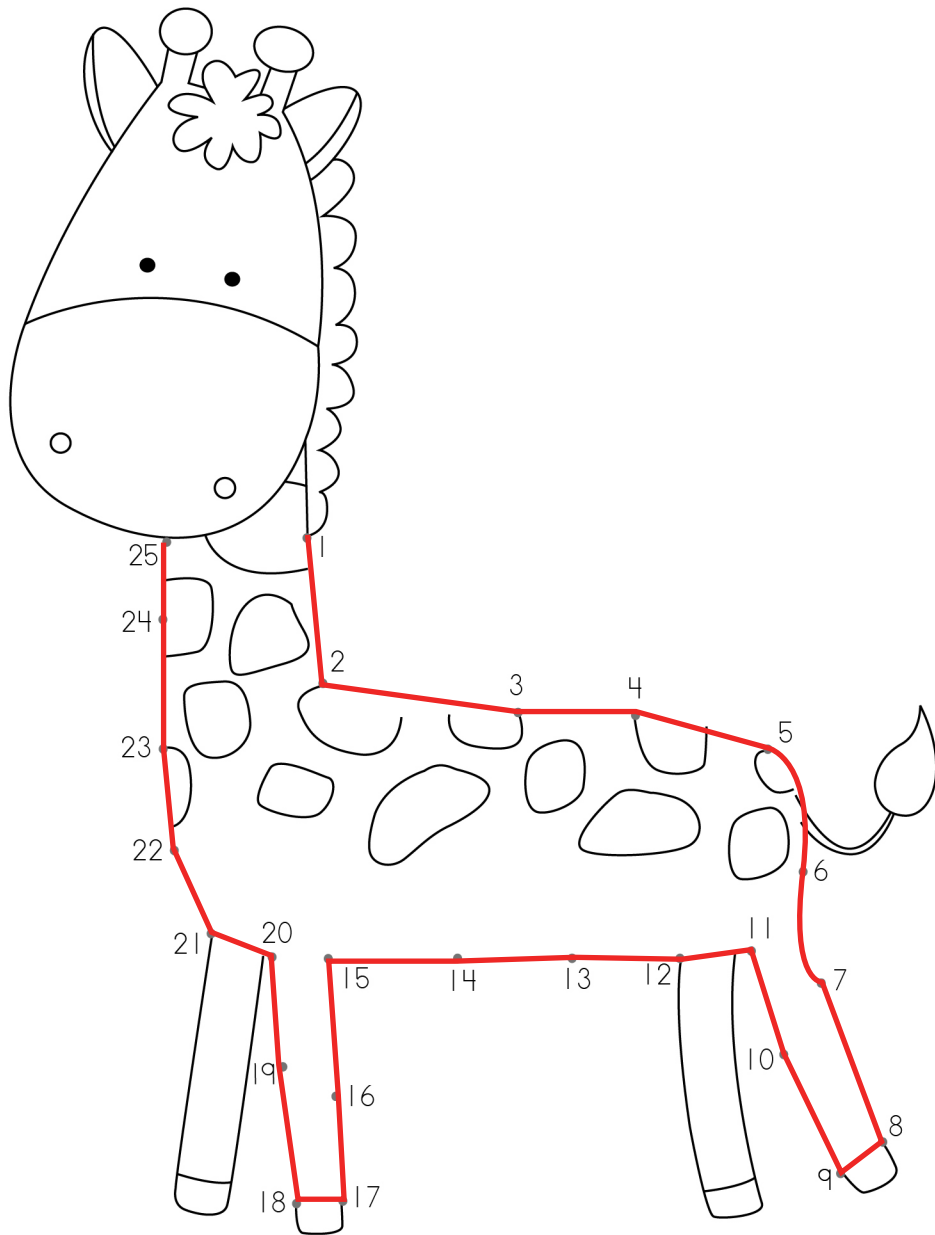

Connect the dots to complete the picture. Then trace the word and colour the picture.

monkey

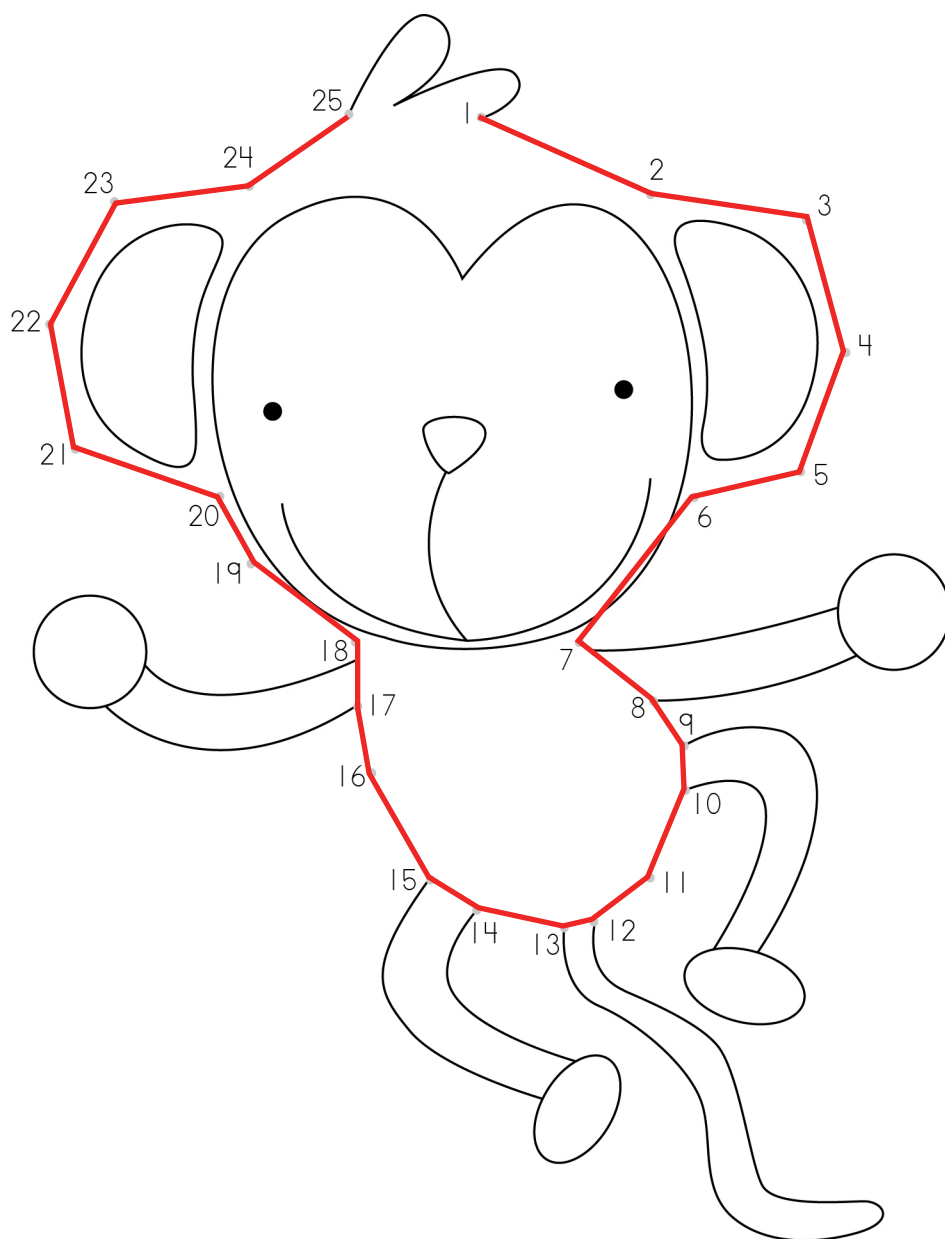

Connect the dots to complete the picture. Then trace the word and colour the picture.

fairy



Connect the dots to complete the picture. Then trace the word and colour the picture.

shark

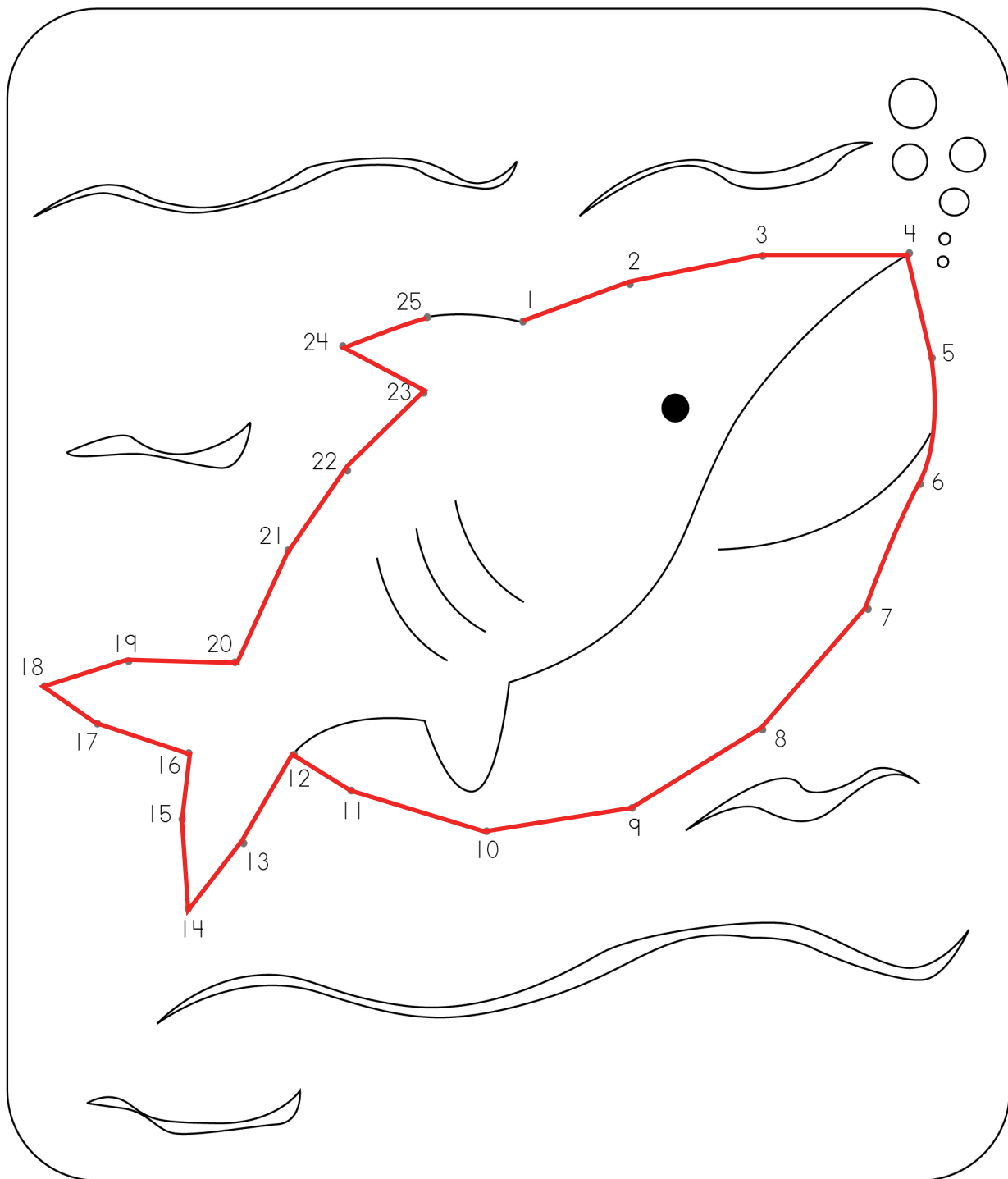

Connect the dots to complete the picture. Then trace the word and colour the picture.

stingray

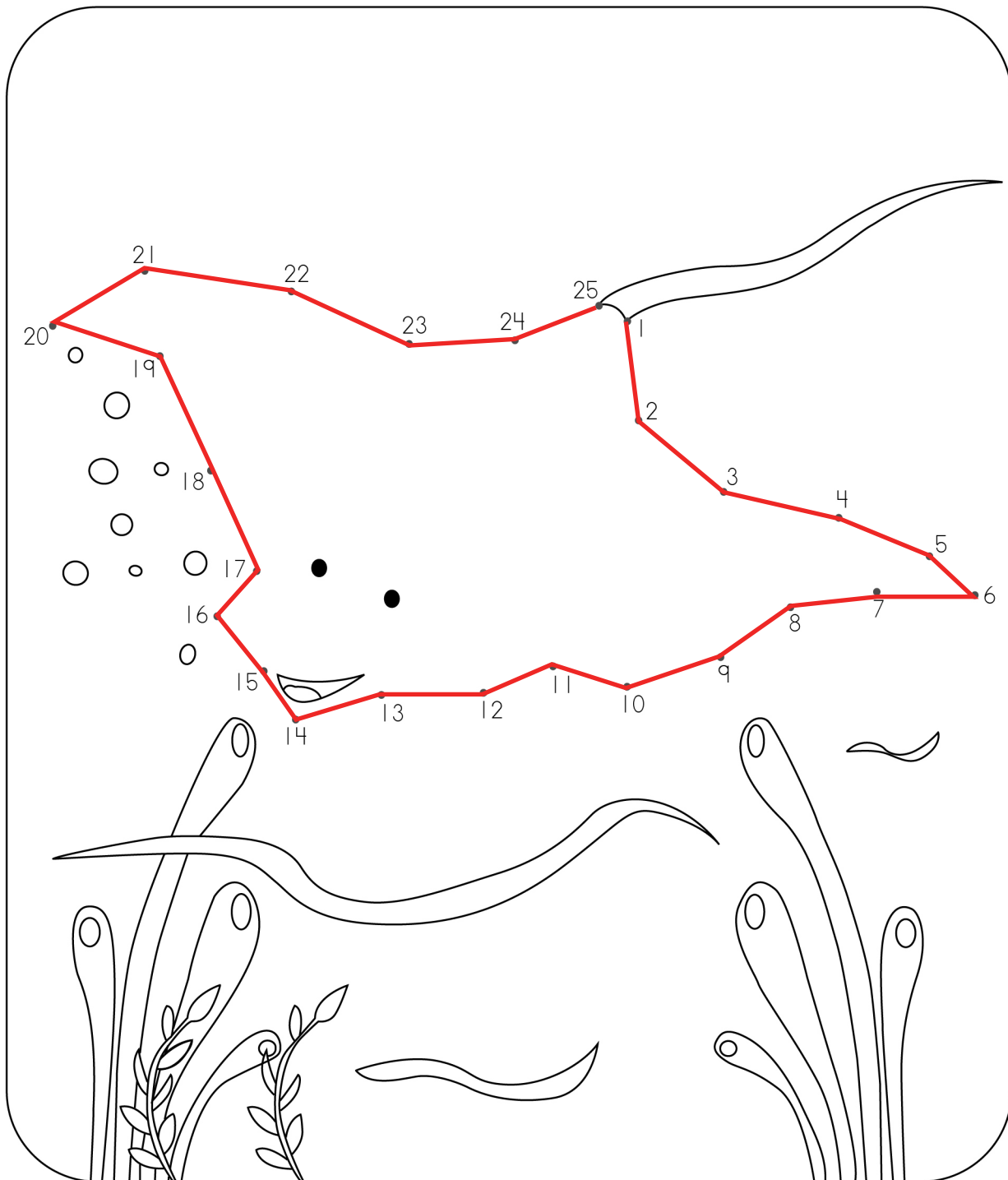

Connect the dots to complete the picture. Then trace the word and colour the picture.

teacher

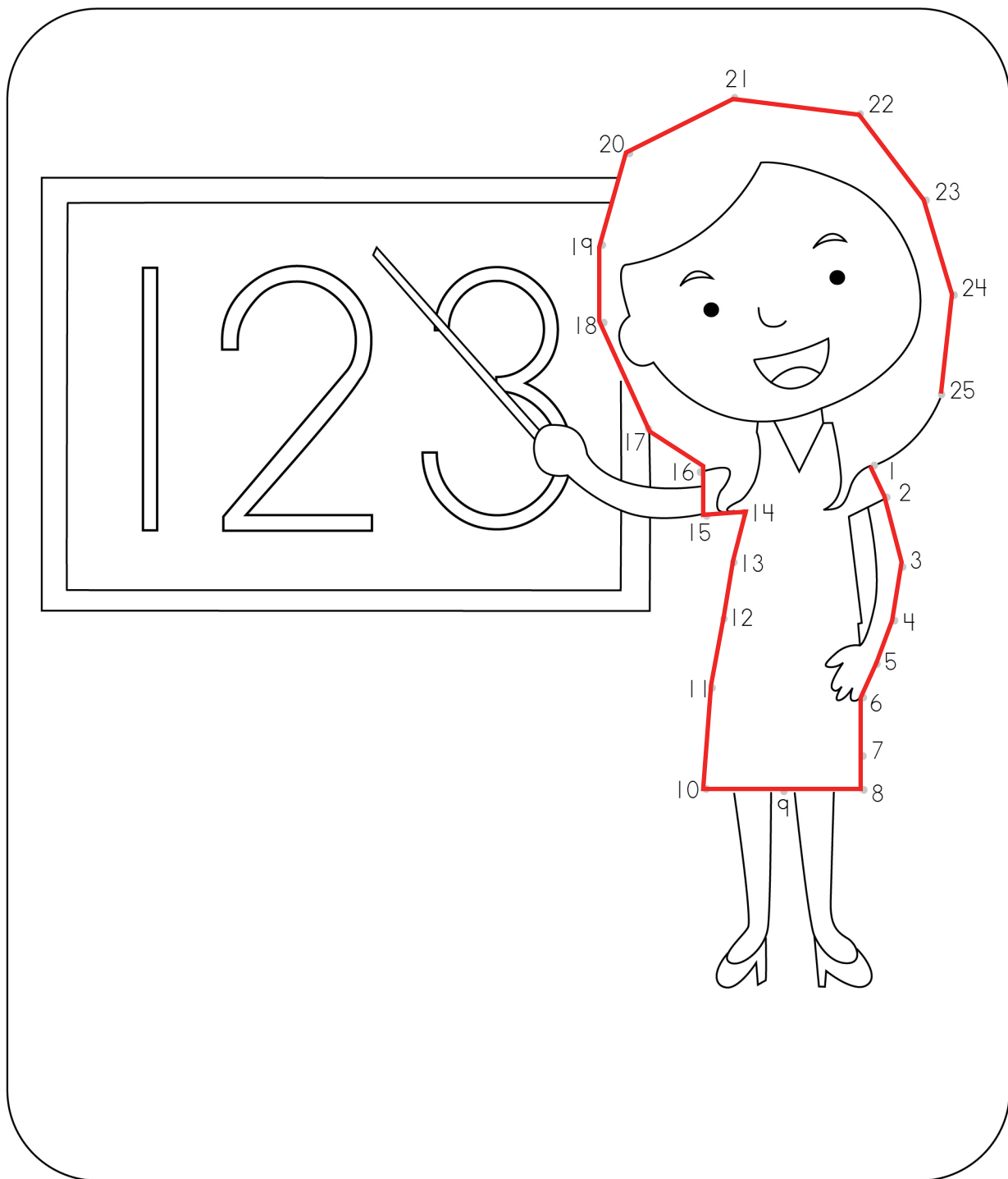

Connect the dots to complete the picture. Then trace the word and colour the picture.

grasshopper

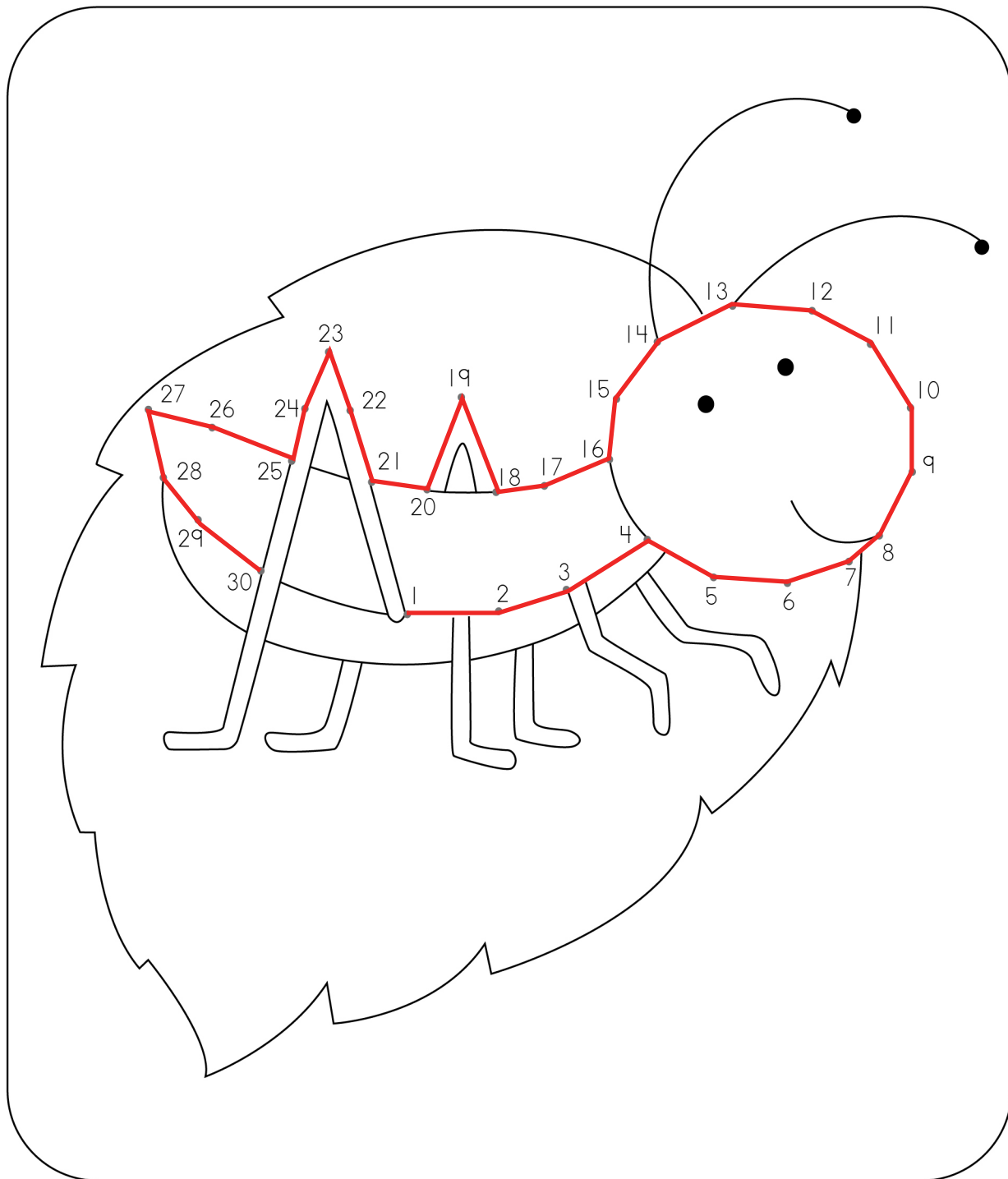

Connect the dots to complete the picture. Then trace the word and colour the picture.

hamster

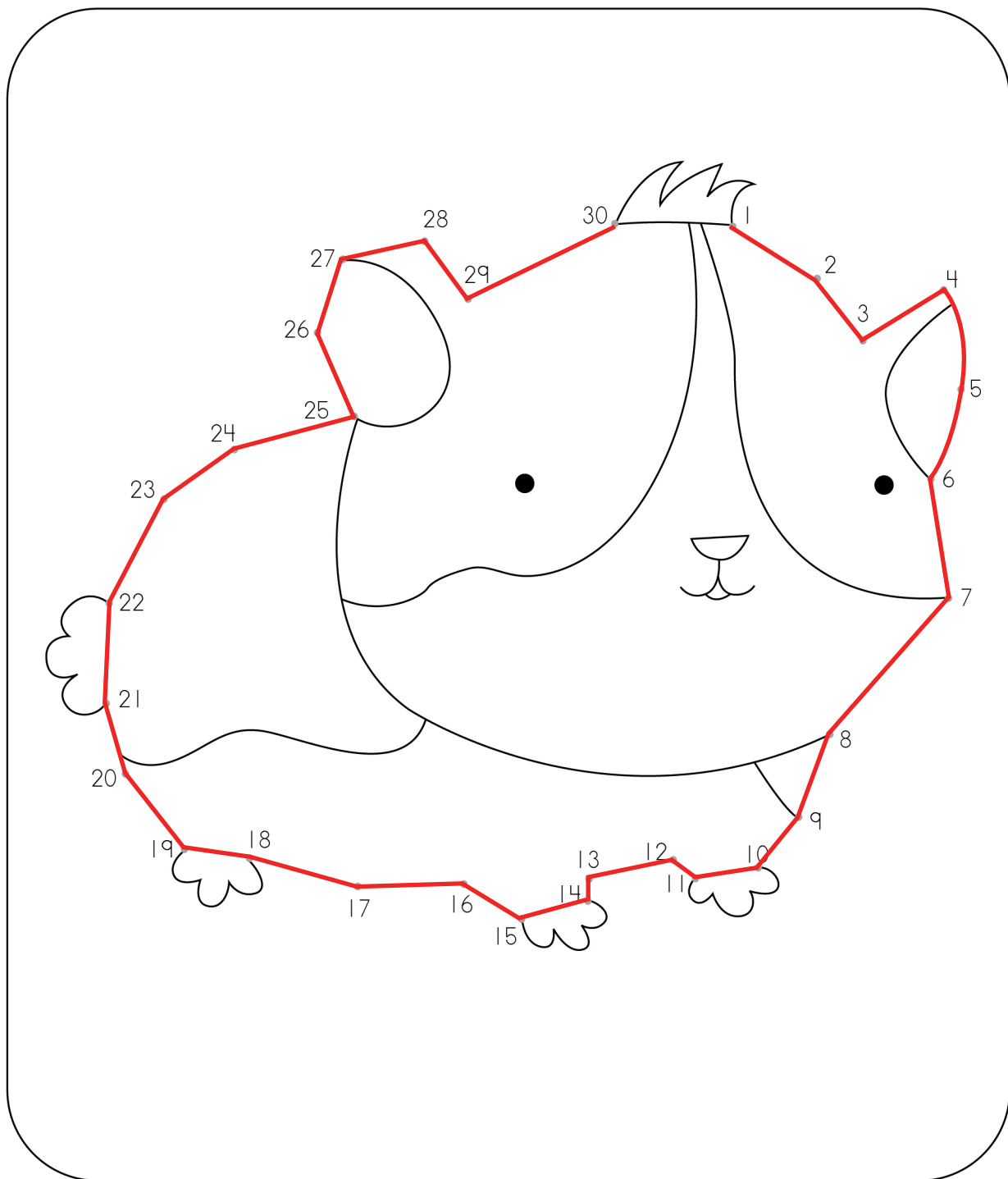

Connect the dots to complete the picture. Then trace the word and colour the picture.

train

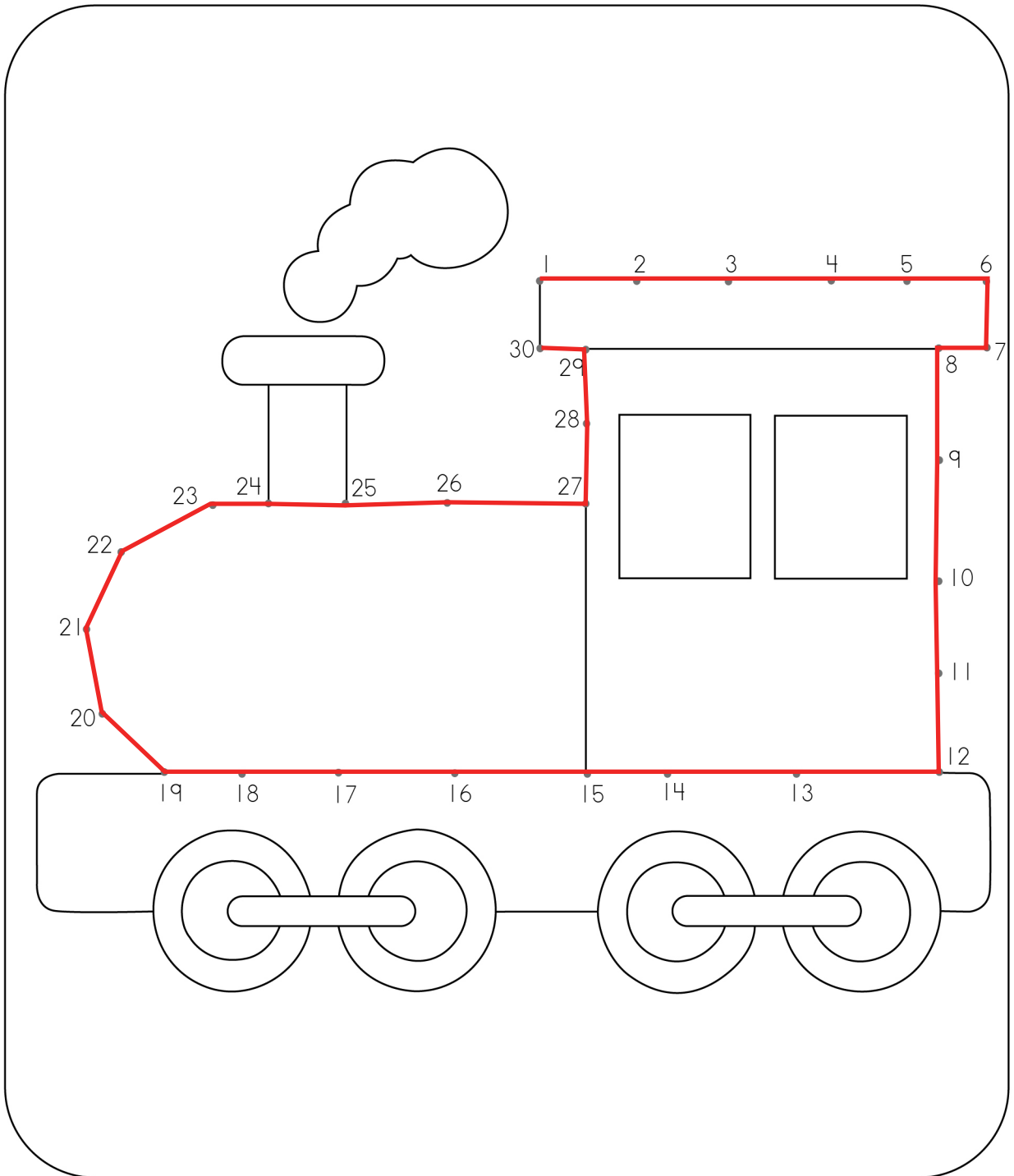

Connect the dots to complete the picture. Then trace the word and colour the picture.

turtle

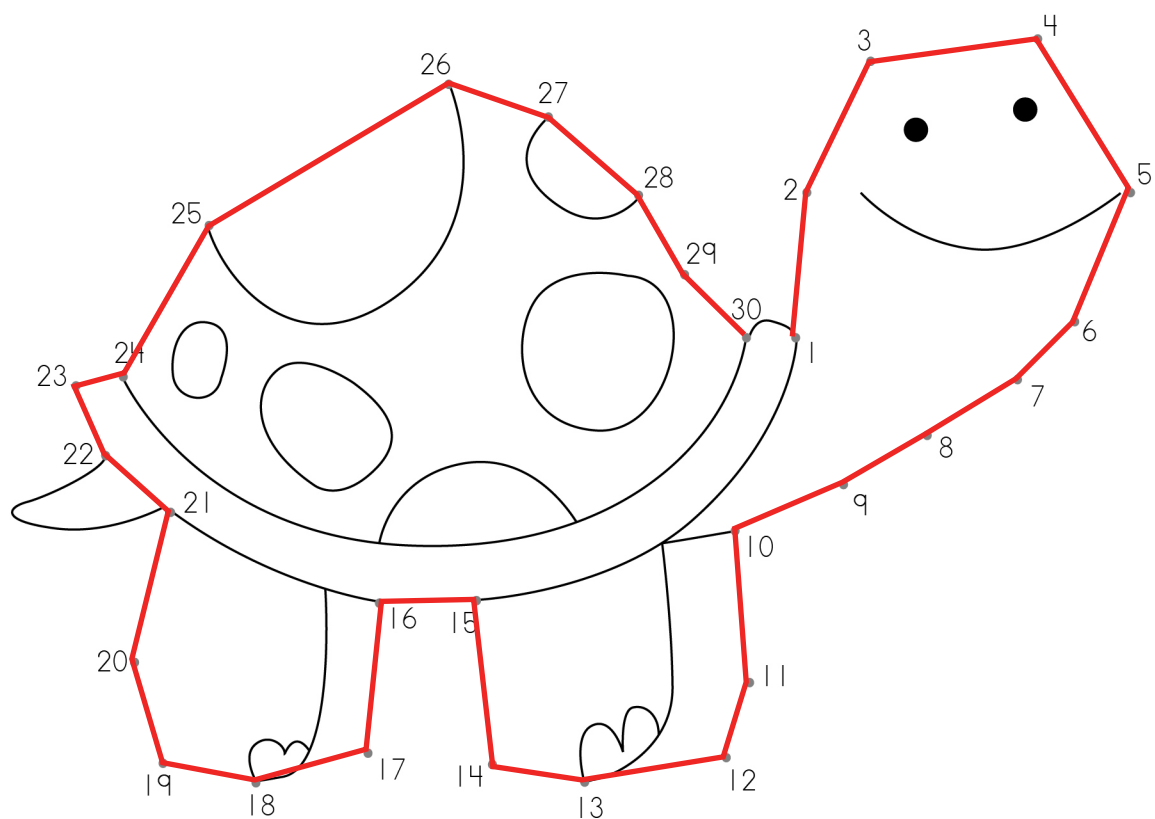

Connect the dots to complete the picture. Then trace the word and colour the picture.

whale

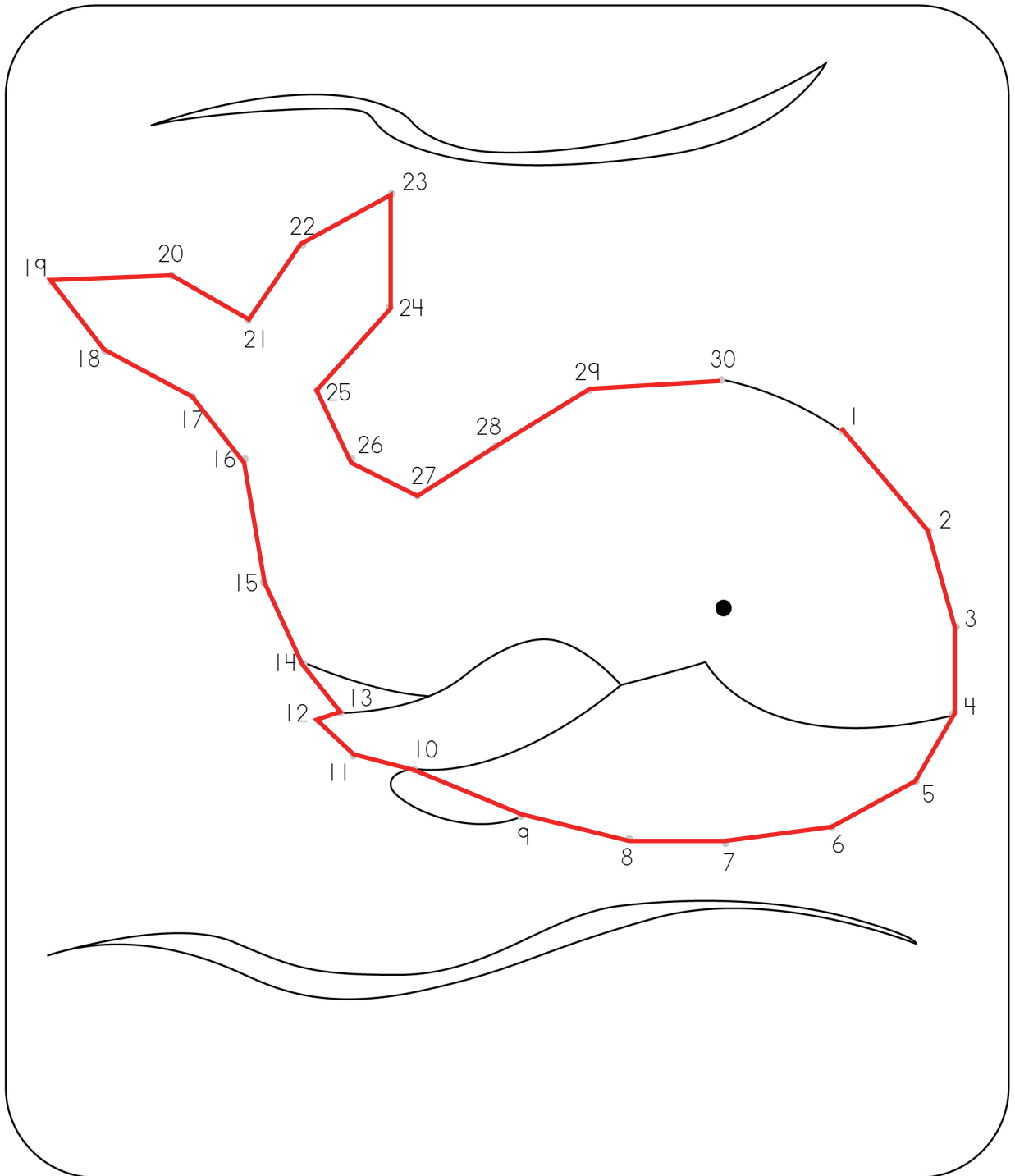

Connect the dots to complete the picture. Then trace the word and colour the picture.

butterfly

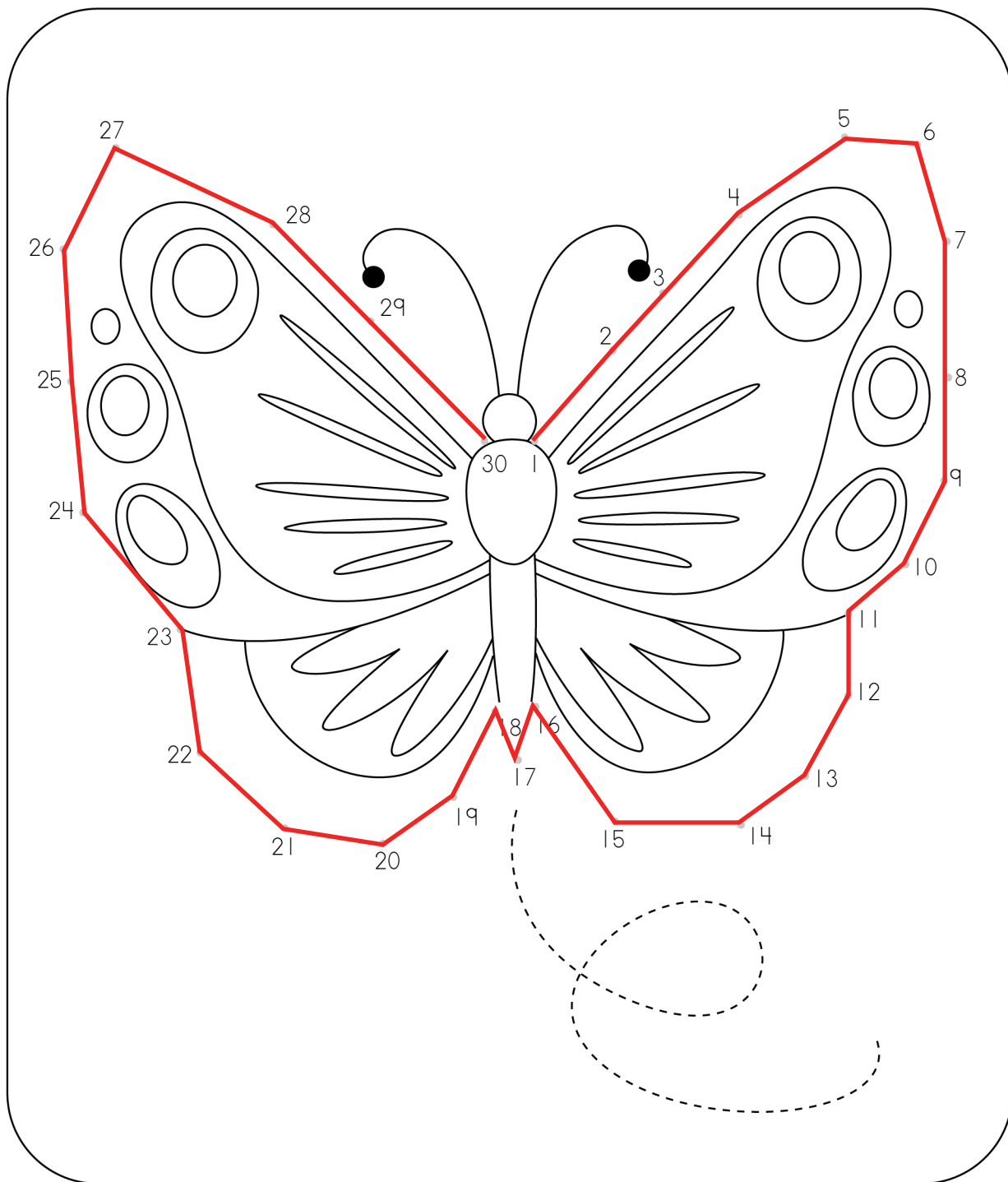

Connect the dots to complete the picture. Then trace the word and colour the picture.

nurse

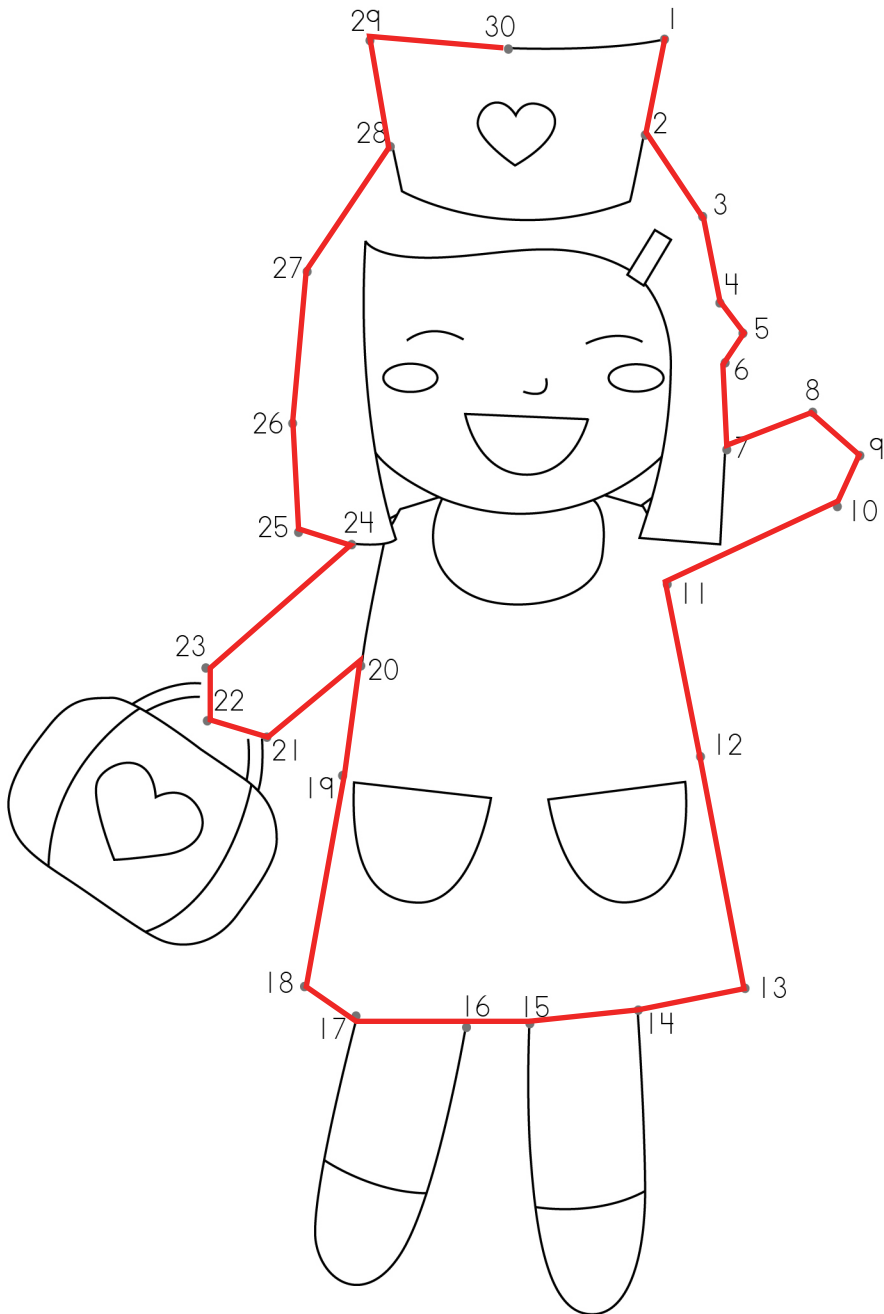

Connect the dots to complete the picture. Then trace the word and colour the picture.

pig

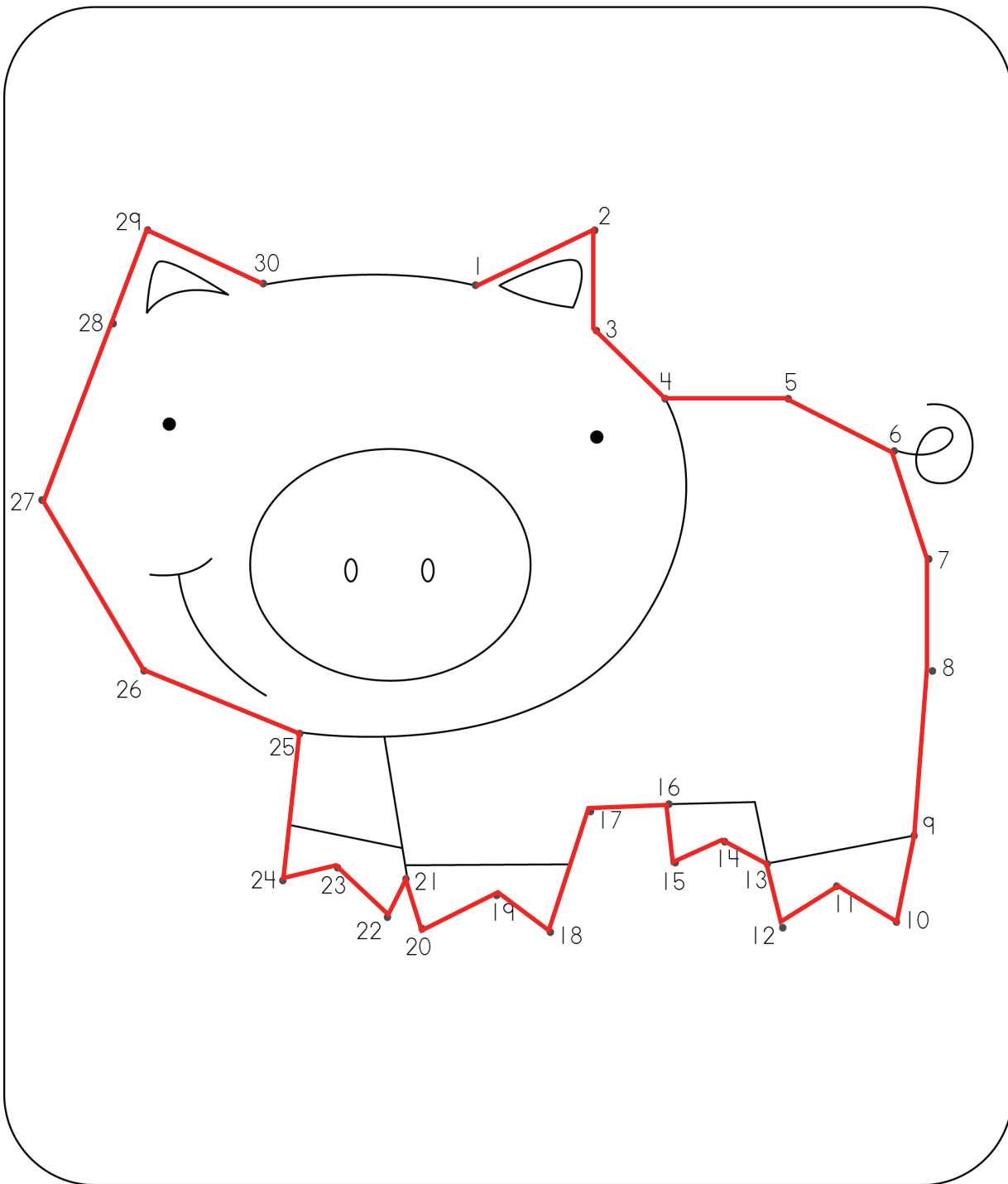

Connect the dots to complete the picture. Then trace the word and colour the picture.

horse

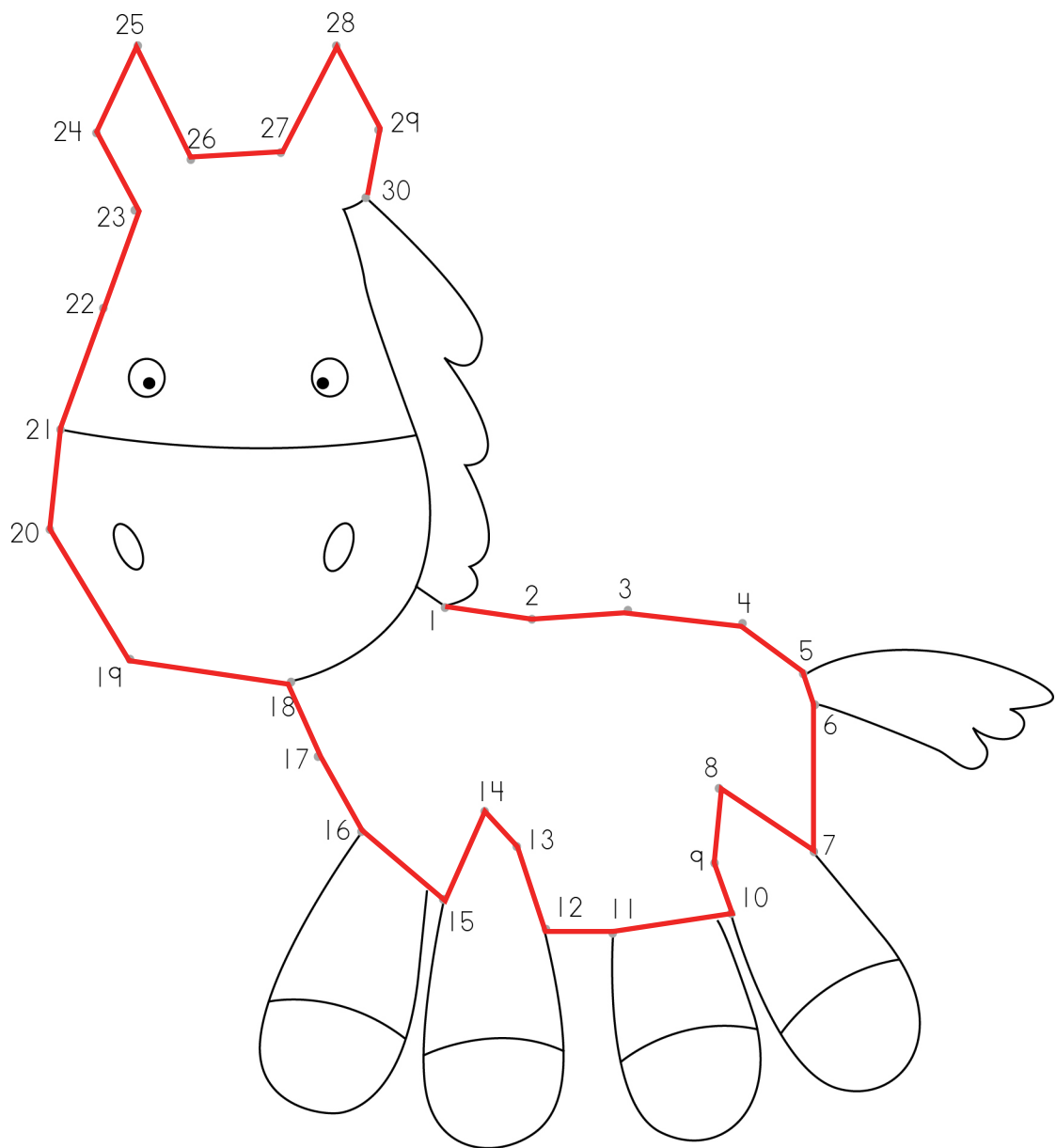

Connect the dots to complete the picture. Then trace the word and colour the picture.

mermaid



Connect the dots to complete the picture. Then trace the word and colour the picture.

rabbit

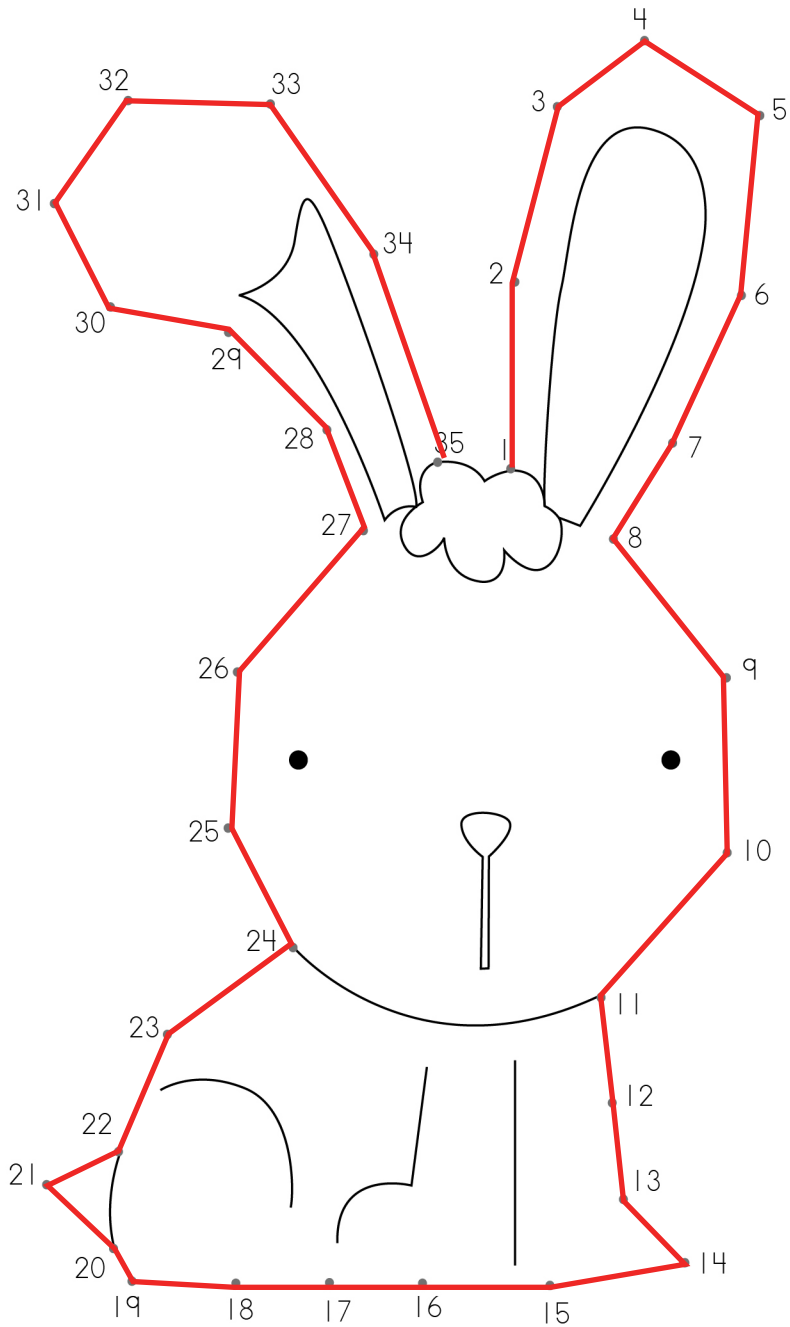

Connect the dots to complete the picture. Then trace the word and colour the picture.

elephant

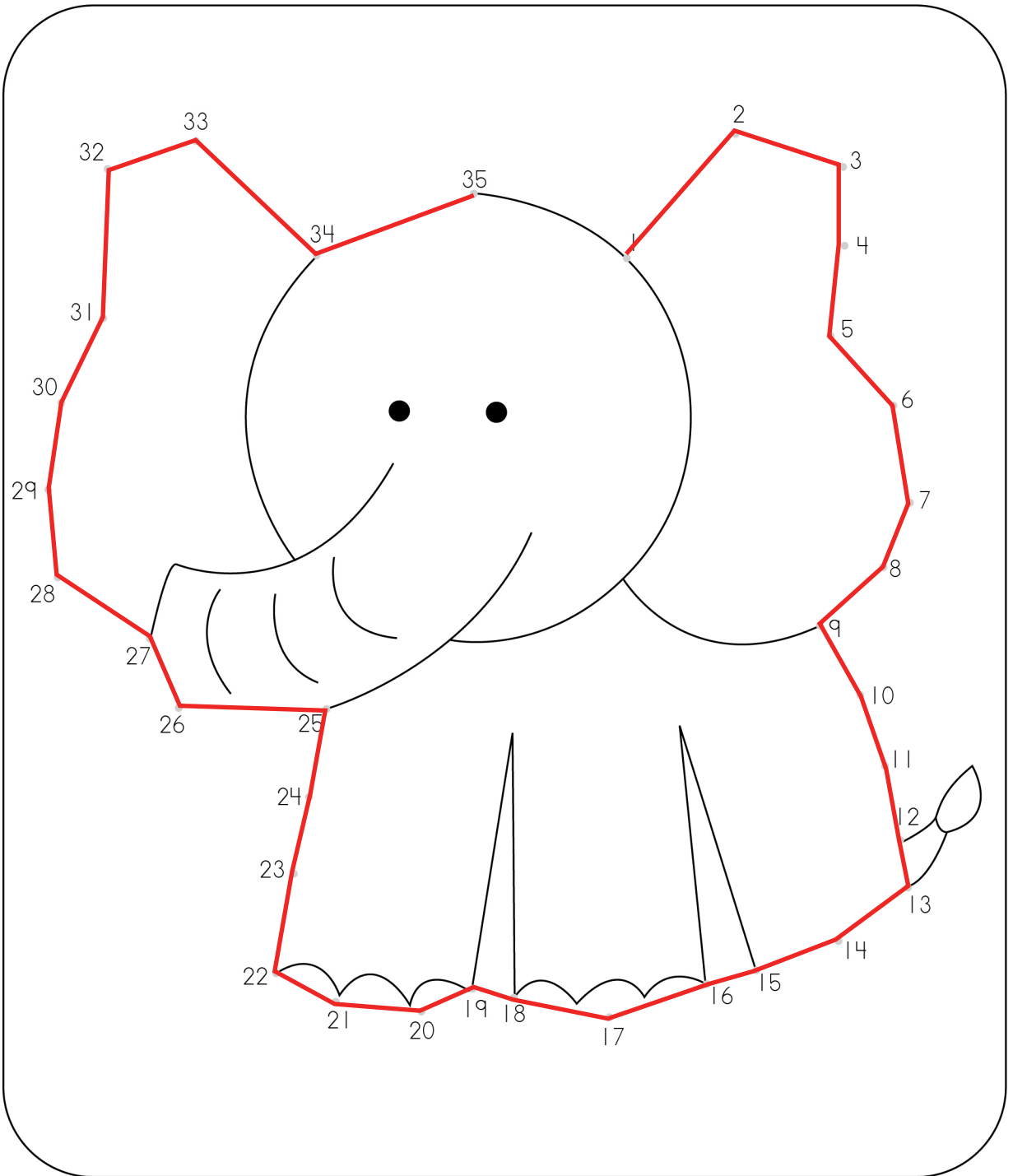

Connect the dots to complete the picture. Then trace the word and colour the picture.

goat

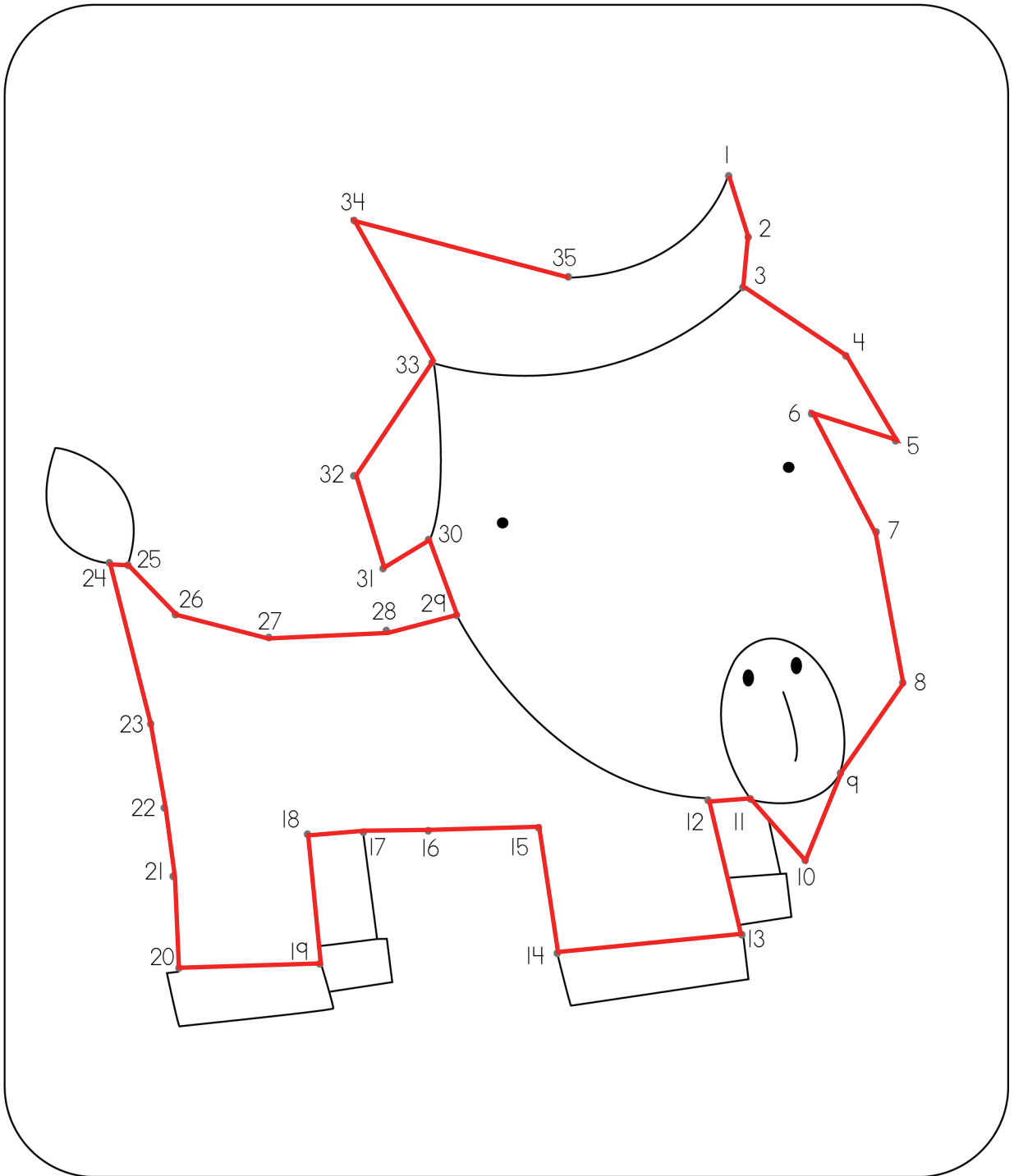

Connect the dots to complete the picture. Then trace the word and colour the picture.

lion

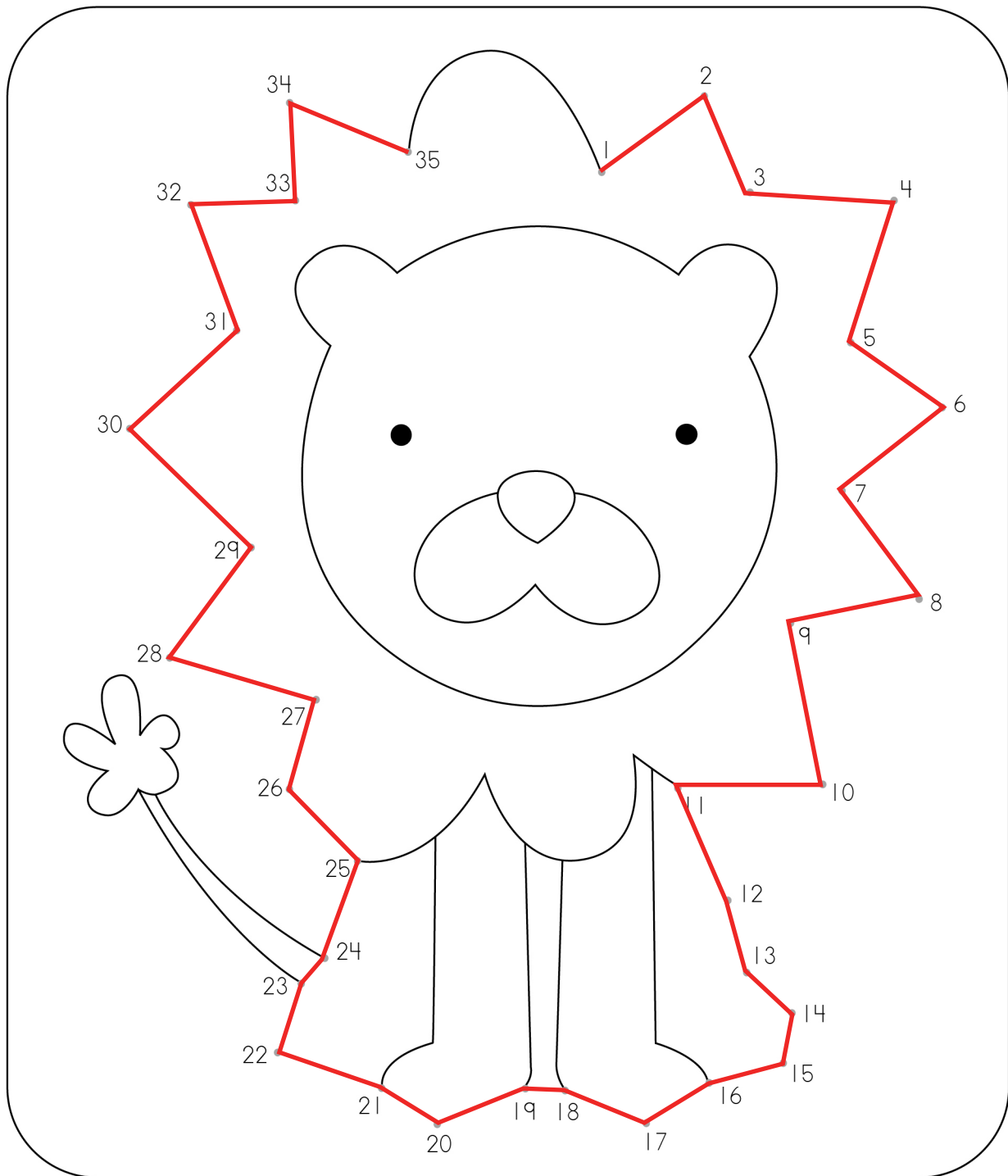

Connect the dots to complete the picture. Then trace the word and colour the picture.

gorilla

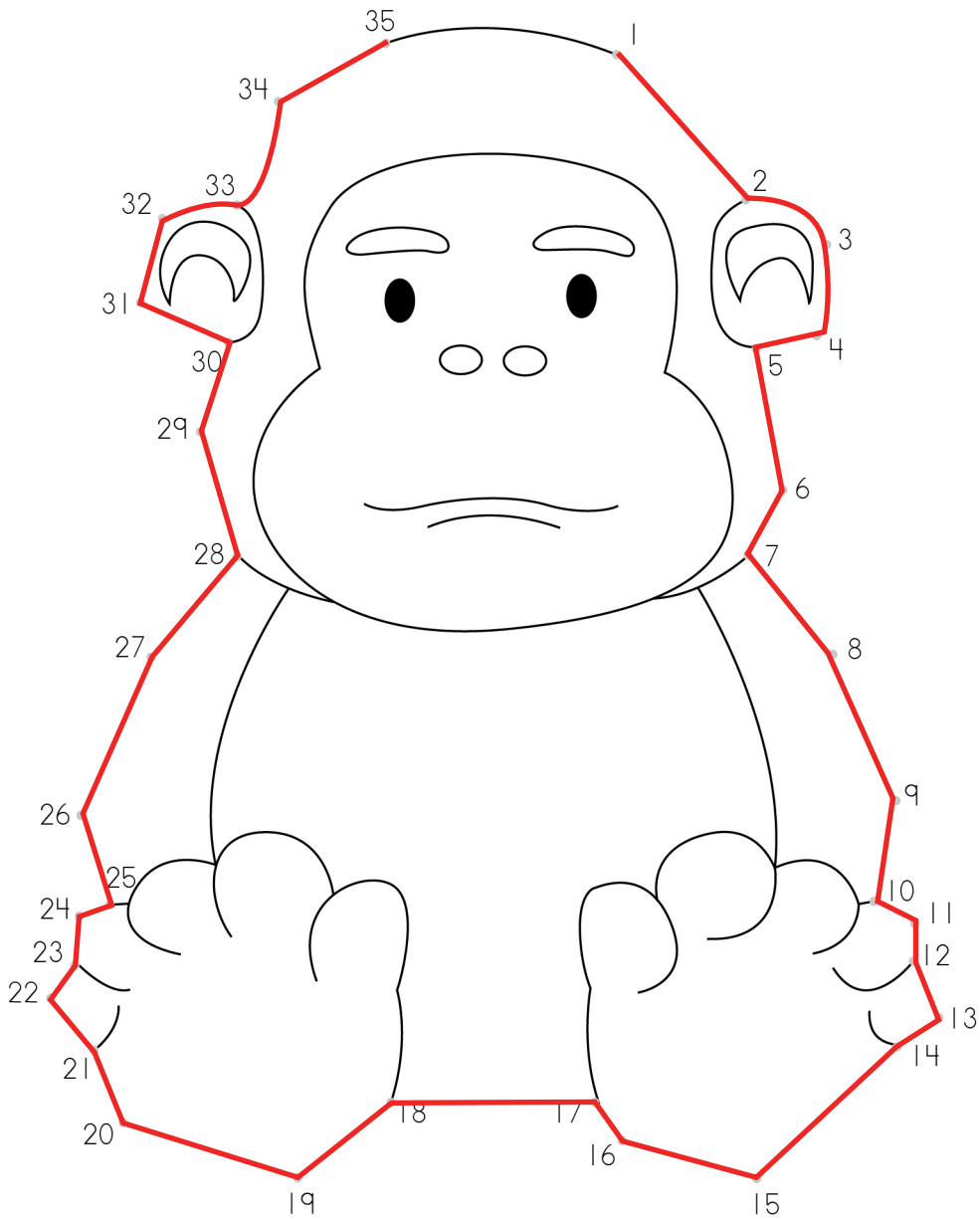

Connect the dots to complete the picture. Then trace the word and colour the picture.

mail carrier

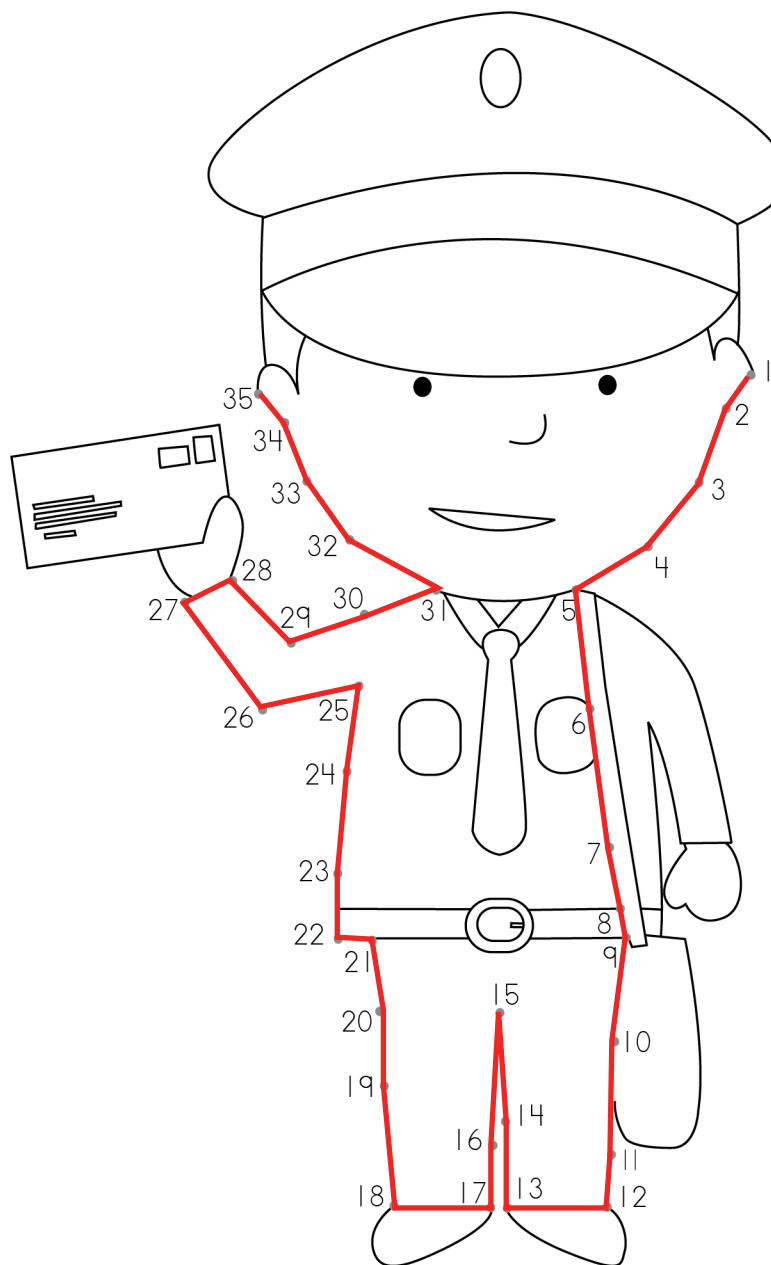

Connect the dots to complete the picture. Then trace the word and colour the picture.

prince

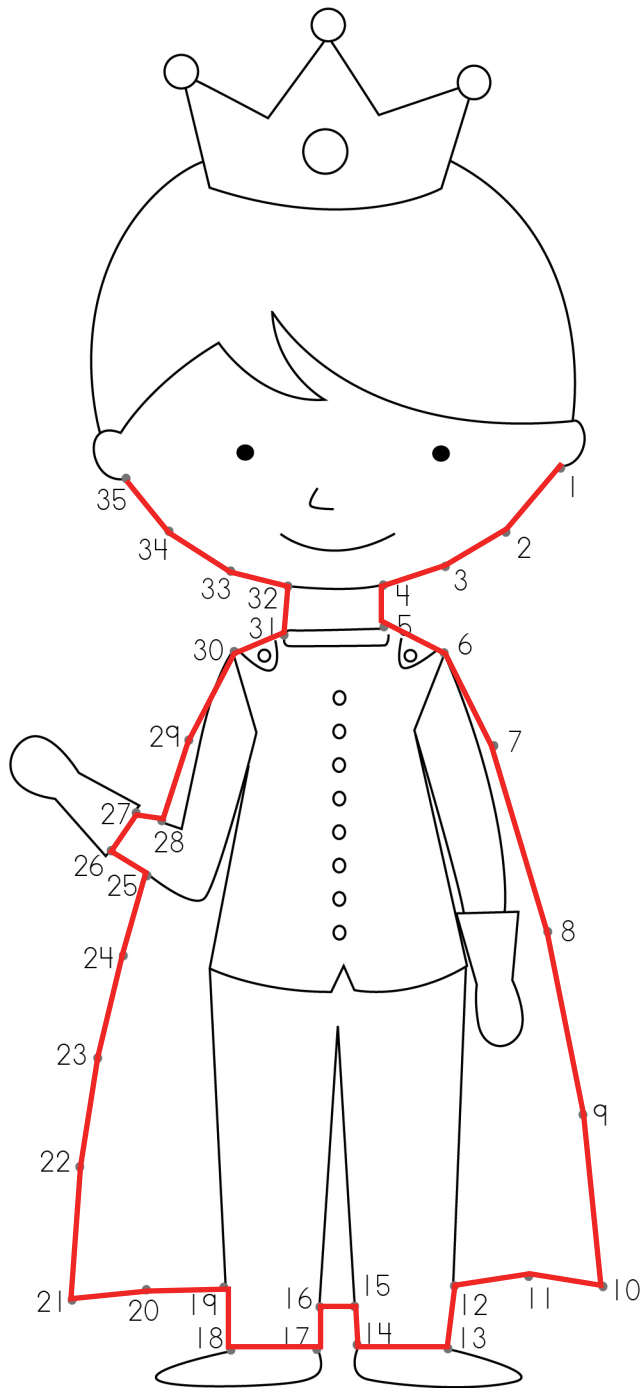

Connect the dots to complete the picture. Then trace the word and colour the picture.

school bus

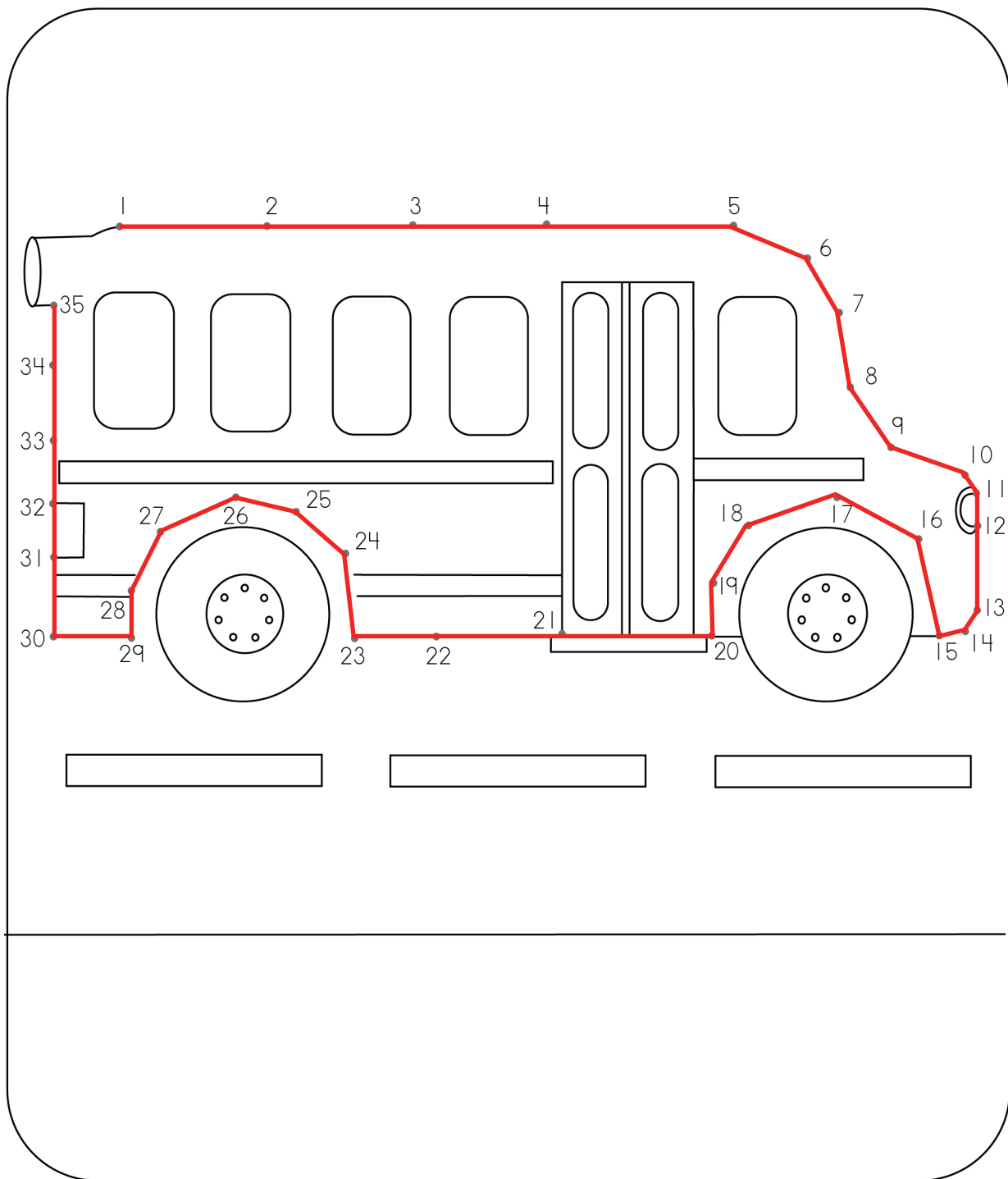

Connect the dots to complete the picture. Then trace the word and colour the picture.

seahorse

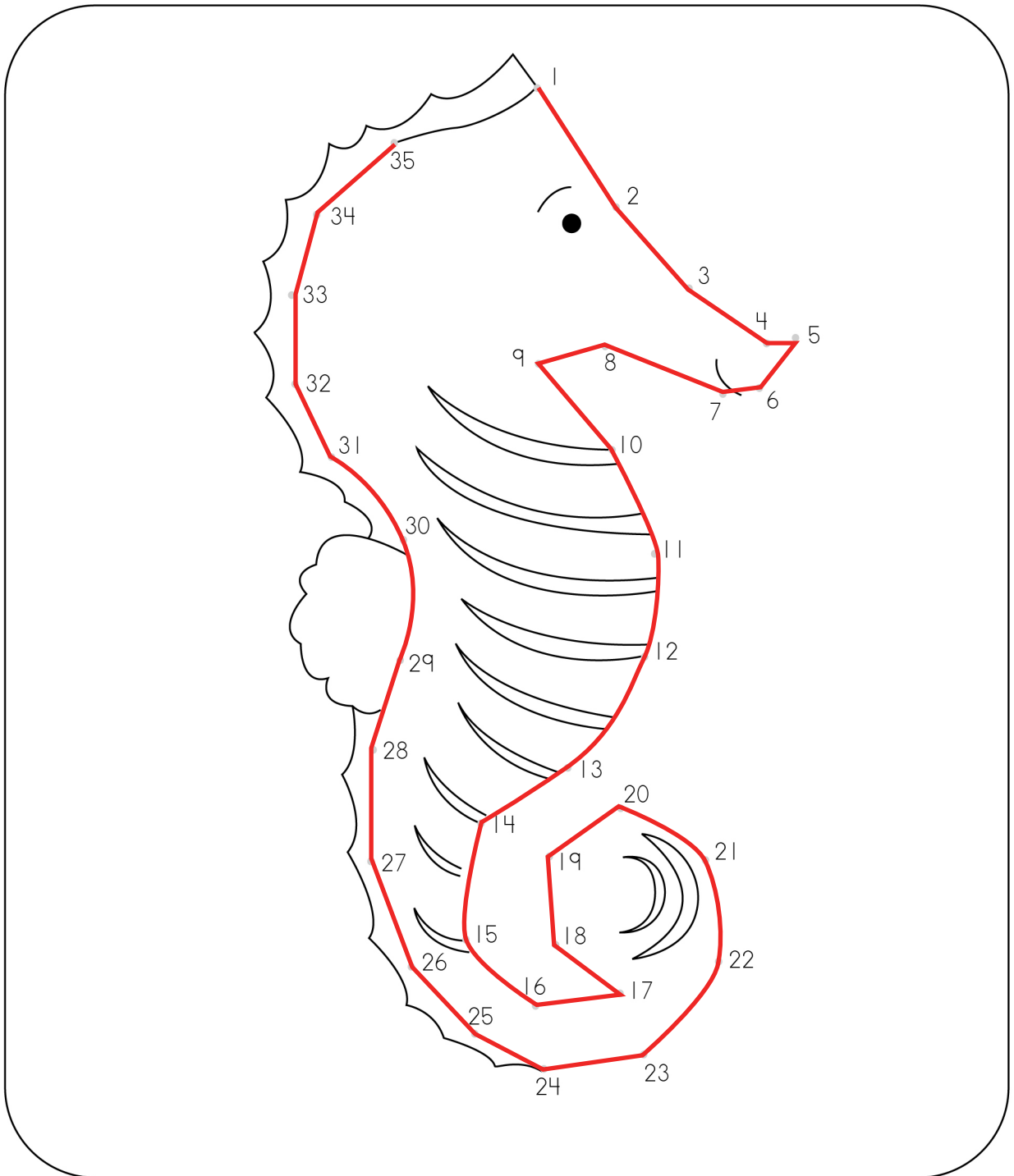

Connect the dots to complete the picture. Then trace the word and colour the picture.

beekeeper

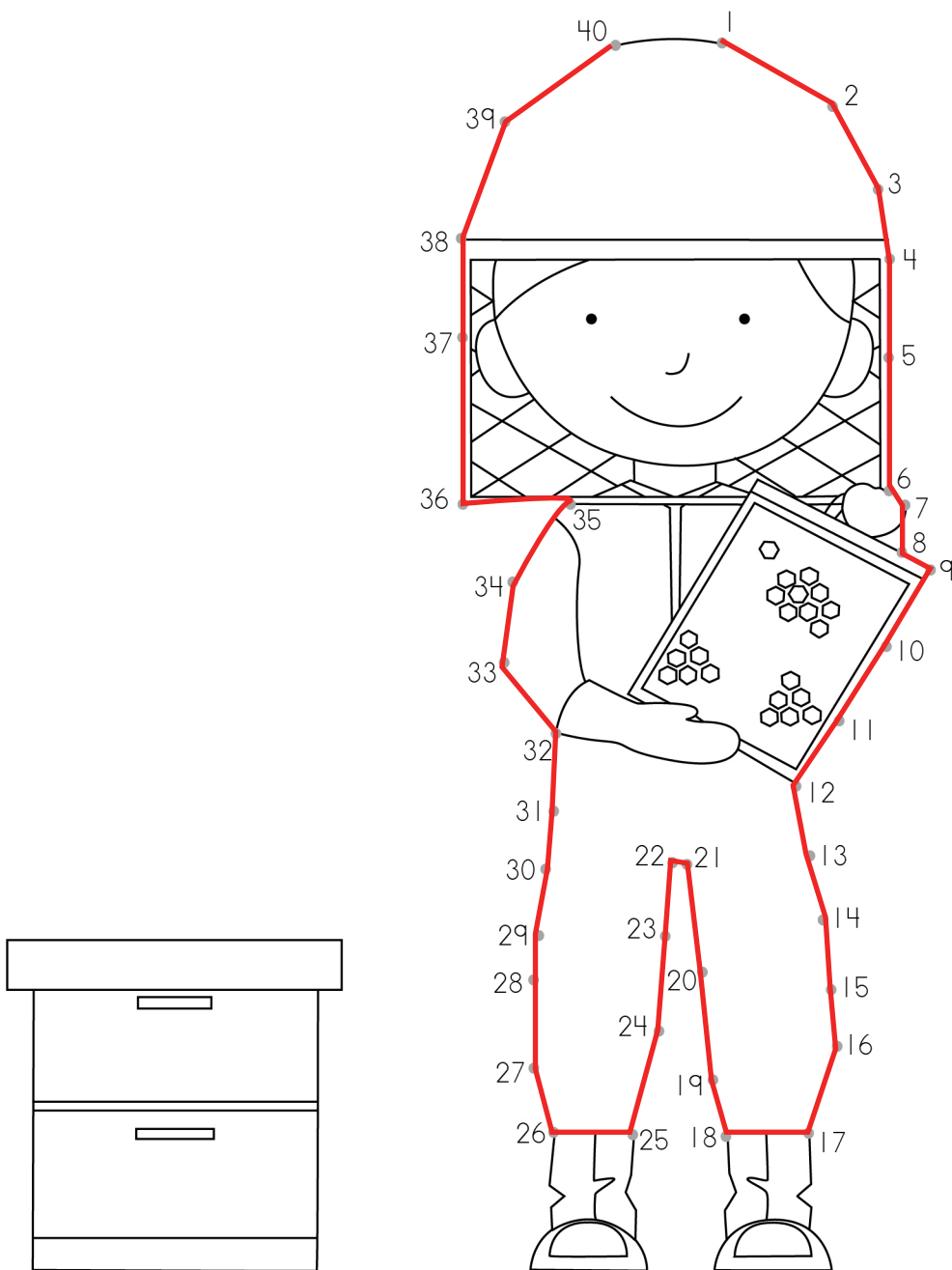

Connect the dots to complete the picture. Then trace the word and colour the picture.

tractor

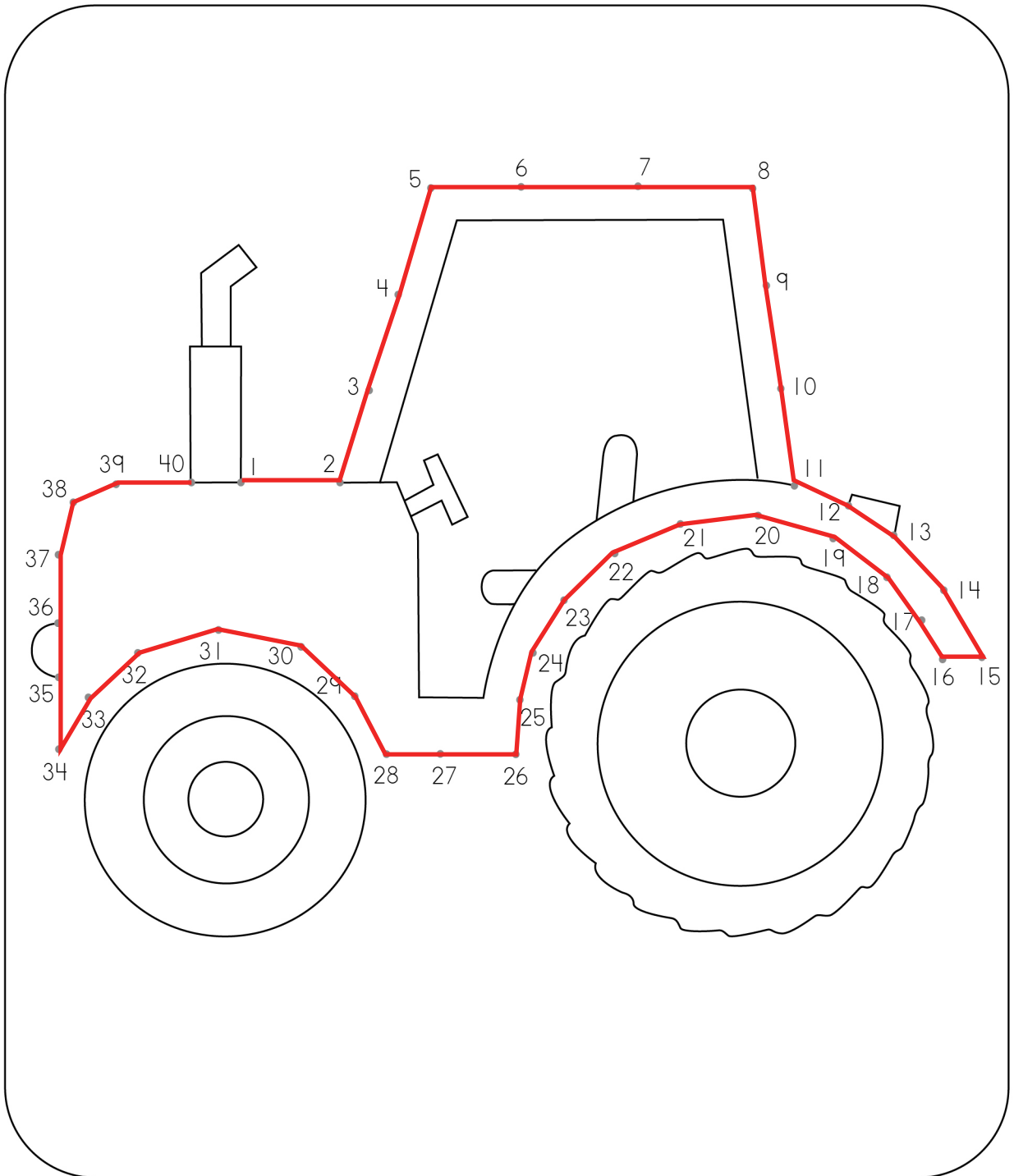

Connect the dots to complete the picture. Then trace the word and colour the picture.

sailboat

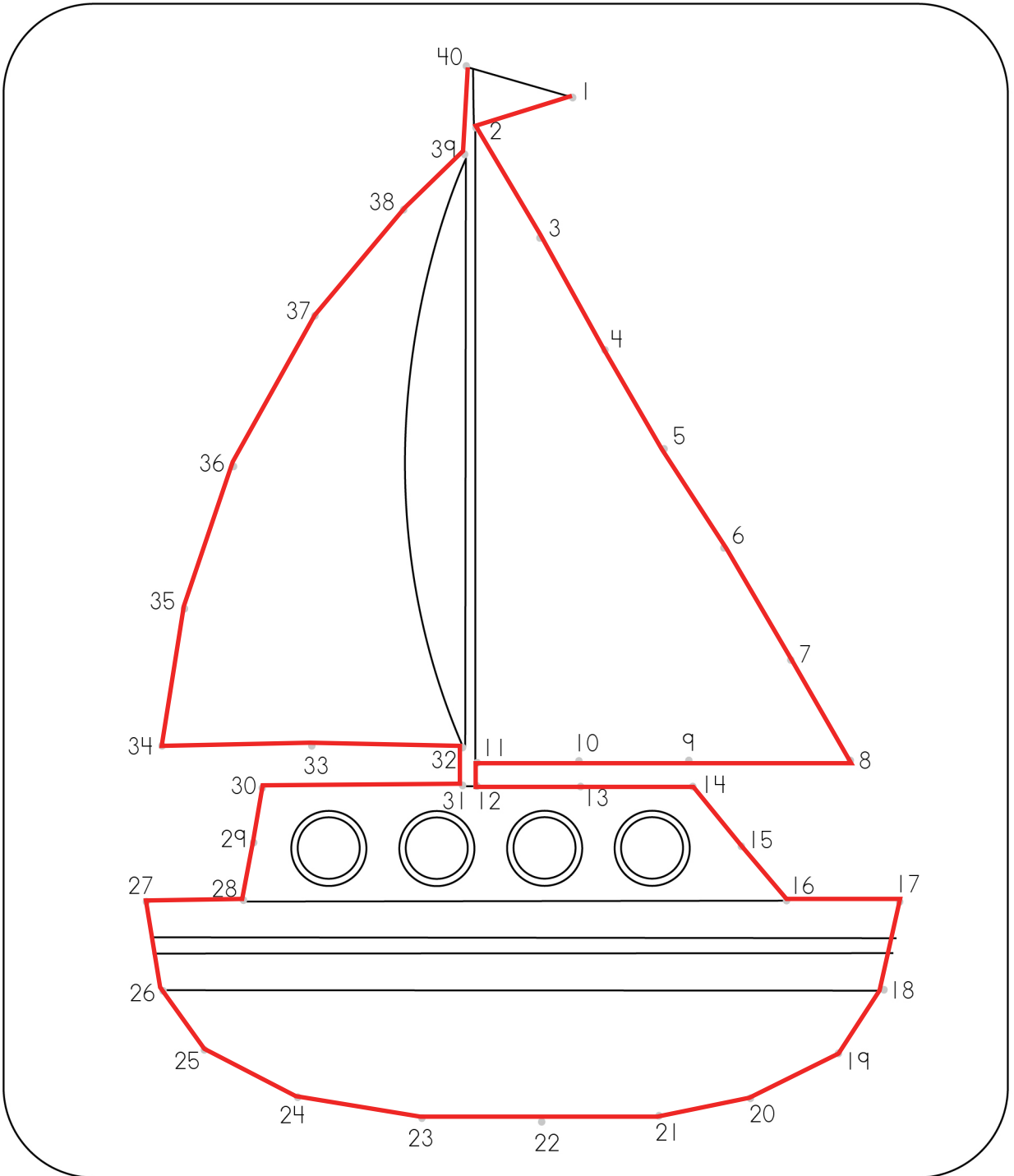

Connect the dots to complete the picture. Then trace the word and colour the picture.

dragonfly

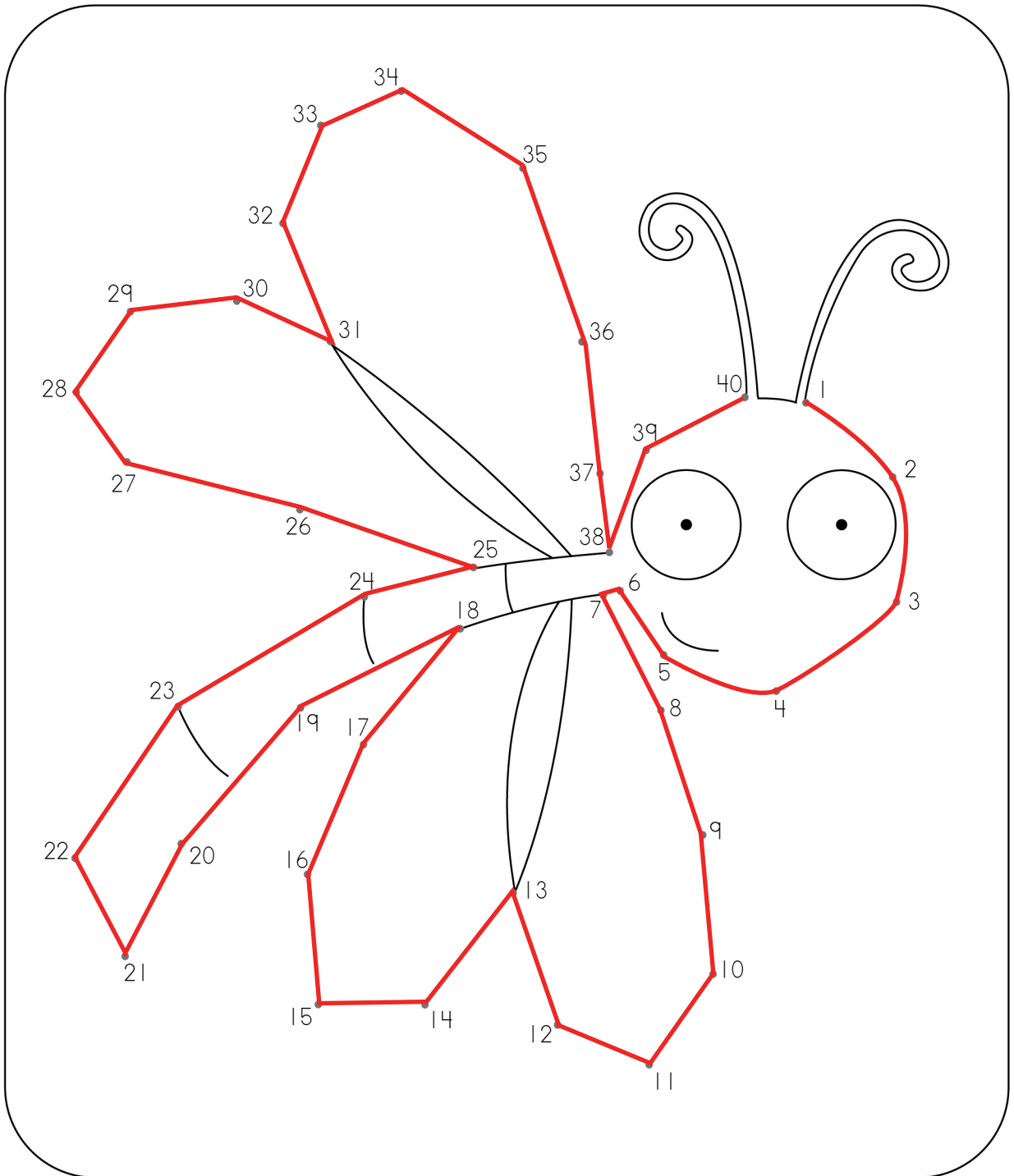

Connect the dots to complete the picture. Then trace the word and colour the picture.

queen

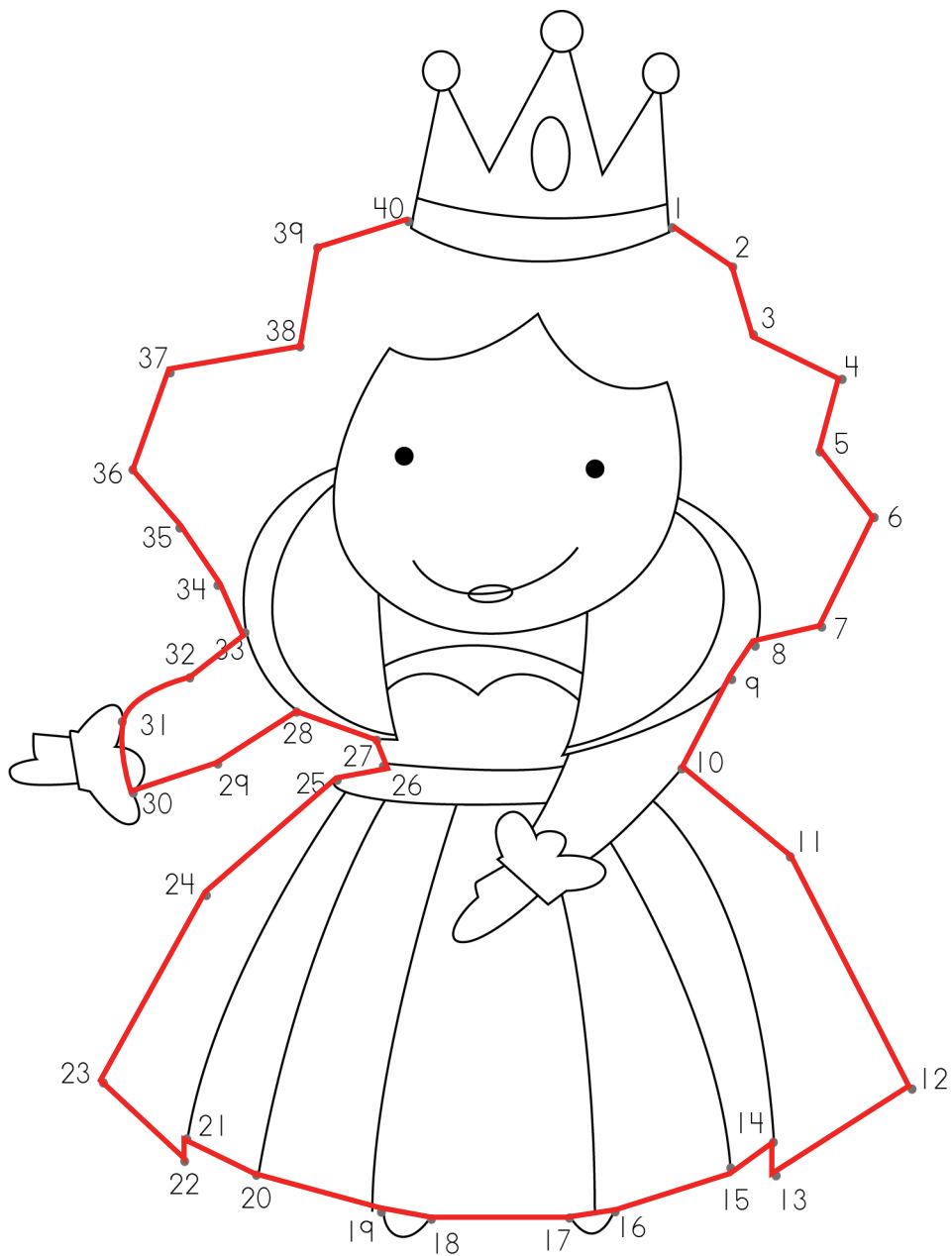

Connect the dots to complete the picture. Then trace the word and colour the picture.

hockey player

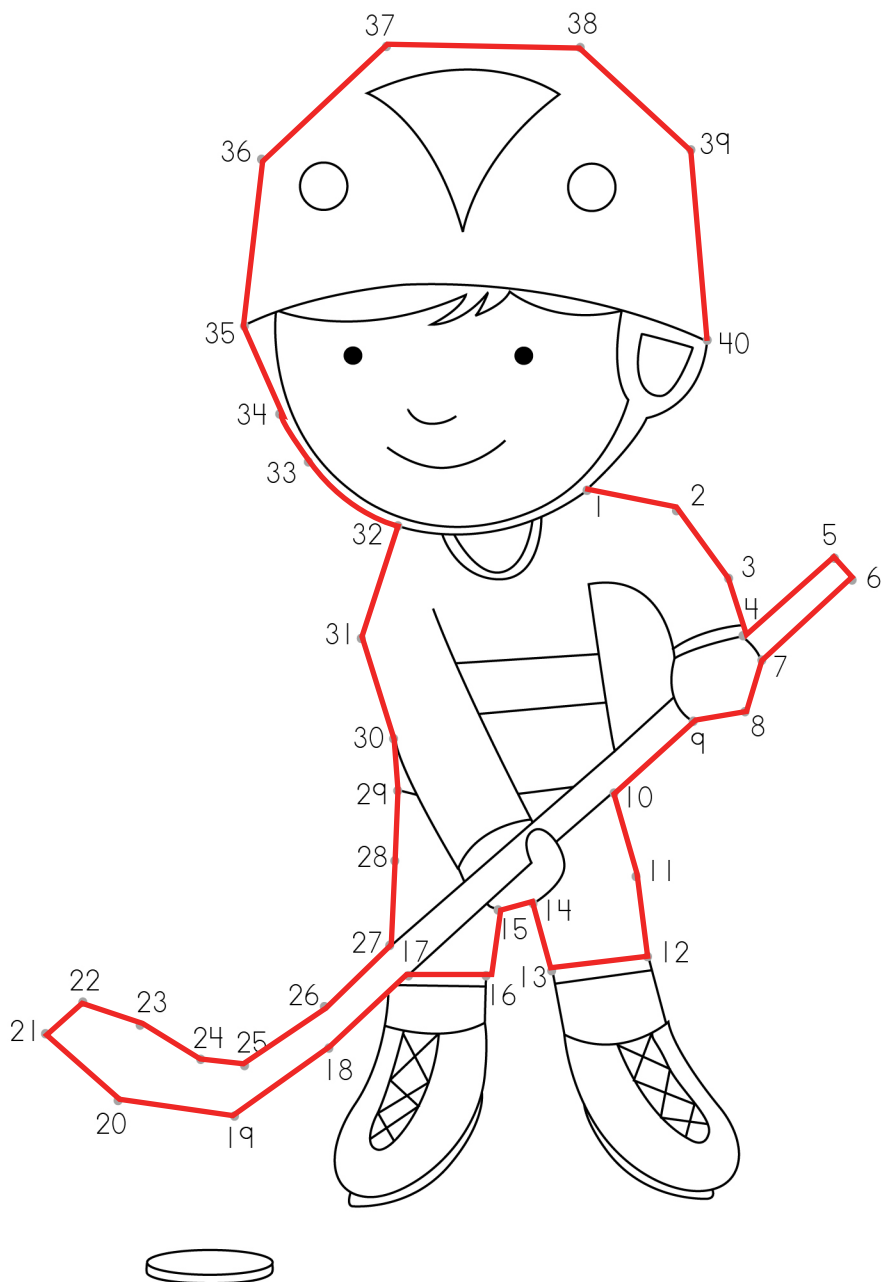

Connect the dots to complete the picture. Then trace the word and colour the picture.

tiger

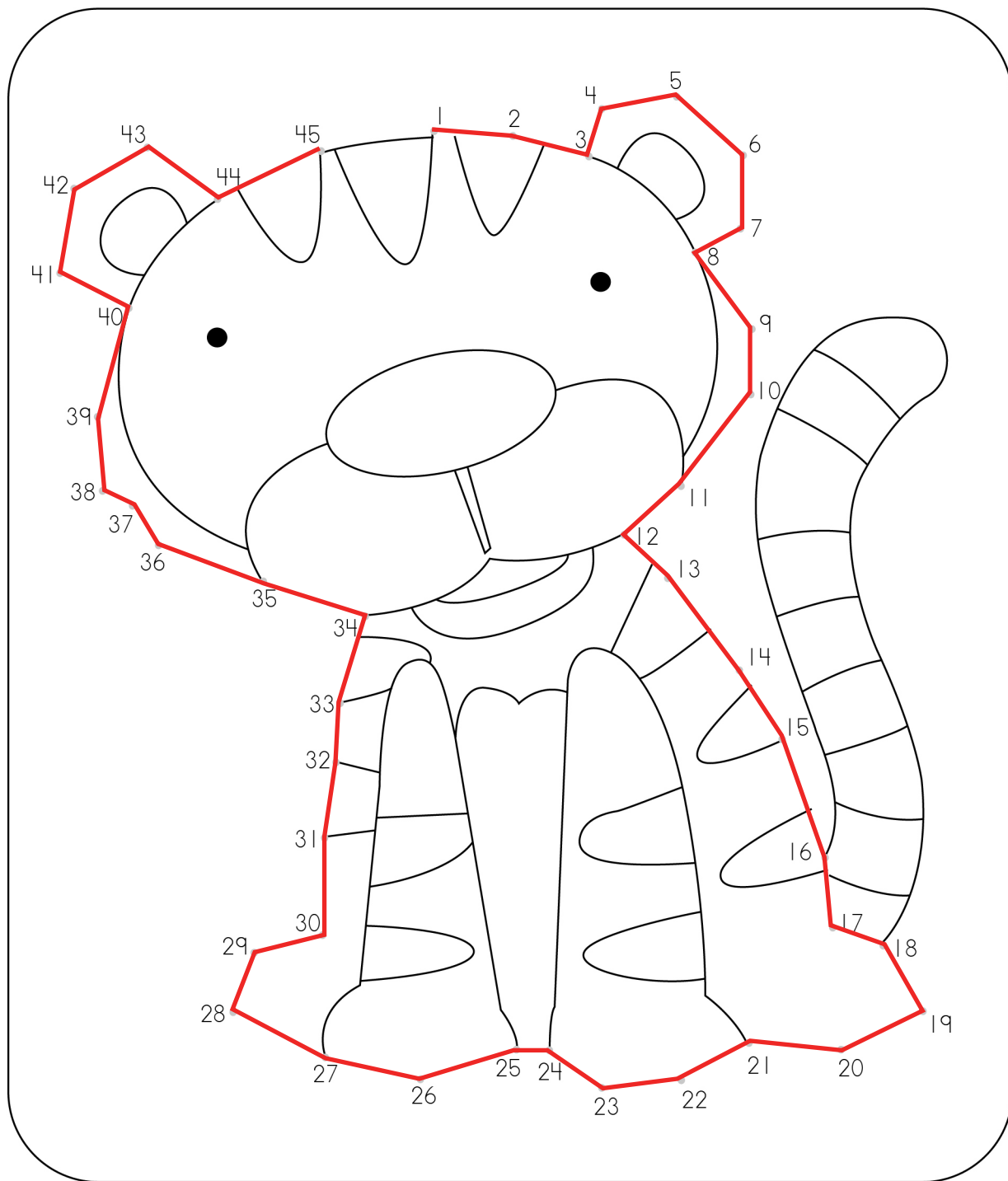

Connect the dots to complete the picture. Then trace the word and colour the picture.

artist

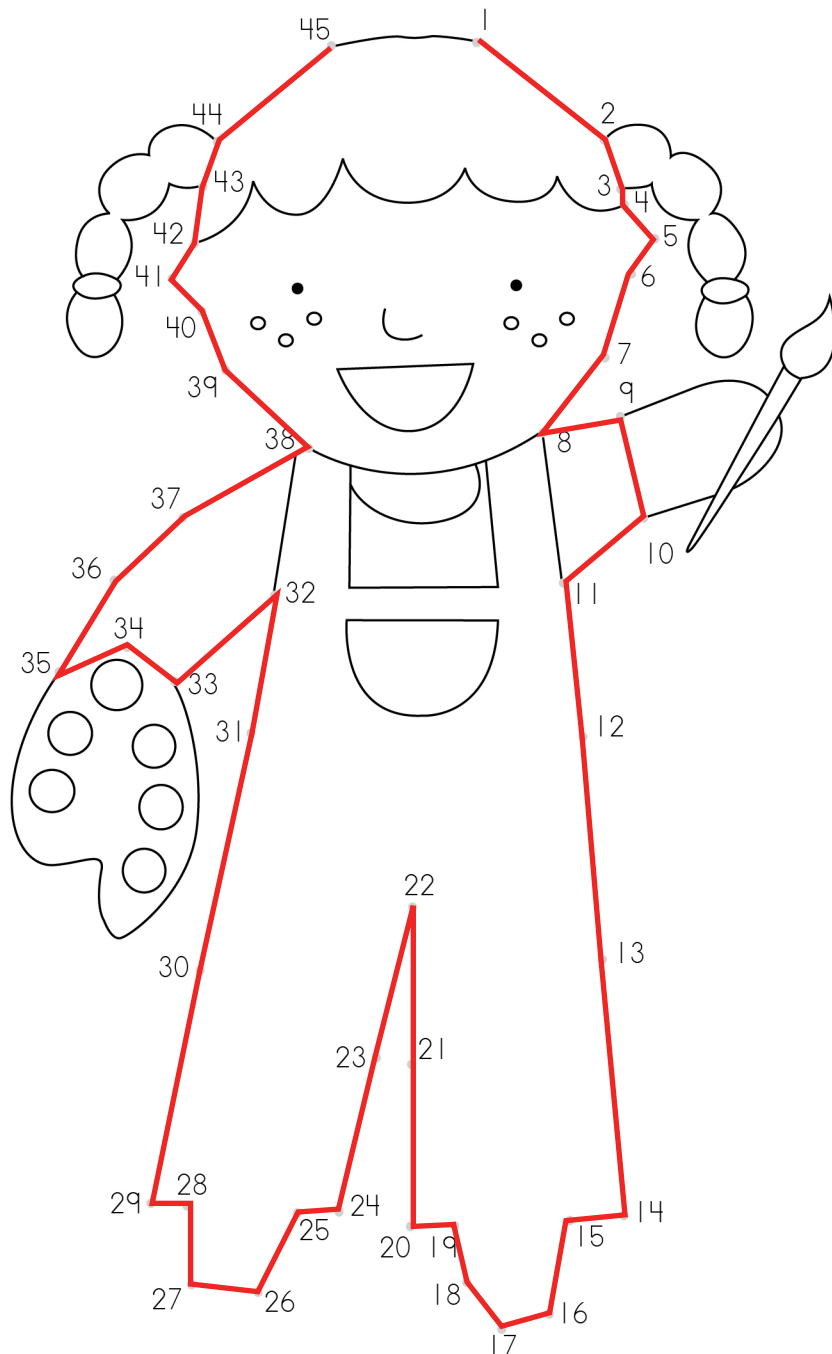

Connect the dots to complete the picture. Then trace the word and colour the picture.

unicorn

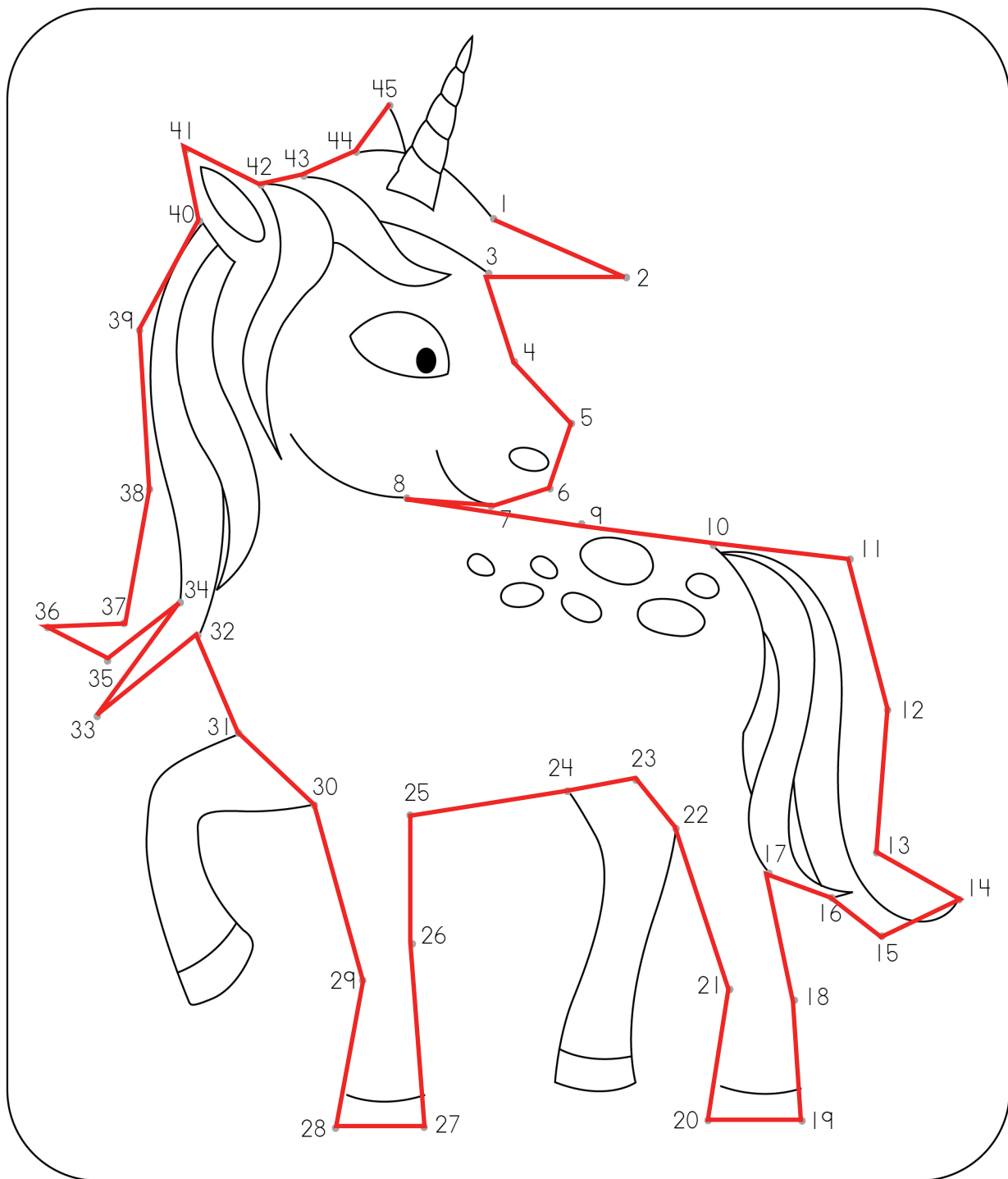

Connect the dots to complete the picture. Then trace the word and colour the picture.

wizard

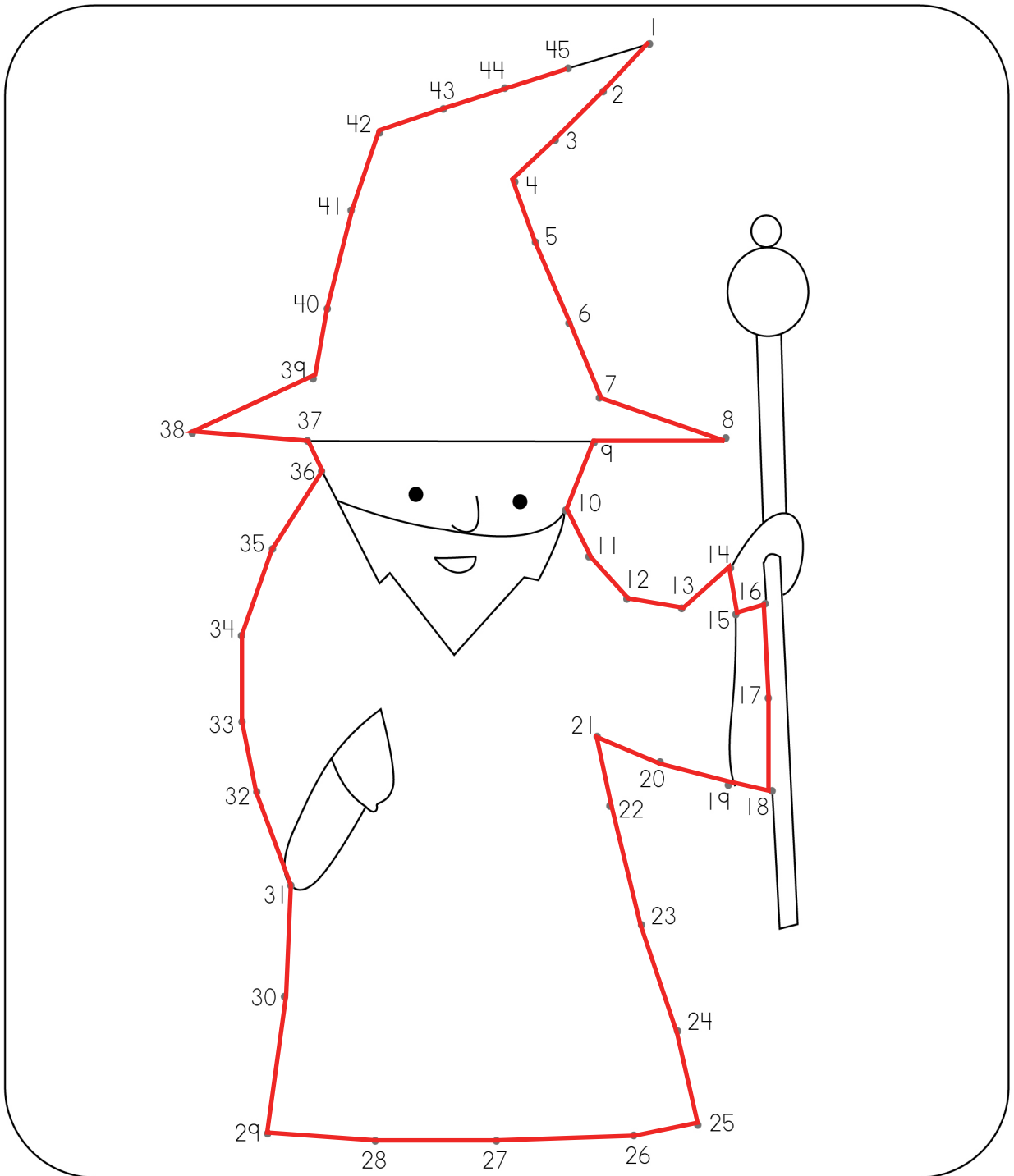

Connect the dots to complete the picture. Then trace the word and colour the picture.

dinosaur

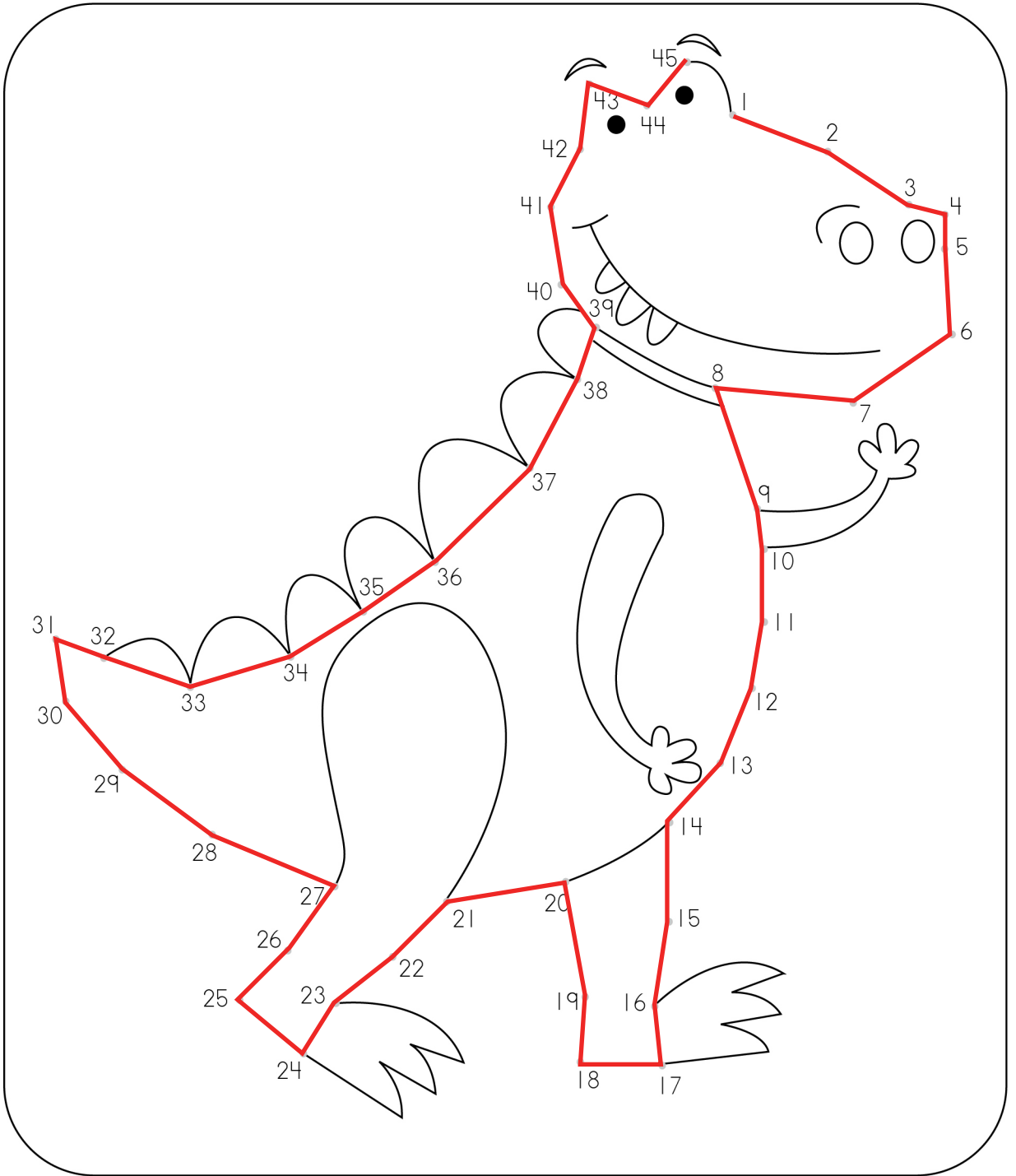

Connect the dots to complete the picture. Then trace the word and colour the picture.

dog

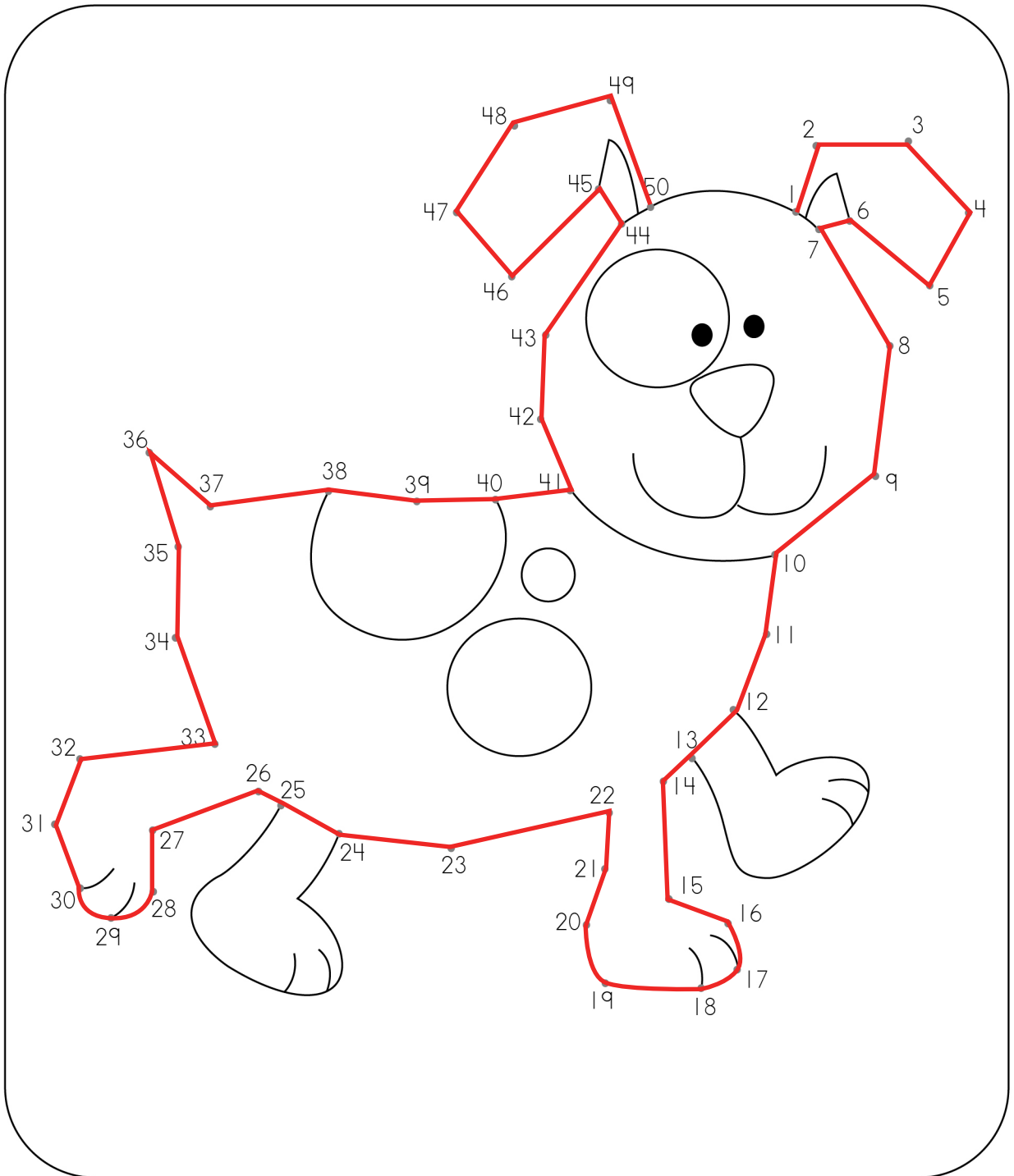

Connect the dots to complete the picture. Then trace the word and colour the picture.

firefighter



Connect the dots to complete the picture. Then trace the word and colour the picture.

zebra

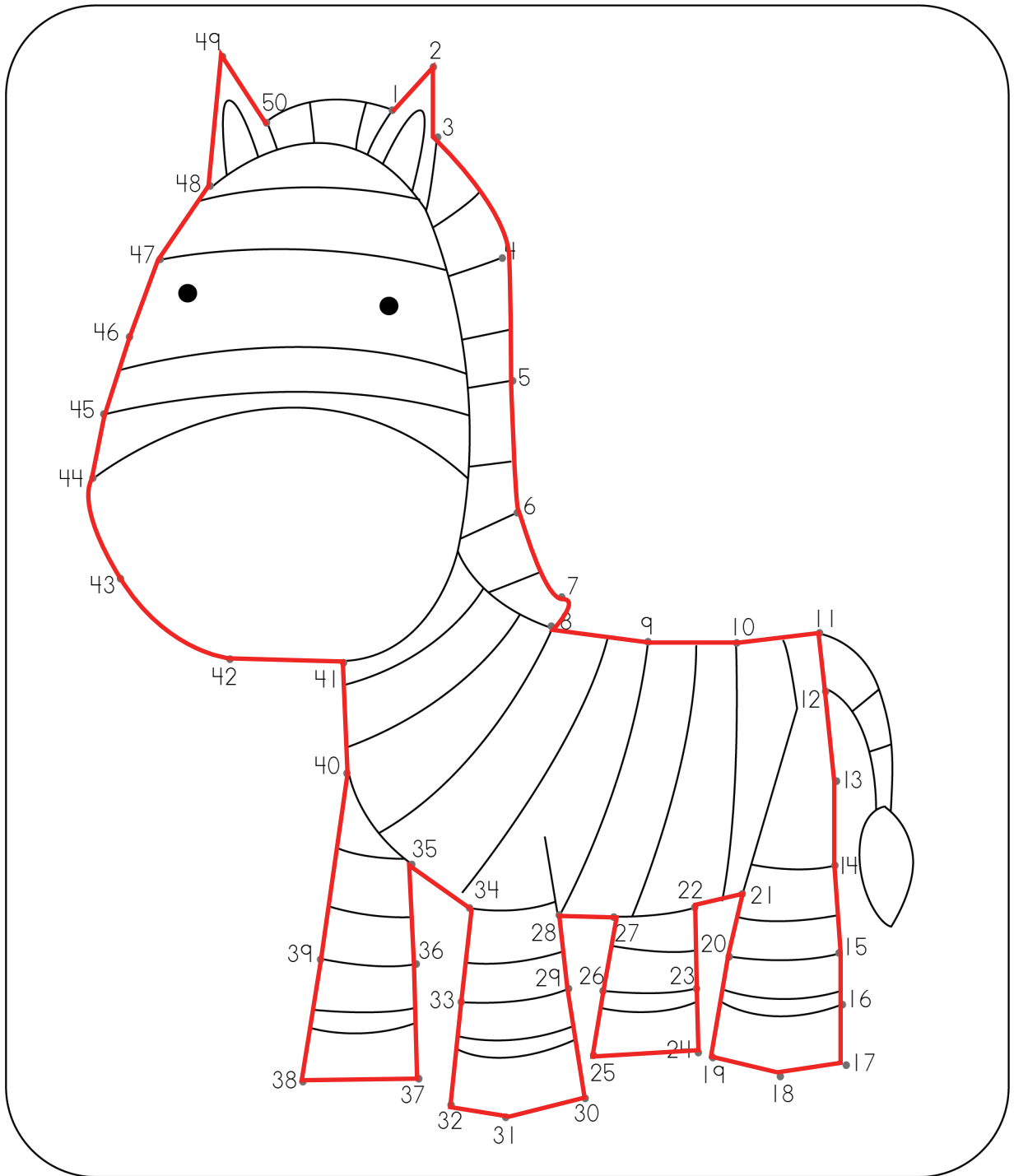

Connect the dots to complete the picture. Then trace the word and colour the picture.

cat

