

5/24 (row2 col1)

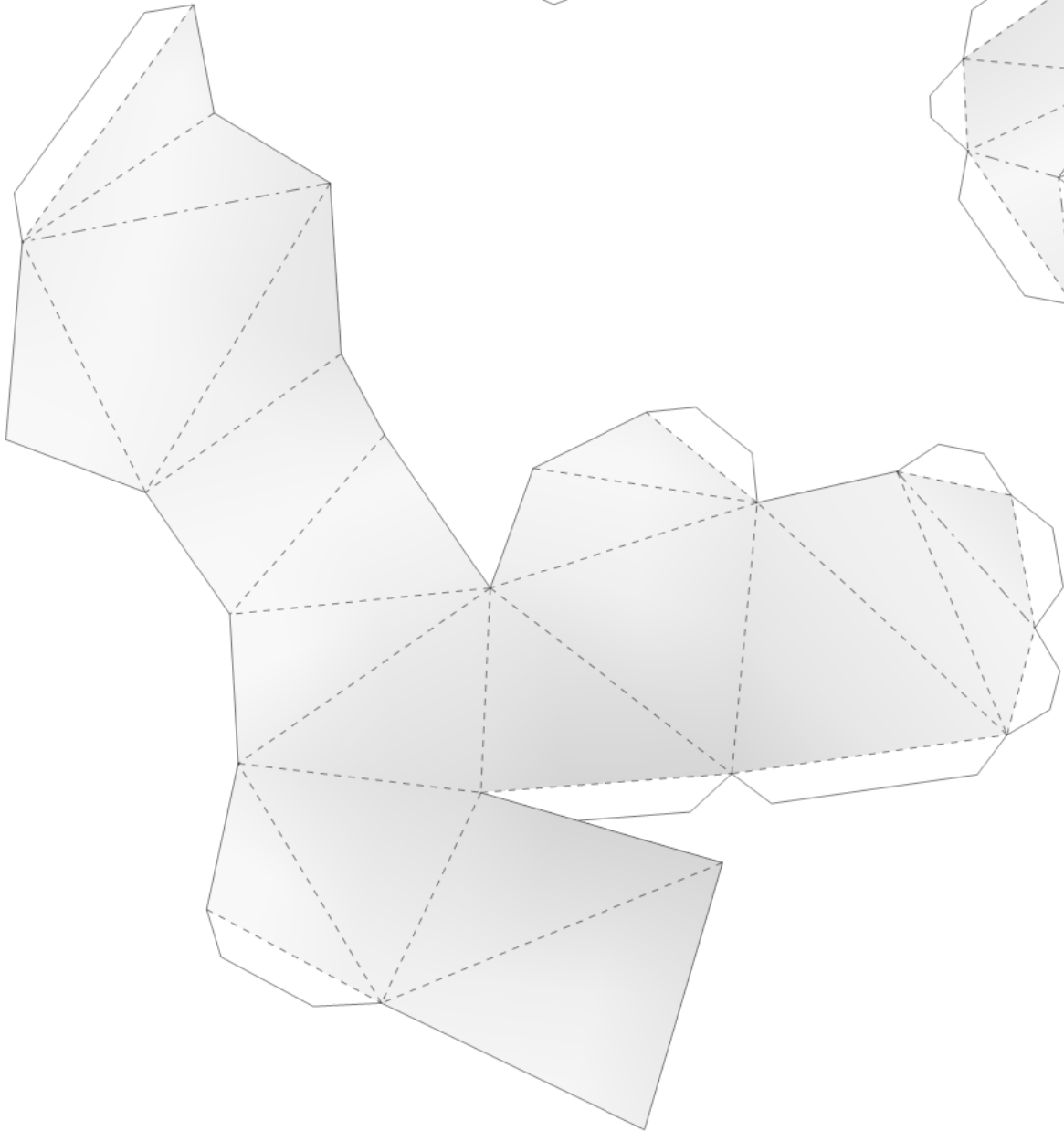

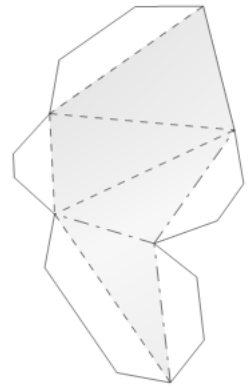

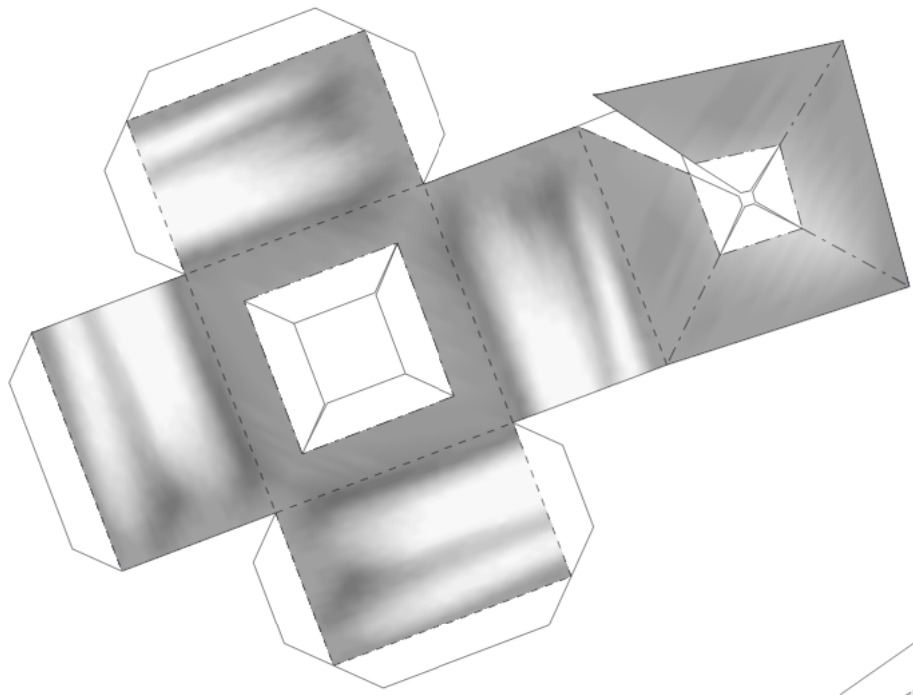

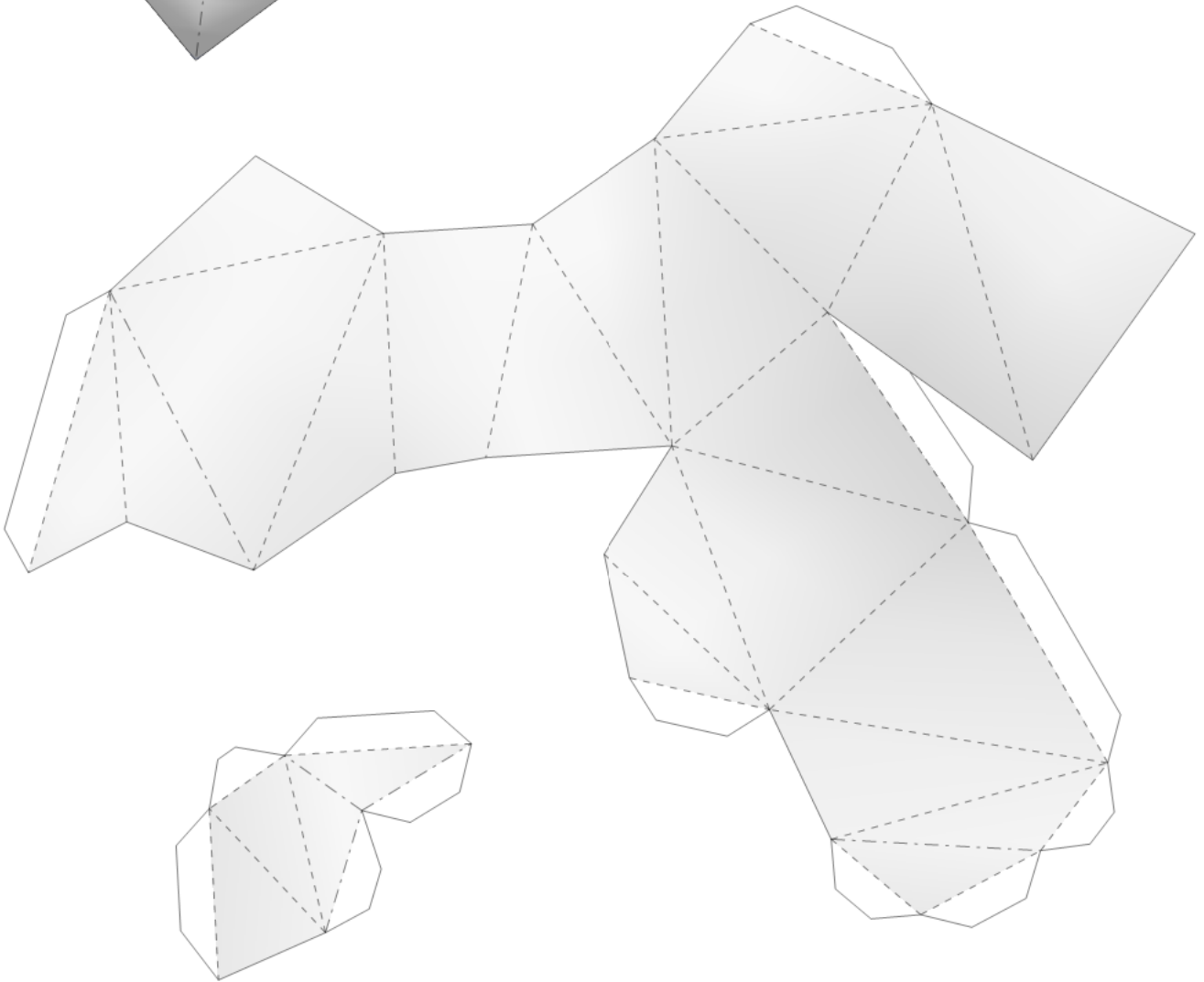
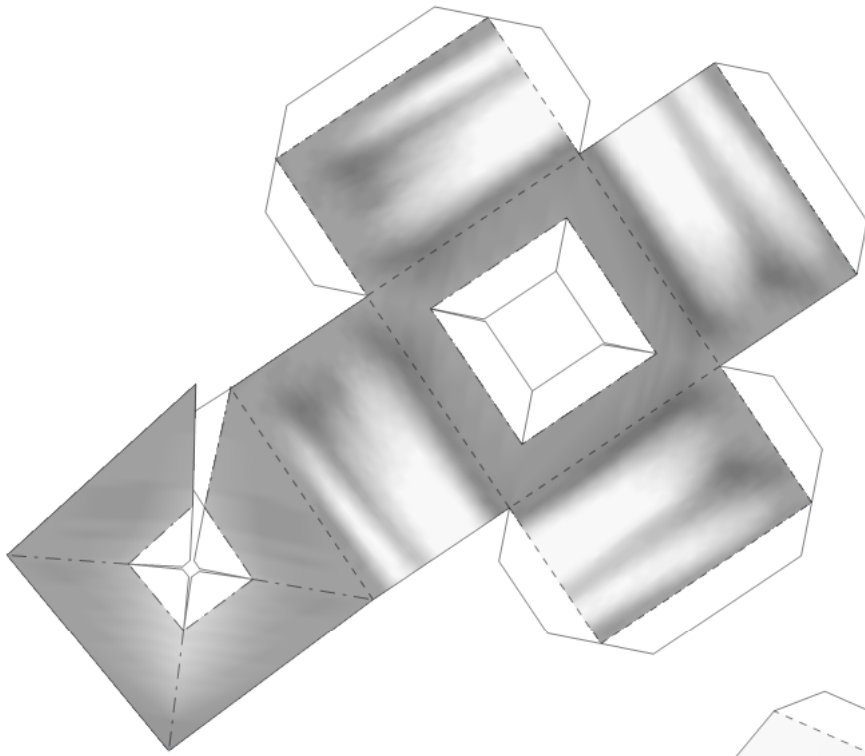
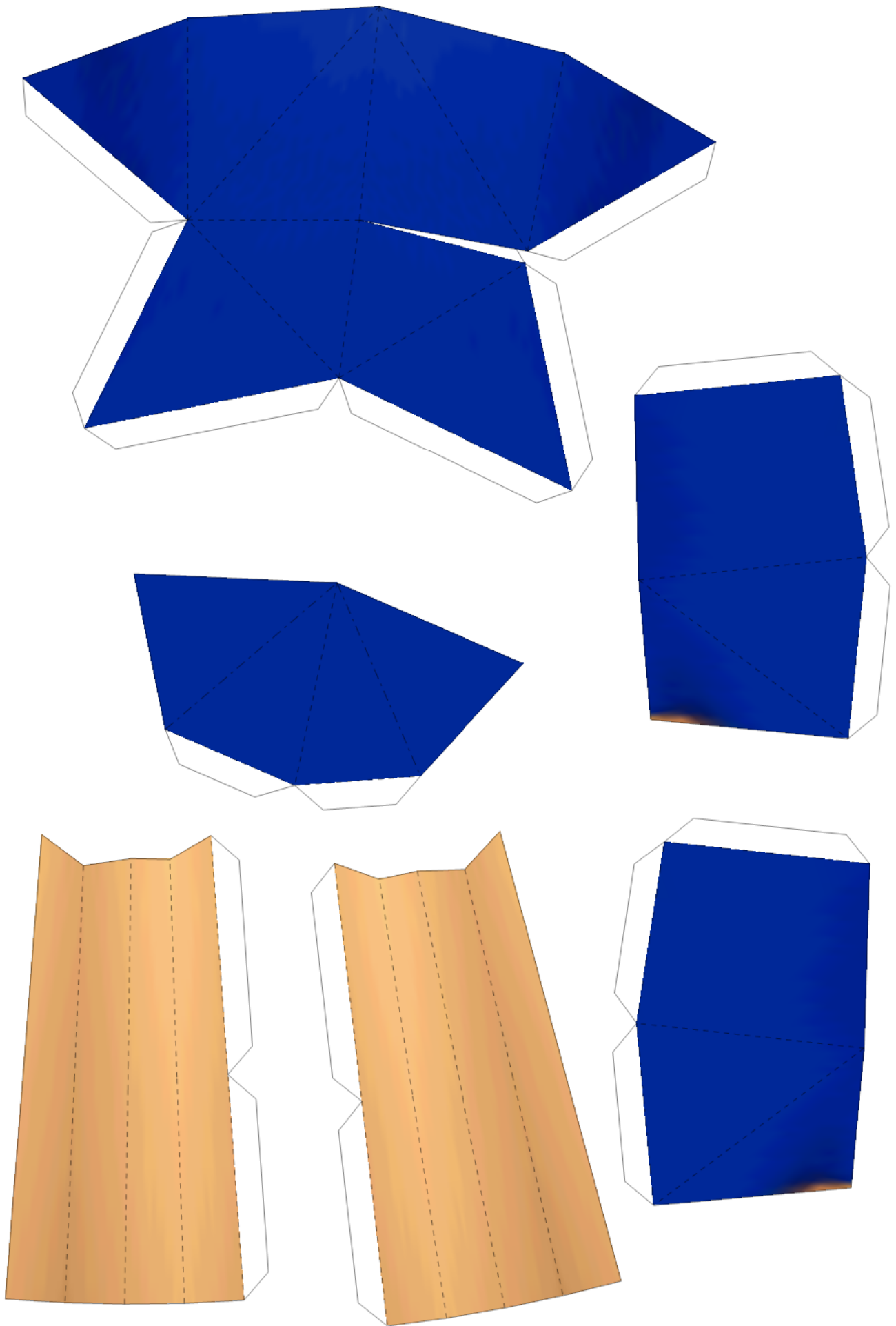

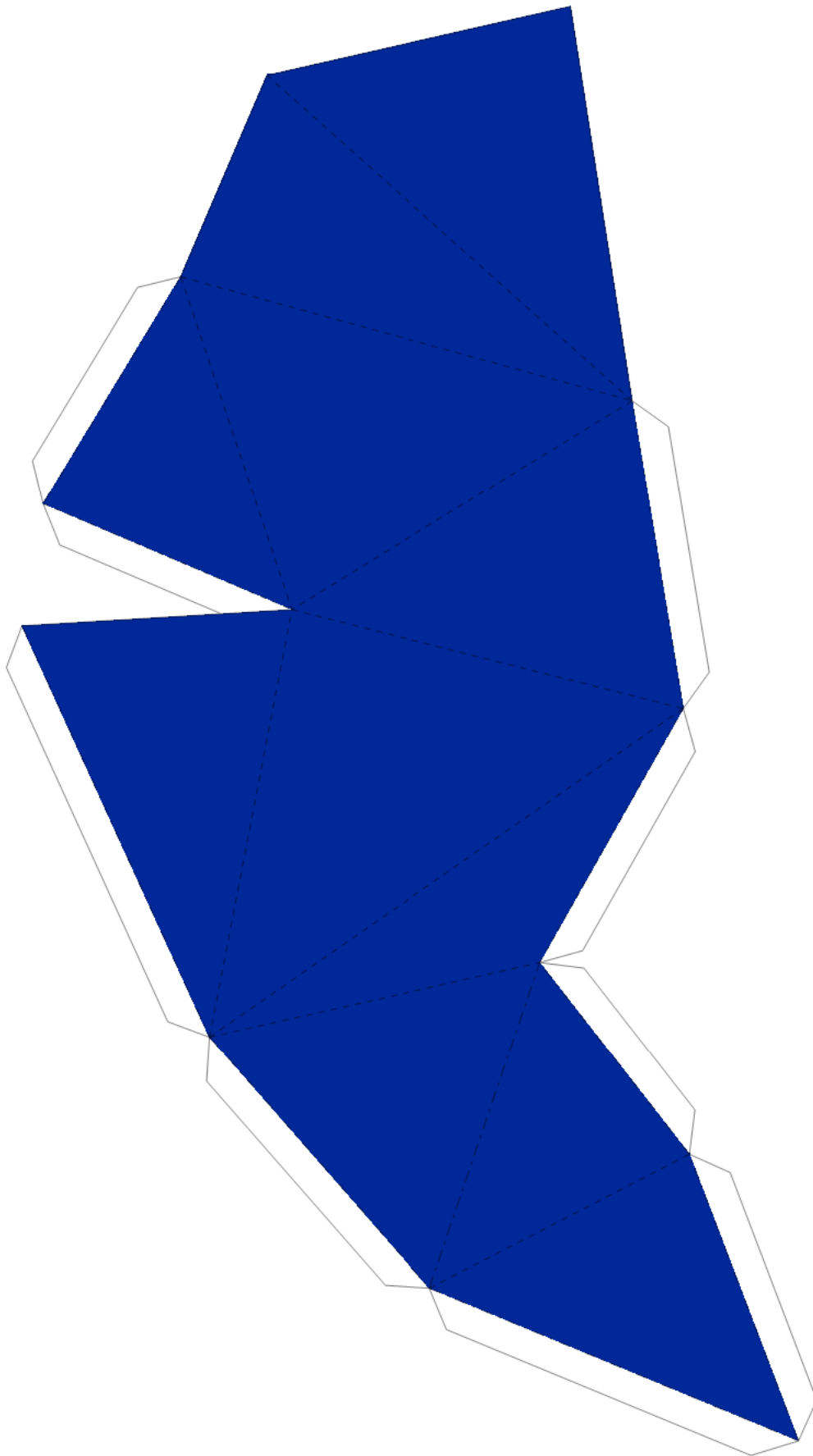

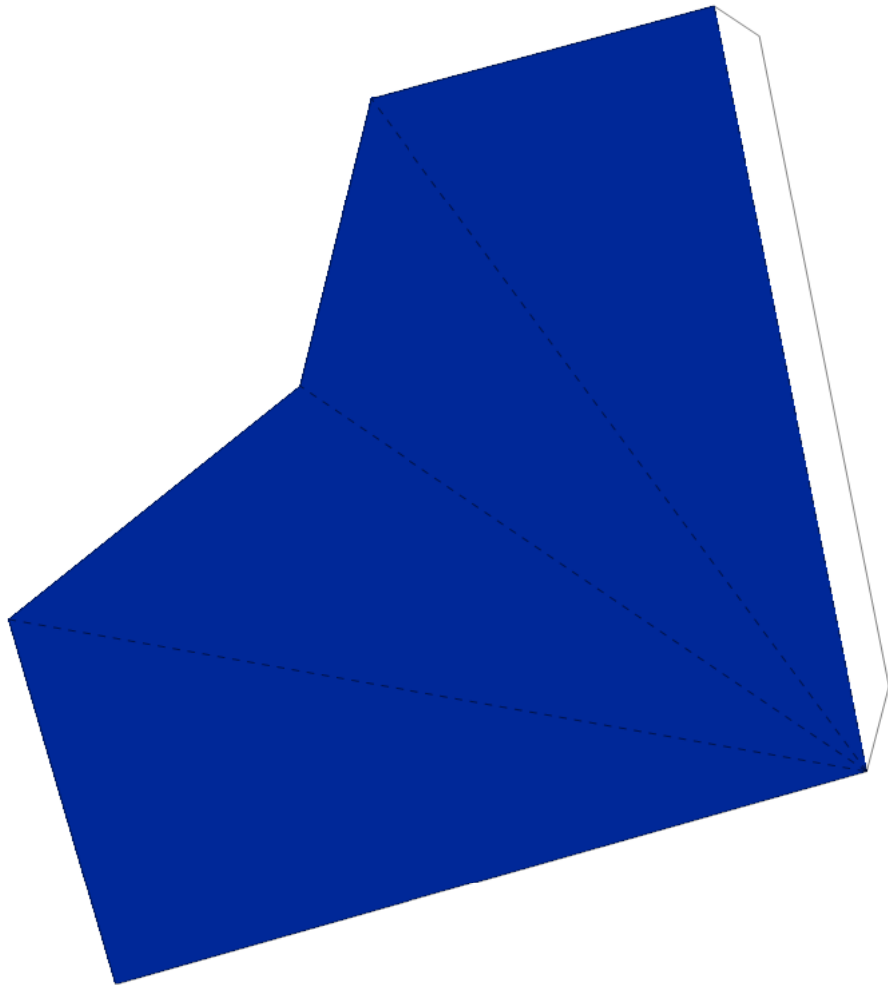







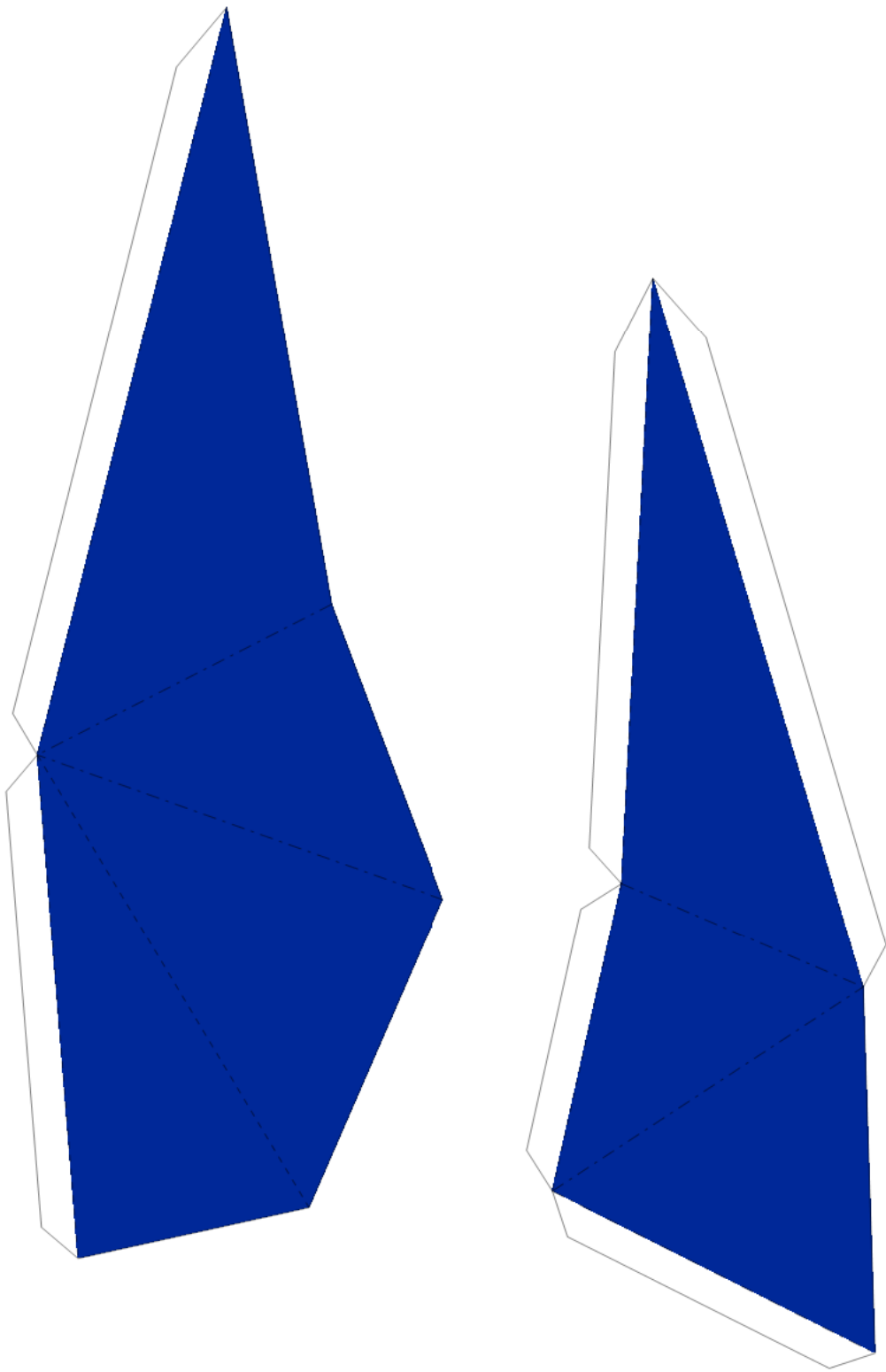

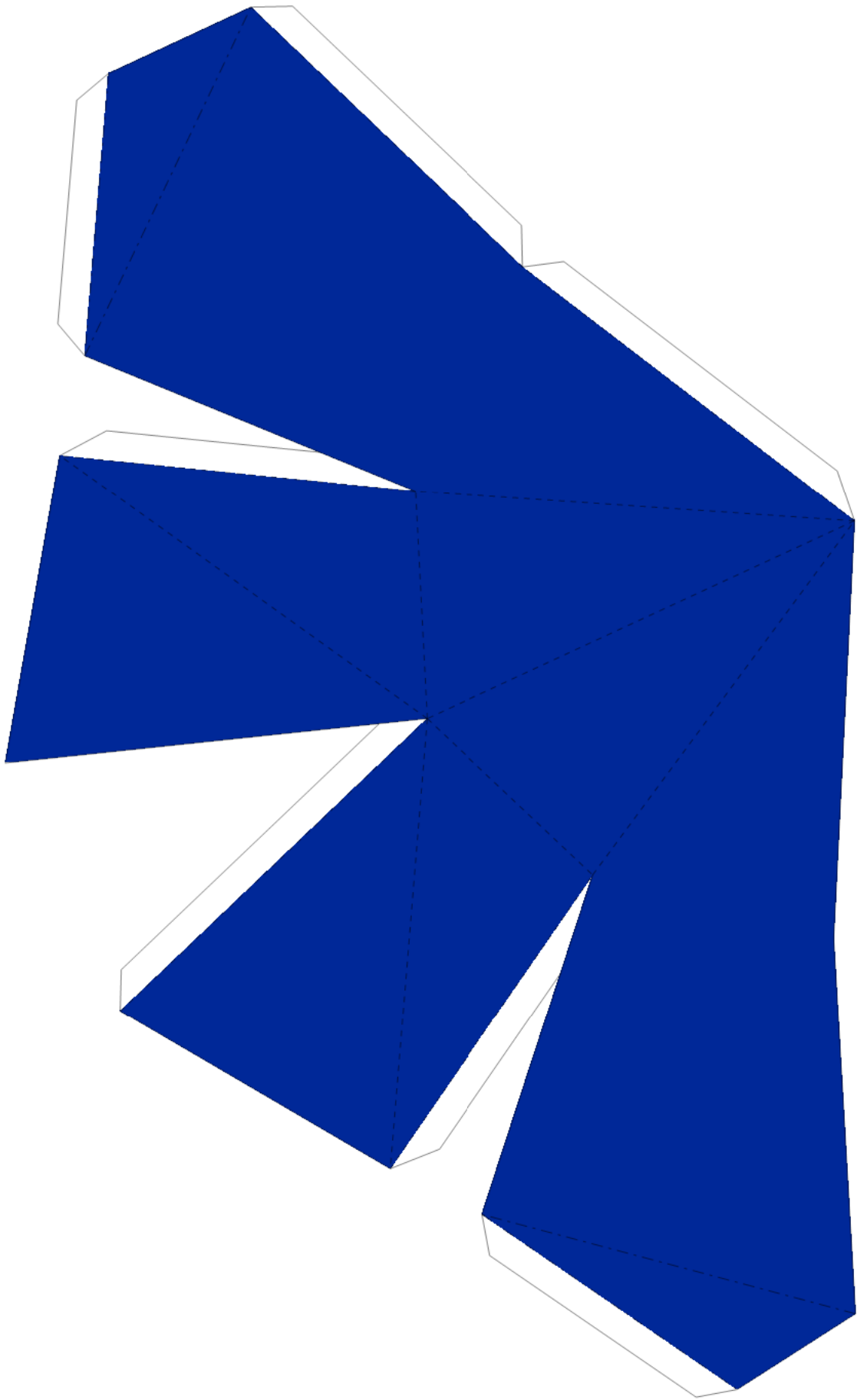

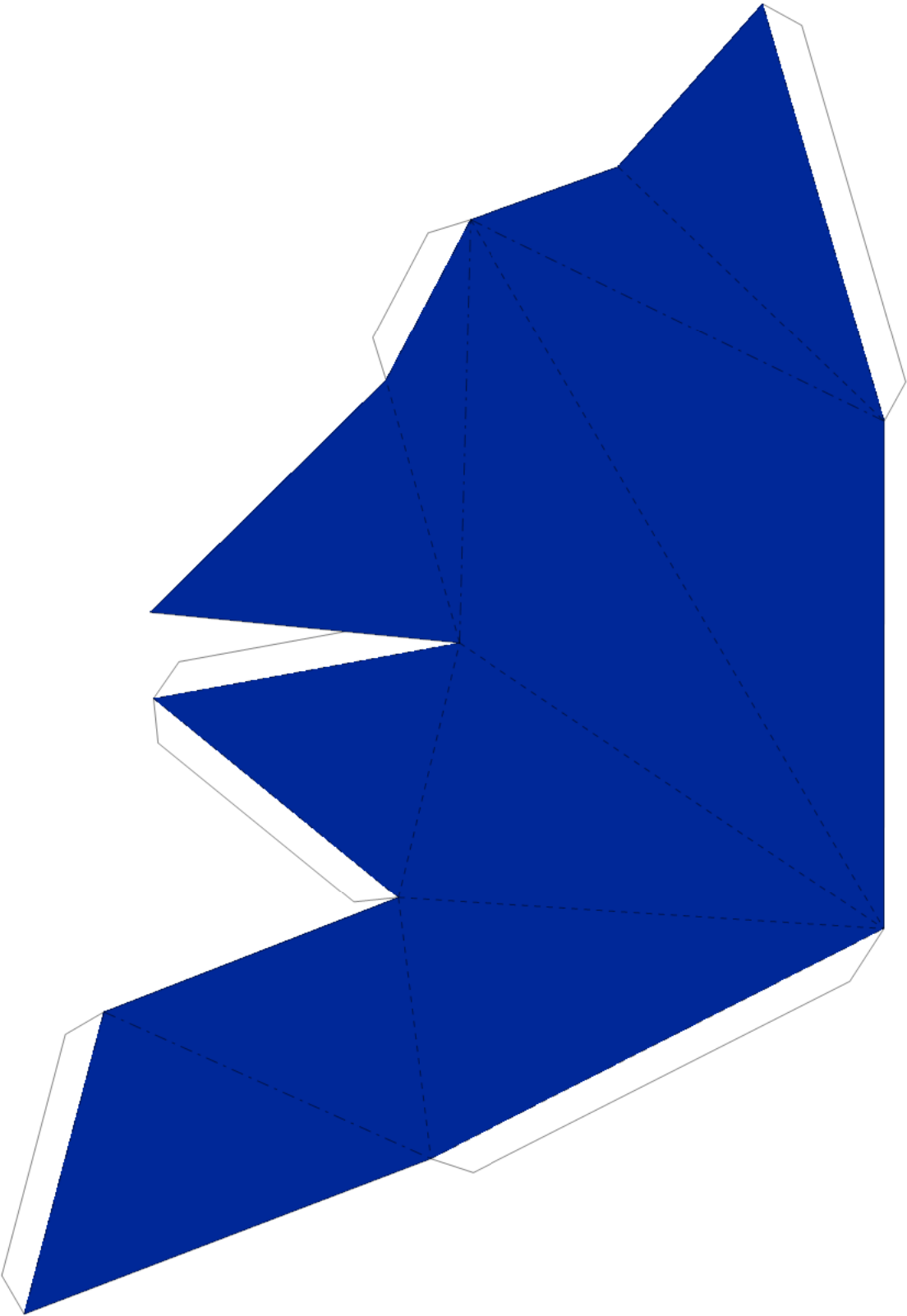



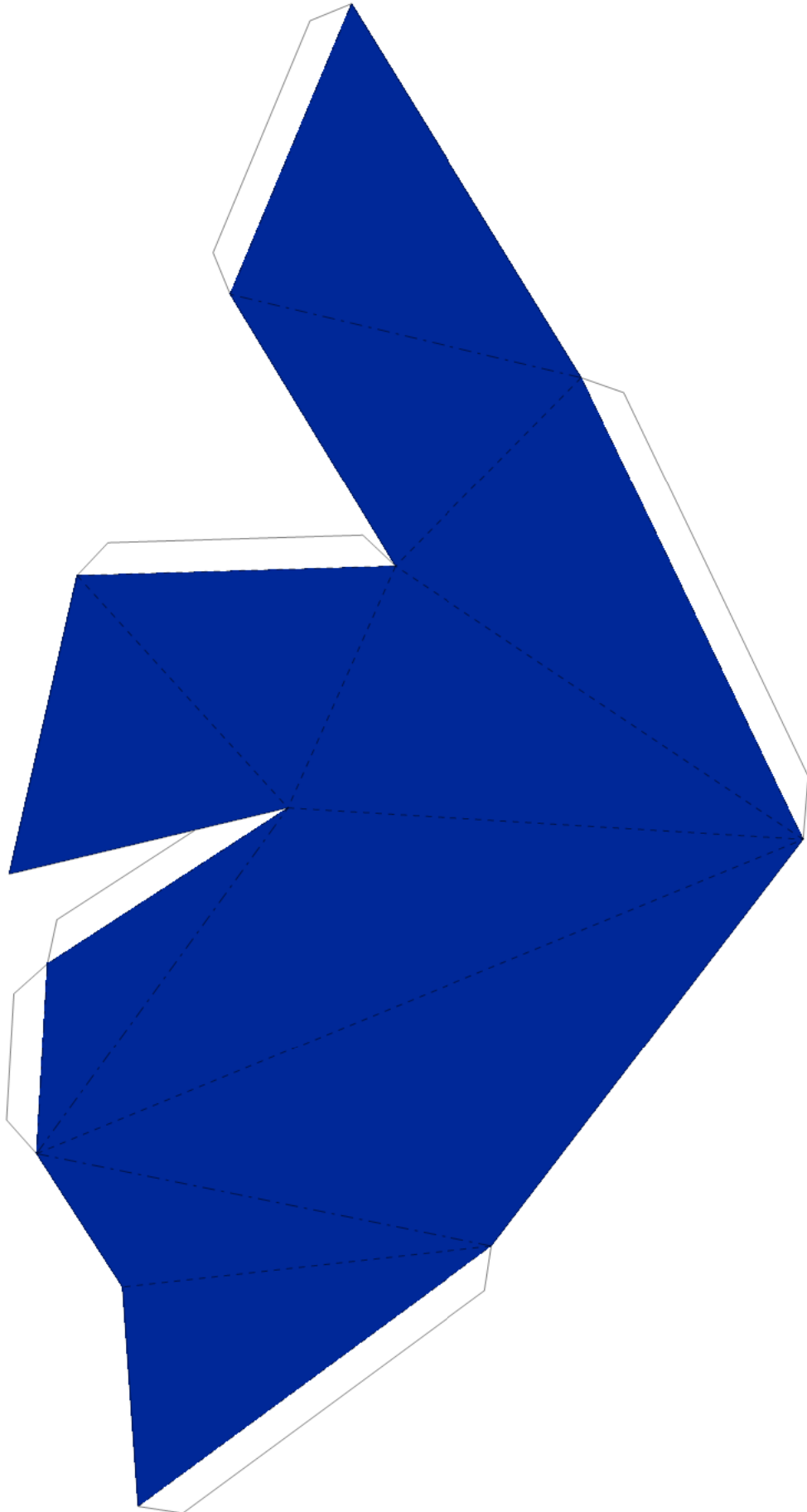



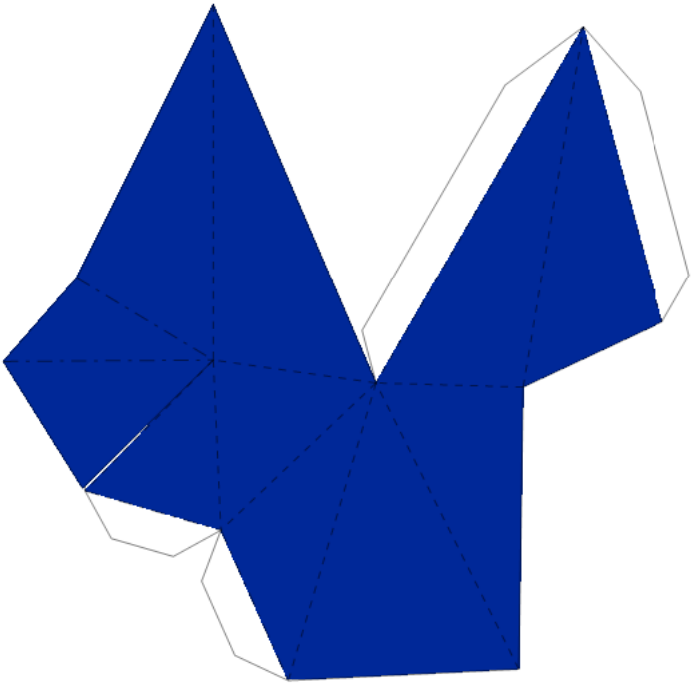

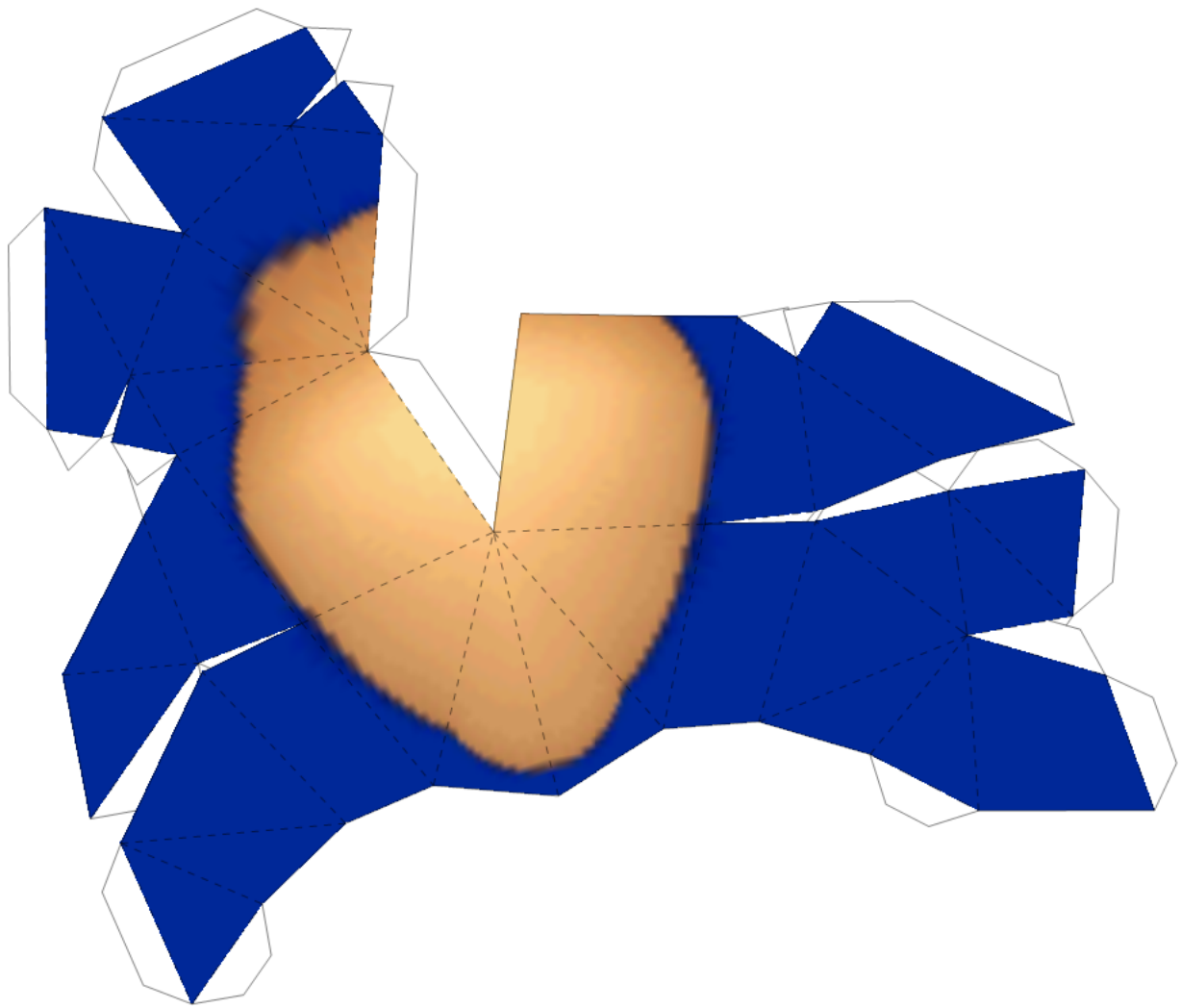

(optional)

